

ABBREVIATIONS	ELECTRICAL NOTES	JURISDICTION NOTES																									
<p>A AMPERE AC ALTERNATING CURRENT BLDG BUILDING CONC CONCRETE DC DIRECT CURRENT EGC EQUIPMENT GROUNDING CONDUCTOR (E) EXISTING EMT ELECTRICAL METALLIC TUBING FSB FIRE SET-BACK GALV GALVANIZED GEC GROUNDING ELECTRODE CONDUCTOR GND GROUND HDG HOT DIPPED GALVANIZED I CURRENT Imp CURRENT AT MAX POWER Isc SHORT CIRCUIT CURRENT kVA KILOVOLT AMPERE kW KILOWATT LBW LOAD BEARING WALL MIN MINIMUM (N) NEW NEUT NEUTRAL NTS NOT TO SCALE OC ON CENTER PL PROPERTY LINE POI POINT OF INTERCONNECTION PV PHOTOVOLTAIC SCH SCHEDULE S STAINLESS STEEL STC STANDARD TESTING CONDITIONS TYP TYPICAL UPS UNINTERRUPTIBLE POWER SUPPLY V VOLT Vmp VOLTAGE AT MAX POWER Voc VOLTAGE AT OPEN CIRCUIT W WATT 3R NEMA 3R, RAIN TIGHT</p>	<p>1. THIS SYSTEM IS GRID-INTERTIED VIA A UL-LISTED POWER-CONDITIONING INVERTER. 2. A NATIONALLY - RECOGNIZED TESTING LABORATORY SHALL LIST ALL EQUIPMENT IN COMPLIANCE WITH ART. 110.3. 3. WHERE ALL TERMINALS OF THE DISCONNECTING MEANS MAY BE ENERGIZED IN THE OPEN POSITION, A SIGN WILL BE PROVIDED WARNING OF THE HAZARDS PER ART. 690.17. 4. EACH UNGROUNDED CONDUCTOR OF THE MULTIWIRED BRANCH CIRCUIT WILL BE IDENTIFIED BY PHASE AND SYSTEM PER ART. 210.5. 5. CIRCUITS OVER 250V TO GROUND SHALL COMPLY WITH ART. 250.97, 250.92(B). 6. DC CONDUCTORS EITHER DO NOT ENTER BUILDING OR ARE RUN IN METALLIC RACEWAYS OR ENCLOSURES TO THE FIRST ACCESSIBLE DC DISCONNECTING MEANS PER ART. 690.31(E). 7. ALL WIRES SHALL BE PROVIDED WITH STRAIN RELIEF AT ALL ENTRY INTO BOXES AS REQUIRED BY UL LISTING. 8. MODULE FRAMES SHALL BE GROUNDED AT THE UL - LISTED LOCATION PROVIDED BY THE MANUFACTURER USING UL LISTED GROUNDING HARDWARE. 9. MODULE FRAMES, RAIL, AND POSTS SHALL BE BONDED WITH EQUIPMENT GROUND CONDUCTORS.</p>	<p style="text-align: center;">VICINITY MAP</p>  <p style="text-align: center;">INDEX</p> <table border="1"> <tr><td>Sheet 1</td><td>COVER SHEET</td></tr> <tr><td>Sheet 2</td><td>SITE PLAN</td></tr> <tr><td>Sheet 3</td><td>CONDUIT PHOTOS</td></tr> <tr><td>Sheet 4</td><td>STRUCTURAL VIEWS</td></tr> <tr><td>Sheet 5</td><td>UPLIFT CALCULATIONS</td></tr> <tr><td>Sheet 6</td><td>THREE LINE DIAGRAM</td></tr> <tr><td colspan="2">Cutsheets Attached</td></tr> </table>		Sheet 1	COVER SHEET	Sheet 2	SITE PLAN	Sheet 3	CONDUIT PHOTOS	Sheet 4	STRUCTURAL VIEWS	Sheet 5	UPLIFT CALCULATIONS	Sheet 6	THREE LINE DIAGRAM	Cutsheets Attached											
Sheet 1	COVER SHEET																										
Sheet 2	SITE PLAN																										
Sheet 3	CONDUIT PHOTOS																										
Sheet 4	STRUCTURAL VIEWS																										
Sheet 5	UPLIFT CALCULATIONS																										
Sheet 6	THREE LINE DIAGRAM																										
Cutsheets Attached																											
<p style="text-align: center;">LICENSE</p>	<p style="text-align: center;">GENERAL NOTES</p> <p>1. ALL WORK SHALL COMPLY WITH THE 2018 IBC AND 2018 IRC. 2. ALL ELECTRICAL WORK SHALL COMPLY WITH THE 2017 NATIONAL ELECTRIC CODE.</p>	<table border="1"> <thead> <tr> <th>REV</th> <th>BY</th> <th>DATE</th> <th>COMMENTS</th> </tr> </thead> <tbody> <tr> <td>REV A</td> <td>JC</td> <td>10/27/22</td> <td>Included photos</td> </tr> <tr> <td>*</td> <td>*</td> <td>*</td> <td>*</td> </tr> <tr> <td>*</td> <td>*</td> <td>*</td> <td>*</td> </tr> <tr> <td>*</td> <td>*</td> <td>*</td> <td>*</td> </tr> <tr> <td>*</td> <td>*</td> <td>*</td> <td>*</td> </tr> </tbody> </table>		REV	BY	DATE	COMMENTS	REV A	JC	10/27/22	Included photos	*	*	*	*	*	*	*	*	*	*	*	*	*	*	*	*
REV	BY	DATE	COMMENTS																								
REV A	JC	10/27/22	Included photos																								
*	*	*	*																								
*	*	*	*																								
*	*	*	*																								
*	*	*	*																								

CONFIDENTIAL - THE INFORMATION HEREIN CONTAINED SHALL NOT BE USED FOR THE BENEFIT OF ANYONE EXCEPT TESLA INC., NOR SHALL IT BE DISCLOSED IN WHOLE OR IN PART TO OTHERS OUTSIDE THE RECIPIENT'S ORGANIZATION, EXCEPT IN CONNECTION WITH THE SALE AND USE OF THE RESPECTIVE TESLA EQUIPMENT, WITHOUT THE WRITTEN PERMISSION OF TESLA INC.

JOB NUMBER: JB-0381606 00

MOUNTING SYSTEM: ZS Comp V4 w Flashing-Insert

MODULES: (51) Tesla # T400H

INVERTER: Multiple Inverters

CUSTOMER: Cyril Chen
46 Mark St
Portsmouth, NH 03801

3015297364

DESCRIPTION: 20.4 KW PV ARRAY

PAGE NAME: COVER SHEET

DESIGN: Jesslyn Cabero

SHEET: 1 REV: A DATE: 10/27/2022



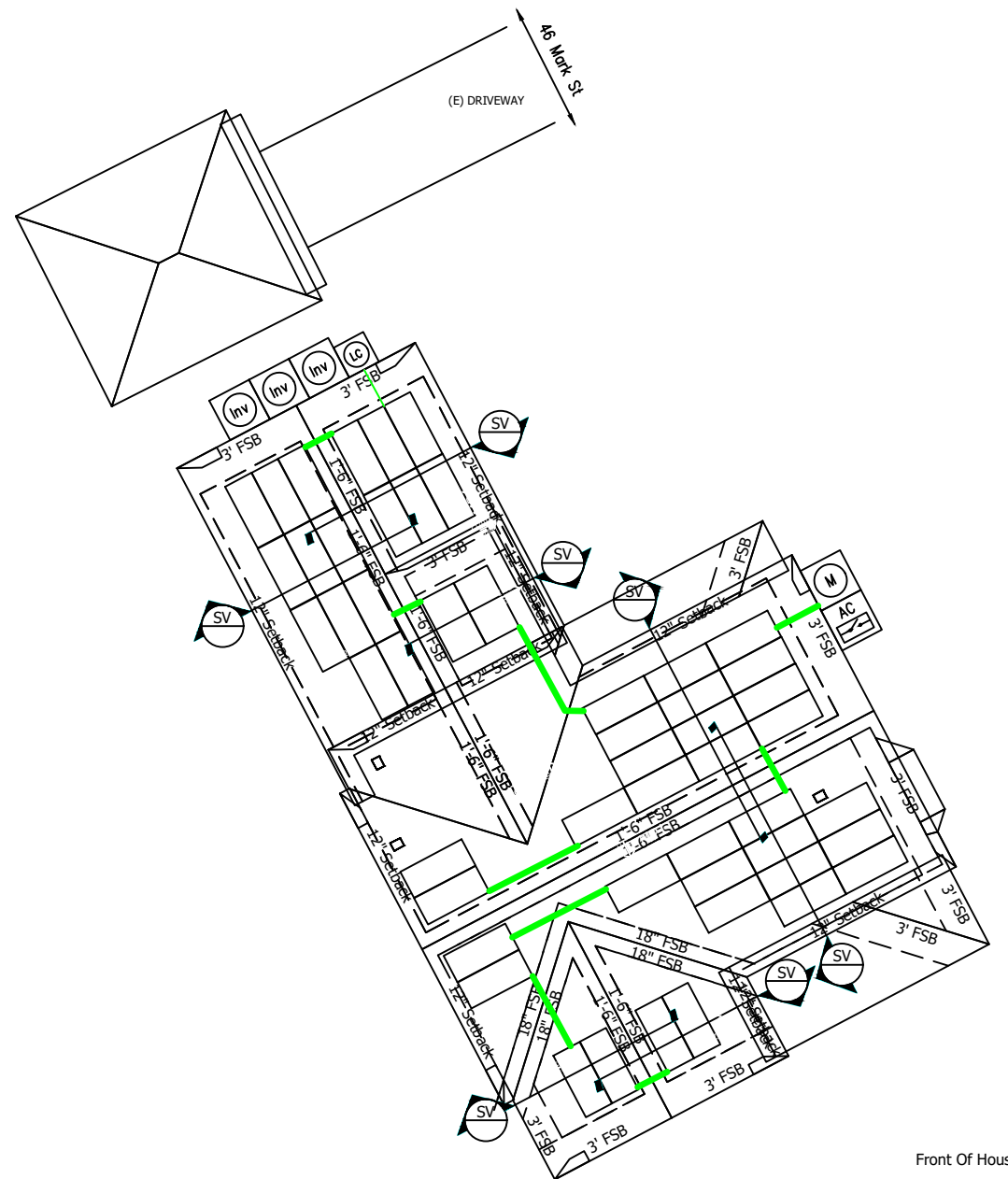

MP1	PITCH: 39° (10:12) ARRAY PITCH: 39° (10:12) AZIMUTH: 152 ARRAY AZIMUTH: 152 MATERIAL: Comp Shingle STORY: 2 Stories
MP2	PITCH: 39° (10:12) ARRAY PITCH: 39° (10:12) AZIMUTH: 332 ARRAY AZIMUTH: 332 MATERIAL: Comp Shingle STORY: 2 Stories
MP3	PITCH: 39° (10:12) ARRAY PITCH: 39° (10:12) AZIMUTH: 242 ARRAY AZIMUTH: 242 MATERIAL: Comp Shingle STORY: 2 Stories
MP4	PITCH: 39° (10:12) ARRAY PITCH: 39° (10:12) AZIMUTH: 62 ARRAY AZIMUTH: 62 MATERIAL: Comp Shingle STORY: 2 Stories
MP5	PITCH: 39° (10:12) ARRAY PITCH: 39° (10:12) AZIMUTH: 62 ARRAY AZIMUTH: 62 MATERIAL: Comp Shingle STORY: 2 Stories
MP6	PITCH: 39° (10:12) ARRAY PITCH: 39° (10:12) AZIMUTH: 242 ARRAY AZIMUTH: 242 MATERIAL: Comp Shingle STORY: 2 Stories

LEGEND

- (E) UTILITY METER & WARNING LABEL
- INVERTER W/ INTEGRATED DC DISCO & WARNING LABELS
- AUTOMATIC RELAY
- DC DISCONNECT & WARNING LABELS
- AC DISCONNECT & WARNING LABELS
- DC JUNCTION/COMBINER BOX & LABELS
- ENERGY STORAGE SYSTEM FOR STAND ALONE OPERATION
- DISTRIBUTION PANEL & LABELS
- LOAD CENTER & WARNING LABELS
- DEDICATED PV SYSTEM METER
- RAPID SHUTDOWN
- STANDOFF LOCATIONS
- CONDUIT RUN ON EXTERIOR
- CONDUIT RUN ON INTERIOR
- GATE/FENCE
- HEAT PRODUCING VENTS ARE RED
- INTERIOR EQUIPMENT IS DASHED

TOTAL ARRAY AREA (SF): 1106
 TOTAL ROOF AREA (SF): 4054
 TOTAL ARRAY AREA IS ≈ 27.28
 PERCENT OF TOTAL ROOF AREA

SITE PLAN

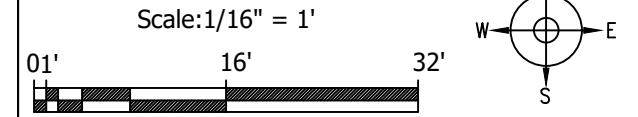

CONFIDENTIAL - THE INFORMATION HEREIN CONTAINED SHALL NOT BE USED FOR THE BENEFIT OF ANYONE EXCEPT TESLA INC., NOR SHALL IT BE DISCLOSED IN WHOLE OR IN PART TO OTHERS OUTSIDE THE RECIPIENT'S ORGANIZATION, EXCEPT IN CONNECTION WITH THE SALE AND USE OF THE RESPECTIVE TESLA EQUIPMENT, WITHOUT THE WRITTEN PERMISSION OF TESLA INC.

JOB NUMBER: JB-0381606 00
 MOUNTING SYSTEM: ZS Comp V4 w Flashing-Insert
 MODULES: (51) Tesla # T400H
 INVERTER: Multiple Inverters

CUSTOMER: Cyril Chen
 46 Mark St
 Portsmouth, NH 03801
 3015297364

DESCRIPTION: 20.4 KW PV ARRAY
 PAGE NAME: SITE PLAN

DESIGN: Jesslyn Cabero
 SHEET: 2 REV: A DATE: 10/27/2022



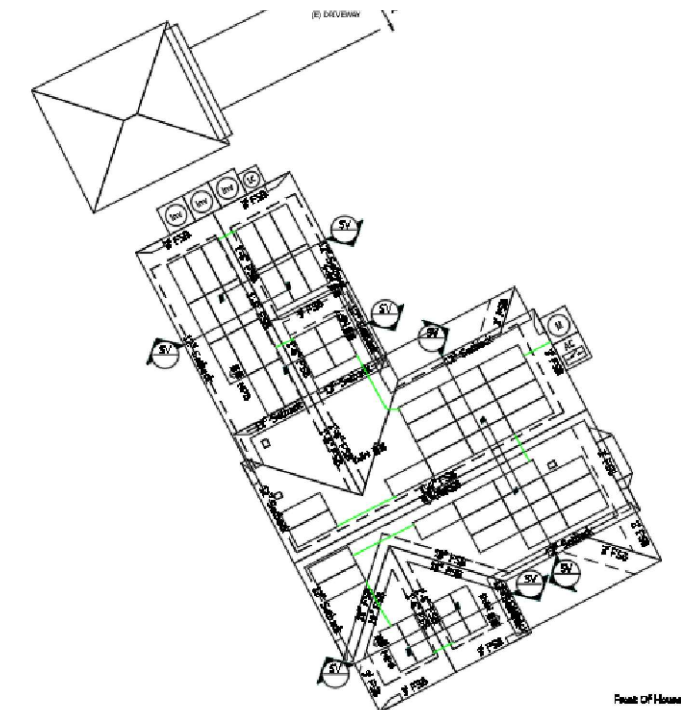
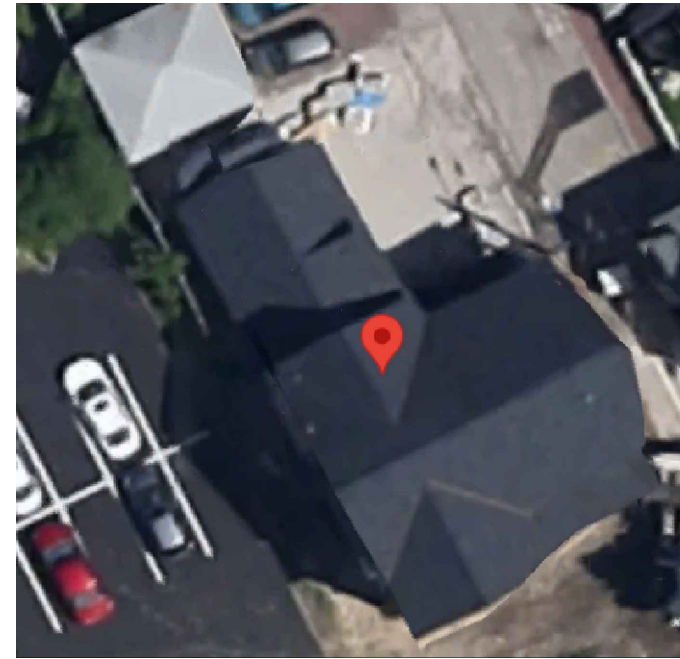
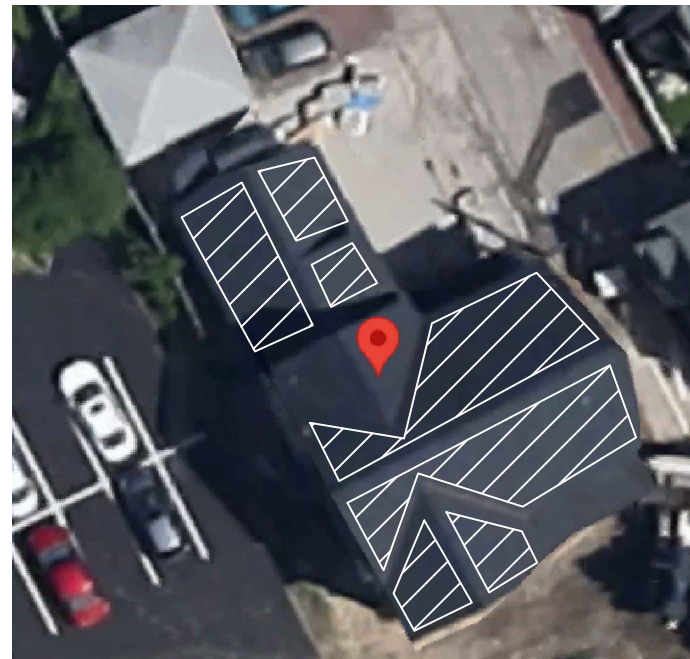
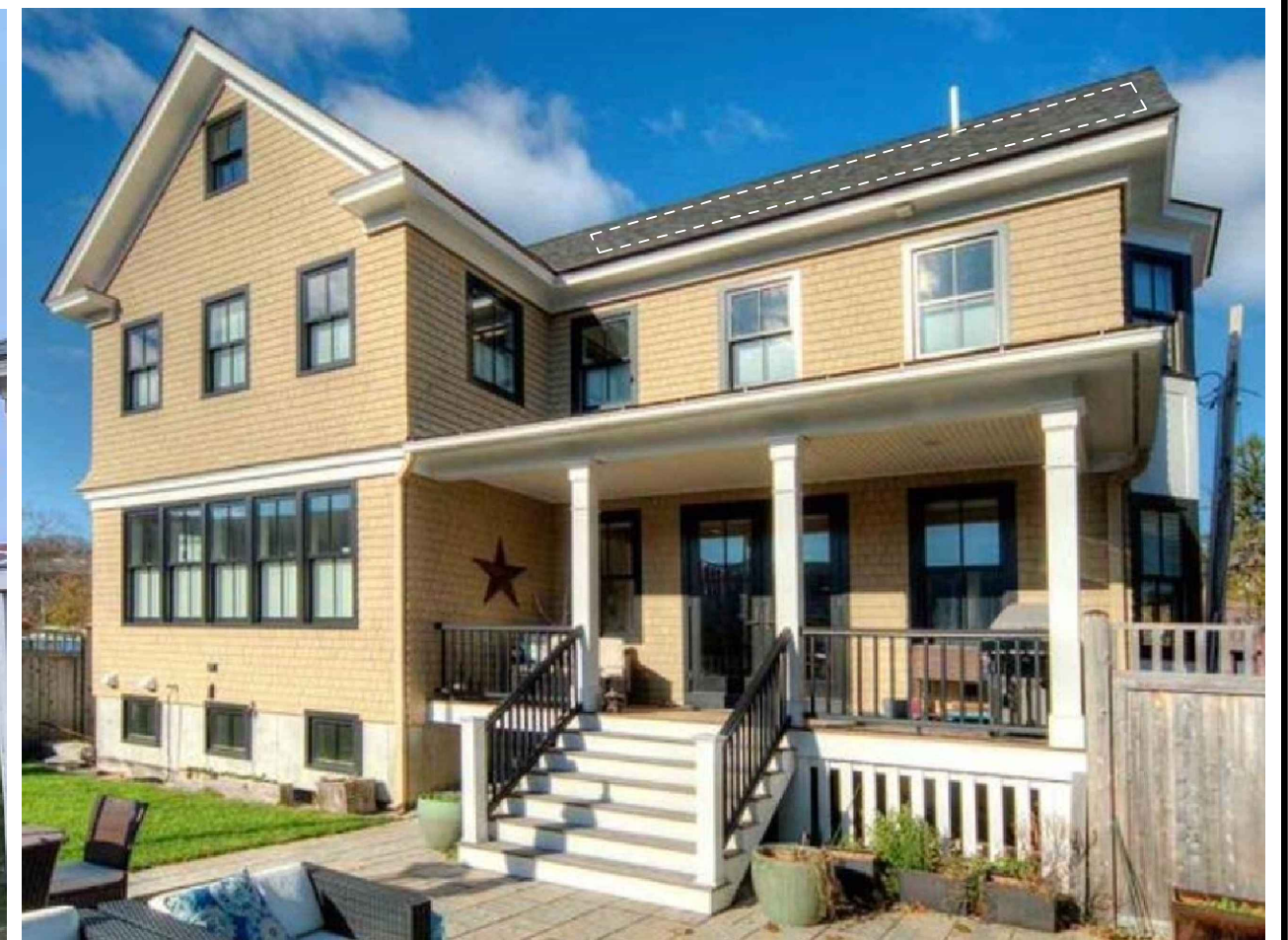

CONFIDENTIAL - THE INFORMATION HEREIN CONTAINED SHALL NOT BE USED FOR THE BENEFIT OF ANYONE EXCEPT TESLA INC., NOR SHALL IT BE DISCLOSED IN WHOLE OR IN PART TO OTHERS OUTSIDE THE RECIPIENT'S ORGANIZATION, EXCEPT IN CONNECTION WITH THE SALE AND USE OF THE RESPECTIVE TESLA EQUIPMENT, WITHOUT THE WRITTEN PERMISSION OF TESLA INC.

JOB NUMBER: JB-0381606 00
 MOUNTING SYSTEM:
 ZS Comp V4 w Flashing-Insert
 MODULES:
 (51) Tesla # T400H
 INVERTER:
 Multiple Inverters

CUSTOMER:
 Cyril Chen
 46 Mark St
 Portsmouth, NH 03801
 3015297364

DESCRIPTION:
 20.4 KW PV ARRAY
 PAGE NAME:
 CONDUIT PHOTOS

DESIGN:
 Jesslyn Cabero
 SHEET: 3 REV: A DATE: 10/27/2022

TESLA

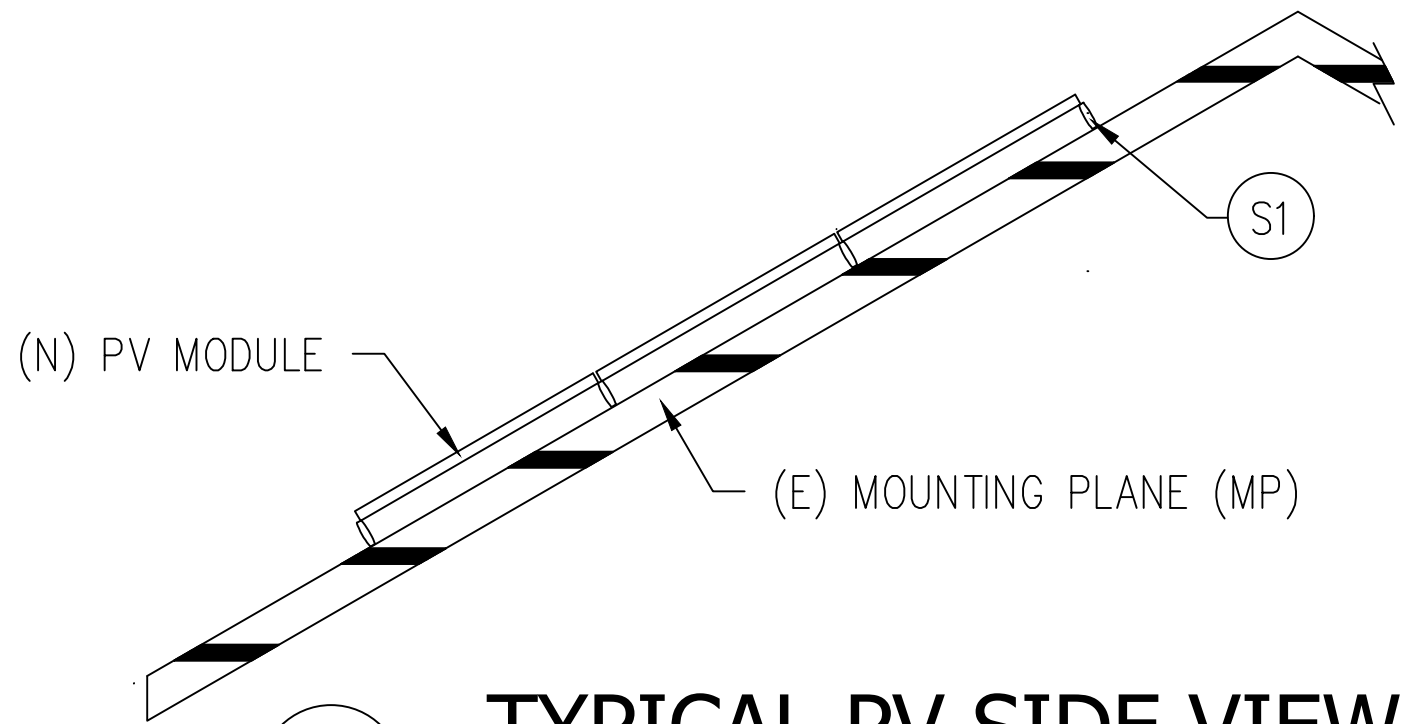

SV **TYPICAL PV SIDE VIEW**
NTS

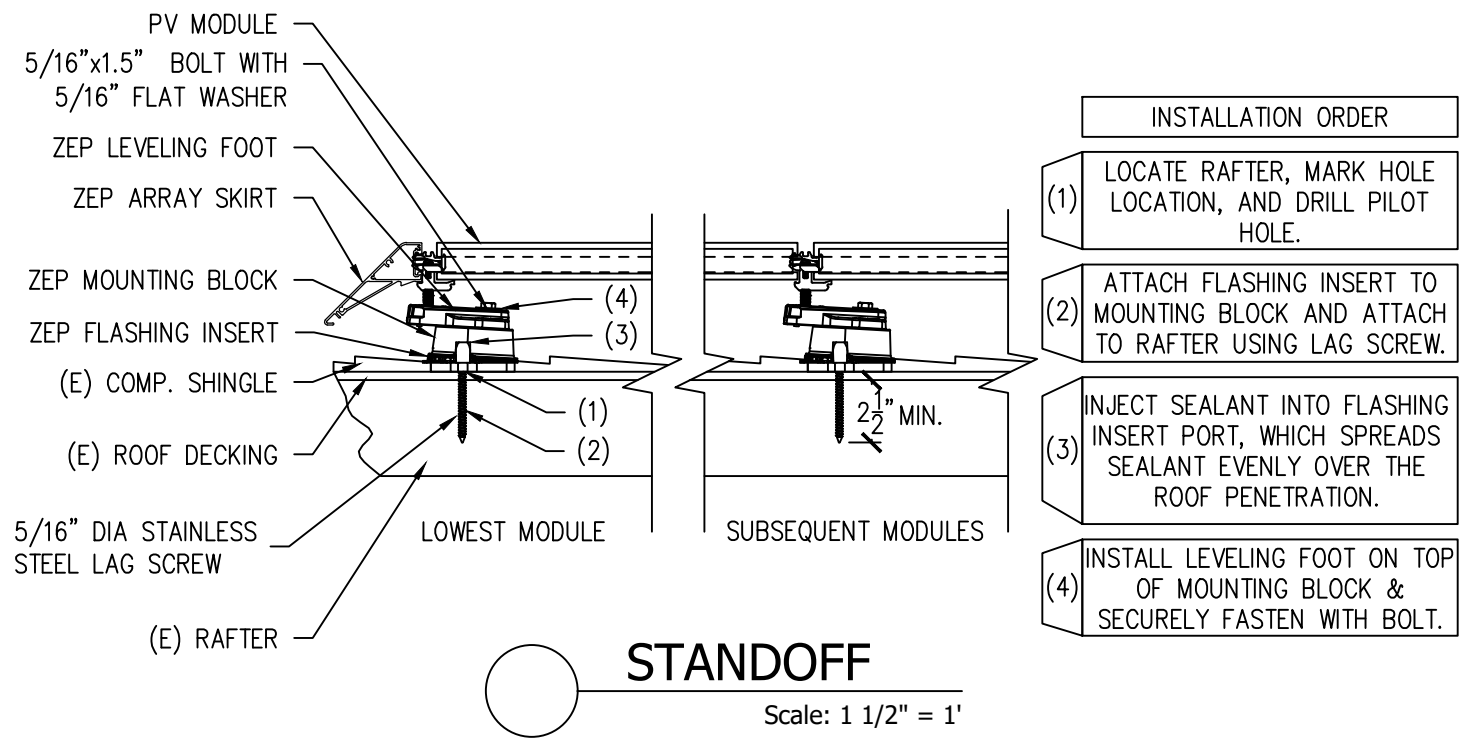

CONFIDENTIAL - THE INFORMATION HEREIN CONTAINED SHALL NOT BE USED FOR THE BENEFIT OF ANYONE EXCEPT TESLA INC., NOR SHALL IT BE DISCLOSED IN WHOLE OR IN PART TO OTHERS OUTSIDE THE RECIPIENT'S ORGANIZATION, EXCEPT IN CONNECTION WITH THE SALE AND USE OF THE RESPECTIVE TESLA EQUIPMENT, WITHOUT THE WRITTEN PERMISSION OF TESLA INC.

JOB NUMBER: JB-0381606 00
 MOUNTING SYSTEM: ZS Comp V4 w Flashing-Insert
 MODULES: (51) Tesla # T400H
 INVERTER: Multiple Inverters

CUSTOMER:
 Cyril Chen
 46 Mark St
 Portsmouth, NH 03801
 3015297364

DESCRIPTION:
 20.4 KW PV ARRAY
 PAGE NAME:
 STRUCTURAL VIEWS

DESIGN:
 Jesslyn Cabero
 SHEET: 4 REV: A DATE: 10/27/2022



Jobsite Specific Design Criteria			
Design Code		ASCE 7-16	
Risk Category		II	Table 1.5-1
Ultimate Wind Speed	V-Ult	100	Fig. 1609A
Exposure Category		C	Section 26.7
Ground Snow Load	pg	50	Table 7-1
Edge Zone Width	a	8.7 ft	Fig. 30.3-2A to I

MP Specific Design Information							
MP Name	MP1	MP2	MP3	MP4	MP5	MP6	MP7
Roofing	Comp Shingle	Comp Shingle	Comp Shingle	Comp Shingle	Comp Shingle	Comp Shingle	Comp Shingle
Standoff	ZS Comp V4 w Flashing-Insert	ZS Comp V4 w Flashing-Insert	ZS Comp V4 w Flashing-Insert	ZS Comp V4 w Flashing-Insert	ZS Comp V4 w Flashing-Insert	ZS Comp V4 w Flashing-Insert	ZS Comp V4 w Flashing-Insert
Pitch	39	39	39	39	39	39	14
SL/RL: PV	17.9	17.9	17.9	17.9	17.9	17.9	32.3
SL/RL: Non-PV	33.0	33.0	33.0	33.0	33.0	33.0	34.7

Standoff Spacing and Layout							
MP Name	MP1	MP2	MP3	MP4	MP5	MP6	MP7
Landscape X-Spacing	72	72	72	72	72	72	48
Landscape X-Cantilever	24	24	24	24	24	24	23
Landscape Y-Spacing	41	41	41	41	41	41	41
Landscape Y-Cantilever	-	-	-	-	-	-	-
Portrait X-Spacing	48	48	48	48	48	48	DQ
Portrait X-Cantilever	21	21	21	21	21	21	DQ
Portrait Y-Spacing	74	74	74	74	74	74	DQ
Portrait Y-Cantilever	-	-	-	-	-	-	DQ
Layout	Staggered	Staggered	Staggered	Staggered	Staggered	Staggered	Staggered

X and Y are maximums that are always relative to the structure framing that supports the PV. X is across rafters and Y is along rafters.

CONFIDENTIAL - THE INFORMATION HEREIN CONTAINED SHALL NOT BE USED FOR THE BENEFIT OF ANYONE EXCEPT TESLA INC., NOR SHALL IT BE DISCLOSED IN WHOLE OR IN PART TO OTHERS OUTSIDE THE RECIPIENT'S ORGANIZATION, EXCEPT IN CONNECTION WITH THE SALE AND USE OF THE RESPECTIVE TESLA EQUIPMENT, WITHOUT THE WRITTEN PERMISSION OF TESLA INC.

JOB NUMBER: JB-0381606 00

MOUNTING SYSTEM:
ZS Comp V4 w Flashing-Insert

MODULES:
(51) Tesla # T400H

INVERTER:
Multiple Inverters

CUSTOMER:
Cyril Chen
46 Mark St
Portsmouth, NH 03801

3015297364

DESCRIPTION:
20.4 KW PV ARRAY

PAGE NAME:
UPLIFT CALCULATIONS

DESIGN:
Jesslyn Cabero

SHEET: 5 REV: A DATE: 10/27/2022

TESLA

MAIN PANEL SPECS	GENERAL NOTES	INVERTER SPECS	MODULE SPECS	LICENSE
Panel Number: NoLabel Meter Number: S72334518 Underground Service Entrance	Inv 1: DC Ungrounded Inv 2: DC Ungrounded Inv 3: DC Ungrounded Tie-In: Supply Side Connection	INV 1 - (1) 7.6 kW Tesla Inc 1538000-00-F (240V) INV 2 - (1) 7.6 kW Tesla Inc 1538000-00-F (240V) INV 3 - (1) 3.8 kW Tesla Inc 1534000-00-F (240V)	- (51) Tesla # T400H PV Module, 400W, 371.5 PTC, 40MM, Black Frame, MC4/MC4-EV02, ZEP, 1000V Voc: 45.3 Vpmax: 37.13 Isc AND Imp ARE SHOWN IN THE DC STRINGS IDENTIFIER	

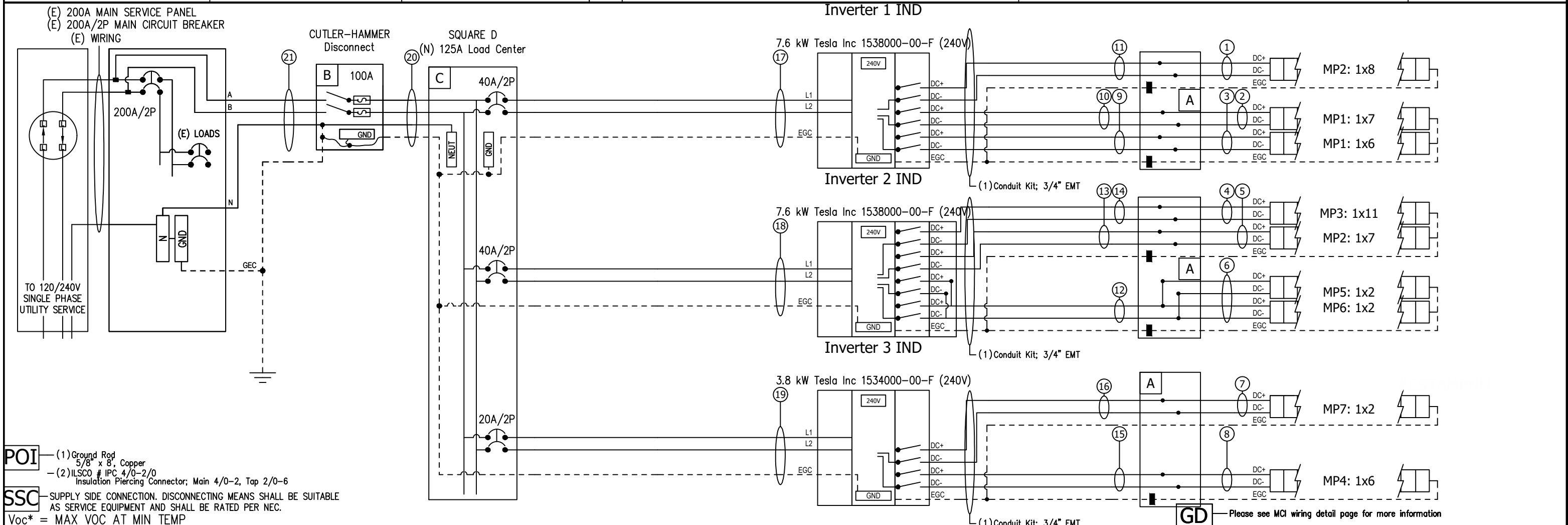

POI - (1) Ground Rod 5/8" x 8", Copper
 - (2) ILSCO # IPC 4/0-2/0 Insulation Piercing Connector; Main 4/0-2, Tap 2/0-6

SSC - SUPPLY SIDE CONNECTION. DISCONNECTING MEANS SHALL BE SUITABLE AS SERVICE EQUIPMENT AND SHALL BE RATED PER NEC.

Voc* = MAX VOC AT MIN TEMP

AC	DC
20 (1) AWG #3, THWN-2, Black (1) AWG #3, THWN-2, Red (1) AWG #8, THWN-2, Green EGC Vmp = 240 VAC Imp=80 AAC - (1) Conduit Kit; 1" EMT 21 (1) AWG #3, THWN-2, Black (1) AWG #3, THWN-2, Red (1) AWG #6, Solid Bare Copper GEC Vmp = 240 VAC Imp=80 AAC - (1) Conduit Kit; 1" EMT	7 (2) PV Wire, AWG 10 (1) AWG #10, Solid Bare Copper EGC Voc* = 105.03 VDC Isc = 11.14 ADC Vmp = 74.26 VDC Imp=10.77 ADC 8 (2) PV Wire, AWG 10 (1) AWG #10, Solid Bare Copper EGC Voc* = 315.1 VDC Isc = 11.14 ADC Vmp = 222.78 VDC Imp=10.77 ADC 9 (1) AWG #10, THWN-2, Black (1) AWG #10, THWN-2, Red (1) AWG #10, THHN/THWN-2, Green EGC Voc* = 577.68 VDC Isc = 11.14 ADC Vmp = 408.43 VDC Imp=10.77 ADC 10 (1) AWG #10, THWN-2, Black (1) AWG #10, THWN-2, Red (1) AWG #10, THHN/THWN-2, Green EGC Voc* = 315.1 VDC Isc = 11.14 ADC Vmp = 222.78 VDC Imp=10.77 ADC 11 (1) AWG #10, THWN-2, Black (1) AWG #10, THWN-2, Red (1) AWG #10, THHN/THWN-2, Green EGC Voc* = 420.13 VDC Isc = 11.14 ADC Vmp = 297.04 VDC Imp=10.77 ADC 12 (1) AWG #8, THWN-2, Black (1) AWG #10, THHN/THWN-2, Green EGC Voc* = 105.03 VDC Isc = 11.14 ADC Vmp = 74.26 VDC Imp=10.77 ADC
B (1) CUTLER-HAMMER # DG223NRB Disconnect; 100A, 240Vac, Fusible, NEMA 3R - (1) CUTLER-HAMMER # DG100NB Ground/Neutral Kit; 60-100A, General Duty (DG) - (1) CUTLER-HAMMER # DG100RB Class R Fuse Kit - (2) FERRAZ SHAWMUT # TR100R Fuse; 100A, 250V, Class RK5 PV BACKFEED OCP C (1) SQUARE D # HOM1224L125PRB Load Center; 125A, Convertible, NEMA3R, 12sp/24Cir, 120v/240v, 10kAIC, Surface - (2) SQUARE D # HOM240 Breaker; 40A/2P, 2 Spaces - (1) SQUARE D # HOM220 Breaker; 20A/2P, 2 Spaces	AC DC A (3) Tesla 4J 4-String Combiner Box UNFUSED, GROUNDED, Black, Diag DIN Rail with Bracket/ Cord Grip (20) Tesla MCI, 650V, 12A GD - Please see MCI wiring detail page for more information 1 (2) PV Wire, AWG 10 (1) AWG #10, Solid Bare Copper EGC Voc* = 420.13 VDC Isc = 11.14 ADC Vmp = 297.04 VDC Imp=10.77 ADC 2 (2) PV Wire, AWG 10 (1) AWG #10, Solid Bare Copper EGC Voc* = 367.61 VDC Isc = 11.14 ADC Vmp = 259.91 VDC Imp=10.77 ADC 3 (2) PV Wire, AWG 10 (1) AWG #10, Solid Bare Copper EGC Voc* = 315.1 VDC Isc = 11.14 ADC Vmp = 222.78 VDC Imp=10.77 ADC 4 (2) PV Wire, AWG 10 (1) AWG #10, Solid Bare Copper EGC Voc* = 577.68 VDC Isc = 11.14 ADC Vmp = 408.43 VDC Imp=10.77 ADC 5 (2) PV Wire, AWG 10 (1) AWG #10, Solid Bare Copper EGC Voc* = 367.61 VDC Isc = 11.14 ADC Vmp = 259.91 VDC Imp=10.77 ADC 6 (4) PV Wire, AWG 10 (1) AWG #10, Solid Bare Copper EGC Voc* = 105.03 VDC Isc = 11.14 ADC Vmp = 74.26 VDC Imp=10.77 ADC

CONFIDENTIAL - THE INFORMATION HEREIN CONTAINED SHALL NOT BE USED FOR THE BENEFIT OF ANYONE EXCEPT TESLA INC. NOR SHALL IT BE DISCLOSED IN WHOLE OR IN PART TO OTHERS OUTSIDE THE RECIPIENT'S ORGANIZATION, EXCEPT IN CONNECTION WITH THE SALE AND USE OF THE RESPECTIVE TESLA EQUIPMENT, WITHOUT THE WRITTEN PERMISSION OF TESLA INC.	JOB NUMBER: JB-0381606 00 MOUNTING SYSTEM: ZS Comp V4 w Flashing-Insert MODULES: (51) Tesla # T400H INVERTER: Multiple Inverters	CUSTOMER: Cyril Chen 46 Mark St Portsmouth, NH 03801 3015297364	DESCRIPTION: 20.4 KW PV ARRAY PAGE NAME: THREE LINE DIAGRAM	DESIGN: Jesslyn Cabero SHEET: 6 REV: A DATE: 10/27/2022	
----------------------------------------------------------------------------------------------------------------------------------------------------------------------------------------------------------------------------------------------------------------------------------------------------------------------------------------	-------------------------------------------------------------------------------------------------------------------------------------------	------------------------------------------------------------------------------	--------------------------------------------------------------------	----------------------------------------------------------------	--

SOLAR PV SYSTEM EQUIPPED WITH RAPID SHUTDOWN

TURN RAPID SHUTDOWN SWITCH TO THE "OFF"
POSITION TO SHUT DOWN PV SYSTEM AND REDUCE
SHOCK HAZARD IN THE ARRAY

- Address: 46 Mark St

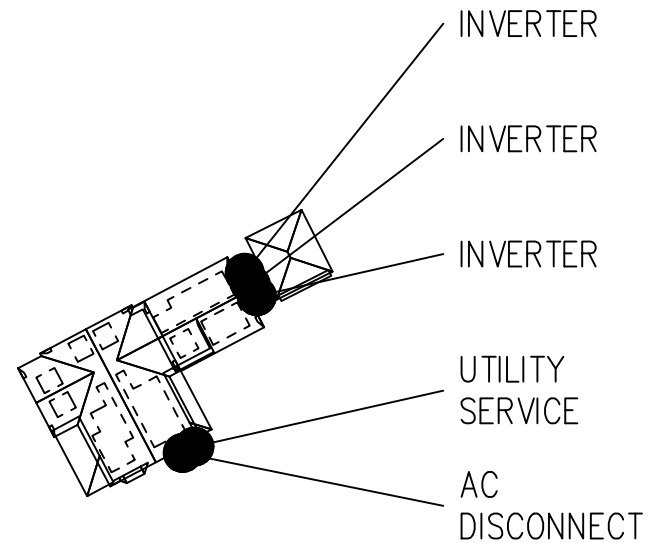

OPERATING VOLTAGE = 240V

JB-0381606-00

CONFIDENTIAL - THE INFORMATION HEREIN
CONTAINED SHALL NOT BE USED FOR THE
BENEFIT OF ANYONE EXCEPT TESLA INC., NOR
SHALL IT BE DISCLOSED IN WHOLE OR IN
PART TO OTHERS OUTSIDE THE RECIPIENT'S
ORGANIZATION, EXCEPT IN CONNECTION WITH
THE SALE AND USE OF THE RESPECTIVE
TESLA EQUIPMENT, WITHOUT THE WRITTEN
PERMISSION OF TESLA INC.

JOB NUMBER: JB-0381606 00

MOUNTING SYSTEM:
ZS Comp V4 w Flashing-Insert

MODULES:
(51) Tesla # T400H

INVERTER:
Multiple Inverters

CUSTOMER:
Cyril Chen
46 Mark St
Portsmouth, NH 03801

3015297364

DESCRIPTION:
20.4 KW PV ARRAY

PAGE NAME:
SITE PLAN PLACARD

DESIGN:
Jesslyn Cabero

SHEET: 7 REV: A DATE: 10/27/2022

TESLA

WARNING: PHOTOVOLTAIC POWER SOURCE

Label Location:
(C)(CB)(JB)
Per Code:
NEC 690.31.G.3

PHOTOVOLTAIC DC
DISCONNECT

Label Location:
(DC) (INV)
Per Code:
NEC 690.13.B

WARNING

ELECTRIC SHOCK HAZARD
DO NOT TOUCH TERMINALS
TERMINALS ON BOTH LINE AND
LOAD SIDES MAY BE ENERGIZED
IN THE OPEN POSITION

Label Location:
(AC)(POI)
Per Code:
NEC 690.13.B

WARNING

ELECTRIC SHOCK HAZARD
THE DC CONDUCTORS OF THIS
PHOTOVOLTAIC SYSTEM ARE
UNGROUNDDED AND
MAY BE ENERGIZED

Label Location:
(DC) (INV)

MAXIMUM VOLTAGE
MAXIMUM CIRCUIT CURRENT
MAX RATED OUTPUT CURRENT
OF THE CHARGE CONTROLLER
OR DC-TO-DC CONVERTER
(IF INSTALLED)

Label Location:
(DC) (INV)
Per Code:
NEC 690.53

WARNING

INVERTER OUTPUT
CONNECTION
DO NOT RELOCATE
THIS OVERCURRENT
DEVICE

Label Location:
(POI)
Per Code:
NEC 705.12.B.2.3.b

SOLAR PV SYSTEM
EQUIPPED WITH RAPID
SHUTDOWN

TURN RAPID
SHUTDOWN SWITCH
TO THE "OFF"
POSITION TO SHUT
DOWN CONDUCTORS
OUTSIDE THE ARRAY.
CONDUCTORS WITHIN
THE ARRAY REMAIN
ENERGIZED IN SUNLIGHT

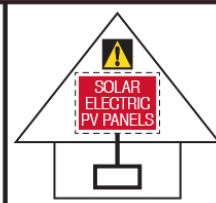

Label Location:
ABB/Delta Solivia Inverter
Per Code:
690.56(C)(1)(b)

WARNING

ELECTRIC SHOCK HAZARD
IF A GROUND FAULT IS INDICATED
NORMALLY GROUNDED
CONDUCTORS MAY BE
UNGROUNDDED AND ENERGIZED

Label Location:
(DC) (INV)
Per Code:
690.41.B

PHOTOVOLTAIC SYSTEM
EQUIPPED WITH RAPID
SHUTDOWN

Label Location:
(INV)
Per Code:
NEC 690.56.C.3

SOLAR PV SYSTEM
EQUIPPED WITH RAPID
SHUTDOWN

TURN RAPID
SHUTDOWN
SWITCH TO THE
"OFF" POSITION TO
SHUT DOWN PV
SYSTEM AND REDUCE
SHOCK HAZARD
IN THE ARRAY.

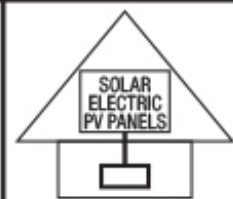

Label Location:
SolarEdge and,Delta M-Series and,Telsa Inverter
Per Code:
690.56(C)(1)(a)

WARNING

ELECTRICAL SHOCK HAZARD
DO NOT TOUCH TERMINALS
TERMINALS ON BOTH LINE AND
LOAD SIDES MAY BE ENERGIZED
IN THE OPEN POSITION
DC VOLTAGE IS
ALWAYS PRESENT WHEN
SOLAR MODULES ARE
EXPOSED TO SUNLIGHT

Label Location:
(DC) (CB)
Per Code:
CEC 690.13.B

CAUTION

PHOTOVOLTAIC SYSTEM
CIRCUIT IS BACKFED

Label Location:
(D) (POI)
Per Code:
NEC 690.64.B.4

CAUTION

DUAL POWER SOURCE
SECOND SOURCE IS
PHOTOVOLTAIC SYSTEM

Label Location:
(POI)
Per Code:
NEC 705.12.B.3

PHOTOVOLTAIC AC
DISCONNECT

Label Location:
(AC) (POI)
Per Code:
NEC 690.13.B

PHOTOVOLTAIC POINT OF
INTERCONNECTION
WARNING: ELECTRIC SHOCK
HAZARD. DO NOT TOUCH
TERMINALS. TERMINALS ON
BOTH THE LINE AND LOAD SIDE
MAY BE ENERGIZED IN THE OPEN
POSITION. FOR SERVICE
DE-ENERGIZE BOTH SOURCE
AND MAIN BREAKER.
PV POWER SOURCE

Label Location:
(POI)
Per Code:
CEC 690.13.B

MAXIMUM AC
OPERATING CURRENT A
MAXIMUM AC
OPERATING VOLTAGE V

Label Location:
(AC) (POI)
Per Code:
NEC 690.54

MAXIMUM AC
OPERATING CURRENT A
MAXIMUM AC
OPERATING VOLTAGE V

(AC): AC Disconnect
(C): Conduit
(CB): Combiner Box
(D): Distribution Panel
(DC): DC Disconnect
(IC): Interior Run Conduit
(INV): Inverter With Integrated DC Disconnect
(LC): Load Center
(M): Utility Meter
(POI): Point of Interconnection

BACKUP LOAD CENTER

Label Location:
(BLC)
Per Code:
NEC 408.4

CAUTION
TRI POWER SOURCE
SECOND SOURCE IS PHOTOVOLTAIC SYSTEM
THIRD SOURCE IS ENERGY STORAGE SYSTEM

Label Location:
(MSP)
Per Code:
NEC 705.12(B)(3)

CAUTION
DO NOT ADD NEW LOADS

Label Location:
(BLC)
Per Code:
NEC 220

WARNING
THIS EQUIPMENT FED BY
MULTIPLE SOURCES. TOTAL
RATING OF ALL OVER CURRENT
DEVICES, EXCLUDING MAIN
SUPPLY OVERCURRENT DEVICE,
SHALL NOT EXCEED AMPACITY
OF BUSBAR.

Label Location:
(MSP)
Per Code:
NEC 705.12.B.2.3.c

CAUTION
THIS PANEL HAS SPLICED FEED-
THROUGH CONDUCTORS.
LOCATION OF DISCONNECT AT ENERGY
STORAGE BACKUP LOAD PANEL

Label Location:
(MSP)
Per Code:
NEC 312.8.A(3)

NOMINAL ESS VOLTAGE: 120/240V
**MAX AVAILABLE SHORT-
CIRCUIT FROM ESS: 32A**
**ARC FAULT CLEARING
TIME FROM ESS: 67ms**
**DATE OF
CALCULATION:**

Label Location:
(MSP)
Per Code:
Per 706.7(D) label to be marked in field

CAUTION
DUAL POWER SOURCE
SECOND SOURCE IS
ENERGY STORAGE SYSTEM

Label Location:
(MSP)
Per Code:
NEC 705.12(B)(3)

**ENERGY STORAGE SYSTEM ON SITE
LOCATED WITHIN LINE OF SIGHT**

Label Location:
(MSP)
Per Code:

**ENERGY STORAGE SYSTEM ON SITE
LOCATED ON ADJACENT WALL**

Label Location:
(MSP)
Per Code:

**ENERGY STORAGE SYSTEM ON SITE
LOCATED ON OPPOSITE WALL**

Label Location:
(MSP)
Per Code:

**ENERGY STORAGE SYSTEM ON SITE
LOCATED INSIDE**

Label Location:
(MSP)
Per Code:

(AC): AC Disconnect
(BLC): Backup Load Center
(MSP): Main Service Panel

Label Set

MCI WIRING DETAIL

GENERAL NOTES

- DRAWING OF STANDARD MCI WIRING DETAIL FOR ANY GIVEN STRING LENGTH
- IF INITIATED, RAPID SHUTDOWN OCCURS WITHIN 30 SECONDS OF ACTIVATION AND LIMITS VOLTAGE ON THE ROOF TO NO GREATER THAN 165V (690.12.B.2.1)
- MID CIRCUIT INTERRUPTER (MCI) IS A UL 1741 PVRSE CERTIFIED RAPID SHUTDOWN DEVICE (RSD)

RETROFIT PV MODULES

- MCIS ARE LOCATED AT ROOF LEVEL, JUST UNDER THE PV MODULES IN ACCORDANCE WITH 690.12 REQUIREMENTS
- THE QUANTITY OF MCIS PER STRING IS DETERMINED BY STRING LENGTH
 - NUMBER OF MODULES BETWEEN MCI UNITS = 0-3
 - MAXIMUM NUMBER OF MODULES PER MCI UNIT = 3
 - MINIMUM NUMBER MCI UNITS = MODULE COUNT/3

*Exception: Tesla (Longi) modules installed in locations where the max Voc for 3 modules at low design temperature exceeds 165V shall be limited to 2 modules between MCIs.

PLEASE REFER TO MCI CUTSHEET AND PVRSA INSERT FOR MORE INFORMATION

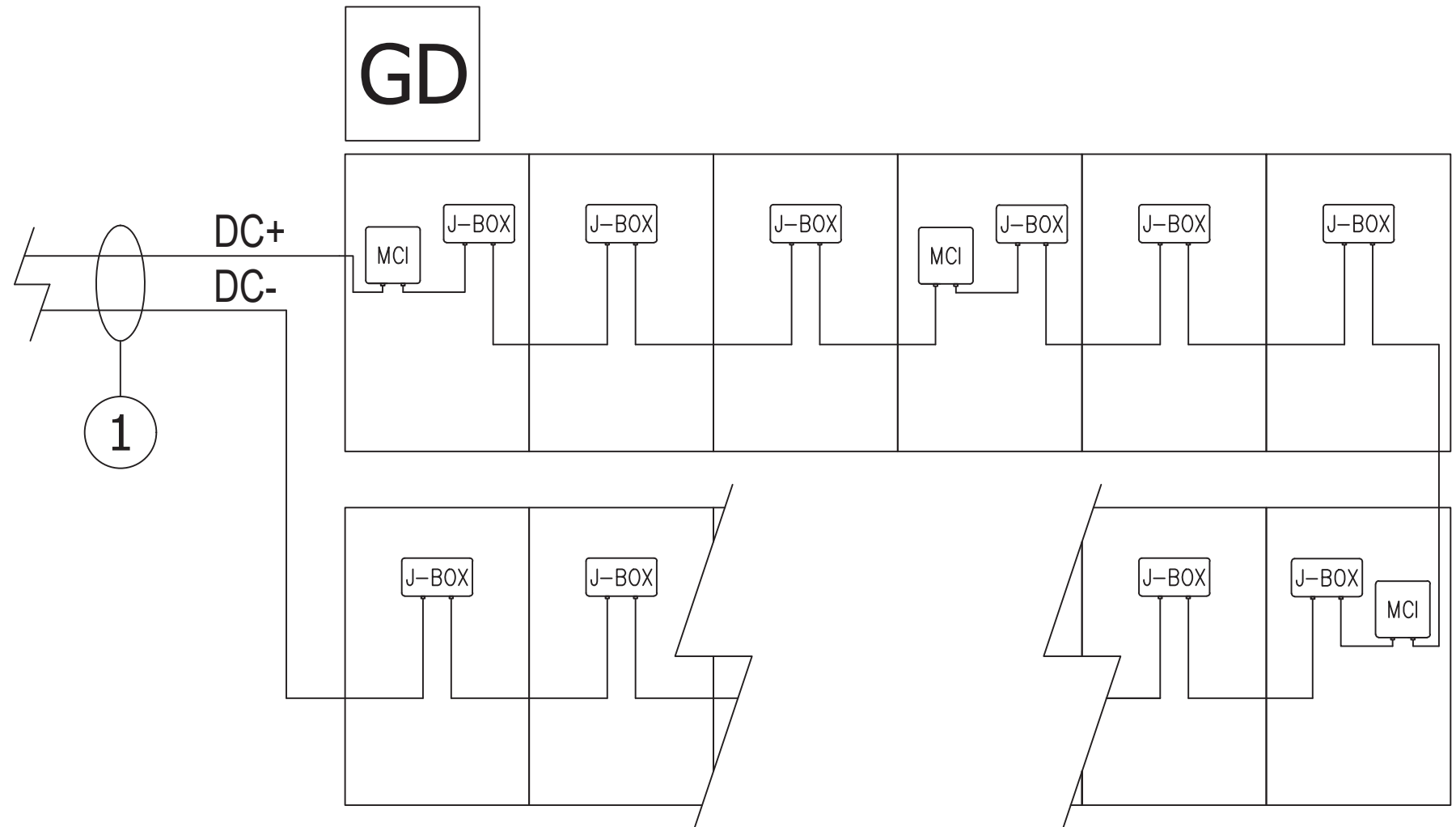

① (2)AWG, PV Wire, 600V, Black

DC

MCI WIRING DETAIL

GENERAL NOTES

- DRAWING OF STANDARD MCI WIRING DETAIL FOR ANY GIVEN STRING LENGTH
- IF INITIATED, RAPID SHUTDOWN OCCURS WITHIN 30 SECONDS OF ACTIVATION AND LIMITS VOLTAGE ON THE ROOF TO NO GREATER THAN 165V (690.12.B.2.1)
- MID CIRCUIT INTERRUPTER (MCI) IS A UL 1741 PVRSE CERTIFIED RAPID SHUTDOWN DEVICE (RSD)

SOLAR ROOF TILES

- MCIS ARE LOCATED AT DECK LEVEL, JUST UNDER THE TILES IN ACCORDANCE WITH 690.12 REQUIREMENTS
- THE QUANTITY OF MCIS PER STRING IS DETERMINED BY STRING LENGTH
 - NUMBER OF TILES BETWEEN MCI UNITS = 0-10
 - MAXIMUM NUMBER OF TILES PER MCI UNIT = 10
 - MINIMUM NUMBER MCI UNITS = TILE COUNT/10

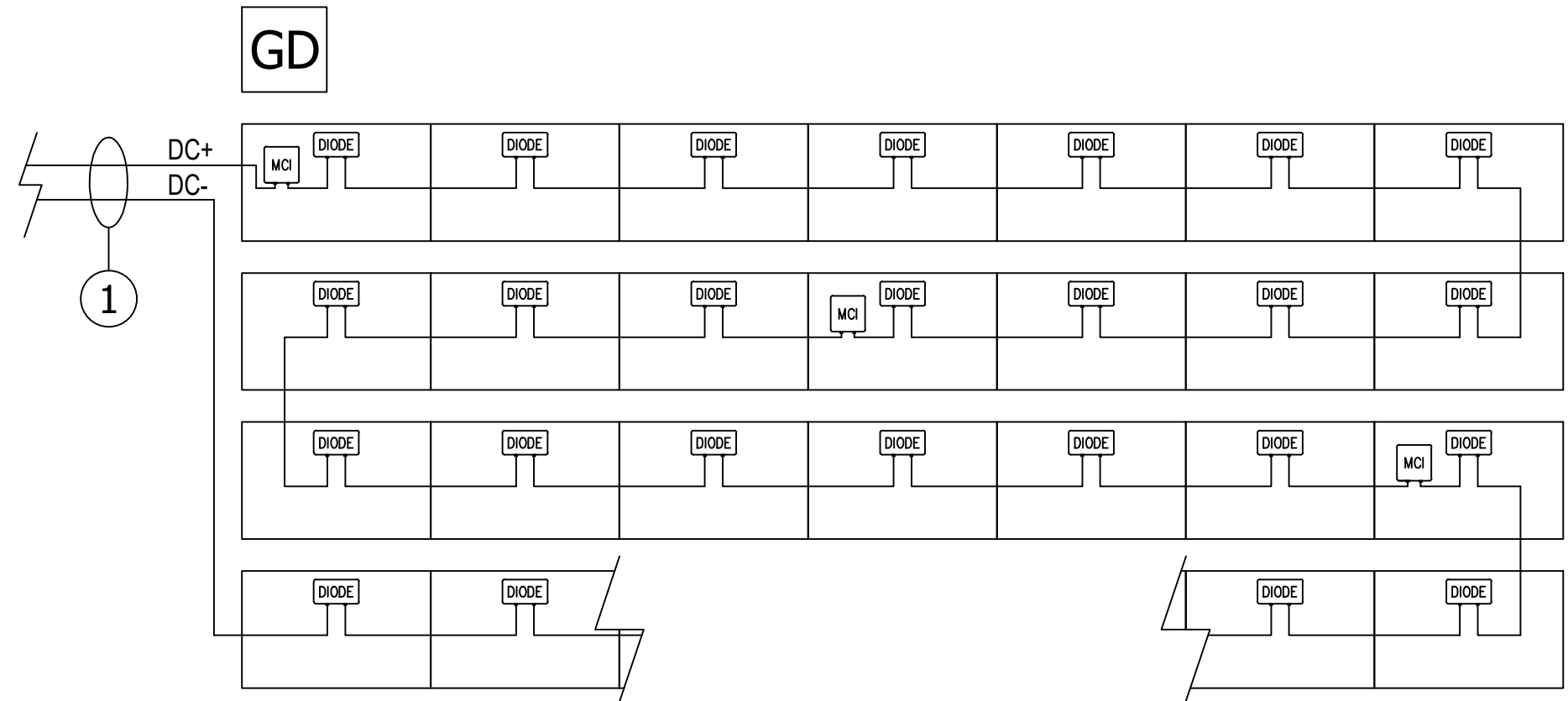

PLEASE REFER TO MCI CUTSHEET AND PVRSA INSERT FOR MORE INFORMATION

① (2)AWG, PV Wire, 600V, Black

DC



TESLA

SOLAR INVERTER

3.8 kW | 7.6 kW

Tesla Solar Inverter completes the Tesla home solar system, converting DC power from solar to AC power for home consumption. Tesla's renowned expertise in power electronics has been combined with robust safety features and a simple installation process to produce an outstanding solar inverter that is compatible with both Solar Roof and traditional solar panels. Once installed, homeowners use the Tesla mobile app to manage their solar system and monitor energy consumption, resulting in a truly unique ecosystem experience.

KEY FEATURES

- Built on Powerwall 2 technology for exceptional efficiency and reliability
- Wi-Fi, Ethernet, and cellular connectivity with easy over-the-air updates
- Designed to integrate with Tesla Powerwall and Tesla App
- 3.8 kW and 7.6 kW models available

SOLAR INVERTER

Tesla Solar Inverter provides DC to AC conversion and integrates with the Tesla ecosystem, including Solar Panels, Solar Roof, Powerwall, and vehicle charging, to provide a seamless sustainable energy experience.

KEY FEATURES

- Integrated rapid shutdown, arc fault, and ground fault protection
- No neutral wire simplifies installation
- 2x the standard number of MPPTs for high production on complex roofs



ELECTRICAL SPECIFICATIONS

MODEL NUMBER	1534000-xx-y	1538000-xx-y
OUTPUT (AC)	3.8 kW	7.6 kW
Nominal Power	3,800 W	7,600 W
Maximum Apparent Power	3,328 VA at 208 V 3,840 VA at 240 V	6,656 VA at 208 V 7,680 VA at 240 V
Maximum Continuous Current	16 A	32 A
Breaker (Overcurrent Protection)	20 A	40 A
Nominal Power Factor	1 - 0.9 (leading / lagging)	
THD (at Nominal Power)	<5%	
INPUT (DC)		
MPPT	2	4
Input Connectors per MPPT	1-2	1-2-1-2
Maximum Input Voltage	600 VDC	
DC Input Voltage Range	60 - 550 VDC	
DC MPPT Voltage Range	60 - 480 VDC ¹	
Maximum Current per MPPT (I _{mp})	13 A ²	
Maximum Short Circuit Current per MPPT (I _{sc})	17 A ²	

PERFORMANCE SPECIFICATIONS

Peak Efficiency	98% at 208 V 98.1% at 240 V	98.4% at 208 V 98.6% at 240 V
CEC Efficiency	97.5% at 208 V 97.5% at 240 V	97.5% at 208 V 98.0% at 240 V
Allowable DC/AC Ratio	1.7	
Customer Interface	Tesla Mobile App	
Internet Connectivity	Wi-Fi (2.4 GHz, 802.11 b/g/n), Ethernet, Cellular (LTE/4G) ³	
AC Remote Metering Support	Wi-Fi (2.4 GHz, 802.11 b/g/n), RS-485	
Protections	Integrated arc fault circuit interrupter (AFCI), Rapid Shutdown	
Supported Grid Types	60 Hz, 240 V Split Phase 60 Hz, 208 V Wye	

¹ Maximum current.

² Where the DC input current exceeds an MPPT rating, jumpers can be used to allow a single MPPT to intake additional DC current up to 26 A I_{mp} / 34 A I_{sc}.

³ Cellular connectivity subject to network operator service coverage and signal strength.

MECHANICAL SPECIFICATIONS

Dimensions	660 mm x 411 mm x 158 mm (26 in x 16 in x 6 in)
Weight	52 lb ⁴
Mounting options	Wall mount (bracket)

⁴ Door and bracket can be removed for a mounting weight of 37 lb.

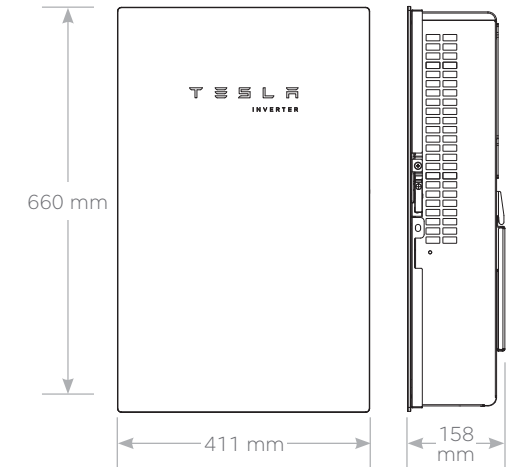

ENVIRONMENTAL SPECIFICATIONS

Operating Temperature	-30°C to 45°C (-22°F to 113°F) ⁵
Operating Humidity (RH)	Up to 100%, condensing
Storage Temperature	-30°C to 70°C (-22°F to 158°F)
Maximum Elevation	3000 m (9843 ft)
Environment	Indoor and outdoor rated
Enclosure Rating	Type 3R
Ingress Rating	IP55 (Wiring compartment)
Pollution Rating	PD2 for power electronics and terminal wiring compartment, PD3 for all other components
Operating Noise @ 1 m	< 40 db(A) nominal, < 50 db(A) maximum

⁵ For the 7.6 kW Solar Inverter, performance may be de-rated to 6.2 kW at 240 V or 5.37 kW at 208 V when operating at temperatures greater than 45°C.

COMPLIANCE INFORMATION

Grid Certifications	UL 1741, UL 1741 SA, IEEE 1547, IEEE 1547.1
Safety Certifications	UL 1741 PVRSS, UL 1699B, UL 1998 (US), UL 3741
Emissions	EN 61000-6-3 (Residential), FCC 47CFR15.109 (a)

SOLAR SHUTDOWN DEVICE

The Tesla Solar Shutdown Device is a Mid-Circuit Interrupter (MCI) and is part of the PV system rapid shutdown (RSD) function in accordance with Article 690 of the applicable NEC. When paired with the Tesla Solar Inverter, solar array shutdown is initiated by any loss of AC power.

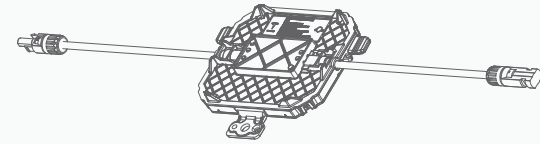

ELECTRICAL SPECIFICATIONS

Model Number	MCI-1
Nominal Input DC Current Rating (I_{MP})	12 A
Maximum Input Short Circuit Current (I_{SC})	15 A
Maximum System Voltage	600 V DC

RSD MODULE PERFORMANCE

Maximum Number of Devices per String	5
Control	Power Line Excitation
Passive State	Normally open
Maximum Power Consumption	7 W
Warranty	25 years

COMPLIANCE INFORMATION

Certifications	UL 1741 PVRSE, UL 3741, PVRSA (Photovoltaic Rapid Shutdown Array)
RSD Initiation Method	PV System AC Breaker or Switch
Compatible Equipment	See <i>Compatibility Table</i> below

ENVIRONMENTAL SPECIFICATIONS

Ambient Temperature	-40°C to 50°C (-40°F to 122°F)
Storage Temperature	-30°C to 70°C (-22°F to 158°F)
Enclosure Rating	NEMA 4 / IP65

MECHANICAL SPECIFICATIONS

Electrical Connections	MC4 Connector
Housing	Plastic
Dimensions	125 mm x 150 mm x 22 mm (5 in x 6 in x 1 in)
Weight	350 g (0.77 lb)
Mounting Options	ZEP Home Run Clip M4 Screw (#10) M8 Bolt (5/16") Nail / Wood screw

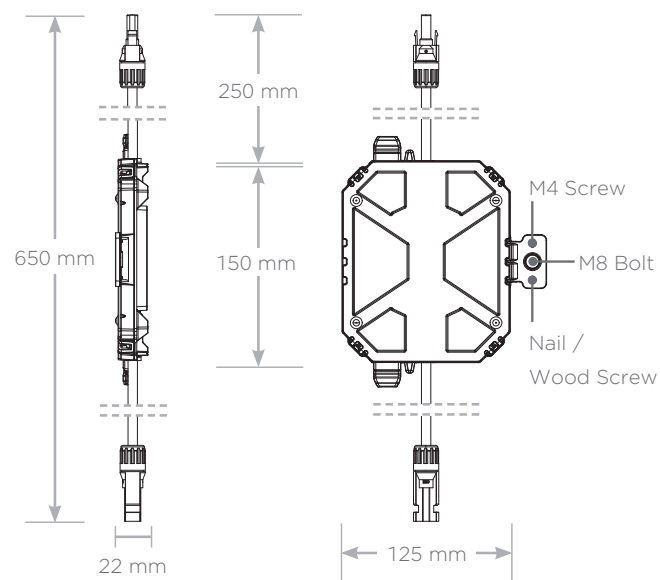

UL 3741 PV HAZARD CONTROL (AND PVRSA) COMPATIBILITY

Tesla Solar Roof and Tesla/Zep ZS Arrays using the following modules are certified to UL 3741 and UL 1741 PVRSA when installed with the Tesla Solar Inverter and Solar Shutdown Devices. See the Tesla Solar Inverter Installation Manual for detailed instructions and for guidance on installing Tesla Solar Inverter and Solar Shutdown Devices with other modules.

Brand	Model	Required Solar Shutdown Devices
Tesla	Solar Roof V3	1 Solar Shutdown Device per 10 modules
Tesla	Tesla TxxxS (where xxx = 405 to 450 W, increments of 5)	1 Solar Shutdown Device per 3 modules ¹
Tesla	Tesla TxxxH (where xxx = 395 to 415 W, increments of 5)	1 Solar Shutdown Device per 3 modules
Hanwha	Q.PEAK DUO BLK-G5	1 Solar Shutdown Device per 3 modules
Hanwha	Q.PEAK DUO BLK-G6+	1 Solar Shutdown Device per 3 modules

Exception: Tesla solar modules installed in locations where the max Voc for three modules at low design temperatures exceeds 165 V shall be limited to two modules between Solar Shutdown Devices.

Tesla Photovoltaic Module

T395H, T400H, and T405H

The Tesla module is one of the most powerful residential photovoltaic modules available and exceeds industry engineering and quality standards. Featuring our proprietary Zep Groove design, the all-black module mounts close to your roof for a minimalist aesthetic. Modules are certified to IEC / UL 61730 - 1, IEC / UL 61730 - 2 and IEC 61215.



Module Specifications

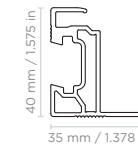

Electrical Characteristics

Power Class	T395H		T400H		T405H	
	STC	NMOT	STC	NMOT	STC	NMOT
Test Method	STC	NMOT	STC	NMOT	STC	NMOT
Max Power, P_{MAX} (W)	395	296.3	400	300.1	405	303.8
Open Circuit Voltage, V_{OC} (V)	45.27	42.69	45.30	42.72	45.34	42.76
Short Circuit Current, I_{SC} (A)	11.10	8.95	11.14	8.97	11.17	9.00
Max Power Voltage, V_{MP} (V)	36.88	35.03	37.13	35.25	37.39	35.46
Max Power Current, I_{MP} (A)	10.71	8.46	10.77	8.51	10.83	8.57
Module Efficiency (%)	≥ 20.1		≥ 20.4		≥ 20.6	
STC	1000 W/m ² , 25°C, AM1.5					
NOCT	800 W/m ² , 20°C, AM1.5, wind speed 1 m/s					

Mechanical Loading

Front Side Test Load	6120 Pa 128 lb/ft ²	Refer to module and system installation manuals for allowable design loads, foot spacings, and cantilever specifications.
Rear Side Test Load	6120 Pa 128 lb/ft ²	
Front Side Design Load	4080 Pa 85 lb/ft ²	
Rear Side Design Load	4080 Pa 85 lb/ft ²	
Hail Test	35 mm at 27.2 m/s	

Mechanical Parameters

Cell Orientation	132 (6 x 22)
Junction Box	IP68, 3 diodes
Cable	4 mm ² 12 AWG, 1325 mm 47.2 in. Length
Connector	Staubli MC4
Front Cover	0.13 in (3.2 mm) thermally pre-stressed glass
Frame	Black Anodized Aluminum Alloy
Weight	23.5 kg 51.8 lb
Dimension	1890 mm x 1046 mm x 40 mm 74.4 in x 41.2 in x 1.57 in

Operation Parameters

Operational Temperature	-40°C up to +85°C
Power Output Tolerance	-0 / +5 W
V_{OC} & I_{SC} Tolerance	+/- 5%
Max System Voltage	DC 1000 V (IEC/UL)
Max Series Fuse Rating	20 A
NOCT	45.7 +/- 3 °C
Safety Class	Class II
Fire Rating	UL 61730 Type 2

Linear Power Warranty

Materials and Processing	25 years
Extra Linear Power Output	25 years

At least 98% of nominal power during first year. Thereafter max. 0.5% degradation per year. At least 93.5% of nominal power up to 10 years. At least 86% of nominal power up to 25 years.

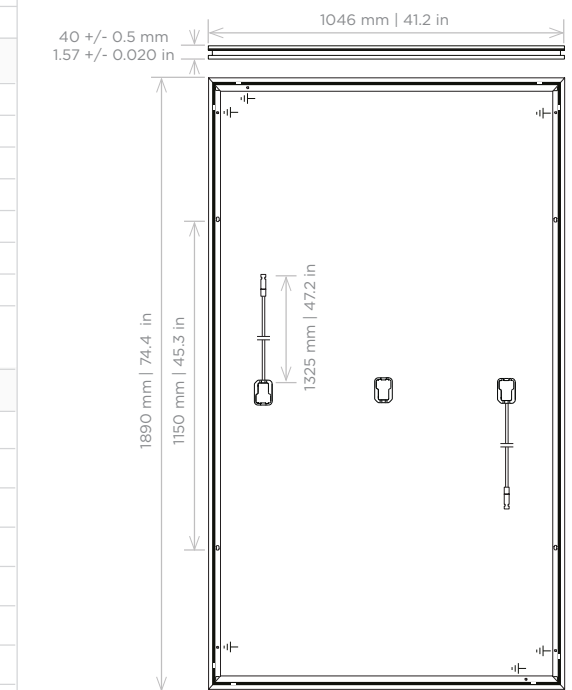

IV Curves

Current vs. Voltage

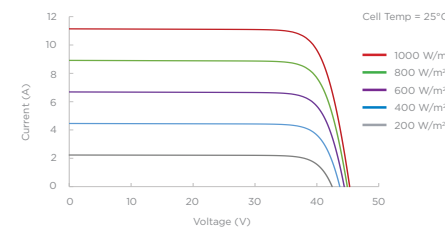

Power vs. Voltage

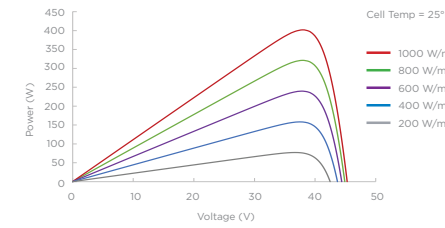

Current vs. Voltage

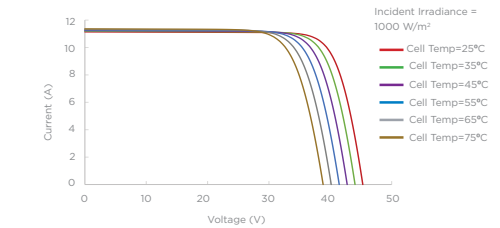

ROOFING SYSTEM SPECIFICATIONS



DESCRIPTION	PV mounting solution for composition shingle roofs.
	Works with all Zep Compatible Modules.
	Auto bonding UL-listed hardware creates structural and electrical bond.
SPECIFICATIONS	Designed for pitched roofs.
	Installs in portrait and landscape orientations.
	Engineered for spans up to 72" and cantilevers up to 24".
	ZS Comp has a UL 1703 Class "A" Fire Rating when installed using modules from any manufacturer certified as "Type 1" or "Type 2".
	Attachment method UL listed to UL 2582 for Wind Driven Rain.
	ZS Comp supports 50 psf (2400 Pa) front and up to 72 psf (3450 Pa) rear side design load rating for Portrait module orientation per UL 2703.
	ZS Comp supports 50 psf (2400 Pa) front side and up to 72 psf (3450 Pa) rear side design load rating for Landscape module orientation.
	Engineered for compliance with ASCE 7-05, 7-10, and 7-16 wind load requirements.
	Zep wire management products listed to UL 1565 for wire positioning devices.
ZS Comp grounding products are listed to UL 2703 and UL 467.	
ZS Comp bonding products are listed to UL 2703.	

MOUNTING BLOCK

Listed to UL 2703
Part #850-1633

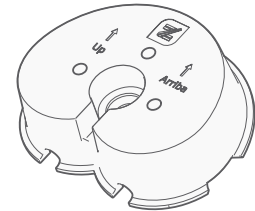

FLASHING INSERT

Listed to UL 2703 and UL 2582 for Wind Driven Rain
Part #850-1628

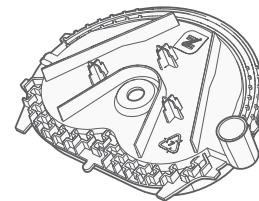

CAPTURED WASHER LAG

Part #850-1631-002 and #850-1631-004

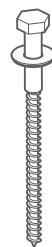

GROUND ZEP

Listed to UL 2703
Part #850-1511

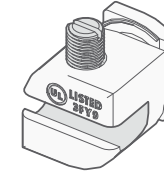

LEVELING FOOT

Listed to UL 2703
Part #850-1397

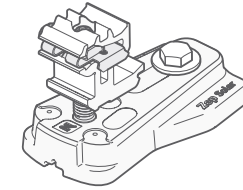

DC WIRE CLIP

Listed to UL 1565
Part #850-1509

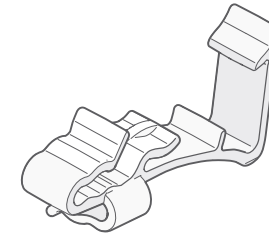

HOME RUN CLIP

Listed to UL 1565
Part #850-1510

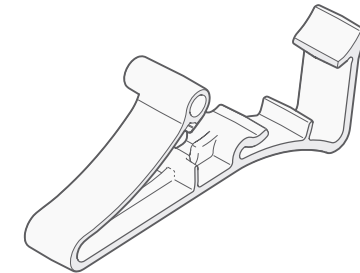

ARRAY SKIRT

Listed to UL 2703
Part #850-1608

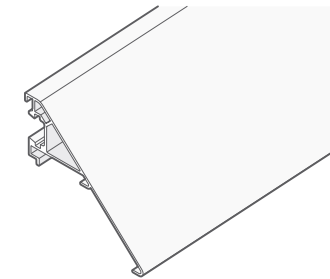

END CAP

Listed to UL 2703
Part #850-1586 (Left)
Part #850-1588 (Right)

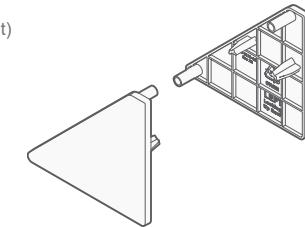

SKIRT GRIP

Listed to UL 2703
Part #850-1606

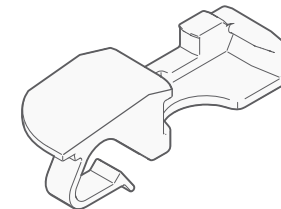

INTERLOCK

Listed to UL 2703
Part #850-1613

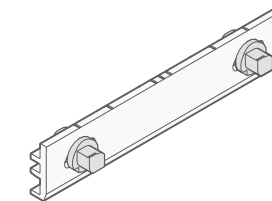

HYBRID INTERLOCK

Listed to UL 2703
Part #850-1281

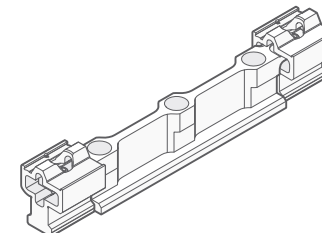

PV HAZARD CONTROL SYSTEM | ZS PVHCS

UL 3741 REPORT DATE 10-20-21 (APPLICABLE TO ZS COMP, ZS SPAN, ZS RAMP, AND ZS SEAM)

PV RAPID SHUTDOWN ARRAY, UL 1741 CATEGORY QIJR

WARNING: To reduce the risk of injury, read all instructions.

PV HAZARD CONTROL EQUIPMENT AND COMPONENTS

Function	Manufacturer	Model No.	Firmware Versions and Checksums	Certification Standard
PVRSE Mid Circuit Interrupter (MCI)	Tesla	MCI-1	N/A	UL 1741 PVRSE
Inverter or Powerwall+	Tesla	7.6 kW: 1538000 ¹ 3.8 kW: 1534000 ¹ 7.6 kW: 1850000 ¹	V4, CEA4F802 V4, FF7BE4E1 V4, CEA4F802	UL 1741, 1998 PVRSS/PVRSE
PV Module	Hanwha/ Q-CELLS Tesla	Q.PEAK DUO BLK-G5/SC310-320 Q.PEAK DUO BLK G6+/SC330-345 Tesla TxxxS (xxx = 405 to 450) Tesla TxxxH (xxx = 395 to 415)	N/A	UL 1703 UL 61730
PVHCS Initiator (PV Inverter)	Dedicated PV system AC circuit breaker or AC disconnect switch, labeled per NEC 690.12 requirements.			N/A
PVHCS Initiator (Powerwall+)	Emergency stop device (NISD)- Listed "Emergency Stop Button" or "Emergency Stop Device" or "Emergency Stop Unit".			UL 508 or UL 60947 Parts 1, 5-1 and 5-5

¹ Applies to variations of this part number with suffix of two numbers and one letter.

Note: PVHCS installation requirements may reduce the effective equipment and component ratings below the individual equipment and component PVRSE ratings in order to achieve PVHCS shock hazard reduction requirements.

PVHCS INSTALLATION REQUIREMENTS

Max System Voltage	600 Vdc
PVHCS Maximum Circuit Voltage (Array Internal Voltage After Actuation)	165 Vdc (cold weather open circuit)
Max Series-Connected Modules Between MCIs: *Exception: Tesla S-Series (TxxxS) modules installed in locations where the max VOC for 3 modules at low design temperature exceeds 165V shall be limited to 2 modules between MCIs.	3*

OTHER INSTALLATION INSTRUCTIONS

1. An MCI must be connected to one end of each series string or mounting plane sub-array string.
2. Verification that MCIs are installed with 3 or fewer modules between MCIs shall be documented for inspection, by voltage measurement logs and/or as-built string layout diagrams.
3. For PV Inverter: The PVHCS initiator (AC breaker or switch) shall be sized and installed in accordance with NEC requirements. The specific part shall be identified on the as-built system drawings.
4. For Powerwall+: The PVHCS emergency stop initiator shall have the following minimum ratings: Outdoor (Type 3R or higher), 12V, 1A, and shall be installed in accordance with NEC requirements. The specific part shall be identified on the as-built system drawings. Refer to the Powerwall+ installation manual for further details.



Certification Mark of UL on the installation instructions is the only method provided by UL to identify products manufactured under its Certification and Follow-Up Service. The Certification Mark for these products includes the UL symbol, the words "CERTIFIED" and "SAFETY," the geographic identifier(s), and a file number.

PV HAZARD CONTROL SYSTEM PVHCS | CERTIFICATION

UL 3741 REPORT DATE 8-12-21

PV RAPID SHUTDOWN ARRAY, UL 1741 CATEGORY QIJR, REPORT DATE: 2021-06-11 (REV 8-10-21)

WARNING: To reduce the risk of injury, read all instructions.

PV HAZARD CONTROL EQUIPMENT AND COMPONENTS

Function	Manufacturer	Model No.	Firmware Versions and Checksums	Certification Standard
PVRSE Mid Circuit Interrupter (MCI)	Tesla	MCI-1 1550379 ¹	N/A	UL 1741 PVRSE
Inverter or Powerwall+	Tesla	7.6 kW: 1538000 ¹ 3.8 kW: 1534000 ¹ 7.6 kW: 1850000 ¹	V4, CEA4F802 V4, FF7BE4E1 V4, CEA4F802	UL 1741, 1998 PVRSS/PVRSE
PV Module	Tesla	SR60T1, SR72T1 SR72T2	N/A	UL 61730
Diode Harness (Not applicable to SR72T2)	Tesla	SRDTH	N/A	UL 9703
PV Wire Jumper(s)	Tesla	SR-BJ2X, SR-BJ3X, SR-BJ4X, SR-BJMini	N/A	UL 9703
Pass-Through Box	Tesla	SRPTB-4	N/A	UL 1741
PVHCS Initiator : (PV Inverter)	Dedicated PV system AC circuit breaker or AC disconnect switch, labeled per NEC 690.12 requirements.			N/A
PVHCS Initiator : (Powerwall+)	Emergency stop device (NISD)- Listed "Emergency Stop Button" or "Emergency Stop Device" or "Emergency Stop Unit"			UL 508 or UL 60947 Parts 1, 5-1 and 5-5

¹ Applies to variations of this part number with suffix of two numbers and one letter.

Note: PVHCS installation requirements may reduce the effective equipment and component ratings below the individual equipment and component PVRSE ratings in order to achieve PVHCS shock hazard reduction requirements.

PVHCS INSTALLATION REQUIREMENTS

Max System Voltage	600 Vdc
PVHCS Maximum Circuit Voltage (Array Internal Voltage After Actuation)	165 Vdc (cold weather open circuit)
Max Series-Connected Panels between MCIs	10

OTHER INSTALLATION INSTRUCTIONS

1. An MCI must be connected to one end of each series string or mounting plane sub-array string.
2. Verification that MCIs are installed with 10 or fewer modules between MCIs shall be documented for inspection, by voltage measurement logs and/or as-built string layout diagrams.
3. For PV Inverter: The PVHCS initiator (AC breaker or switch) shall be sized and installed in accordance with NEC requirements. The specific part shall be identified on the as-built system drawings.
4. For Powerwall+: The PVHCS emergency stop initiator shall have the following minimum ratings: Outdoor (Type 3R or higher), 12V, 1A, and shall be installed in accordance with NEC requirements. The specific part shall be identified on the as-built system drawings. Refer to the Powerwall+ installation manual for further details.



Certification Mark of UL on the installation instructions is the only method provided by UL to identify products manufactured under its Certification and Follow-Up Service. The Certification Mark for these products includes the UL symbol, the words "CERTIFIED" and "SAFETY," the geographic identifier(s), and a file number.