

January 28, 2024

Islington Place Condo Association

Location: 369-373 Islington Street, Portsmouth, NH 03801

Scope of Work:

- Remove current shingles and replace with new Certainteed Landmark Moire Black architectural shingles.
- Replace white metal coil exterior trim where needed with similar metal wrap.
- Remove asbestos siding and replace with Alside Charter Oak Premium Vinyl Siding, Color: Riviera Dusk, 4 ½" clapboard matte
- Instal white vinyl corner trim, 6"
- Remove and install new Harvey Slimline white vinyl windows, one over one grid pattern, to the entire first floor(except the store front windows)
- The cap and corbelling detail shall be replicated on the shorter chimney.
- The chimneys shall be shortened to be at least 2.5 ft. above the ridge of the roof.
- Replace exterior deck boards on the side decks with Trex Transcend Pebble Gray decking and charcoal vinyl rails and balusters.



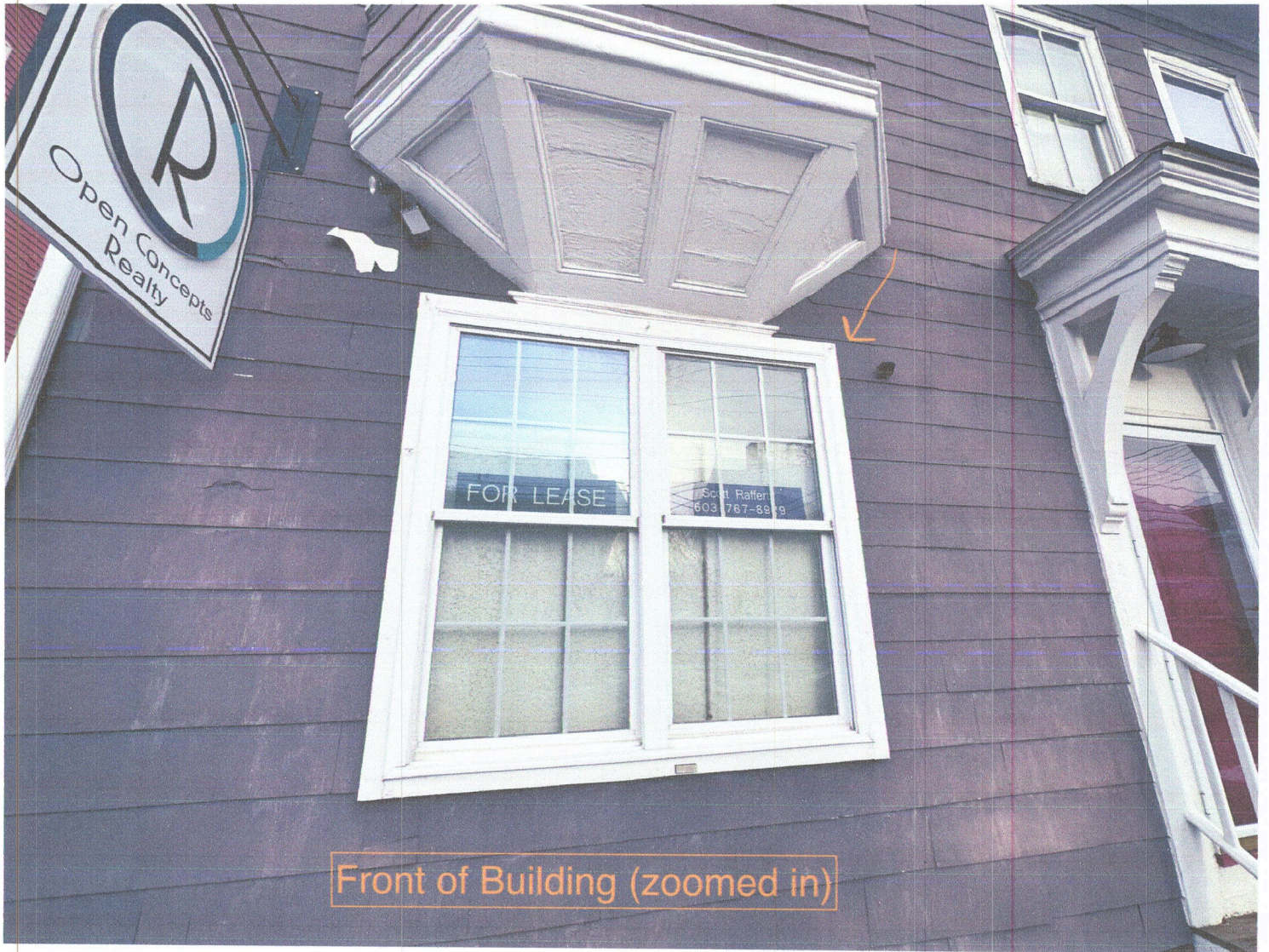

Front of Building (zoomed in)



Left Side of Building







Right Side of Building

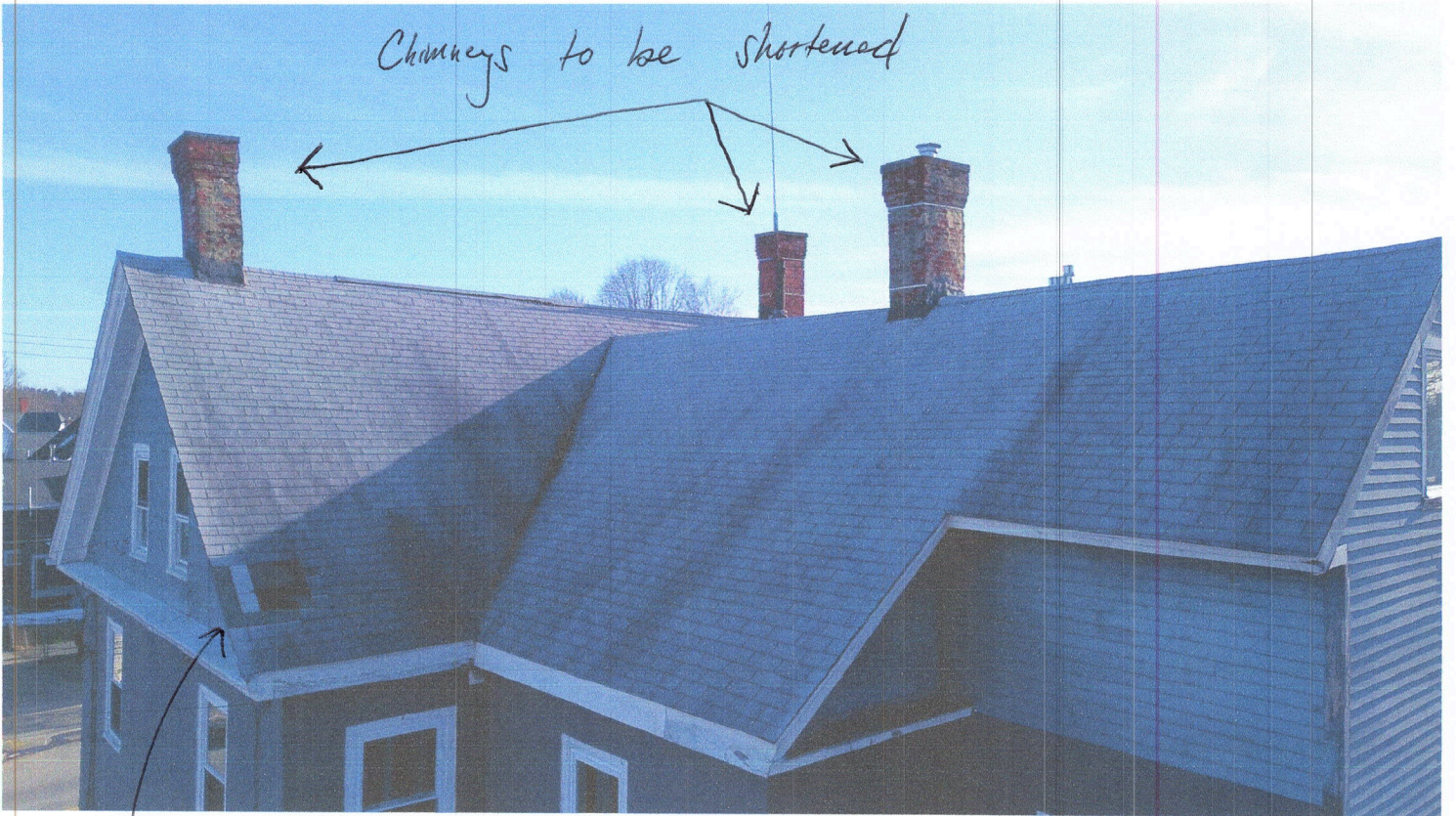

Missing Shingles



Siding falling off

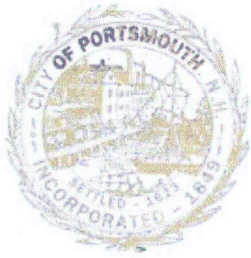

CITY OF PORTSMOUTH

Planning Department
1 Junkins Avenue
Portsmouth, New
Hampshire 03801

(603) 610-7216

HISTORIC DISTRICT COMMISSION

March 12, 2020

Islington Place Condominium Association
238 Parsons Road
Rye, NH 03801

RE: 369 Islington Street, Unit B

Dear Owner:

The Historic District Commission, at its regularly scheduled meeting of **Wednesday March 11, 2020**, considered your application for renovations to an existing structure (lower existing, non-functional chimneys) as per plans on file in the Planning Department. Said property is shown on Assessor Map 144, Lot 22 and lies within the Character District 4-L2 (CD4-L2) and Historic Districts. As a result of said consideration, the Commission voted to **grant** the Certificate of Approval with the following stipulations:

1. The cap and corbelling detail shall be replicated on the shorter chimney.
2. The chimneys shall be at least 2.5 ft. above the ridge of the roof.

Findings of Fact

A. Purpose and Intent

The proposed application meets the following objective(s) of the Historic District (as provided in Section 10.631.20 of the Zoning Ordinance):

-Preserve the integrity of the district.

B. Review Criteria

The proposed application also meets the following review criteria of the Historic District (as provided in Section 10.635.70 of the Zoning Ordinance):

-Consistent with special and defining character of surrounding properties.

The Commission's decision may be appealed up to thirty (30) days after the vote. Any action taken by the applicant pursuant to the Commission's decision during this appeal period shall be at the applicant's risk. Please contact the Planning Department for more details about the appeals process.

Approvals may also be required from other City Committees or Boards. Once all required approvals have been received, applicant is responsible for applying for and securing a building permit from the Inspection Department prior to starting any project work.

This approval shall expire unless a building permit is issued within a period of one (1) year from the date granted by the Historic District Commission unless an extension is granted by the Commission in accordance with Section 10.636.70 of the Zoning Ordinance.

Please note that any changes or modifications to this application require review and approval from the Commission prior to implementation and additional fees may apply.

The minutes and audio recording of this meeting are available by contacting the Planning Department.

Very truly yours,

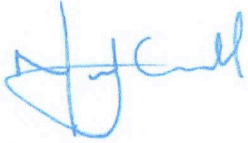

Nicholas J. Cracknell, AICP, Principal Planner
for Vincent Lombardi, Chairman of the Historic District Commission

cc: Robert Marsilia, Chief Building Inspector
Rosann Maurice-Lentz, City Assessor

Stephen Iandoli, Applicant

The Trusted Classic

LANDMARK®

Owning a Landmark roof brings peace of mind. Landmark's dual-layered construction and exceptional durability provide long-lasting protection for your home.

- Dual-layered for extra dimensionality and protection from the elements
- Offers the widest array of colors in the industry
- Independently certified as meeting the highest quality standards for roofing



Georgetown Gray



Scan code for
more information

See next page for full color palette.



SLIMLINE
Double Hung

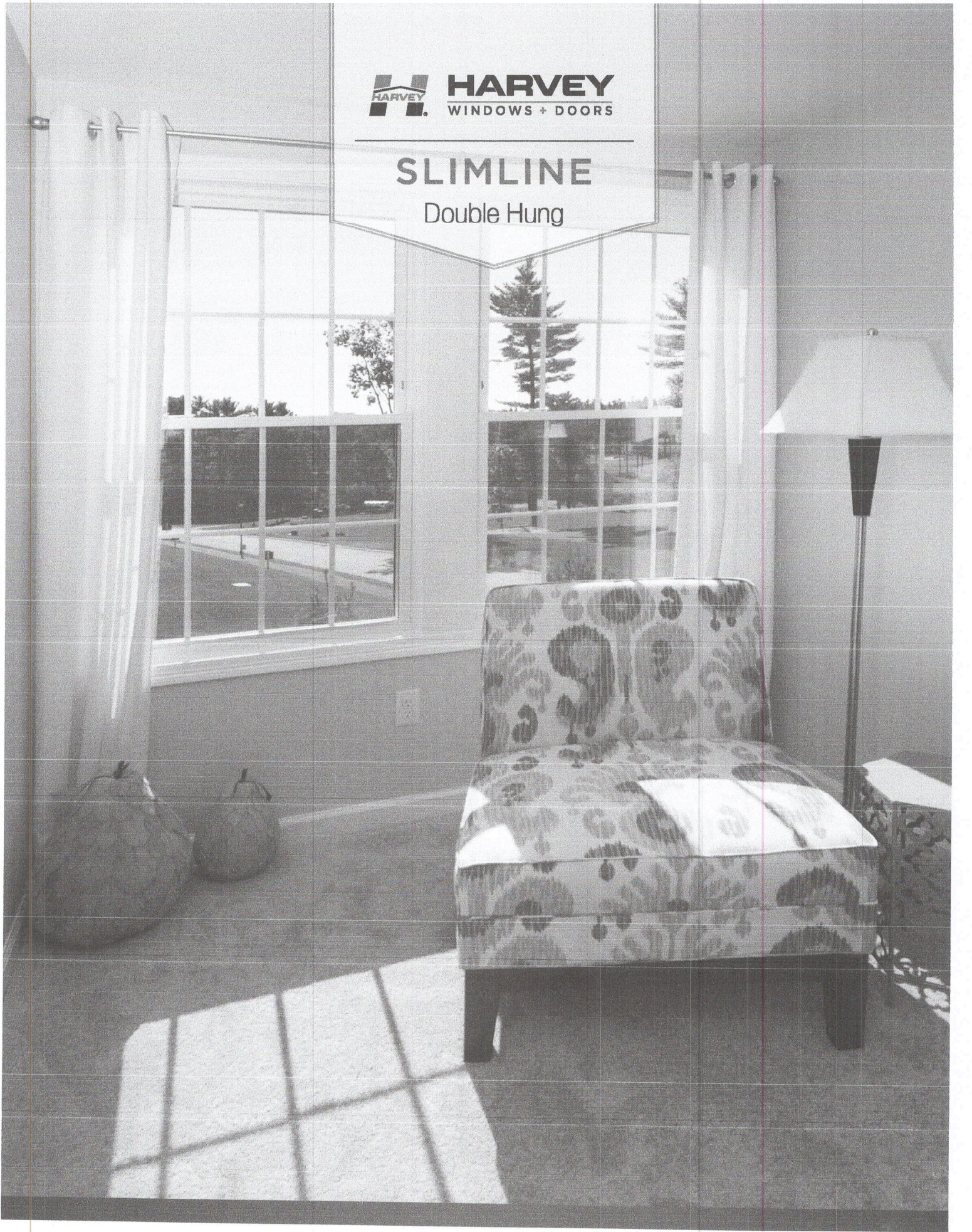

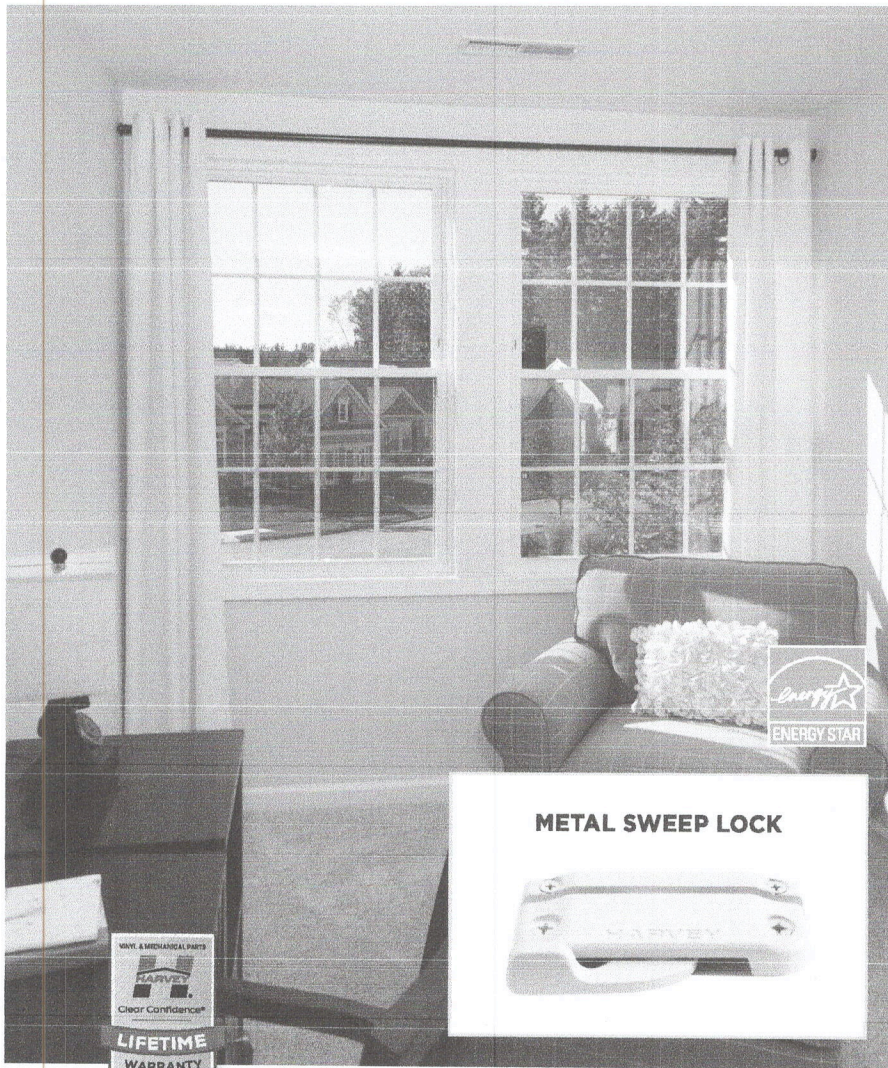

METAL SWEEP LOCK



The Harvey Slimline vinyl double hung window lives up to its name boasting a slimmer, fully-welded sash profile and frame that maximizes your view. Sweep lock is low profile, and made of durable metal.

Options



White Vinyl (Standard)

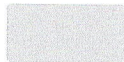

Almond Vinyl

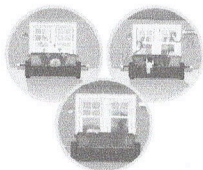

SunGain PLUS HSHG
ThermaLock RS
SunShield PLUS/SunShield

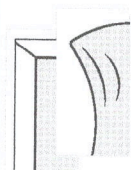

FlexScreen
Aluminum



Fiberglass Mesh
VIEWS Mesh

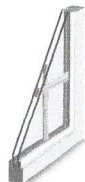

GBG

MORE OPTIONS & FEATURES

Grids come in 5/8" size

Custom grid configurations plus oriel & cottage sash options

Full and half size screens

Double locks are standard on widths 30" and over

Both sashes tilt in for cleaning; ventilation limit latches keep bottom or top sash partially opened

Available in single hung

*1 over 1 grid pattern
w/ historic sill*



An Exceptional Way to Create Lasting Beauty

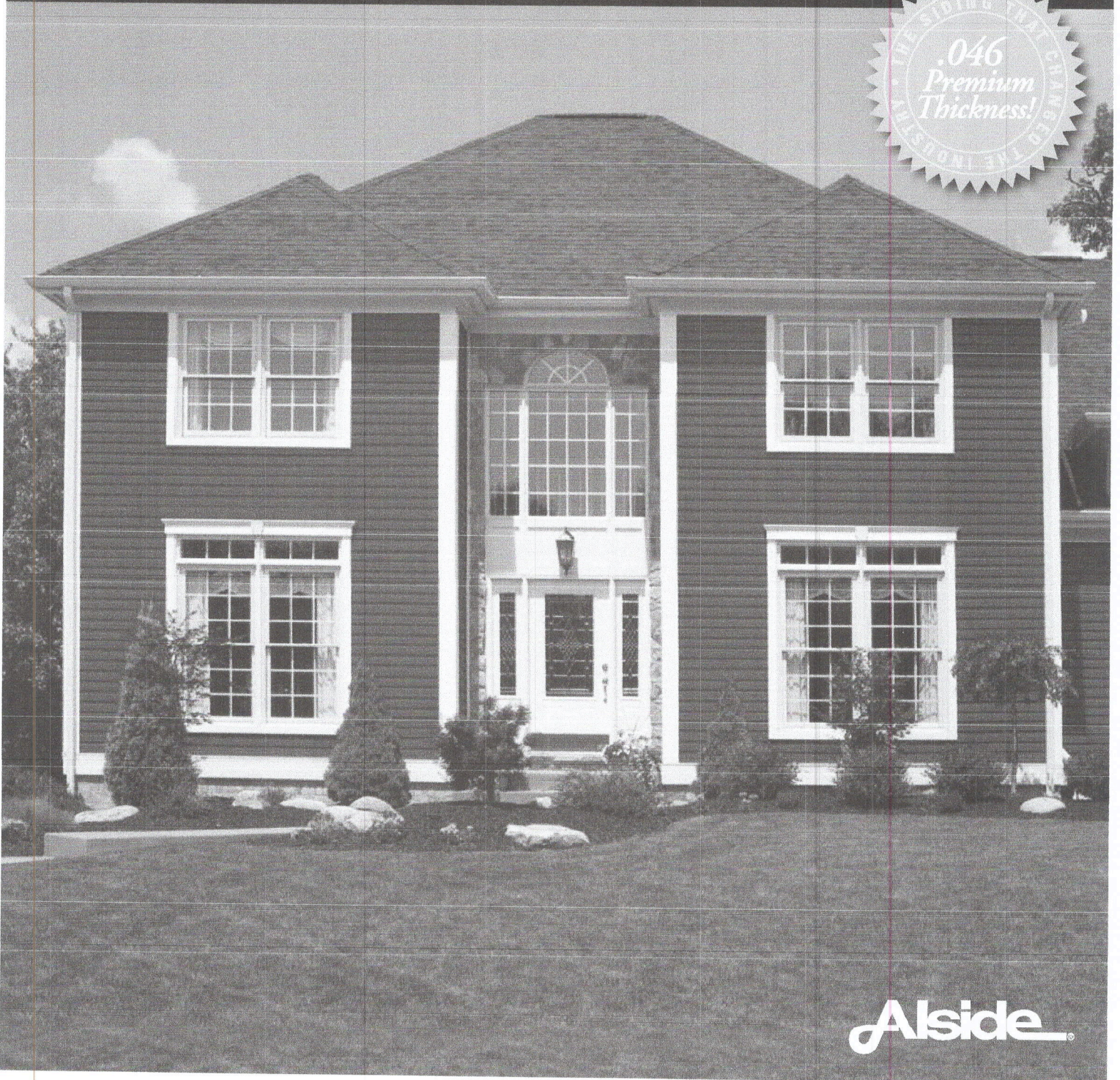
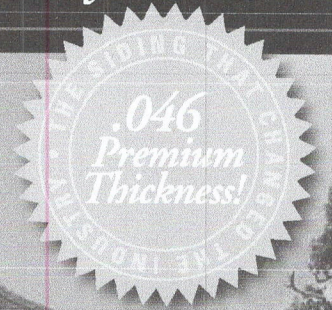

Alside[®]

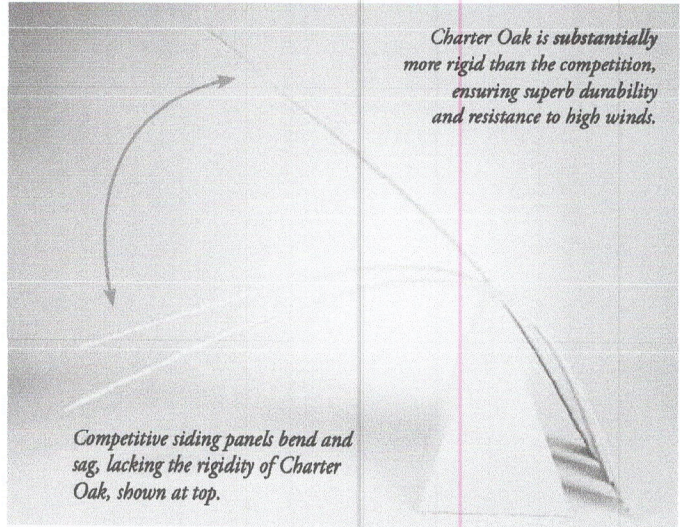

Charter Oak is substantially more rigid than the competition, ensuring superb durability and resistance to high winds.

Competitive siding panels bend and sag, lacking the rigidity of Charter Oak, shown at top.

BEAUTIFULLY RESILIENT AGAINST SAGGING

Charter Oak is substantially more rigid than the competition. Rigidity, as with Charter Oak panels, is important for long-lasting performance and resistance to bending and sagging. Your home will have a beautifully uniform finish that stands the test of time.

A MORE SUSTAINABLE CHOICE

The home that protects you can also help protect the environment. As a durable product with a long service life, vinyl soffit panels such as those manufactured by Alside have been shown in a cradle-to-grave Life Cycle Assessment study commissioned by the Vinyl Siding Institute to have a smaller environmental footprint relative to competing materials.** And because it never needs to be painted, vinyl soffit also helps prevent paint, stain and other maintenance-related products from being released to the environment.



DID YOU KNOW for nearly two decades vinyl siding has been a leading choice for exterior cladding on new single-family homes. This broad appeal stems not only from its beauty, durability, and easy upkeep, but also from the fact that vinyl siding adds value to homes.

CHARTER OAK'S TRIBEAM® SYSTEM

Designed for Superior Performance

INNOVATIVE TRIBEAM SYSTEM PROVIDES IMPRESSIVE PANEL RIGIDITY AND SUPERIOR WIND RESISTANCE

Charter Oak's lasting beauty isn't a result of just blending premium raw materials. Product engineers have created an exceptional design for Charter Oak that provides greater rigidity and resistance to high winds.

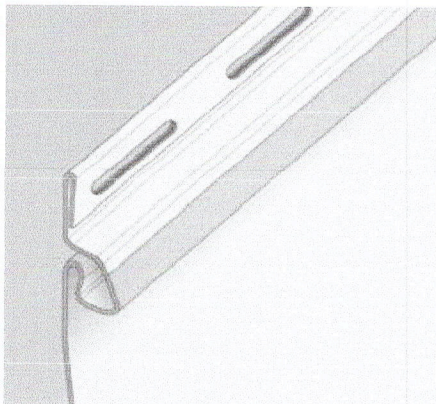

The unique TriBeam system fortifies Charter Oak's rigidity, helping to ensure straight course lines and even walls, on both new and existing homes. The result is a markedly superior installation with the built-in strength to ensure an enduring beautiful appearance.

The TriBeam illustration above shows another feature that's especially important if you live in an area where high winds are common. It's a rolled-edge nail hem that gives Charter Oak its increased strength to resist the force of intense winds. This high-performance panel has been tested to withstand negative windload resistance per ASTM D5206 and meets or exceeds the industry standard for windload performance.



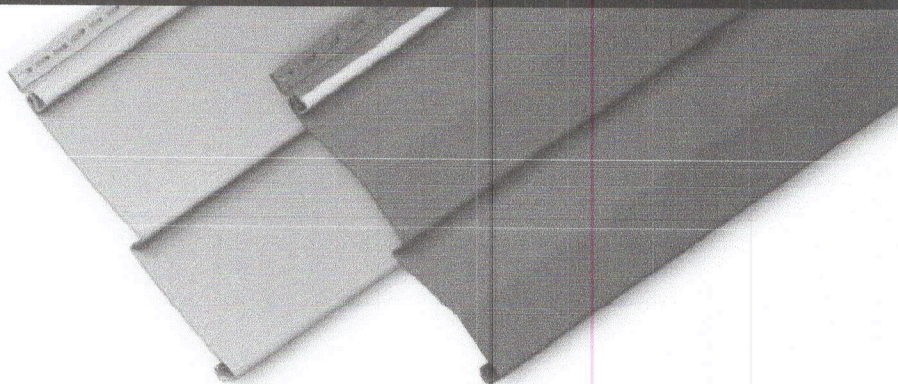

QUALITY YOU CAN COUNT ON

Made to be the best. And made to last. That's what you can count on when you choose Charter Oak Premium Vinyl Siding. You have the confidence that comes when working with a company recognized and respected for its manufacturing and quality control excellence. Plus you have the assurance that comes with Alside's lifetime limited warranty.*

Make your first choice the best choice . . . Charter Oak Premium Vinyl Siding.

MADE WITH PREMIUM RAW MATERIALS

Developing a tough, durable and beautiful vinyl siding such as Charter Oak requires the technical skills of a chemical process engineer and the visual sensibilities of an architect. That's because the premium vinyl used in Charter Oak is more than just a simple vinyl resin. It's a specially formulated compound, with each ingredient chosen to add specific benefits to the final product.

PureStrength vinyl resin gives Charter Oak its basic strength and weather resistance. It prevents moisture infiltration from rain and humidity, so panels won't rot, warp, shrink or swell. The result is low-cost, easy-care maintenance.

Ti-Shield titanium dioxide helps prevent ultraviolet degradation, so even hot summer sun won't damage Charter Oak's beautiful surface.

StayRight vinyl stabilizers also help prevent heat degradation, both during manufacturing and after installation.

TrueShield impact modifiers give Charter Oak exceptional impact resistance, helping to prevent denting and dinging from routine around-the-house activities.

DesignersChoice pigment concentrates are used to produce beautiful high-performance color for every Charter Oak panel. You'll never have to stain or paint again, because the color won't wash away.

Charter Oak. Technically, it's beautiful.

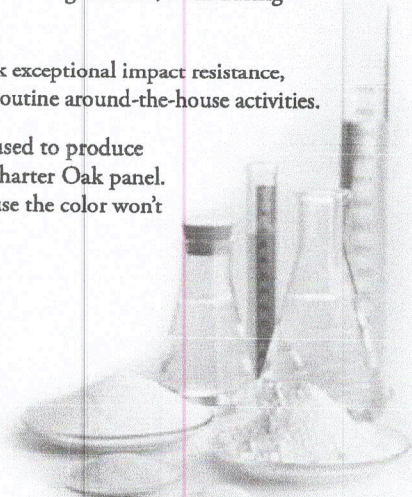

— CHARTER OAK PREMIUM VINYL SIDING —

CHARTER OAK® . . . GIVE YOUR HOME A BEAUTIFUL NEW LOOK

with one of the most advanced vinyl sidings you can buy. Outstanding beauty begins with exceptional product quality.



A PREMIER HOME EXTERIOR

Refined style, outstanding performance and a lifetime of protection – that's the power of Charter Oak Premium Vinyl Siding. Featuring a wide range of architectural colors in the timeless beauty of clapboard and handcrafted old-world charm of dutch lap, Charter Oak makes it easy to achieve custom elegance for your home.

If you like the idea of having more free time and less home maintenance, you will appreciate Charter Oak. It recreates the beauty of freshly painted wood siding, but without the worries of rotting, splitting or insect damage. An occasional rinse with a garden hose will remove most airborne dust and dirt to restore the like-new appearance.

— CHARTER OAK PREMIUM VINYL SIDING —

The ESSENCE of AMERICA'S ARCHITECTURAL HERITAGE . . . Made Convenient for Today's Easy-Care Lifestyle

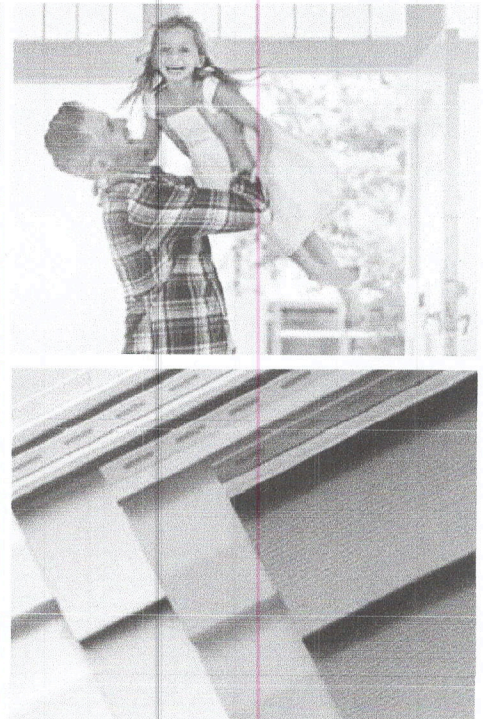

INDEPENDENTLY TESTED FOR QUALITY AND SAFETY

When you choose Charter Oak, you get more than Alside's assurance of quality. Under an independent program sponsored by the Vinyl Siding Institute (VSI), Charter Oak has received ASTM D3679 certification, the industry standard for quality.

PEACE OF MIND

Charter Oak Premium Vinyl Siding and Alside accessories are backed by lifetime limited warranties.* For complete warranty information, including limitations, please see a printed copy of the warranty.



HOME VISUALIZER

See the finished look before the work begins! Our Alside siding visualizer lets you create multiple exterior designs with just the click of a mouse. Simply select a house style – or submit a photo of your own home – and choose siding profiles, accents, soffit and trim, along with color options for doors, roofing, shutters and more. Visit www.alside.com/color-design to get started today.

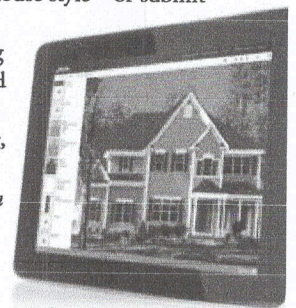

CERTIFICATION PROGRAM
Pertains to Charter Oak Vinyl Siding
Consult the VSI website at www.vinylsiding.org
for a current list of certified products.

Alside

Alside 3773 State Road Cuyahoga Falls, Ohio 44223
1-800-922-6009 www.alside.com



CUSTOM CRAFTED IN
AMERICA



©2023 Alside. Trademarks mentioned in this document are the property of Alside, its affiliates, or their respective owners. *For a copy of the written product warranty, please visit www.alside.com/support/content/uploads/2022/06/VSI-EPD-VinylSiding-2022.pdf (accessed 12/15/23). Colors may be slightly different from their appearance in this brochure. Make final color selections using actual product samples. Specifications subject to change without notice. Printed in USA 12/23 25M/OP 75-0137-01

ALL PRODUCTS ARE COLOR-COORDINATED WITH CHARTER OAK SIDING

When you're creating an exterior design, the delight is in choosing the details. Siding color defines the total mass of your home; trim and accent details focus on particulars, highlighting those special features and characteristics that set your home apart.

Alside offers a wide selection of trim and accent products made to complement the beauty and colors of Charter Oak siding.

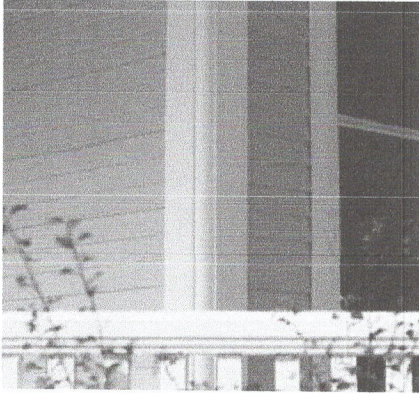

Trimworks® three-piece beaded corner post.

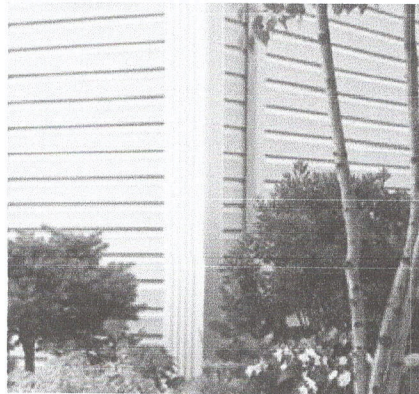

Trimworks 7" fluted corner post.



Trimworks traditional corner post.

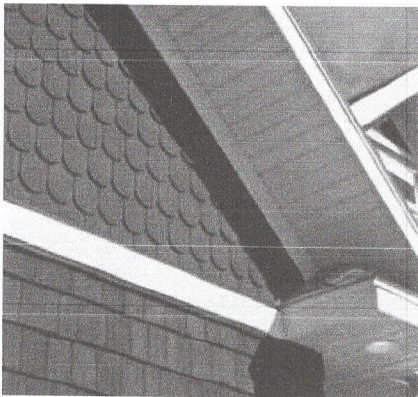

Alside Premium Scallops – Victorian-inspired half-round shingles.



Alside Premium Shakes – the classic look of deep-grained cedar shakes.



Board & Batten vertical siding accentuates gables and other areas.



Charter Oak clapboard with Trimworks 5" window trim.



Charter Oak dutch lap with Trimworks 3-1/2" window trim.

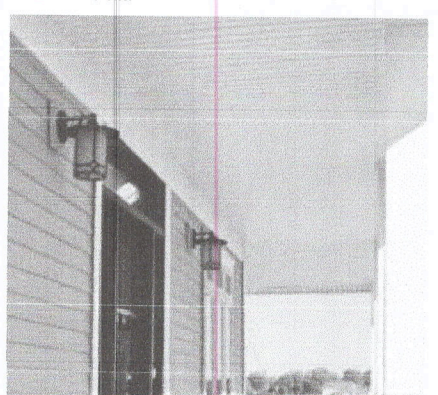

Charter Oak soffit easily spans long runs without sagging.

EXPRESS YOURSELF *with* ON-TREND COLORS

Richer Colors Tailored to Your Style

CHOOSING COLOR FOR YOUR HOME HAS NEVER BEEN EASIER

From Deep Espresso to Laguna Blue, the line-up of architectural colors doesn't shy away from bold and beautiful. Mix and match complementary shades for a look that is fresh and serene or combine more than one shade to bring richness and sophistication to your home.

STANDARD COLOR COLLECTION

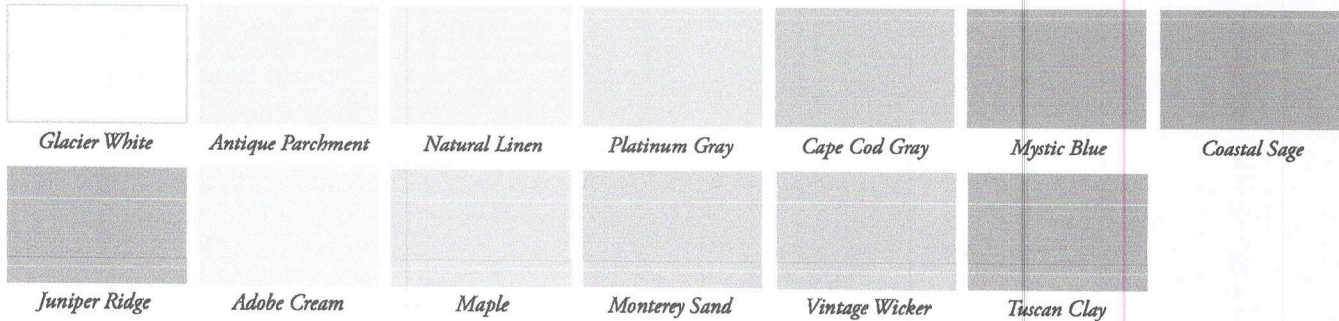

ARCHITECTURAL COLOR COLLECTION

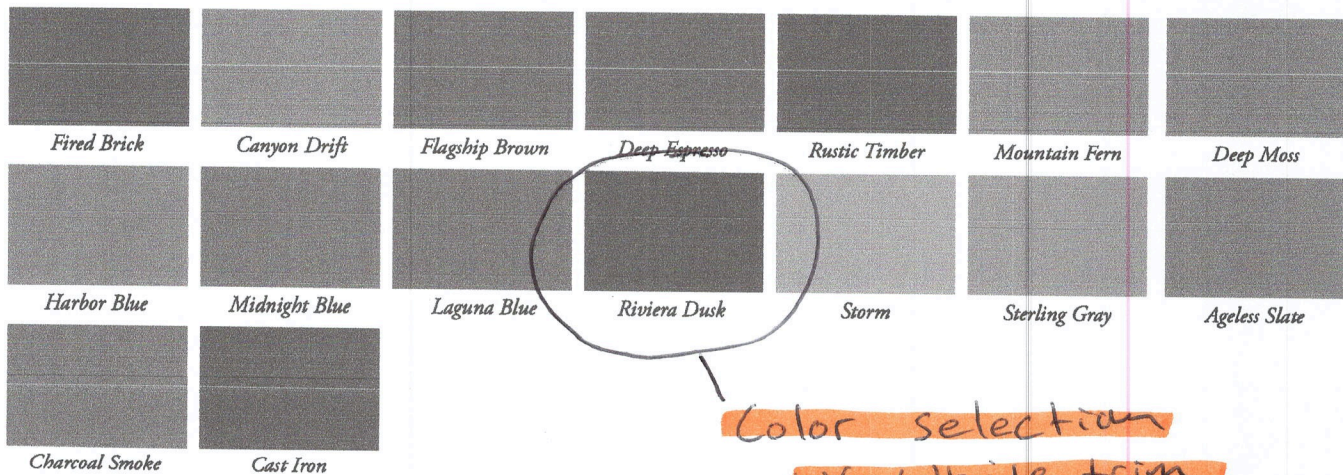

Note: Colors may be slightly different from their appearance in this brochure. Make final color selections using actual product samples. Color availability may vary by market. See your Alside Sales Representative for details.



Our darker siding colors are fortified with ChromaTrue® technology for superior color retention. This advanced copolymer compound provides long-term color stability and better performance on darker colors.

THE ART OF THE MIX

There's no need to settle for siding and trim that almost match. Alside's ColorConnect® Color Matching System offers smart solutions for every design approach. ColorConnect standards have been painstakingly applied to select Alside products to ensure you are making tasteful color choices with enduring aesthetic value and the custom look you desire.

Whether it's a rich color that draws your eye to an interesting architectural detail, or neutral hues applied to a historic home, the Alside ColorConnect Color Matching System helps you successfully match the color of your siding with other Alside exterior products and accessories.



SHOP DEALS ON EVERYTHING YOU NEED TO HOST THE BEST SUPER BOWL LVIII PARTY. SHOP NOW >

Search 

 Greenland Lowe's Open until 9 PM 

Delh
0384



Prices, Promotions, styles, and availability may vary. Our local stores do not honor online pricing. Prices and availability of products and service subject to change without notice. Errors will be corrected where discovered, and Lowe's reserves the right to revoke any stated offer and to correct any errors, inaccuracies or omissions including after an order has been submitted.

[Building Supplies / Decking / Deck Railing Systems](#)

Trex Enhance 6-ft x 2.75-in x 36-in Charcoal Black Composite Deck Rail Kit

Item #735744 | Model #BKRD0636HENKRT

[Shop Trex](#)  269

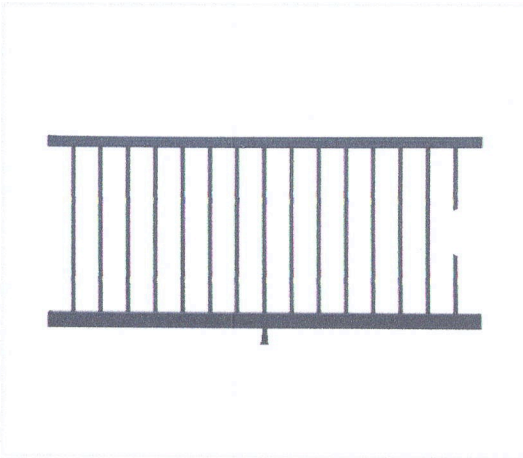

\$151.00



 **\$143.45** when you choose 5% savings on eligible purchases every day. [Learn How](#)

 **12 monthly installments of \$13.63** with Lowe's Pay [Learn How](#)

[Shop the Collection](#)

High-quality composite top and bottom rail kit with aluminum balusters Protected by the Trex 25-year Limited Residential Warranty to provide peace of mind for years to come
72-in Length x 2.75-in Width x 36-in Height are the actual dimensions for a horizontal rail section when fully assembled

Manufacturer Color/Finish: Charcoal Black

		
\$151.00	\$102.00	\$151.00

Pickup
Ready within **3 hrs**

Delivery
Get it by **Thu, Feb 1**

 **FREE Pickup** at Greenland Lowe's

 **29 in Stock** Aisle 18 | Bay 8

[Check Other Stores](#)

- +

 In-use/lifestyle images – accessories not included

 **Easy & Free Returns**
Return your new, unused item in-store or ship it back to us free of charge. [Learn More](#)

Trex Enhance 6-ft x 2.75-in x 36-in Charcoal Black Composite Deck Rail Kit **\$151.00**

[Shop Trex](#)  269

#1 Home Improvement Retailer



What can we help you find today?



Portsmouth 9PM

03801

Home / Lumber & Composites / Decking / Deck Boards / Deck Board Samples

Internet # 302673466 Model # PGS90000 UPC Code # 652835215137

Top Rated

Trex

Select 1 in. x 6 in. x 1 ft. Pebble Grey Composite Deck Board Sample

★★★★★ (186) Questions & Answers (299)

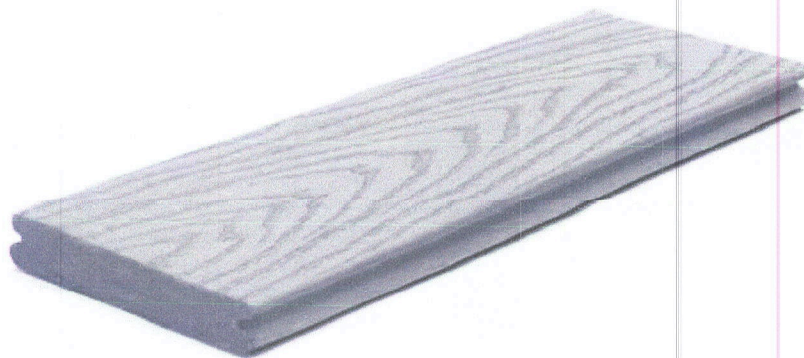
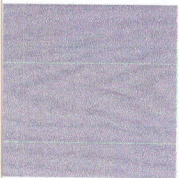
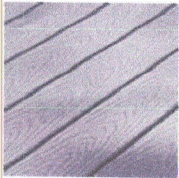
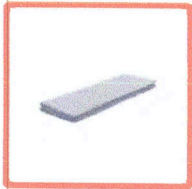

Menu



Quotes



Lists



Scott