

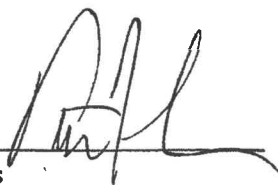

Letter of Authorization

We, The Walter D. Hett Trust, Walter D. Hett, Trustee, C/O Peter Saari, Esquire, as owner of certain real property situated in Portsmouth, NH further described as a parcel of land consisting of 44 +/- acres of land, with all improvements, which is located at 340 Banfield Road, Portsmouth, NH and also shown in Town of Portsmouth Assessor Tax Map 256, Lot 2, and as further described in the deed recorded at the Rockingham County Registry of Deeds Book 4553, Page 0432 recorded on 09/23/2005 do hereby authorize Green & Company Building and Development Corp. and its Affiliates, Agents, Assigns and Engineers to act on our behalf and to appear before the zoning board of adjustment and/or the planning board of said city/town and/or any of its boards or commissions, in our behalf for the purpose of seeking any regulatory relief that may be requested by the person we have above authorized, including variances, special exceptions, dimensional waivers, site plan approval, lot line adjustment approval and subdivision approval, hereby ratifying any actions taken by him/her/them to obtain any such relief. We authorize Green & Company Building and Development Corp. and its Affiliates, Agents, Assigns and Engineers to act in our behalf in all matters concerning the development and approval process, without limitation, for the above stated property, to include any required signatures.

We shall cooperate fully with Green & Company Building and Development Corp. and its Affiliates, Agents, Assigns and Engineers in seeking timely public approvals and for the completion of the sale contemplated herein. We agree to use our good faith efforts to provide any assistance we reasonably can to Green & Company Building and Development Corp. and its Affiliates, Agents, Assigns and Engineers throughout the development process, including but not limited to signing permit applications as needed.

Witness

Owner Walter D. Hett, Trustee
The Walter D. Hett Trust

4-30-19
Date

#	DOCUMENT	EXECUTIVE SUMMARY	TOTAL PAGES
01	Executive Summary of Submittal	<i>see pgs. 1-3</i>	3
02	Site Plan Check List		7
03	Subdivision Check List		6
04	Conditional Use Letters from Law Office of John Kuzinevich dated 12/27/19 and 5/15/20 (CUP)		8
05	Waiver Request Letter (Site Review and Subdivision)		1
06	Traffic Memorandum (Site Review and Subdivision)	<i>see pg. 4</i>	9
07	Plan Set of the "The Village at Banfield Woods", dated Sep. 25, 2019, last revised May 5, 2020 (Site Review, Subdivision, CUP)		50
08	Condominium Documents (Site Review and Subdivision)		32
09	Architectural Plans & Renderings (Site Review and Subdivision)		44
10	Letter Addressing TAC Conditions of Approval (Site Review and Subdivision)		6
11	Landscape Summary and Renderings of the Village at Banfield Woods (Site Review, Subdivision, CUP)	<i>see pg. 1</i>	18
12	August Consulting, PLLC Peer Review Summary (Site Review, Subdivision, CUP)	<i>see pgs. 1+2</i>	2
13	Site Development Intensity Chart	<i>see pg. 1</i>	1
SOILS / WETLANDS			
14	Executive Summary of Wetlands, Soils, Septic Test Pits, Septic Perc Tests, Wetland Functions and Values, Direct Impacts to Wetlands, and Impacts to Wildlife Habitat (Site Review, Subdivision, CUP)	<i>see pg. 2</i>	2
15	"Technical Report of Wetland Functions and Values", dated June 27, 2019 (CUP)	<i>see pgs. 19-21</i>	42
16	GES Response to Mark West Third Party Review (CUP)	<i>see pgs. 1-3</i>	10
17	James P. Gove Biography (Site Review, Subdivision, CUP)		1
18	Wetlands Permit Approval (RSA 482-A) and Wetlands and Non-Site-Specific Permit 2020-00344 (Site Review, Subdivision, CUP)		5
19	Overview Layout of Individual Sewage Disposal Systems (ISDS) (Site Review and Subdivision)		4
20	Letter to Juliet Walker, regarding Individual Sewage Disposal Systems (Site Review and Subdivision)	<i>see pg. 3</i>	4
WILDLIFE			
21	New Ecopassages to Help Critters Cross the Roads (Site Review, Subdivision, CUP)		2
22	Rendering of Ecopassage at The Village at Banfield Woods (Site Review, Subdivision, CUP)		1
23	Wildlife Study from Normandeau Associates (Site Review, Subdivision, CUP)	<i>see pgs. 2+9</i>	54
24	Wildlife Study from Oak Hill Environmental Services (Site Review, Subdivision, CUP)	<i>see pgs. 1-2, 6</i>	22
25	Letter to Peter Britz - Changes Made to Address Conservation Committee Comments (CUP)		2
DRAINAGE			
26	Drainage Analysis (Site Review and Subdivision)	<i>see pg. D9</i>	204
27	Operation and Maintenance Manual (Site Review and Subdivision)	<i>see pg. 10</i>	72
28	Memo from ACF Environmental and e-mail from ADS containing projects where underground Stormwater Treatment Systems have been installed in the groundwater table with liners (Site Review, Subdivision, CUP)	<i>see pg. 1</i>	2
29	Technical Memorandum: R-Tank Drainage System - Waterstone Engineering (Site Review, Subdivision, CUP)	<i>see pgs. 1-2</i>	2
30	Third-Party Drainage Review, Keach-Nordstrom Associates, Inc. (Site Review, Subdivision, CUP)	<i>see pgs. 5-6</i>	6
31a	TFMoran Letter to CMA - Final Stormwater Review (Site Review and Subdivision)	<i>see pgs. 3-4</i>	4
31b	Email from William Straub - CMA Concurrence with TFM Drainage Design (Site Review, Subdivision)		2
32	Letter from ACF - Maintenance and Operation of the R-Tank Systems (Site Review and Subdivision)	<i>see pgs. 1-2</i>	2
33	Letter from Severino - Reliability of Underground Stormwater Treatment Systems (Site Review and Subdivision)	<i>see pgs. 1,2,3</i>	3
34	Letter from Keach-Nordstrom Associates - R-Tank Use and Maintenance (Site Review and Subdivision).	<i>see pgs. 3+4</i>	4



Civil Engineers
Structural Engineers
Traffic Engineers
Land Surveyors
Landscape Architects
Scientists

The Village at Banfield Woods **Executive Summary of Submittal**

We are pleased to present you with a proposal for an Open Space Planned Unit Development (OSPUD) of 22 single-family dwelling units to be served by a private road which will be built to town standards.

Over the past 12 months, this project has been thoroughly reviewed by City Staff, the Technical Advisory Committee, Conservation Commission, DPW, and Third-Party reviewers. During this review process, topics of discussion were impacts to wildlife, density, and the drainage system chosen. In our attached package you will find detailed information and reports addressing all of these concerns, which we have also summarized below.

We are proposing 22-units where 23.7 units are allowed per zoning to maximize open space, reduce environmental impact, and create a neighborhood with ample yard space and landscaping. These units are spaced 30+' apart, which is typical in many conservation subdivisions. Where density pertains to wildlife, wildlife is minimally impacted by this OSPUD and whether there are 22, 23, or 24 units, there is an insignificant difference in the impact to wildlife, as referenced in the attached reports from wildlife experts. Furthermore, over 56% of the site is uplands. We have proposed an R-tank drainage system to manage the stormwater because it is a low impact design that has no impacts on the wetlands or wetland buffers.

Please see below summary on density, drainage, and wildlife, and you will find all supporting information, reports, and plans, in our attached submittal package.

Density:

Pursuant to section 10.723 of the Portsmouth Zoning Ordinance, this property will support almost 24 units (23.7 units). Rather than maximize the site density, the developer is proposing 22 units to maximize greenspace, reduce environmental impacts, and enhance the overall community layout. The layout proposed is based on Green & Company's 35+ years of developing similar successful residential neighborhoods throughout New Hampshire.

As you can see in the "Site Development Intensity Chart" (Document #13), only 7.2 acres, or 16% of the property is developed. 99.54% of the wetland is not impacted, and 71.31% of the upland is not developed. This is far from a high-intensity development. In actuality, this is a low-intensity community where 84% of the total acreage is left in a natural, undeveloped state. Once constructed, the site coverage (buildings, pavement) will be 5%, leaving 95% of this property as open space.

Less than 1% of the wetland on site is impacted and extensive measures have been made to use low-impact designs throughout the neighborhood to allow for proper drainage and wildlife connectivity. In addition, the developer has proposed extensive landscaping with approximately 250 trees and over 500 shrubs and additional plantings, combined with native species and wetland plantings. This proposed landscaping is in addition to the 84% of the site that will remain in its natural vegetated state. The proposed landscaping is further described in the Landscape Summary and Renderings of the Village at Banfield Woods (Document #11).

Drainage:

We have chosen the R-tank system because it is a low-impact design that has no impact on the wetlands or buffer. It treats the maximum amount of water of any stormwater system that has been proposed or discussed for this site. The gravel wetland that has been mentioned, proposed earlier at a lower location in the road, would have had wetland buffer impacts, and received negative feedback from the Conservation Commission.

TFMoran, Inc.

48 Constitution Drive, Bedford, NH 03110
T(603) 472-4488 www.tfmoran.com



TFMoran, Inc. Seacoast Division

170 Commerce Way—Suite 102, Portsmouth, NH 03801
T(603) 431-2222

Currently, there is a comment questioning a gravel wetland at a higher location in the subdivision, at road station 2+50. This location would leave significant road runoff untreated and create a potential safety hazard. In addition, gravel wetlands require regular maintenance and sometimes need re-building in times of major storms, which is expanded on in the letter from Severino Construction Company (Document #33, Pages 2 &3).

In selecting the R-tank system, one of the driving factors was no site disturbance on the areas outside of the road construction, and no impact on wetlands or wetland buffers. Secondly, it was chosen for the ease of inspection and maintenance of the R-tank system. The system is designed with inspection ports that are easily accessible, and maintenance ports that are designed to easily flush the system using conventional equipment, also expanded upon in the letter from Severino Construction Company.

Further information supporting the R-tank drainage system is provided in the application package. Please refer to our letter to CMA dated June 1, 2020 (Document #31a), letter from ACF dated May 21, 2020 addressing simplicity of maintenance and operation (Document #32), where you can also find a long list of location where these systems have been installed and have been successfully in operation for many years, letter from Severino Construction Company dated May 22, 2020 addressing the reliability of the R-tank system (Document #33), letter from Keach-Nordstrom Associates, Inc dated May 6, 2020 concerning R-tank use and maintenance (Document #30, Summary Pages 5 + 6), and letter from Waterstone Engineering (Document #29, Summary Page 1). There is also a 2nd letter from Keach Nordstrom dated May 29, 2020 addressing the issues with putting a gravel wetland at station 2+50. (Document #34, page 3)

We have received New Hampshire Department of Environmental Services Wetlands Permit Approval # 2020-00344 (Document #18), dredge and fill for a minor impact for the wetland crossing at the entrance of the community. This is a minor wetland impact permit, and no other wetland permits are required.

Wildlife:

In discussions with the Conservation Commission there was concern with wildlife connectivity. With the assistance of several expert wildlife consultants, Green & Company addressed these concerns extensively. Based on the recommendations of three wildlife consultants, we modified the original design by adding daylight eco passage (Document #22) under the road to allow small wildlife to be able to move safely and actively throughout the site. The retaining walls at the wildlife corridor were lowered from 8' to 2' and guard rails were removed to allow for large mammals to be able to cross without barriers. The wetland buffer impact was reduced, and we provided special grates on the pre-treatment catch basins to keep small mammals and amphibians from falling in. Over 83% of the total acreage is left in a natural, undeveloped state and will retain its natural vegetation and existing environmental characteristics.

In addition to the wildlife report prepared by Gove Environmental Services (Document #16, Summary Pages 1-3), the applicant had two additional wildlife studies and reports prepared by Normandeau and Associates (Document #23, Summary Pages 2 + 9), a national leader in environmental consulting services, and Oak Hill Environmental Services (Document #24, Summary Pages 1-2, 6), a well-respected NH Environmental Services Firm which can be found in our submission package.

You will find in our attached submission package all the supporting documentation, reports, and plans. Since there are a number of attachments, in order to make efficient use of your time we have highlighted and boxed the executive summary/conclusion which details the most important points of the reports. The page numbers of these summaries can be found in the table of contents.



City of Portsmouth, New Hampshire

Site Plan Application Checklist

This site plan application checklist is a tool designed to assist the applicant in the planning process and for preparing the application for Planning Board review. A pre-application conference with a member of the planning department is strongly encouraged as additional project information may be required depending on the size and scope. The applicant is cautioned that this checklist is only a guide and is not intended to be a complete list of all site plan review requirements. Please refer to the Site Plan review regulations for full details.

Applicant Responsibilities (Section 2.5.2): Applicable fees are due upon application submittal along with required attachments. The application shall be complete as submitted and provide adequate information for evaluation of the proposed site development. Waiver requests must be submitted in writing with appropriate justification.

The Walter D. Hett Trust /

Name of Owner/Applicant: Green & Company Real Estate Date Submitted: 06/16/20

Phone Number: 603-964-7572 E-mail: grousewing1@gmail.com

Site Address: 0 Banfield Road Map: 256 Lot: 2

Zoning District: Single Residence A Lot area: 1,955,150 sq. ft.

Application Requirements			
<input checked="" type="checkbox"/>	Required Items for Submittal	Item Location (e.g. Page or Plan Sheet/Note #)	Waiver Requested
<input type="checkbox"/>	Fully executed and signed Application form. (2.5.2.3)	Submitted Online	N/A
<input type="checkbox"/>	All application documents, plans, supporting documentation and other materials provided in digital Portable Document Format (PDF). (2.5.2.8)	Submitted Online	N/A

Site Plan Review Application Required Information			
<input checked="" type="checkbox"/>	Required Items for Submittal	Item Location (e.g. Page/line or Plan Sheet/Note #)	Waiver Requested
<input type="checkbox"/>	Statement that lists and describes "green" building components and systems. (2.5.3.1A)	N/A	
<input type="checkbox"/>	Gross floor area and dimensions of all buildings and statement of uses and floor area for each floor. (2.5.3.1B)	See Architectural Plans	N/A
<input type="checkbox"/>	Tax map and lot number, and current zoning of all parcels under Site Plan Review. (2.5.3.1C)	S-03	N/A
<input type="checkbox"/>	Owner's name, address, telephone number, and signature. Name, address, and telephone number of applicant if different from owner. (2.5.3.1D)	C-00 and Letter of Authorization	N/A

Site Plan Review Application Required Information

<input checked="" type="checkbox"/>	Required Items for Submittal	Item Location (e.g. Page/line or Plan Sheet/Note #)	Waiver Requested
<input type="checkbox"/>	Names and addresses (including Tax Map and Lot number and zoning districts) of all direct abutting property owners (including properties located across abutting streets) and holders of existing conservation, preservation or agricultural preservation restrictions affecting the subject property. (2.5.3.1E)	S-03	N/A
<input type="checkbox"/>	Names, addresses and telephone numbers of all professionals involved in the site plan design. (2.5.3.1F)	C-00	N/A
<input type="checkbox"/>	List of reference plans. (2.5.3.1G)	S-03	N/A
<input type="checkbox"/>	List of names and contact information of all public or private utilities servicing the site. (2.5.3.1H)	C-00/C-01	N/A

Site Plan Specifications

<input checked="" type="checkbox"/>	Required Items for Submittal	Item Location (e.g. Page/line or Plan Sheet/Note #)	Waiver Requested
<input type="checkbox"/>	Full size plans shall not be larger than 22 inches by 34 inches with match lines as required, unless approved by the Planning Director. Submittals shall be a minimum of 11 inches by 17 inches as specified by Planning Dept. staff. (2.5.4.1A)	Provided on all plan sheets	N/A
<input type="checkbox"/>	Scale: Not less than 1 inch = 60 feet and a graphic bar scale shall be included on all plans. (2.5.4.1B)	Provided on all plan sheets except overall views	N/A
<input type="checkbox"/>	GIS data should be referenced to the coordinate system New Hampshire State Plane, NAD83 (1996), with units in feet. (2.5.4.1C)	All Sheets	N/A
<input type="checkbox"/>	Plans shall be drawn to scale. (2.5.4.1D)	Provided on all plan sheets	N/A
<input type="checkbox"/>	Plans shall be prepared and stamped by a NH licensed civil engineer. (2.5.4.1D)	C-01 - C-15, C-21 - C-43	N/A
<input type="checkbox"/>	Wetlands shall be delineated by a NH certified wetlands scientist and so stamped. (2.5.4.1E)	S-01	N/A
<input type="checkbox"/>	Title (name of development project), north point, scale, legend. (2.5.4.2A)	Provided on all plan sheets	N/A
<input type="checkbox"/>	Date plans first submitted, date and explanation of revisions. (2.5.4.2B)	Provided on all plan sheets	N/A
<input type="checkbox"/>	Individual plan sheet title that clearly describes the information that is displayed. (2.5.4.2C)	Provided on all plan sheets	N/A
<input type="checkbox"/>	Source and date of data displayed on the plan. (2.5.4.2D)	S-01	N/A

Site Plan Specifications

<input checked="" type="checkbox"/>	Required Items for Submittal	Item Location (e.g. Page/line or Plan Sheet/Note #)	Waiver Requested
<input type="checkbox"/>	A note shall be provided on the Site Plan stating: "All conditions on this Plan shall remain in effect in perpetuity pursuant to the requirements of the Site Plan Review Regulations." (2.5.4.2E)	C-04	N/A
<input type="checkbox"/>	Plan sheets submitted for recording shall include the following notes: a. "This Site Plan shall be recorded in the Rockingham County Registry of Deeds." b. "All improvements shown on this Site Plan shall be constructed and maintained in accordance with the Plan by the property owner and all future property owners. No changes shall be made to this Site Plan without the express approval of the Portsmouth Planning Director." (2.13.3)	S-03, C-04, C-16	N/A
<input type="checkbox"/>	Plan sheets showing landscaping and screening shall also include the following additional notes: a. "The property owner and all future property owners shall be responsible for the maintenance, repair and replacement of all required screening and landscape materials." b. "All required plant materials shall be tended and maintained in a healthy growing condition, replaced when necessary, and kept free of refuse and debris. All required fences and walls shall be maintained in good repair." c. "The property owner shall be responsible to remove and replace dead or diseased plant materials immediately with the same type, size and quantity of plant materials as originally installed, unless alternative plantings are requested, justified and approved by the Planning Board or Planning Director." (2.13.4)	C-16	N/A

Site Plan Specifications – Required Exhibits and Data

<input checked="" type="checkbox"/>	Required Items for Submittal	Item Location (e.g. Page/line or Plan Sheet/Note #)	Waiver Requested
	1. Existing Conditions: (2.5.4.3A)		
<input type="checkbox"/>	a. Surveyed plan of site showing existing natural and built features;	S-01	
<input type="checkbox"/>	b. Zoning boundaries;	S-01	
<input type="checkbox"/>	c. Dimensional Regulations;	S-01, Note 4	
<input type="checkbox"/>	d. Wetland delineation, wetland function and value assessment;	S-01, Attached	
<input type="checkbox"/>	e. SFHA, 100-year flood elevation line and BFE data.	S-01	
	2. Buildings and Structures: (2.5.4.3B)		
<input type="checkbox"/>	a. Plan view: Use, size, dimensions, footings, overhangs, 1st fl. elevation;	Attached Architectural & ISDS Plans	
<input type="checkbox"/>	b. Elevations: Height, massing, placement, materials, lighting, façade treatments;	Attached Architectural Plan C-20A - C-23	
<input type="checkbox"/>	c. Total Floor Area;	Attached Architectural Plans	
<input type="checkbox"/>	d. Number of Usable Floors;	Attached Architectural Plans	
<input type="checkbox"/>	e. Gross floor area by floor and use.	Attached Architectural Plans	
	3. Access and Circulation: (2.5.4.3C)		
<input type="checkbox"/>	a. Location/width of access ways within site;	C-04 - C-07	
<input type="checkbox"/>	b. Location of curbing, right of ways, edge of pavement and sidewalks;	C-04 - C-07	
<input type="checkbox"/>	c. Location, type, size and design of traffic signing (pavement markings);	C-04 - C-07	
<input type="checkbox"/>	d. Names/layout of existing abutting streets;	S-01	
<input type="checkbox"/>	e. Driveway curb cuts for abutting prop. and public roads;	S-01, C-04	
<input type="checkbox"/>	f. If subdivision; Names of all roads, right of way lines and easements noted;	S-03	
<input type="checkbox"/>	g. AASHTO truck turning templates, description of minimum vehicle allowed being a WB-50 (unless otherwise approved by TAC).	C-28 - C-31	YES
	4. Parking and Loading: (2.5.4.3D)		
<input type="checkbox"/>	a. Location of off street parking/loading areas, landscaped areas/buffers;	C-04 - C-07/C-16 - C-19	
<input type="checkbox"/>	b. Parking Calculations (# required and the # provided).	C-04	
	5. Water Infrastructure: (2.5.4.3E)		
<input type="checkbox"/>	a. Size, type and location of water mains, shut-offs, hydrants & Engineering data;	C-12 - C-15	
<input type="checkbox"/>	b. Location of wells and monitoring wells (include protective radii).	N/A	
	6. Sewer Infrastructure: (2.5.4.3F)		
<input type="checkbox"/>	a. Size, type and location of sanitary sewage facilities & Engineering data.	C-12 - C-15 and ISDS Plans	
	7. Utilities: (2.5.4.3G)		
<input type="checkbox"/>	a. The size, type and location of all above & below ground utilities;	C-12 - C-15	
<input type="checkbox"/>	b. Size type and location of generator pads, transformers and other fixtures.	C-12 - C-15	

Site Plan Specifications – Required Exhibits and Data

<input checked="" type="checkbox"/>	Required Items for Submittal	Item Location (e.g. Page/line or Plan Sheet/Note #)	Waiver Requested
<input type="checkbox"/>	8. Solid Waste Facilities: (2.5.4.3H)		
<input type="checkbox"/>	a. The size, type and location of solid waste facilities.	N/A	
<input type="checkbox"/>	9. Storm water Management: (2.5.4.3I)		
<input type="checkbox"/>	a. The location, elevation and layout of all storm-water drainage.	C-08 - C-11	
<input type="checkbox"/>	10. Outdoor Lighting: (2.5.4.3J)		
<input type="checkbox"/>	a. Type and placement of all lighting (exterior of building, parking lot and any other areas of the site) and; b. photometric plan.	C-20A - C20C	
<input type="checkbox"/>	11. Indicate where dark sky friendly lighting measures have been implemented. (10.1)	C-20A - C20C	
<input type="checkbox"/>	12. Landscaping: (2.5.4.3K)		
<input type="checkbox"/>	a. Identify all undisturbed area, existing vegetation and that which is to be retained;	P-01, C-16 - C-19	
<input type="checkbox"/>	b. Location of any irrigation system and water source.	N/A	
<input type="checkbox"/>	13. Contours and Elevation: (2.5.4.3L)		
<input type="checkbox"/>	a. Existing/Proposed contours (2 foot minimum) and finished grade elevations.	C-08 - C-11	
<input type="checkbox"/>	14. Open Space: (2.5.4.3M)		
<input type="checkbox"/>	a. Type, extent and location of all existing/proposed open space.	S-03	
<input type="checkbox"/>	15. All easements, deed restrictions and non-public rights of ways. (2.5.4.3N)	S-03	
<input type="checkbox"/>	16. Location of snow storage areas and/or off-site snow removal. (2.5.4.3O)	C-04	
<input type="checkbox"/>	17. Character/Civic District (All following information shall be included): (2.5.4.3P)	N/A	
<input type="checkbox"/>	a. Applicable Building Height (10.5A21.20 & 10.5A43.30);		
<input type="checkbox"/>	b. Applicable Special Requirements (10.5A21.30);		
<input type="checkbox"/>	c. Proposed building form/type (10.5A43);		
<input type="checkbox"/>	d. Proposed community space (10.5A46).		

Other Required Information			
<input checked="" type="checkbox"/>	Required Items for Submittal	Item Location (e.g. Page/line or Plan Sheet/Note #)	Waiver Requested
<input type="checkbox"/>	Traffic Impact Study or Trip Generation Report, as required. <i>(Four (4) hardcopies of the full study/report and Six (6) summaries to be submitted with the Site Plan Application) (3.2.1-2)</i>	Attached	
<input type="checkbox"/>	Indicate where Low Impact Development Design practices have been incorporated. (7.1)	See Drainage Analysis	
<input type="checkbox"/>	Indicate whether the proposed development is located in a wellhead protection or aquifer protection area. Such determination shall be approved by the Director of the Dept. of Public Works. (7.3.1)	See Drainage Analysis	
<input type="checkbox"/>	Indicate where measures to minimize impervious surfaces have been implemented. (7.4.3)	See Drainage Analysis	
<input type="checkbox"/>	Calculation of the maximum effective impervious surface as a percentage of the site. (7.4.3.2)	C-04	
<input type="checkbox"/>	Stormwater Management and Erosion Control Plan. <i>(Four (4) hardcopies of the full plan/report and Six (6) summaries to be submitted with the Site Plan Application) (7.4.4.1)</i>	C-8 - C-11	

Final Site Plan Approval Required Information			
<input checked="" type="checkbox"/>	Required Items for Submittal	Item Location (e.g. Page/line or Plan Sheet/Note #)	Waiver Requested
<input type="checkbox"/>	All local approvals, permits, easements and licenses required, including but not limited to: <ul style="list-style-type: none"> a. Waivers; b. Driveway permits; c. Special exceptions; d. Variances granted; e. Easements; f. Licenses. (2.5.3.2A)	C-00	
<input type="checkbox"/>	Exhibits, data, reports or studies that may have been required as part of the approval process, including but not limited to: <ul style="list-style-type: none"> a. Calculations relating to stormwater runoff; b. Information on composition and quantity of water demand and wastewater generated; c. Information on air, water or land pollutants to be discharged, including standards, quantity, treatment and/or controls; d. Estimates of traffic generation and counts pre- and post-construction; e. Estimates of noise generation; f. A Stormwater Management and Erosion Control Plan; g. Endangered species and archaeological / historical studies; h. Wetland and water body (coastal and inland) delineations; i. Environmental impact studies. (2.5.3.2B)	Drainage Analysis ISDS Plans N/A Traffic Memorandum N/A C-08 - C-11, C-23 - C-25 See 11/19 Gove Report S-01 Attached	

Final Site Plan Approval Required Information

<input checked="" type="checkbox"/>	Required Items for Submittal	Item Location (e.g. Page/line or Plan Sheet/Note #)	Waiver Requested
<input type="checkbox"/>	A document from each of the required private utility service providers indicating approval of the proposed site plan and indicating an ability to provide all required private utilities to the site. (2.5.3.2D)	Pending	
<input type="checkbox"/>	A list of any required state and federal permit applications required for the project and the status of same. (2.5.3.2E)	C-00	

Applicant's Signature:

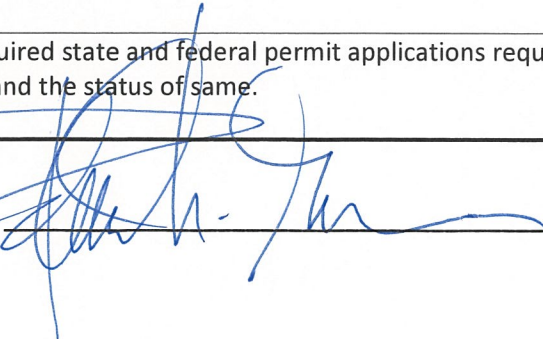

Date:

6/18/20



City of Portsmouth, New Hampshire

Subdivision Application Checklist

This subdivision application checklist is a tool designed to assist the applicant in the planning process and for preparing the application for Planning Board review. A pre-application conference with a member of the planning department is strongly encouraged as additional project information may be required depending on the size and scope. The applicant is cautioned that this checklist is only a guide and is not intended to be a complete list of all subdivision review requirements. Please refer to the Subdivision review regulations for full details.

Applicant Responsibilities (Section III.C): Applicable fees are due upon application submittal along with required number of copies of the Preliminary or final plat and supporting documents and studies. Please consult with Planning staff for submittal requirements.

Owner: The Walter D. Hett Trust Date Submitted: 06/16/20

Applicant: Green & Company Real Estate

Phone Number: 603-964-7572 E-mail: grousewing1@gmail.com

Site Address 1: 0 Banfield Road Map: 256 Lot: 2

Site Address 2: _____ Map: _____ Lot: _____

Application Requirements			
<input checked="" type="checkbox"/>	Required Items for Submittal	Item Location (e.g. Page or Plan Sheet/Note #)	Waiver Requested
<input type="checkbox"/>	Completed Application form. (III.C.2-3)	Submitted Online	N/A
<input type="checkbox"/>	All application documents, plans, supporting documentation and other materials provided in digital Portable Document Format (PDF). (III.C.4)	Submitted Online	N/A

Requirements for Preliminary/Final Plat				
<input checked="" type="checkbox"/>	Required Items for Submittal	Item Location (e.g. Page/line or Plan Sheet/Note #)	Required for Preliminary / Final Plat	Waiver Requested
<input type="checkbox"/>	Name and address of record owner, any option holders, descriptive name of subdivision, engineer and/or surveyor or name of person who prepared the plat. (Section IV.1/V.1)	C-00	<input checked="" type="checkbox"/> Preliminary Plat <input checked="" type="checkbox"/> Final Plat	N/A

Requirements for Preliminary/Final Plat				
<input checked="" type="checkbox"/>	Required Items for Submittal	Item Location (e.g. Page/line or Plan Sheet/Note #)	Required for Preliminary / Final Plat	Waiver Requested
<input type="checkbox"/>	<p>Preliminary Plat Names and addresses of all adjoining property owners. (Section IV.2)</p> <p>Final Plat Names and addresses of all abutting property owners, locations of buildings within one hundred (100) feet of the parcel, and any new house numbers within the subdivision. (Section V.2)</p>	S-03	<input checked="" type="checkbox"/> Preliminary Plat <input checked="" type="checkbox"/> Final Plat	N/A
<input type="checkbox"/>	North point, date, and bar scale. (Section IV.3/V.3)	Provided on all Plan Sheets	<input checked="" type="checkbox"/> Preliminary Plat <input checked="" type="checkbox"/> Final Plat	N/A
<input type="checkbox"/>	Zoning classification and minimum yard dimensions required. (Section IV.4/V.4)	S-03, Note 4	<input checked="" type="checkbox"/> Preliminary Plat <input checked="" type="checkbox"/> Final Plat	N/A
<input type="checkbox"/>	<p>Preliminary Plat Scale (not to be smaller than one hundred (100) feet = 1 inch) and location map (at a scale of 1" = 1000'). (Section IV.5)</p> <p>Final Plat Scale (not to be smaller than 1"=100'), Location map (at a scale of 1"=1,000') showing the property being subdivided and its relation to the surrounding area within a radius of 2,000 feet. Said location map shall delineate all streets and other major physical features that may either affect or be affected by the proposed development. (Section V.5)</p>	C-00 & S-03	<input checked="" type="checkbox"/> Preliminary Plat <input checked="" type="checkbox"/> Final Plat	N/A
<input type="checkbox"/>	Location and approximate dimensions of all existing and proposed property lines including the entire area proposed to be subdivided, the areas of proposed lots, and any adjacent parcels in the same ownership. (Section IV.6)	S-03	<input checked="" type="checkbox"/> Preliminary Plat <input checked="" type="checkbox"/> Final Plat	
<input type="checkbox"/>	Dimensions and areas of all lots and any and all property to be dedicated or reserved for schools, parks, playgrounds, or other public purpose. Dimensions shall include radii and length of all arcs and calculated bearing for all straight lines. (Section V.6/ IV.7)	S-03	<input checked="" type="checkbox"/> Preliminary Plat <input checked="" type="checkbox"/> Final Plat	N/A
<input type="checkbox"/>	Location, names, and present widths of all adjacent streets, with a designation as to whether public or private and approximate location of existing utilities to be used. Curbs and sidewalks shall be shown. (Section IV.8/V.7)	S-01	<input checked="" type="checkbox"/> Preliminary Plat <input checked="" type="checkbox"/> Final Plat	

Requirements for Preliminary/Final Plat				
<input checked="" type="checkbox"/>	Required Items for Submittal	Item Location (e.g. Page/line or Plan Sheet/Note #)	Required for Preliminary / Final Plat	Waiver Requested
<input type="checkbox"/>	Location of significant physical features, including bodies of water, watercourses, wetlands, railroads, important vegetation, stone walls and soils types that may influence the design of the subdivision. (Section IV.9/V.8)	S-01	<input checked="" type="checkbox"/> Preliminary Plat <input checked="" type="checkbox"/> Final Plat	
<input type="checkbox"/>	Preliminary Plat Proposed locations, widths and other dimensions of all new streets and utilities, including water mains, storm and sanitary sewer mains, catch basins and culverts, street lights, fire hydrants, sewerage pump stations, etc. (Section IV.10) Final Plat Proposed locations and profiles of all proposed streets and utilities, including water mains, storm and sanitary sewer mains, catchbasins and culverts, together with typical cross sections. Profiles shall be drawn to a horizontal scale of 1"=50' and a vertical scale of 1"=5', showing existing centerline grade, existing left and right sideline grades, and proposed centerline grade. (Section V.9)	C-04 - C-07 C-08 - C-11 C-12 - C-15 C-21 - C-22 C-36	<input checked="" type="checkbox"/> Preliminary Plat <input checked="" type="checkbox"/> Final Plat	
<input type="checkbox"/>	When required by the Board, the plat shall be accompanied by profiles of proposed street grades, including extensions for a reasonable distance beyond the subject land; also grades and sizes of proposed utilities. (Section IV.10)	C-21 - C-22	<input checked="" type="checkbox"/> Preliminary Plat <input checked="" type="checkbox"/> Final Plat	
<input type="checkbox"/>	Base flood elevation (BFE) for subdivisions involving greater than five (5) acres or fifty (50) lots. (Section IV.11)	S-03, Note 3	<input checked="" type="checkbox"/> Preliminary Plat <input checked="" type="checkbox"/> Final Plat	
<input type="checkbox"/>	For subdivisions of five (5) lots or more, or at the discretion of the Board otherwise, the preliminary plat shall show contours at intervals no greater than two (2) feet. Contours shall be shown in dotted lines for existing natural surface and in solid lines for proposed final grade, together with the final grade elevations shown in figures at all lot corners. If existing grades are not to be changed, then the contours in these areas shall be solid lines. (Section IV.12/ V.12)	S-01 (existing) C-08 - C-11 (proposed)	<input checked="" type="checkbox"/> Preliminary Plat <input checked="" type="checkbox"/> Final Plat	

Requirements for Preliminary/Final Plat				
<input checked="" type="checkbox"/>	Required Items for Submittal	Item Location (e.g. Page/line or Plan Sheet/Note #)	Required for Preliminary / Final Plat	Waiver Requested
<input type="checkbox"/>	Dates and permit numbers of all necessary permits from governmental agencies from which approval is required by Federal or State law. (Section V.10)	S-00	<input type="checkbox"/> Preliminary Plat <input checked="" type="checkbox"/> Final Plat	
<input type="checkbox"/>	For subdivisions involving greater than five (5) acres or fifty (50) lots, the final plat shall show hazard zones and shall include elevation data for flood hazard zones. (Section V.11)	N/A	<input type="checkbox"/> Preliminary Plat <input checked="" type="checkbox"/> Final Plat	
<input type="checkbox"/>	Location of all permanent monuments. (Section V.12)	S-03	<input type="checkbox"/> Preliminary Plat <input checked="" type="checkbox"/> Final Plat	

General Requirements¹

<input checked="" type="checkbox"/>	Required Items for Submittal	Item Location (e.g. Page/line or Plan Sheet/Note #)	Waiver Requested
<input type="checkbox"/> <input type="checkbox"/> <input type="checkbox"/> <input type="checkbox"/> <input type="checkbox"/>	1. Basic Requirements: (VI.1) a. Conformity to Official Plan or Map b. Hazards c. Relation to Topography d. Planned Unit Development	All Sheets N/A S-01 S-03	
<input type="checkbox"/> <input type="checkbox"/> <input type="checkbox"/> <input type="checkbox"/>	2. Lots: (VI.2) a. Lot Arrangement b. Lot sizes c. Commercial and Industrial Lots	S-03 S-03 N/A	
<input type="checkbox"/> <input type="checkbox"/> <input type="checkbox"/> <input type="checkbox"/> <input type="checkbox"/> <input type="checkbox"/> <input type="checkbox"/> <input type="checkbox"/> <input type="checkbox"/> <input type="checkbox"/> <input type="checkbox"/> <input type="checkbox"/> <input type="checkbox"/> <input type="checkbox"/> <input type="checkbox"/> <input type="checkbox"/> <input type="checkbox"/> <input type="checkbox"/> <input type="checkbox"/> <input type="checkbox"/>	3. Streets: (VI.3) a. Relation to adjoining Street System b. Street Rights-of-Way c. Access d. Parallel Service Roads e. Street Intersection Angles f. Merging Streets g. Street Deflections and Vertical Alignment h. Marginal Access Streets i. Cul-de-Sacs j. Rounding Street Corners k. Street Name Signs l. Street Names m. Block Lengths n. Block Widths o. Grade of Streets p. Grass Strips	S-03 S-03 S-03 S-03 C-04 - C-05 N/A C-04 - C-07, C-21 - C-22 N/A C-07 C-04 - C-07 C-33 TBD N/A N/A C-08 - C-11 C-16 - C-19	Yes
<input type="checkbox"/>	4. Curbing: (VI.4)	C-04 - C-07	
<input type="checkbox"/>	5. Driveways: (VI.5)	C-04 - C-07	
<input type="checkbox"/>	6. Drainage Improvements: (VI.6)	C-08 - C-11	
<input type="checkbox"/>	7. Municipal Water Service: (VI.7)	C-12 - C-15	
<input type="checkbox"/>	8. Municipal Sewer Service: (VI.8)	N/A	
<input type="checkbox"/>	9. Installation of Utilities: (VI.9)		
<input type="checkbox"/> <input type="checkbox"/>	a. All Districts b. Indicator Tape	C-12 - C-15 C-12 - C-15, C34	
<input type="checkbox"/>	10. On-Site Water Supply: (VI.10)	N/A	
<input type="checkbox"/>	11. On-Site Sewage Disposal Systems: (VI.11)	C-12 - C-15, ISDS Plans	
<input type="checkbox"/> <input type="checkbox"/> <input type="checkbox"/> <input type="checkbox"/>	12. Open Space: (VI.12) a. Natural Features b. Buffer Strips c. Parks d. Tree Planting	S-01 S-03 N/A C-16 - C-19	
<input type="checkbox"/> <input type="checkbox"/> <input type="checkbox"/> <input type="checkbox"/>	13. Flood Hazard Areas: (VI.13) a. Permits b. Minimization of Flood Damage c. Elevation and Flood-Proofing Records d. Alteration of Watercourses	N/A	
<input type="checkbox"/>	14. Erosion and Sedimentation Control (VI.14)	C-23 - C-25	

<input checked="" type="checkbox"/>	Required Items for Submittal	Item Location (e.g. Page/line or Plan Sheet/Note #)	Waiver Requested
<input type="checkbox"/>	15. Easements (VI.15)		
<input type="checkbox"/>	a. Utilities	S-03	
<input type="checkbox"/>	b. Drainage		
<input type="checkbox"/>	16. Monuments: (VI.16)	S-03	
<input type="checkbox"/>	17. Benchmarks: (VI.17)	S-03	
<input type="checkbox"/>	18. House Numbers (VI.18)	TBD	

Design Standards			
	Required Items for Submittal	Indicate compliance and/or provide explanation as to alternative design	Waiver Requested
<input type="checkbox"/>	1. Streets have been designed according to the design standards required under Section (VII.1). a. Clearing b. Excavation c. Rough Grade and Preparation of Sub-Grade d. Base Course e. Street Paving f. Side Slopes g. Approval Specifications h. Curbing i. Sidewalks j. Inspection and Methods	YES Except width per TAC recommendation	
<input type="checkbox"/>	2. Storm water Sewers and Other Drainage Appurtenances have been designed according to the design standards required under Section (VII.2). a. Design b. Standards of Construction	YES	
<input type="checkbox"/>	3. Sanitary Sewers have been designed according to the design standards required under Section (VII.3). a. Design b. Lift Stations c. Materials d. Construction Standards	YES	
<input type="checkbox"/>	4. Water Mains and Fire Hydrants have been designed according to the design standards required under Section (VII.4). a. Connections to Lots b. Design and Construction c. Materials d. Notification Prior to Construction	YES	

Applicant's/Representative's Signature: _____

Date: _____

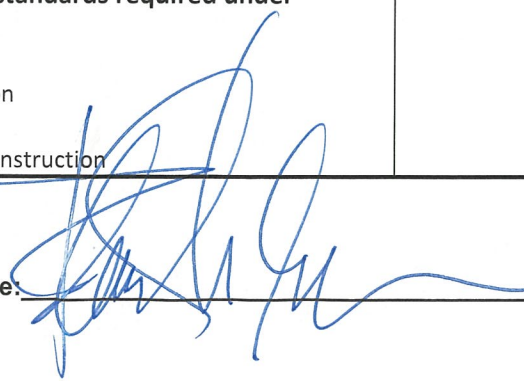

6/18/20

¹ See City of Portsmouth, NH Subdivision Rules and Regulations for details.
Subdivision Application Checklist/April 2019

John Kuzinevich, Esq.
Law Office of John Kuzinevich

71 Gurnet Road
Duxbury, Massachusetts 02332

Telephone: 781 536-8835
Cell: 508 245-2105

E-mail: jjkuz@comcast.net

December 27, 2019

Planning Board of the City of Portsmouth
City Hall
One Junkins Avenue
Portsmouth, NH 03801

Re: Proposed Subdivision, 0 Banfield Road, Portsmouth
Tax Map 256, Lot 2

Conditional Use Permit

Dear Members of the Planning Board:

Please be advised that I represent Green & Company (“Applicant”) concerning the Village at Banfield Woods, a proposed subdivision located at 0 Banfield Road, Portsmouth. This letter will set out the reasons for approval of the requested Conditional Use Permit (CUP).

INTRODUCTION

This is a 45 acre parcel of which the Applicant proposes to build single family homes, clustered pursuant to a condominium, on 7 acres of the property. It proposes 22 houses which is less than the maximum allowed under the Zoning Ordinance.

Access to the uplands, that is the buildable area of the lot, from its frontage on Banfield Road, is through a small strip of wetland and wetland buffer. There are minimal disturbances to both, some temporary and some permanent, solely for creating an access road, which will have little to no impact to the ecosystem.

The Applicant prepared plans with the aim for designing a subdivision with minimal impact. There were a number of meetings with the Conservation Commission, and, in each instance the applicant made changes to the plans including moving the access road to respond to questions or suggestions of the Commission. The effect of this move, again at the Commission’s suggestion, was to reduce some impacts while increasing others. The move was a good compromise of competing conservation interests.

Unfortunately, the Conservation Commission focused principally on two factors in deciding not to recommend the project. First it focused on a fifty foot section of a roadway retaining wall as an impediment to wildlife. The evidence was uncontroverted that this roadway retaining wall was a tiny

portion of both the roadway and the overall site. There was unrefuted testimony that there were other areas of travel for wildlife and that the fifty foot section was not an impediment. Second, the Conservation Commission effectively rubber-stamped the personal and subjective opinion of the Environmental Planner, Peter Britz. In a memorandum to the Board circulated the day before the meeting, the Environmental Planner used incorrect data and unfairly substituted his opinion, against that of the City's own expert, in recommending a denial. Although it appeared that the Commission was still willing to consider the plan, in light of its actions, and the fact that the applicant did not have material ways in which to further address the Commission's impossible requirements, the applicant elected to proceed to Planning Board review without the concurrence of the Conservation Commission.

As will be demonstrated below, the facts present here, and the law, require a CUP issue. This letter will outline the reasons for this conclusion in light of the Ordinance. Incorporated herein are the exhibits and detailed presentation of each of the applicant's experts, as this letter by itself is not intended to go into the same depth as each expert.

LEGAL STANDARDS

Section 10.1017.40 of the Zoning Ordinance requires that a conditional use permit shall be granted provided the criteria set out in Section 10.1017.50 are met. "Shall" is a mandatory word of command which must be followed. Thus, as long as the criteria are met, there is no discretion but to issue the permit. *Appeal of Boyle, Trustee*, 169 N.H. 371 (2016). As will be shown further below, the application meets all criteria. However, before addressing specific sections of the Ordinance, the manner in which it must be interpreted will be addressed in this section.

Zoning ordinances construed as normal ordinances. *Dartmouth Corp. of Alpha Delta v. Town of Hanover*, 169 N.H. 743, 754 (2017). Thus, zoning ordinances are interpreted as written. *Harrington v. Town of Warner*, 152 N.H. 74, 79 (2005); *Hudson v. City of Manchester*, 141 N.H. 420 (1996). In construing the ordinance, the Board must be objective. *Trustees of Dartmouth College v. Town of Hanover*, 198 A.3d 911 (N.H. 2018). Even seemingly subjective standards, such as a "scenic road" must be objectively measured. *Weber v Town of Candia*, 146 N.H. 430, 778 A.2d 402, 408 (2001). Thus a decision must be based on objective evidence. *Id.* It cannot be based on personal opinions or vague concerns. *Ltd. Edition Properties v. Town of Hebron*, 168 N.H. 488 (2011).

This is particularly true for expert testimony. Although the Board may rely on personal knowledge, it cannot ignore uncontroverted expert testimony. *Condos East Corp. v. Town of Conway*, 132 N.H. 431 (1989). *Continental Paving, Inc., v. Town of Litchfield*, 158 N.H. 570 (2009). (ZBA decision). *Trustees of Dartmouth College, supra.*, See: *Appeal of Northern Transmission Line*, 214 A.3d 590, 606 (2019). (This is particularly important here as the Commission's expert substantially agreed with the Applicant's expert, Mr. Gove. Mr. Britz and the Commission chose to ignore both of them.) Decisions cannot be ad hoc. *Trustees of Dartmouth College, supra.*

Finally the Ordinance cannot be used in a manner simply to preserve open space. An owner has the right to lawfully develop his or her property and the failure to allow such development can constitute a taking entitling someone to just compensation paid by the City. *Trustees of Dartmouth College, supra.*

The proposed subdivision is one of the least impactful and more modest use of land than myriads of surrounding subdivisions. Its wetlands disturbance and buffer impact is minimal. It meets all requirements of zoning and does not require a variance. But for the developable land being wetland-locked there would be virtually no disturbance. As it is, the only disturbance is for the smallest reasonable road to cross from the street to the upland. By any objective standard, the applicant is entitled to a CUP.

SPECIFIC STANDARDS FOR CUP

The specific standards for approving a CUP are enumerated in Section 10.1017.50 as follows:

- (1) The land is reasonably suited to the use, activity or alteration.
- (2) There is no alternative location outside the wetland buffer that is feasible and reasonable for the proposed use activity or alteration.
- (3) There will be no adverse impact on the wetland functional values of the site or surrounding properties.
- (4) Alteration of natural vegetative state or managed woodland will occur only to the extent necessary to achieve construction goals.
- (5) The proposal is the alternative with the least adverse impact to areas and environments under the jurisdiction of this Section.
- (6) Any area within the vegetated buffer strip will be returned to a natural state to the extent feasible.

Each will be treated separately below.

THE LAND IS REASONABLY SUITED TO THE USE, ACTIVITY OR ALTERATION.

This standard is somewhat ambiguous as “land” is not defined in the Ordinance and it cannot mean the same as “lot” or “development” which are defined terms. The most reasonable meaning is the land or physical area of the lot for which is affected by the activity for which the permit is sought. In this regard the proposal is overwhelmingly suited for use as a connecting strip of road to allow development of seven acres of uplands. The wetlands and buffer impacts are minimized and are only a minuscule amount of the overall wetlands. Through eco-passages, steps have been taken to preserve connectivity and wetland passages. There is little if any impact and it does not do danger to the entire 45 acre site. Rather, but for the access road, all development is in the uplands and 38 acres are preserved open. It is the least impactful development and meets this criteria.

Conversely, prohibition of the strip of road would be unreasonable. Due to the configuration of the land, a prohibition would prevent development of the entire 45 acre lot. This is patently unreasonable when balanced against minimal impact.

THERE IS NO ALTERNATIVE LOCATION OUTSIDE THE WETLAND BUFFER THAT IS FEASIBLE AND REASONABLE FOR THE PROPOSED USE ACTIVITY OR ALTERATION.

This standard is met as the entire frontage which provides access to the upland consists of wetlands. Thus, to have any development a small area of buffer must be impacted. There simply is no other area of access. Moreover given design constraints and unavailability of additional land, no other approach is possible.

THERE WILL BE NO ADVERSE IMPACT ON THE WETLAND FUNCTIONAL VALUES OF THE SITE OR SURROUNDING PROPERTIES.

Mr. Gove reported extensively how there is minimal impact on wetland functional values. Mr. West, the Conservation Commission's expert agreed. Given that there is no serious or legitimate testimony to the contrary, this point must be met as a matter of law.

ALTERATION OF NATURAL VEGETATIVE STATE OR MANAGED WOODLAND WILL OCCUR ONLY TO THE EXTENT NECESSARY TO ACHIEVE CONSTRUCTION GOALS.

The applicant represents it will cut the least amount of vegetation necessary to meet construction goals. The absolute minimum of wetlands and buffer will be disturbed. Even in the uplands, older and larger trees will be preserved to the extent feasible. This is in the applicant's self-interest as mature trees add value to individual lots. This standard is met.

THE PROPOSAL IS THE ALTERNATIVE WITH THE LEAST ADVERSE IMPACT TO AREAS AND ENVIRONMENTS UNDER THE JURISDICTION OF THIS SECTION.

Importantly, this standard, which is a catch all for various subjects, does not require that there be no impacts by the project - only that they be minimized. Here, all impacts are minimized. Wetlands and buffer have already been addressed.

There was concern over septic systems. Technologically advanced systems are being used and there is sufficient buffer between the wetlands and the leach fields. The septic systems, as described and presented by Gary Spaulding, SSD, will have no anticipated impact on the wetlands.

Animal habitat is being preserved. Studies were done to show animal movement and how the design of the site preserves that movement, through either eco-tunnels or through grades which larger animals can traverse. In order to balance roadway grades, reduce impact on the wetland buffers and promote the eco-tunnels, the proposed roadway was designed with retaining walls. Of concern to the commission was a retaining wall 172' long. 50' of this wall was between 8 and 9.6 high, the remainder being between 1 and 8 feet high. The commission felt large animals, such as deer, could not pass this section of road. However, it is only 50 feet out of a road of 1,400 feet. There are 400 feet of easily crossed road, away from any house, that will not interfere with wildlife. Indeed this is an instance where a short section of higher wall provides the least impact to the environment when all other factors are considered. In addition a four foot by four foot tunnel has been incorporated to encourage the passage of wildlife.

ANY AREA WITHIN THE VEGETATED BUFFER STRIP WILL BE RETURNED TO A NATURAL STATE TO THE EXTENT FEASIBLE.

The applicant represents that it will return any temporarily disturbed areas of the buffer strip to a natural state. Further, the only portion of the vegetated buffer strip to be altered is immediately before and after the wetland crossing. The roadway has been aligned such that 4 trees are proposed to be removed in the vegetated buffer. Thus, this standard is met.

REASONS TO NOT FOLLOW CONSERVATION COMMISSION RECOMMENDATION

There are numerous reasons to disregard Mr. Britz's report dated December 10, 2019 and the Conservation Commission's wholesale adoption of it. First, it is both biased and smacks of personal opinion rather than objective evidence. Bias is evident when every single criteria are denied, even criteria for which Mr. Britz has no expertise. It was not supported by expert testimony and used the wrong plans and alleged impacts. This will respond in order to Mr. Britz's points.

1. The project is reasonable as designed. Wildlife can easily pass through most of the site with only a 50 foot exception. Mr. Britz has no evidence that any development would adversely affect wildlife and yet the applicant's experts were clear in the lack of impact. Moreover, the project does not bisect the site. The existing uplands already bisect the site and the only additional extension of this feature is the short access road. Mr. Britz also fails to mention, that the site, if bisected at all is affected by the preexisting electric transmission line right of way. Further, Mr. Britz does not propose anything to make the site useable or add to its design. This is not surprising since the design is already good and he cannot advance any suggestion.

2. Mr. Britz's conclusion that the applicant has not demonstrated an alternative to the wetland crossing that is reasonable and feasible. This is contradicted by all the plans. These show that crossing the wetlands is the only way to access the upland. Mr. Britz's dream of some magical access appearing just doesn't exist. Again this is a conclusion rooted in bias against development and personal opinion without a factual basis.

3. Mr. Britz is not a wetland scientist. He is not qualified to opine about wetland function and values and his opinion, which contradicts the two wetland scientists who examined the site, must be disregarded. Further it is clear that he is speculating about the effort of homes and runoff as the plans have clear design for appropriate stormwater management. Further, Mr. Britz has exceeded his jurisdiction by focusing on the homes that will be built. This CUP is for a roadway crossing a strip of wetlands and buffer. Mr. Britz fails to even attempt to analyze the actual impact caused by the use for which the CUP is sought.

4. Mr. Britz makes a false statement that the applicant is planning on clear cutting. Based on this he recommends denial. The applicant clearly represented that it would try to save trees and then it would engage in heavy planting to replace those trees that could not be saved. While Mr. Britz acknowledges that the applicant was making efforts to reduce the number of trees cut, without basis, he concludes it is not enough. For perspective, aside from constructing houses on the lots, only 31 trees in a 45 acre site are being removed.

5. Mr. Britz confuses the impact from the CUP with the impact from development. Whether there is one house, several houses or the maximum allowed by zoning, the impact of the CUP does not change as the construction is identical under all scenarios. Mr. Britz points to no specific concern other than he does not like developers maximizing their lots, which in this case is not true as 22 lots are being developed where 23 are allowed. There simply are no standards other than bias and vague concerns. His recommendation cannot stand.

6. Mr. Britz misconstrues the standard concerning mitigation and plantings. The Ordinance does not require an overall mitigation plan. Rather, it requires disturbed areas be replanted to the degree feasible. The applicant has represented that it would do so. There is no basis for Mr. Britz's recommendation.

As can be seen from all of the above, Mr. Britz did not provide a recommendation based on objective evidence. Instead he allowed an antidevelopment bias to make his recommendation untenable. The Conservation Commission erred in endorsing it.

CONCLUSION

By any objective standard, this is a minimal impact proposal. In contrast, denial of the CUP will work a hardship on the applicant as otherwise the upland is inaccessible. The proposal also meets all standards set out in the Ordinance. It should be granted.

Sincerely,

John Kuzinevich

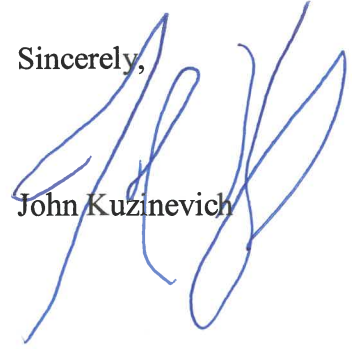
A handwritten signature in blue ink, appearing to read 'John Kuzinevich', is written over the printed name. The signature is stylized and somewhat illegible due to the cursive nature of the handwriting.

Copy to: clients

John Kuzinevich, Esq.
Law Office of John Kuzinevich

71 Gurnet Road
Duxbury, Massachusetts 02332

Telephone: 781 536-8835
Cell: 508 245-2105

E-mail: jjkuz@comcast.net

May 15, 2020

Planning Board of the City of Portsmouth
City Hall
One Junkins Avenue
Portsmouth, NH 03801

Re: Proposed Subdivision, 0 Banfield Road, Portsmouth
Tax Map 256, Lot 2

Conditional Use Permit

Dear Members of the Planning Board:

As you are aware, I represent Green & Company (“Applicant”) concerning the Village at Banfield Woods, a proposed subdivision located at 0 Banfield Road, Portsmouth. On December 27, 2019, I wrote to set out the reasons for approval of the requested Conditional Use Permit (CUP). Since that time, there have been numerous interactions with the Planning Staff and TAC. As a result of those meetings, the Applicant has addressed various concerns and further made significant improvements to the proposed subdivision. In addition, the Applicant obtained further expert evaluations of the proposal. In this letter, I am going to address: (1) the scope of impact by the CUP, (2) the density of the subdivision, and (3) the additional evidence supporting the application.

1. Scope of Impact.

This proposed development requires a CUP to provide access to uplands as the entire frontage of the property is wetlands. A minimally impactful crossing was proposed at the location which would have the least impact to the wetlands and buffer. The crossing does not adversely impact larger animals and three Eco-passages will be installed for smaller animals. Three wildlife experts have found the impact to be minimal. Three drainage experts have found stormwater treatment to be excellent. However, these concerns are for the overall subdivision approval and not the CUP.

Zoning ordinances should not be construed to impact areas beyond the scope of the affected matter. *Town of Amherst v. Cadorette*, 113 N.H. 13 (1973). Thus, in deciding on the CUP, the Board should only consider the impact to the wetlands and buffer. Indeed, a close reading of Section 10.1017.50 establishes the only considerations for granting a CUP are limited to areas “under the jurisdiction of this section.” The jurisdiction is spelled out in Section 10.1013 and is limited to wetlands and buffers. The

CUP is not a referendum on the subdivision as a whole but rather a narrow analysis of impact on a specific area. As established by the various experts and not disputed by the City's peer reviewer, the impact is *de minimus*.

The Conservation Commission, following Mr. Britz' recommendation seemed to turn the inquiry into an overall evaluation of the subdivision. Items such as large animal travel patterns in the upland and similar matters took disproportionate time and distraction. The applicant addressed all appropriate concerns for the CUP and also for the subdivision as a whole. Thus, the CUP should be approved.

2. Density.

Throughout the process, there has been suggestions that the project is too dense. Mr. Britz raised most of his comments based on a goal of reducing density. Under the zoning ordinance, the Applicant as a matter of right can build 23.7 homes. It is only building 22. A Board may not impose density restrictions greater than what is expressed in the statute. *Fiens v. Town of Wilmont*, 154 N.H. 715 (2007). Here all the experts agree that 22 homes is an acceptable density for the site. The City, through its zoning ordinance, as a matter of law, agrees.

3. Additional Evidence.

As indicated in my December 27, 2019 letter, expert evidence cannot be ignored. Since then, the project has been peer reviewed by the City. The applicant also had two additional wildlife studies, two additional drainage reviews, and expert opinion on constructing the drainage system. The applicant further had an independent engineer review the overall project. All findings and opinions were positive that this is a viable subdivision which should gain approval of both the CUP and the site plan. The great weight of this evidence cannot be ignored.

Accordingly, for the reasons above and the evidence in the entire filing, the Applicant requests approval of the CUP.

Sincerely,

/s/ John Kuzinevich

John Kuzinevich

Copy to: clients



Civil Engineers
Structural Engineers
Traffic Engineers
Land Surveyors
Landscape Architects
Scientists

June 23, 2020

Mr. Dexter Legg, Chair
Portsmouth Planning Board
1 Junkins Avenue
Portsmouth, NH 03801

RE: Waiver Requests for Condominium Development, Banfield Road, Tax Map 256, Lot 2

Dear Chairman Legg:

On behalf of our client, Green and Company, we respectfully request the following waivers as part of the submittal of the Village at Banfield Woods Condominium Development:

Waiver Request: for Subdivision Rules and Regulations, Section VI(3)(I) Cul-de-Sacs: “The maximum length of a cul-de-sac shall generally be five hundred (500) feet unless otherwise approved by the Board.”

Explanation: The proposed cul-de-sac is located 900’ from the street. There is no feasible means to create a second access to the uplands on this site without impacting additional wetland and wetland buffer. Each house will have a sprinkler system installed. Additionally, fire hydrants are proposed in two locations along the proposed road to aid in fire suppression. The length of this road was discussed in detail during the conceptual consultation with the Planning Board and three Technical Advisory Committee (TAC) meetings with no objection to its proposed length from either boards or the fire or police department.

Waiver Request: for Site Plan Review Regulations, Article 2.5.4(3)(c) Access and Circulation: “Use current AASHTO truck turning templates descriptions with the minimum vehicle allowed being a WB-50, unless otherwise approved by the TAC”.

Explanation: This is a residential property and not a business. Widening out the entrance and enlarging the cul-de-sac to accommodate a WB-50 (tractor trailer) would create more impervious area, wetland impact and is not required for this site. The roadway as designed can accommodate Portsmouth’s largest fire truck.

We look forward to your review of these waiver requests at the next Planning Board hearing.

Respectfully,
TFMoran, Inc.

J. Corey Colwell, LLS
Principal

JCC/alb

TFMoran, Inc.
48 Constitution Drive, Bedford, NH 03110
T(603) 472-4488 www.tfmoran.com



TFMoran, Inc. Seacoast Division
170 Commerce Way–Suite 102, Portsmouth, NH 03801
T(603) 431-2222

MEMORANDUM

Ref: 1939A

To: Michael Green
Green & Company

From: Stephen G. Pernaw, P.E., PTOE

Subject: Proposed Residential Development
Portsmouth, New Hampshire

Date: June 25, 2019

Thank you for sending along the conceptual site plan that shows a 22-unit residential condominium development on the west side of Banfield Road in Portsmouth, New Hampshire. To assist you with your deliberations with the City Planning Department, our office has conducted a trip generation analysis and preliminary trip distribution analysis for this development. The purpose of this memorandum is to summarize the results of these analyses:

Proposed Development – According to the plan entitled “*Conceptual Site Plan A*” prepared by TFM, Inc. (see Attachment 1), the proposed development involves the construction of 22 detached dwelling units with one point of access on Banfield Road. This new intersection will be located approximately midway between Peverly Hill Road and Constitution Avenue.

Trip Generation - To estimate the quantity of vehicle-trips that will be produced by the proposed residential development, Pernaw & Company, Inc. considered the standard trip generation rates and equations published by the Institute of Transportation Engineers¹ (ITE). Land Use Code LUC 220: Multifamily Housing (Low-Rise) is the most applicable category for a condominium development, and the number of dwelling units was utilized as the independent variable. Table 1 shows that this development will generate approximately 10 (AM) and 12 (PM) vehicle-trips during the weekday commuter peak hour periods (see Attachments 2 & 3). Consequently, this development is clearly not a major traffic generator.

Trip Distribution - The preliminary trip distribution analysis indicates that approximately 50% of the site traffic will travel to/from points north on Banfield Road; with the remainder traveling to/from the south. Figure 1 shows the likely distribution of site traffic on Banfield Road, with the net increase totaling only +6 vehicles during the PM peak hour period. This translates into one additional vehicle every 10 minutes, on average, during the peak hour periods. Hourly increases of this order of magnitude simply will not significantly alter the prevailing traffic operations at nearby intersections.

¹ Institute of Transportation Engineers, *Trip Generation*, 10th Edition (Washington, D.C., 2017)
1939A

Table 1	Trip Generation Summary
----------------	--------------------------------

	22 Residential Condominiums ¹
Weekday Total	
Entering	81 veh
Exiting	<u>81 veh</u>
Total	162 trips
Weekday AM Peak Hour	
Entering	2 veh
Exiting	<u>8 veh</u>
Total	10 trips
Weekday PM Peak Hour	
Entering	8 veh
Exiting	<u>4 veh</u>
Total	12 trips
<hr/>	
Saturday Total	
Entering	90 veh
Exiting	<u>90 veh</u>
Total	180 trips
Saturday Peak Hour	
Entering	8 veh
Exiting	<u>7 veh</u>
Total	15 trips
<hr/>	
Sunday Total	
Entering	69 veh
Exiting	<u>69 veh</u>
Total	138 trips
Sunday Peak Hour	
Entering	8 veh
Exiting	<u>7 veh</u>
Total	15 trips

¹ITE Land Use Code 220 - Multifamily Housing (Low-Rise)

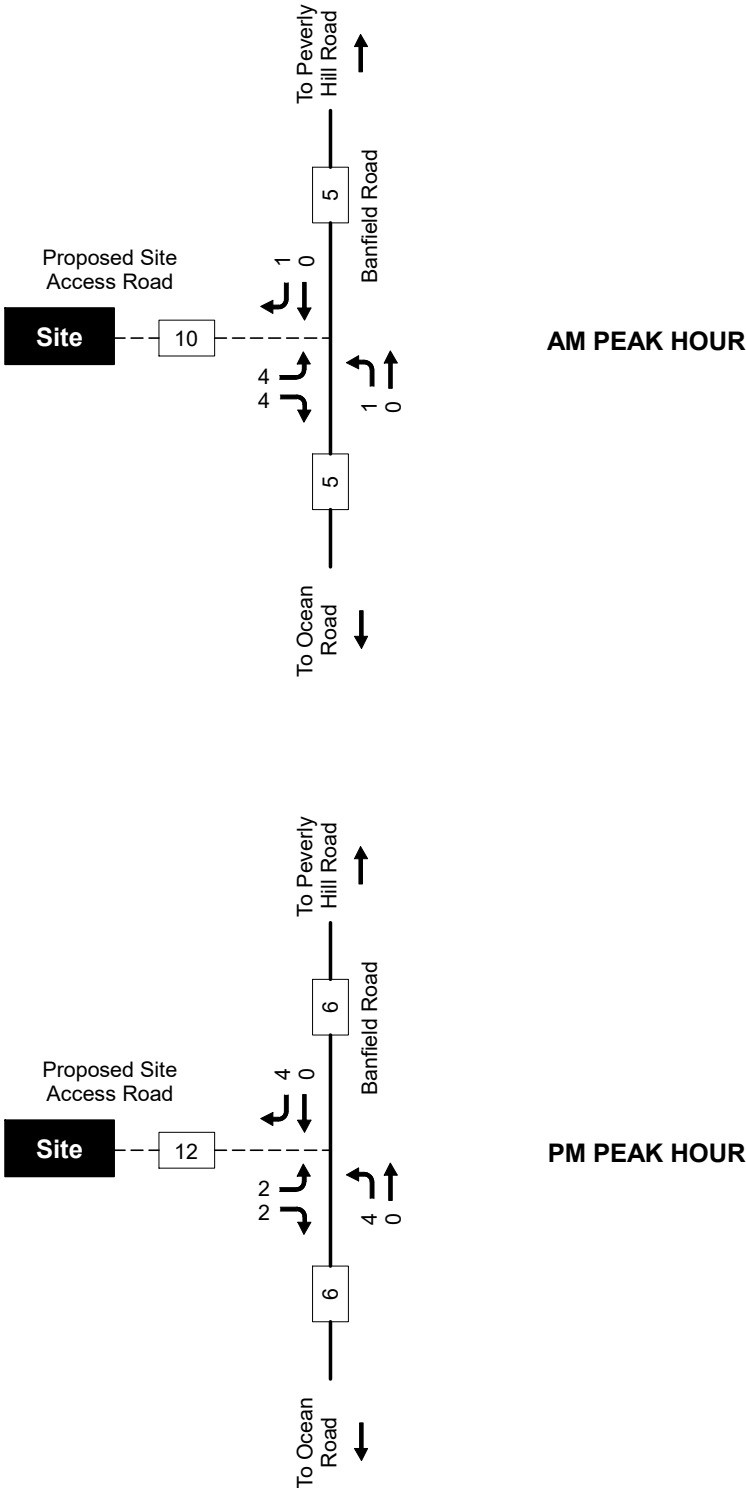

1939A

Figure 1

Site Generated Traffic Volumes
Traffic Evaluation, Proposed Residential Development, Portsmouth, New Hampshire

Findings & Conclusions

1. Access to the proposed 22-unit residential condominium development is proposed via a new two-way site access road that will extend from the west side of Banfield Road approximately midway between Peverly Hill Road and Constitution Avenue.
2. The trip generation analysis indicates that the proposed development will generate approximately 10 vehicle-trips during the weekday AM peak hour and 12 vehicle-trips during the weekday PM peak hour.
3. The trip distribution analysis indicates that approximately 50% of the site vehicles will travel to/from points north on Banfield Road, with the remainder traveling to/from points south.
4. Traffic increases of this order of magnitude will not significantly impact operations at nearby intersections. The impacts of site traffic will diminish further as drivers disperse at nearby intersections.
5. The proposed driveway intersection on Banfield Road should operate under STOP sign control (MUTCD R1-1) on the minor approach and include the installation of an 18-inch white stop line. Installation of a four-inch double yellow centerline on the site access road is considered optional, but desirable.

Attachments

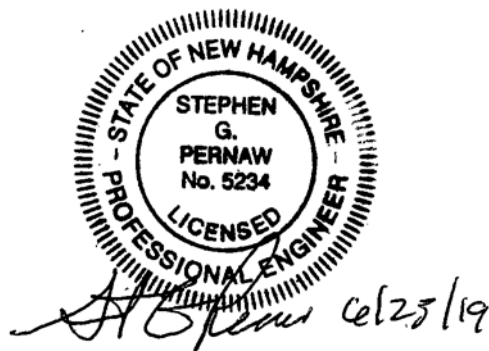

ATTACHMENTS

Trip Generation Summary

Alternative: Trip Rate Method
 Phase:
 Project: 1939A

Open Date: 5/24/2019
 Analysis Date: 5/24/2019

ITE	Land Use	Weekday Average Daily Trips			Weekday AM Peak Hour of Adjacent Street Traffic			Weekday PM Peak Hour of Adjacent Street Traffic		
		* Enter	Exit	Total	* Enter	Exit	Total	* Enter	Exit	Total
220	LOW-RISE 1	81	80	161	2	8	10	8	4	12
	22 Dwelling Units									
	Unadjusted Volume	81	80	161	2	8	10	8	4	12
	Internal Capture Trips	0	0	0	0	0	0	0	0	0
	Pass-By Trips	0	0	0	0	0	0	0	0	0
	Volume Added to Adjacent Streets	81	80	161	2	8	10	8	4	12

Total Weekday Average Daily Trips Internal Capture = 0 Percent
 Total Weekday AM Peak Hour of Adjacent Street Traffic Internal Capture = 0 Percent
 Total Weekday PM Peak Hour of Adjacent Street Traffic Internal Capture = 0 Percent

* - Custom rate used for selected time period.

Trip Generation Summary

Alternative: Trip Rate Method
 Phase:
 Project: 1939A

Open Date: 5/24/2019
 Analysis Date: 5/24/2019

ITE	Land Use	Saturday Average Daily Trips			Saturday Peak Hour of Generator			Sunday			Sunday Peak Hour of Generator				
		* Enter	Exit	Total	* Enter	Exit	Total	* Enter	Exit	Total	* Enter	Exit	Total		
220	LOW-RISE 1	90	89	179			15			69	69	138			15
	22 Dwelling Units														
	Unadjusted Volume	90	89	179	0	0	0	69	69	138	0	0	0	0	0
	Internal Capture Trips	0	0	0	0	0	0	0	0	0	0	0	0	0	0
	Pass-By Trips	0	0	0	0	0	0	0	0	0	0	0	0	0	0
	Volume Added to Adjacent Streets	90	89	179	0	0	0	69	69	138	0	0	0	0	0

Total Saturday Average Daily Trips Internal Capture = 0 Percent
 Total Saturday Peak Hour of Generator Internal Capture = 0 Percent
 Total Sunday Internal Capture = 0 Percent
 Total Sunday Peak Hour of Generator Internal Capture = 0 Percent

* - Custom rate used for selected time period.

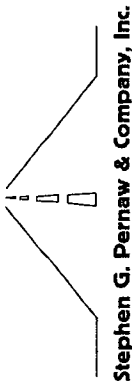

PRELIMINARY TRIP DISTRIBUTION ANALYSIS
A. Work Destination Report - Where Workers are Employed Who Live in the Selection Area - by County Subdivisions

Jobs Counts by County Subdivisions Where Workers are Employed - All Jobs	Count	Gateway %						Gateway Allocation									
		Ban N			Oce W			Ban N		Herit S		Oce W					
		A	B	C	A	B	C	A	B	A	B	C					
OUTBOUND																	
Portsmouth city (Rockingham, NH)	4,324	0.50	0.25	0.25	2162	1081	1081	4324									
Dover city (Strafford, NH)	578	1.00			578	0	0	578									
Exeter town (Rockingham, NH)	387		0.50	0.50	0	194	194	388									
Manchester city (Hillsborough, NH)	334		1.00	1.00	0	0	334	334									
Boston city (Suffolk, MA)	327		1.00	1.00	0	0	327	327									
Newington town (Rockingham, NH)	296	0.50		0.50	148	0	148	296									
Hampton town (Rockingham, NH)	288		0.90	0.10	0	259	29	288									
Durham town (Strafford, NH)	281	1.00		1.00	281	0	0	281									
Nashua city (Hillsborough, NH)	235			1.00	0	0	235	235									
Salem town (Rockingham, NH)	208			1.00	0	0	208	208									
Total All Jobs	7258				3169	1534	2556	7259									
					43.7%			21.1%			35.2%			100%			
					44		21		35								

GENERAL INFORMATION

OWNER

MAP 256 LOT 2
MAUD HETT REVOCABLE TRUST
334 HUDSON ROAD
STOWE, MA 01775

APPLICANT/PREPARED FOR

GREEN AND COMPANY REAL ESTATE
11 LAFAYETTE RD, SUITE X
NORTH HAMPTON, NH 03868

RESOURCE LIST

PLANNING/ZONING DEPARTMENT
1 JUNKINS AVE
PORTSMOUTH, NH 03801
603-610-7216
JULIET WALKER, PLANNING DIRECTOR

BUILDING DEPARTMENT

1 JUNKINS AVE
PORTSMOUTH, NH 03801
603-610-7243
ROBERT MARSILIA,
CHIEF BUILDING INSPECTOR

PUBLIC WORKS

600 PEVERLY HILL RD
PORTSMOUTH, NH 03801
603-427-1530
PETER RICE, PUBLIC WORKS DIRECTOR

POLICE DEPARTMENT

3 JUNKINS AVE
PORTSMOUTH, NH 03801
603-427-1510
ROBERT MERNER, CHIEF

FIRE DEPARTMENT

170 COURT STREET
PORTSMOUTH, NH 03801
603-427-1515
TODD GERMAIN, CHIEF

ASSOCIATED PROFESSIONALS

ENVIRONMENTAL SERVICES
GOVE ENVIRONMENTAL SERVICES
8 CONTINENTAL DRIVE
BUILDING 2 - UNIT H
EXETER, NH 03833

SOIL SCIENTIST
GOVE ENVIRONMENTAL SERVICES, INC.
8 CONTINENTAL DRIVE
BUILDING 2 - UNIT H
EXETER, NH 03833
JIM GOVE, CERTIFIED SOIL SCIENTIST

TRAFFIC ENGINEER
STEPHEN G. PERNAW
& COMPANY, INC.
PO BOX 1721
CONCORD, NH 03302
(603) 731-8500
STEPHEN G. PERNAW, PE, PTOE

SURFACE DISPOSAL SYSTEM
DESIGNER
G. R. SPAULDING DESIGN
CONSULTANTS LLC.
P.O. BOX 248
CANTERBURY, NH 03224
GARY R. SPAULDING, SSD

THE VILLAGE AT BANFIELD WOODS

BANFIELD ROAD
PORTSMOUTH, NEW HAMPSHIRE

SEPTEMBER 25, 2019
LAST REVISED MAY 5, 2020

INDEX OF SHEETS

SHEET	SHEET TITLE
C-00	COVER
P-01	PRESENTATION LANDSCAPE PLAN
C-01	NOTES & LEGEND
S-01	EXISTING CONDITIONS PLAN
S-02	TEST PIT LOGS & LEDGE PROBES
S-03	CONDOMINIUM SITE PLAN
C-02	WETLAND IMPACT PLAN
C-03	SITE PREPARATION PLAN
C-04	OVERALL SITE LAYOUT PLAN
C-07 - C-05	SITE LAYOUT PLAN
C-08	OVERALL GRADING & DRAINAGE PLAN
C-09 - C-11	GRADING & DRAINAGE PLAN
C-12	OVERALL UTILITY PLAN
C-15 - C-13	UTILITY PLAN
C-16 - C-19	LANDSCAPE PLAN
C-20A - C-20C	LIGHTING PLAN
C-21 - C-22	ROAD-A PROFILE
C-23 - C-25	EROSION CONTROL PLAN
C-26	EROSION CONTROL NOTES
C-27	WETLAND CROSSING PLAN
C-28 - C-31	FIRE TRUCK MOVEMENT PLAN
C-32 - C-43	DETAILS
REFERENCE PLANS BY ASSOCIATED PROFESSIONALS	
-	ARCHITECTURAL ELEVATION PLAN

NOTES

- SHEETS S-03, C-04 THROUGH C-07, AND C-16 THROUGH C-19 ARE TO BE RECORDED IN THE ROCKINGHAM COUNTY REGISTRY OF DEEDS.

WAIVERS

THE FOLLOWING WAIVERS FROM THE CITY OF PORTSMOUTH SITE REVIEW REGULATIONS ARE BEING REVIEWED BY THE PLANNING BOARD:

- CITY OF PORTSMOUTH SUBDIVISION RULES AND REGULATIONS SECTION VI(3)(1) - CULDESACS
"THE MAXIMUM LENGTH OF A CUL-DE-SAC SHALL GENERALLY BE FIVE HUNDRED (500) FEET UNLESS OTHERWISE APPROVED BY THE T.A.C."
- CITY OF PORTSMOUTH SITE REVIEW REGULATIONS ARTICLE 2.5.4(3)(C) - ACCESS AND CIRCULATION
USE CURRENT AASHTO TRUCK TURNING TEMPLATE DESCRIPTIONS WITH THE MINIMUM VEHICLE ALLOWED BEING A WB-50, UNLESS OTHERWISE APPROVED BY THE T.A.C.

PERMITS/APPROVALS

	NUMBER	APPROVED	EXPIRES
CITY SITE PLAN REVIEW	-	PENDING	-
TOWN SUBDIVISION APPROVAL	-	PENDING	-
NHDES SUBDIVISION APPROVAL	-	PENDING	-
NHDES ALT. OF TERRAIN	-	PENDING	-
EPA SWPPP	-	PENDING	-
NHDES WETLANDS-DREDGE & FILL	2020-00344	PENDING	-

THESE PLANS ARE PERMIT DRAWINGS ONLY AND HAVE NOT BEEN DETAILED FOR CONSTRUCTION OR BIDDING.

SITE DEVELOPMENT PLANS

TAX MAP 256 LOT 2
COVER
THE VILLAGE AT BANFIELD WOODS
PORTSMOUTH, NH
OWNED BY
WALTER D HETT TRUST
PREPARED FOR
GREEN & COMPANY REAL ESTATE

SCALE: NTS

SEPTEMBER 25, 2019

VICINITY PLAN

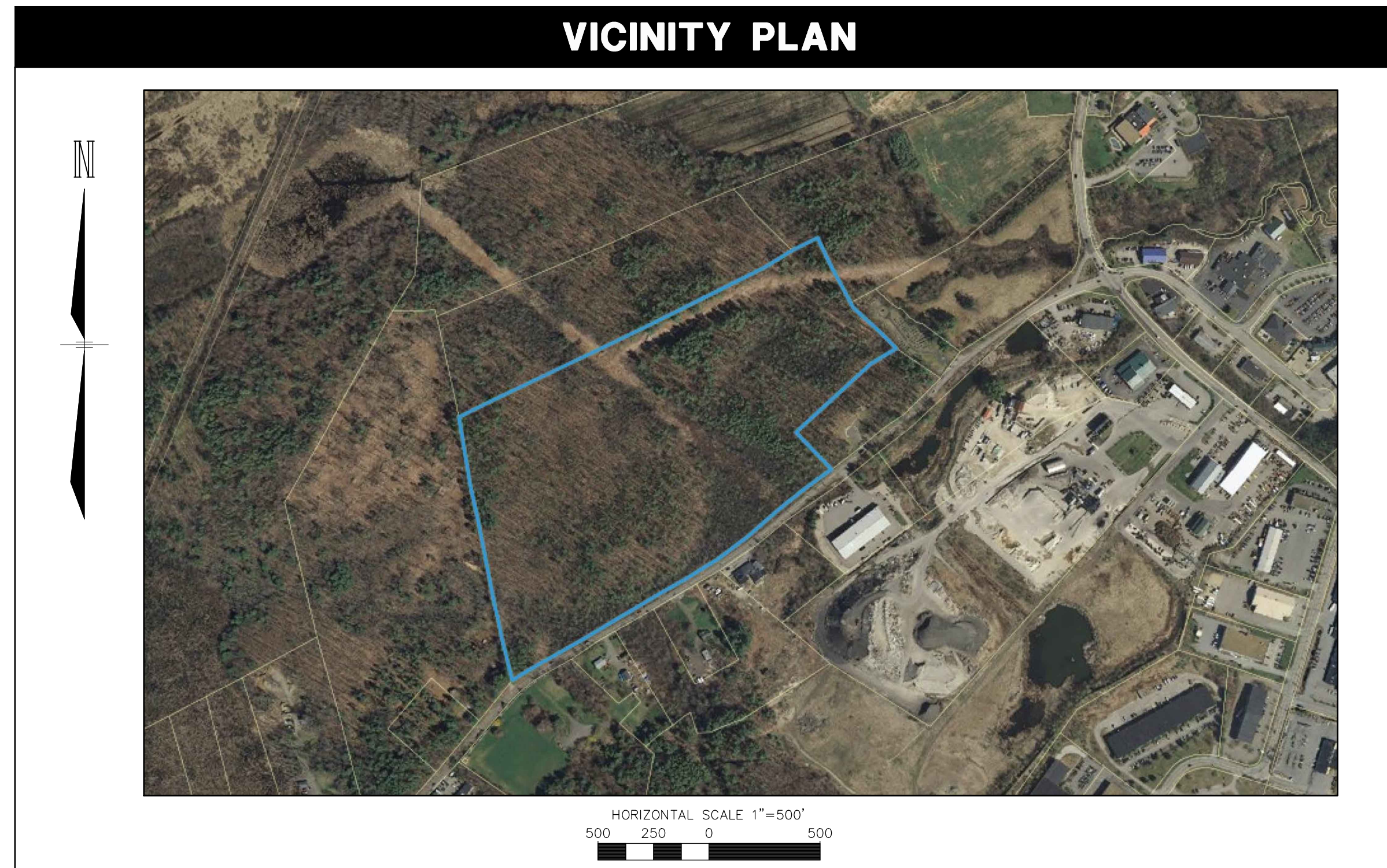

HORIZONTAL SCALE 1"=500'
500 250 0 500

ZONING MAP

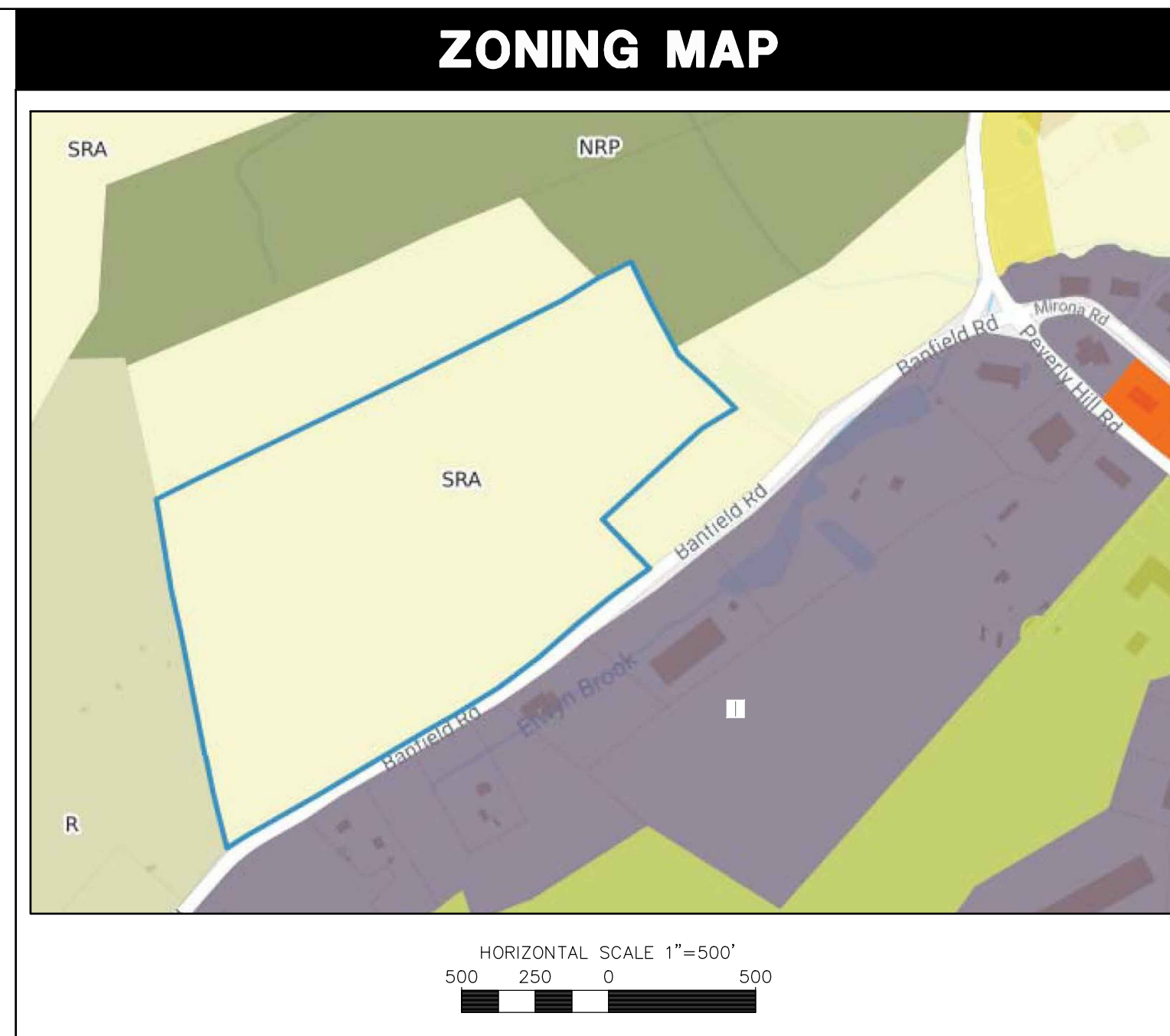

HORIZONTAL SCALE 1"=500'
500 250 0 500

REV	DATE	DESCRIPTION	DR	CK
6	5/5/2020	AoT SUBMITTAL	RCK	JJM
5	4/29/2020	REVISOR PER REGULATORY COMMENTS	RCK	JJM
4	3/20/2020	PROGRESS PRINT	RCK	JJM
3	3/4/2020	UPDATE PLANS PER REGULATORY COMMENTS	RCK	JJM
2	12/27/2019	IN HOUSE REVISIONS	RCK	JJM
1	12/23/19	REVISED PER REGULATORY COMMENTS	RCK	JJM







Copyright 2019 © Thomas F. Moran, Inc.
48 Constitution Drive, Bedford, N.H. 03110

All rights reserved. These plans and materials may not be copied, duplicated, replicated or otherwise reproduced in any form whatsoever without the prior written permission of Thomas F. Moran, Inc.

This plan is not effective unless signed by a duly authorized officer of Thomas F. Moran, Inc.

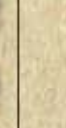

LEGEND

PROPOSED	
	LARGE DECIDUOUS SHRUBS
	SMALL DECIDUOUS SHRUBS
	LARGE EVERGREEN SHRUBS
	SMALL EVERGREEN SHRUBS
	EVERGREEN TREE
	ORNAMENTAL DECIDUOUS TREE
	MAJOR DECIDUOUS TREE

NOTE: SELECTED LANDSCAPE PLANT SPECIES TO BE NATIVE OR IMPROVED NATIVE TO NEW ENGLAND.



HORIZONTAL SCALE 1"=50'
 50 25 0 25 50

SITE DEVELOPMENT PLANS
 TAX MAP 256 LOT 2
PRELIMINARY LANDSCAPE PLAN
THE VILLAGE AT BANFIELD WOODS
PORTSMOUTH, NH
 OWNED BY
WALTER D HETT TRUST
 PREPARED FOR
GREEN & COMPANY REAL ESTATE
 SCALE: 1"=50' **APRIL 30, 2020**



48 Constitution Drive
 Bedford, NH 03110
 Phone (603) 472-4488
 Fax (603) 472-9747
 www.tfirm.com

E	47,361.00	DR	RCK	FB	LANDSCAPE	P-01
L		CK	JUN	CADFILE		

LEND

PROPOSED

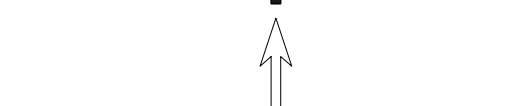
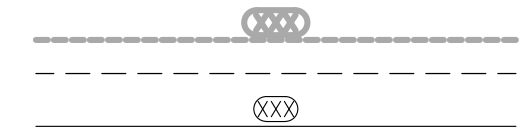
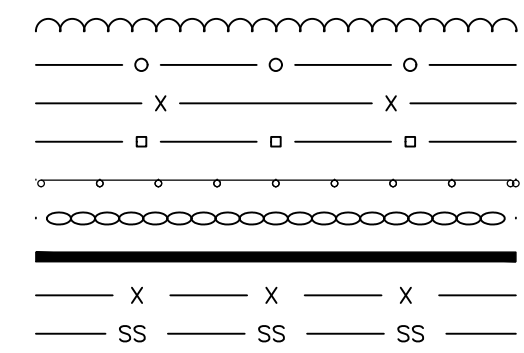
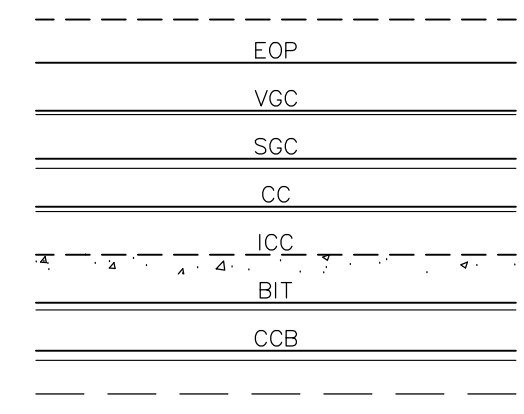
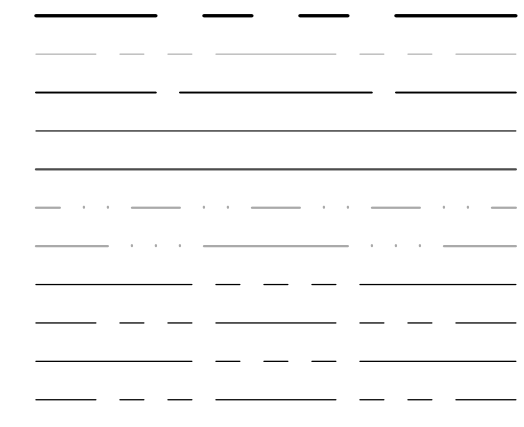

PROPOSED

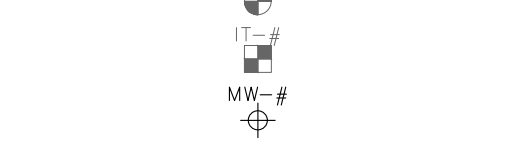
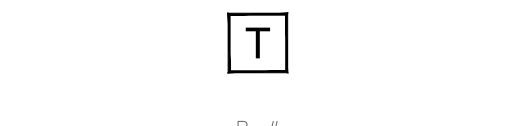
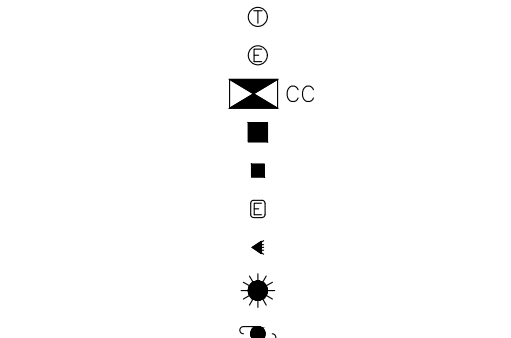
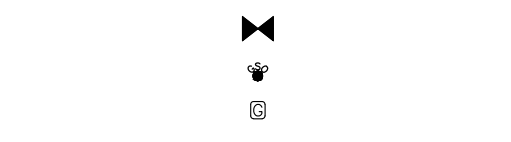
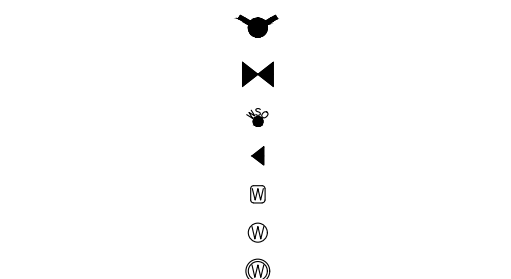
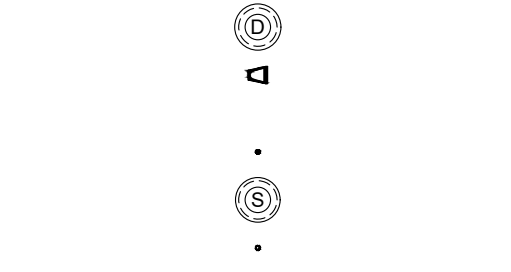
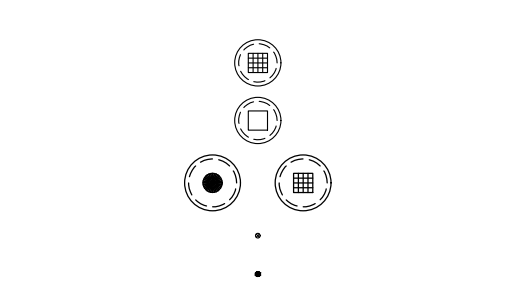
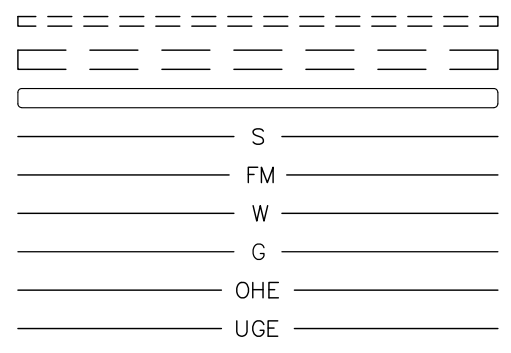
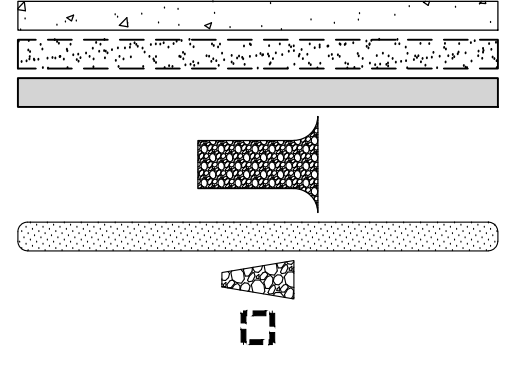

PROPERTY LINE
ZONING LINE
EASEMENT
BASELINE
FLOODPLAIN
EDGE OF WATERBODY
EDGE OF WETLAND
SETBACK (WETLAND)
SETBACK (STRUCTURE)
SETBACK (PARKING)
SETBACK (LANDSCAPE)

GRAVEL ROAD
EDGE OF PAVEMENT
VERTICAL GRANITE CURB
SLOPED GRANITE CURB
CONCRETE CURB
INTEGRATED CONCRETE CURB
BUTIMINOUS ASPHALT CURB
CAPE COD BERM
SAWCUT

BUILDING
BUILDING ROOF OVERHANG
BUILDING FOUNDATION

BUILDING ENTRANCE
OVERHEAD DOOR

TREE LINE
FENCE (CHAIN LINK)
FENCE (WIRE)
FENCE (STOCKADE)
GUARDRAIL
STONE WALL
RETAINING WALL
SILT FENCE
SILT SOCK

SOIL BOUNDARY
LIMIT OF GRADING
CONTOUR

SPOT GRADE

PARKING COUNT

YELLOW DOUBLE SOLID LINE
YELLOW SINGLE SOLID LINE

WHITE SINGLE SOLID LINE
WHITE SINGLE BROKEN LINE

STOP BAR

CROSSWALK
ACCESSIBLE PARKING SYMBOL

PAVEMENT ARROW

TRAFFIC FLOW ARROW (NOT PAINTED)

SIGN (SINGLE POST)
SIGN (DOUBLE POST)
SIGN (PYLON)
SIGN (MONUMENT)

BOLLARD
DUMPSTER PAD

CONCRETE
GRAVEL
HEAVY DUTY PAVEMENT

CONSTRUCTION ENTRANCE

SNOW STORAGE
RIPRAP

INLET PROTECTION

DRAIN LINE
DRAINAGE SWALE
STORMWATER BMP

SEWER LINE
SEWER FORCE MAIN LINE

WATER LINE
GAS LINE

OVERHEAD UTILITY LINE
UNDERGROUND UTILITY LINE

CATCH BASIN
DRAIN INLET

OUTLET CONTROL STRUCTURE

ROOF DRAIN
DRAIN CLEANOUT
DRAIN MANHOLE

FLARED END SECTION

SEWER CLEAN OUT
SEWER MANHOLE
SEWER VENT

DRAIN/SEWER/WATER PLUG OR CAP

HYDRANT
WATER GATE VALVE
WATER SHUTOFF

THRUST BLOCK
WATER METER
WATER MANHOLE
WELL

GAS GATE VALVE
GAS SHUT OFF
GAS METER

TELEPHONE MANHOLE
ELECTRIC MANHOLE

TRAFFIC CONTROL CABINET
ELECTRIC HANDHOLE
ELECTRIC PULL BOX

ELECTRIC METER
FLOOD LIGHT
LIGHT POLE
UTILITY POLE
GUY POLE

TRANSFORMER PAD

BORING LOCATION
TEST PIT LOCATION

INFILTRATION TEST LOCATION
MONITORING WELL

GENERAL NOTES

- 1. THESE PLANS ARE PERMIT DRAWINGS ONLY AND HAVE NOT BEEN DETAILED FOR CONSTRUCTION OR BIDDING.
2. THESE PLANS WERE PREPARED UNDER THE SUPERVISION OF A LICENSED PROFESSIONAL ENGINEER...
3. THE CONDOMINIUM SITE PLAN SHALL BE RECORDED IN THE ROCKINGHAM COUNTY REGISTRY OF DEEDS.
...
19. THE CONTRACTOR SHALL BE RESPONSIBLE FOR THE MEANS AND METHODS OF CONSTRUCTION AND FOR CONDITIONS AT THE SITE.

GRADING NOTES

- 1. THE CONTRACTOR SHALL ENSURE THAT ALL WORK IS PERFORMED IN ACCORDANCE WITH THE REQUIREMENTS OF NHDES ENV-WQ 1500 AS APPLICABLE.
2. THE CONTRACTOR SHALL PREPARE, MAINTAIN, AND EXECUTE A S.W.P.P. IN ACCORDANCE WITH EPA REGULATIONS AND THE CONSTRUCTION GENERAL PERMIT.
...
19. THE PROPERTY WILL BE SERVICED BY THE FOLLOWING:
DRAINAGE PRIVATE
SEWER SEPTIC SYSTEM
WATER MUNICIPAL
GAS UTILTY
ELECTRIC EVER-SOURCE
TELEPHONE CONSOLIDATED COMMUNICATIONS FKA FAIRPOINT COMMUNICATIONS
CABLE COMCAST

UTILITY NOTES

- 1. LENGTH OF PIPE IS FOR CONVENIENCE ONLY. ACTUAL PIPE LENGTH SHALL BE DETERMINED IN THE FIELD.
2. ALL PROPOSED UTILITY WORK, INCLUDING MATERIAL, INSTALLATION, TERMINATION, EXCAVATION, BEDDING, BACKFILL, COMPACTION, TESTING, CONNECTIONS, AND CONSTRUCTION SHALL BE COORDINATED WITH AND COMPLETED IN ACCORDANCE WITH THE APPROPRIATE REQUIREMENTS, CODES, AND STANDARDS OF ALL CORRESPONDING UTILITY ENTITIES AND SHALL BE THE RESPONSIBILITY OF THE CONTRACTOR.
...
19. THE PROPERTY WILL BE SERVICED BY THE FOLLOWING:
DRAINAGE PRIVATE
SEWER SEPTIC SYSTEM
WATER MUNICIPAL
GAS UTILTY
ELECTRIC EVER-SOURCE
TELEPHONE CONSOLIDATED COMMUNICATIONS FKA FAIRPOINT COMMUNICATIONS
CABLE COMCAST

ABBREVIATIONS

Table with 2 columns: Abbreviation and Full Name. Includes GENERAL and UTILITIES sections with terms like ABAN, AC, ADJ, APPROX, BC, BIT, BK/PG, BLDG, BS, BW, CONC, DIA, ELEV, EP, EXIST, etc.

SITE DEVELOPMENT PLANS

TAX MAP 256 LOT 2
NOTES & LEGEND
THE VILLAGE AT BANFIELD WOODS
PORTSMOUTH, NH

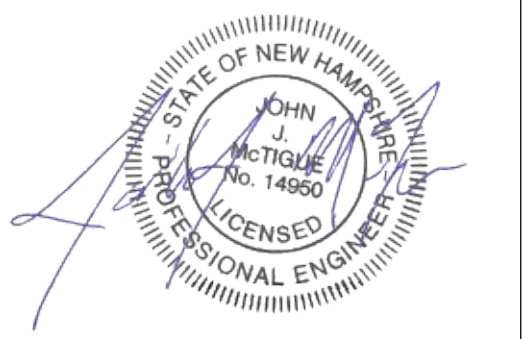

OWNED BY
WALTER D HETT TRUST
PREPARED FOR
GREEN & COMPANY REAL ESTATE

SCALE: NTS SEPTEMBER 25, 2019

Revision table with columns: REV, DATE, DESCRIPTION, DR, CK. Includes entries like 5/5/2020 Aot SUBMITTAL, 4/29/2020 REVISOR PER REGULATORY COMMENTS, etc.

Project information including TFM logo, Civil Engineers/Structural Engineers, Traffic Engineers/Landscape Architects/Scientists, 48 Constitution Drive, Bedford, NH 03110, and other contact details.

Copyright 2019 ©Thomas F. Moran, Inc. 48 Constitution Drive, Bedford, N.H. 03110. All rights reserved. This plan is not effective unless signed by a duly authorized officer of Thomas F. Moran, Inc.

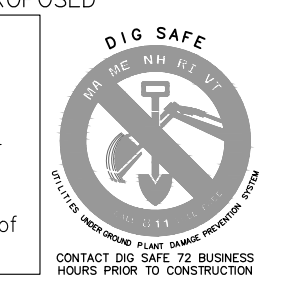

SOILS LEGEND:		
SSSS SYMBOL	SSSS MAP NAME	HYDROLOGIC SOIL GROUP
41	CHATFIELD-HOLLIS-ROCK OUTCROP COMPLEX	B
135	CHATFIELD VARIANT-NEWFIELDS COMPLEX	C
538	SQUAMSCOTT FINE SANDY LOAM	C
656	RIDGEBURY FINE SANDY LOAM	C

SOILS LEGEND:		
SLOPE PHASE:	ALPHA	SLOPE SYMBOL
0-8%	B	
8-15%	C	
15-25%	D	
25%+	E	

MAP 256 LOT 3
N/F
SHIRLEY N. GARRETT REV
TRUST 2000
BARBERRY LANE
PORTSMOUTH, NH 03801
RCRD BK # 4298 PG. # 2633

LINE	BEARING	DISTANCE
L1	N 14°03'49" W	163.61'
L2	N 62°46'56" E	140.17'
L3	N 60°47'10" E	174.31'
L4	N 61°20'44" E	105.56'
L5	N 60°58'42" E	115.75'
L6	S 40°08'01" W	22.98'
L7	S 48°30'23" E	159.80'
L8	S 45°44'06" E	110.28'
L9	S 58°19'16" W	135.27'
L10	S 53°23'55" W	154.49'
L11	S 51°24'17" W	145.51'
L12	S 48°41'16" W	83.08'
L13	S 48°05'39" W	99.00'
L14	S 52°42'36" W	173.00'
L15	S 57°03'44" W	173.81'
L16	S 62°20'11" W	108.27'
L17	S 57°50'14" W	143.89'
L18	S 59°00'53" W	162.66'
L19	S 60°14'59" W	117.96'
L20	S 59°39'51" W	113.08'
L21	S 58°23'21" W	176.30'

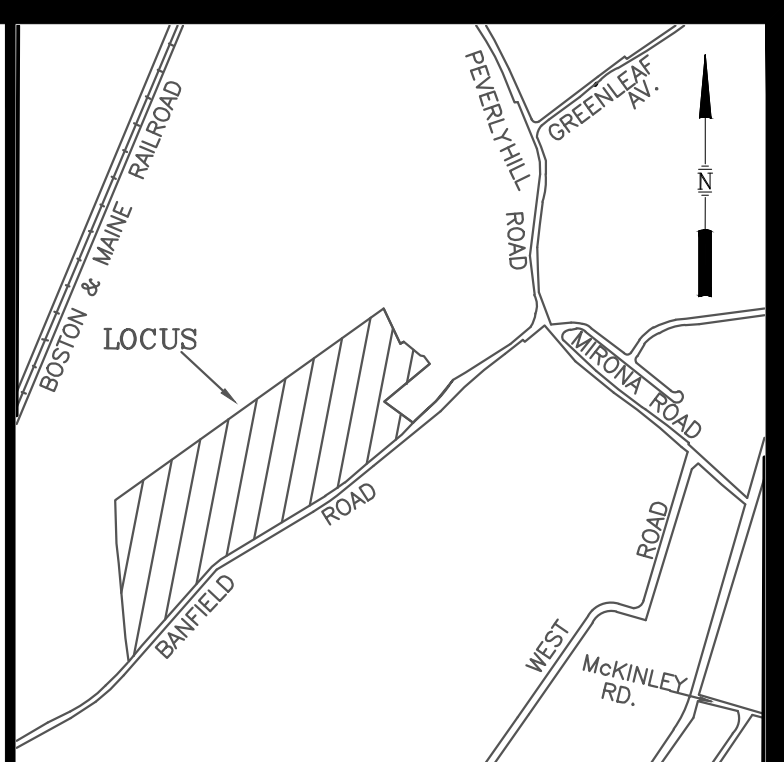

LOCATION PLAN

NOTES:

- THE PARCEL IS LOCATED IN THE SINGLE RESIDENCE A (SRA) ZONING DISTRICT.
- THE PARCEL IS SHOWN ON THE CITY OF PORTSMOUTH ASSESSOR'S MAP 256 AS LOT 2.
- THE PARCEL IS LOCATED IN ZONE X AS SHOWN ON NATIONAL FLOOD INSURANCE PROGRAM (NFIP), FLOOD INSURANCE RATE MAP (FIRM) ROCKINGHAM COUNTY, NEW HAMPSHIRE, PANEL 270 OF 681, MAP NUMBER 33015C0270E, WITH AN EFFECTIVE DATE OF MAY 17, 2005.
- DIMENSIONAL REQUIREMENTS:**
MINIMUM LOT SIZE: 1 ACRE
MINIMUM LOT AREA PER DWELLING UNIT: 1 ACRE
CONTINUOUS STREET FRONTAGE: 150'
LOT DEPTH: 200'
MINIMUM YARD DIMENSIONS:
FRONT: 30'
SIDE: 20'
REAR: 40'
MAXIMUM STRUCTURE DIMENSIONS:
STRUCTURE HEIGHT: 35'(SLOPED ROOF) 30'(FLAT ROOF)
BUILDING COVERAGE: 10%
MINIMUM OPEN SPACE: 50%
PER THE CITY OF PORTSMOUTH ZONING ORDINANCE SECTION 10.520.
- OWNER OF RECORD:
MAP 256 LOT 2:
THE WALTER D. HETT TRUST
WALTER D. HETT, TRUSTEE
334 HUDSON ROAD
STOW, MA 01775
RCRD BK.#4553 PG.#432
- PARCEL AREA:
MAP 256 LOT 2:
1,955,150 S.F.
(44.884 ACRES)
- THE INTENT OF THIS PLAN IS TO SHOW THE LOCATION OF BOUNDARIES IN ACCORDANCE WITH THE CURRENT LEGAL DESCRIPTIONS. IT IS NOT AN ATTEMPT TO DEFINE THE EXTENT OF OWNERSHIP OR DEFINE THE LIMITS OF TITLE.
- THE PURPOSE OF THIS PLAN IS TO SHOW THE BOUNDARY LINES, TOPOGRAPHY AND CURRENT SITE FEATURES OF MAP 256 LOT 2.
- A FIELD SURVEY COMPLETED BY TCE AND EJS IN MAY & JUNE 2019 USING A TOPCON DS103 AND A TOPCON FC-5000 DATA COLLECTOR.
- HORIZONTAL DATUM IS NAD83 (2011) PER STATIC GPS OBSERVATIONS. THE VERTICAL DATUM IS NAVD88 (GEOID12B) PER STATIC GPS OBSERVATIONS. THE CONTOUR INTERVAL IS 2 FEET.
- EASEMENTS, RIGHTS, AND RESTRICTIONS SHOWN OR IDENTIFIED ARE THOSE WHICH WERE FOUND DURING RESEARCH PERFORMED AT THE ROCKINGHAM COUNTY REGISTRY OF DEEDS. OTHER RIGHTS, EASEMENTS, OR RESTRICTIONS MAY EXIST WHICH A TITLE EXAMINATION OF SUBJECT PARCEL(S) WOULD DETERMINE.
- THE LOCATION OF ANY UNDERGROUND UTILITY INFORMATION SHOWN ON THIS PLAN IS APPROXIMATE. TFMORAN, INC. MAKES NO CLAIM TO THE ACCURACY OR COMPLETENESS OF UNDERGROUND UTILITIES SHOWN. PRIOR TO ANY EXCAVATION ON SITE THE CONTRACTOR SHALL CONTACT DIG SAFE.
- WETLAND DELINEATION WAS COMPLETED BY GOVE ENVIRONMENTAL SERVICES IN MAY, 2019 IN ACCORDANCE WITH THE 1987 ARMY CORP OF ENGINEERS WETLAND MANUAL AND THE 2012 REGIONAL SUPPLEMENT TO THE CORPS OF ENGINEERS WETLAND DELINEATION MANUAL: NORTHCENTRAL AND NORTHEAST REGION. FIELD LOCATED BY TFMORAN, INC.
- SEE SHEET C-02 FOR TEST PIT & LEDGE PROBE LOGS.
- SOILS NOTE:**
THIS MAP PRODUCT IS WITHIN THE TECHNICAL STANDARDS OF THE NATIONAL COOPERATIVE SOIL SURVEY. IT IS A SPECIAL PURPOSE PRODUCT, INTENDED FOR INFILTRATION REQUIREMENTS BY THE NH DES ALTERATION OF TERRAIN BUREAU. IT WAS PRODUCED BY A PROFESSIONAL SOIL SCIENTIST, AND IS NOT A PRODUCT OF THE USDA NATURAL RESOURCES CONSERVATION SERVICE. THERE IS A REPORT THAT ACCOMPANIES THIS MAP.
THE SITE SPECIFIC SOIL SURVEY (SSSS) WAS PRODUCED DECEMBER 19, 2019 AND WAS PREPARED BY JAMES P. GOVE, CSS # 004, GOVE ENVIRONMENTAL SERVICES, INC. THE SURVEY AREA IS LOCATED ON BANFIELD ROAD, PORTSMOUTH, NH.
SOILS WERE IDENTIFIED WITH THE NEW HAMPSHIRE STATE-WIDE NUMERICAL SOIL LEGEND, USDA NRCS, DURHAM, NH, ISSUE # 10, JANUARY 2011. THE NUMERIC LEGEND WAS AMENDED TO IDENTIFY THE CORRECT SOIL COMPONENTS OF THE COMPLEX.
HYDROLOGIC SOIL GROUP FROM KSAT VALUES FOR NEW HAMPSHIRE SOILS, SOCIETY OF SOIL SCIENTISTS OF NEW ENGLAND, SPECIAL PUBLICATION NO. 5, SEPTEMBER, 2009.

PLAN REFERENCES:

- "SUBDIVISION PLAN FOR WALTER D. HETT & THE TEMPLE OF ISRAEL BANFIELD ROAD COUNTY OF ROCKINGHAM PORTSMOUTH, NH", BY MILLETTE, SPRAGUE, AND COLWELL, INC. DATED JUNE 25, 1999 WITH REVISION 3 DATED 12/02/99. RCRD PLAN D-27695.
- "PROPERTY OF SWIFTWATER GIRL SCOUT COUNCIL, CITY OF PORTSMOUTH" BY JON MOORE DATED AUGUST 1972. RCRD PLAN D-3206

I CERTIFY THAT THIS SURVEY AND PLAN WERE PREPARED BY THOSE UNDER MY DIRECT SUPERVISION AND ARE THE RESULT OF A FIELD SURVEY CONDUCTED IN JUNE 2019. THIS SURVEY CONFORMS TO THE ACCURACY REQUIREMENTS OF AN URBAN SURVEY OF THE NEW HAMPSHIRE CODE OF ADMINISTRATIVE RULES OF THE BOARD OF LICENSURE FOR LAND SURVEYORS. I FURTHER CERTIFY THAT THIS SURVEY IS CORRECT TO THE BEST OF MY PROFESSIONAL KNOWLEDGE, AND THE FIELD TRAVERSE SURVEY EXCEEDS A PRECISION OF 1:15,000.

- SIGN
- UTILITY POLE W/LIGHT
- UTILITY POLE
- WATER SHUTOFF VALVE
- WATER VALVE
- BOULDER
- PROPERTY LINE
- DRAIN LINE
- EXISTING CONTOUR
- GAS LINE
- OVERHEAD UTILITY LINE
- WATER MAIN
- CHAINLINK FENCE
- STONEWALL
- TREELINE
- WETLAND SETBACK
- EDGE OF WETLAND
- SOILS LINE

- PAVEMENT
- WETLANDS
- EXPOSED LEDGE
- 100' WIDE ELECTRIC EASEMENT
- 12' RIGHT OF WAY

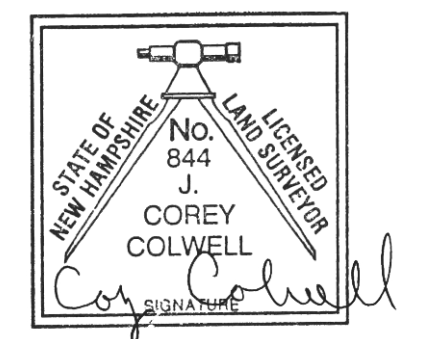
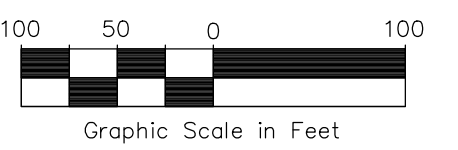

05-05-2020
DATE

LEGEND:		
ASSASSOR'S MAP NUMBER/ LOT NUMBER	DESCRIPTION	SYMBOL
AG	ABOVE GRADE	
BG	BELOW GRADE	
BK./PG.	BOOK/PAGE	
EL	ELEVATION	
ES	EVERSOURCE	
NRP	NATURAL RESOURCE PROTECTION	
I	INDUSTRIAL	
INV.	INVERT	
DI	DUCTILE IRON	
LP	LEDGE PROBE	
N/F	NOW OR FORMERLY	
PSNH	PUBLIC SERVICE COMPANY OF NEW HAMPSHIRE	
R	RURAL	
RCP	REINFORCED CONCRETE PIPE	
RCRD	ROCKINGHAM COUNTY REGISTRY OF DEEDS	
SRA	SINGLE RESIDENCE A	
S.F.	SQUARE FEET	
TBM	TEMPORARY BENCH MARK	
TP	TEST PIT	
TP	TEST PIT /LEDGE PROBE	
Q	MAIL BOX	
GW	GUY WIRE	
HYD	HYDRANT	

ASSASSOR'S MAP NUMBER/ LOT NUMBER	DESCRIPTION
MAP 256 LOT 1	N/F DENISE ARNOLD 261 BANFIELD ROAD PORTSMOUTH, NH 03801 RCRD BK. # 3644 PG. # 1763
MAP 256 LOT 2	N/F RICCI CONSTRUCTION CO INC 225 BANFIELD ROAD PORTSMOUTH, NH 03801 RCRD BK. # 2527 PG. # 0322
MAP 254 LOT 1	N/F RICCI CONSTRUCTION CO INC 225 BANFIELD ROAD PORTSMOUTH, NH 03801 RCRD BK. # 1743 PG. # 0192
MAP 256 LOT 3	N/F ANDREW R. & CAROL ANN CROTEAU 285 BANFIELD ROAD PORTSMOUTH, NH 03801 RCRD BK. # 1843 PG. # 336
MAP 266 LOT 5	N/F HOPE FOR TOMORROW FOUNDATION 1 STONERIDGE DRIVE RYE, NH 03870 RCRD BK. # 5783 PG. # 602
MAP 256 LOT 1	N/F SWIFT WATER GIRL SCOUT COUNCIL ONE COMMERCE DRIVE BEDFORD, NH 03110 RCRD BK.#2167 PG.#147 RCRD PLAN D-3206
MAP 256 LOT 2	1,955,150 S.F. (44.884 AC)
MAP 256 LOT 2-1	N/F TEMPLE OF ISRAEL 200 STATE STREET PORTSMOUTH, NH 03801 RCRD BK.#3465 PG.# 1111
MAP 256 LOT 2	N/F T. BEYAR REALTY LLC 14 LAFAYETTE ROAD-PO BOX 695 NORTH HAMPTON, NH 03842 RCRD BK.# 4004 PG.# 0763
MAP 255 LOT 1	N/F TEMPLE OF ISRAEL 200 STATE STREET PORTSMOUTH, NH 03801 RCRD BK.#4553 PG.#432
MAP 255 LOT 3	N/F WALTER D. HETT TRUST 334 HUDSON ROAD STOW, MA 01775 RCRD BK.# 553 PG.# 0436

Copyright 2020 © Thomas F. Moran, Inc. 48 Constitution Drive, Bedford, N.H. 03110
All rights reserved. These plans and materials may not be copied, duplicated, replicated or otherwise reproduced in any form whatsoever without the prior written permission of Thomas F. Moran, Inc.
This plan is not effective unless signed by a duly authorized officer of Thomas F. Moran, Inc.
MAY 05 2020 - 9:52am
W:\TFM\BEDFORD\Projects\Civil\Survey\MSC Projects\47361 - Banfield Road - Portsmouth\47361-00 - Green & Co. - Banfield Road\Survey\Drawings\47361-00 Survey.dwg



TAX MAP 256 LOT 2
EXISTING CONDITIONS PLAN
BANFIELD ROAD
PORTSMOUTH, NEW HAMPSHIRE
COUNTY OF ROCKINGHAM
OWNED BY
THE WALTER D. HETT TRUST
PREPARED FOR
GREEN & COMPANY REAL ESTATE

SCALE: 1" = 100' (22x34)
1" = 200' (11x17)

SEPTEMBER 25, 2019

Civil Engineers 170 Commerce Way, Suite 102
Structural Engineers Portsmouth, NH 03801
Traffic Engineers Phone (603) 431-2222
Land Surveyors Phone (603) 431-0910
Landscape Architects Fax (603) 431-0910
Scientists www.tfmoran.com

TFM A division of TFMoran, Inc.

DR	EJS	FB	559	
CK	BMK	CADFILE		S-01

REV.	DATE	DESCRIPTION	DR	CK
4	05/05/20	NO REVISIONS THIS SHEET	BMK	JCC
3	12/23/19	ADDED SOIL MAPPING	MVP	BMK
2	11/11/19	UPDATED WETLAND & BUFFER	MVP	BMK
1	10/2/19	ADDED TEST PIT & LEDGE PROBE LOCATIONS	MVP	BMK

CITY OF PORTSMOUTH PLANNING BOARD

CHAIRPERSON _____ DATE _____

MAP 256 LOT 3
N/F
SHIRLEY N. GARRETT TRUST
334 HUDSON ROAD
PORTSMOUTH, NH 03801
RCRD BK # 4298 PG. # 2633

MAP 255 LOT 3
N/F
WALTER D. HETT TRUST
334 HUDSON ROAD
STOW, MA 01775
RCRD BK # 4553 PG. # 0436
CONSERVATION LAND

LINE	BEARING	DISTANCE
L1	N 14°03'49" W	163.61'
L2	N 62°46'56" E	140.17'
L3	N 80°47'10" E	174.31'
L4	N 61°20'44" E	105.56'
L5	N 60°58'42" E	115.75'
L6	S 40°08'01" E	22.98'
L7	S 48°30'23" E	159.80'
L8	S 45°44'06" E	110.28'
L9	S 58°19'16" W	135.27'
L10	S 53°23'55" W	154.49'
L11	S 51°24'17" W	145.51'
L12	S 48°41'16" W	83.08'
L13	S 48°05'39" W	99.00'
L14	S 52°42'36" W	173.00'
L15	S 57°03'44" W	173.81'
L16	S 62°20'11" W	108.27'
L17	S 57°50'14" W	143.89'
L18	S 59°00'53" W	162.66'
L19	S 60°14'59" W	117.96'
L20	S 59°39'51" W	113.08'
L21	S 58°23'21" W	176.30'

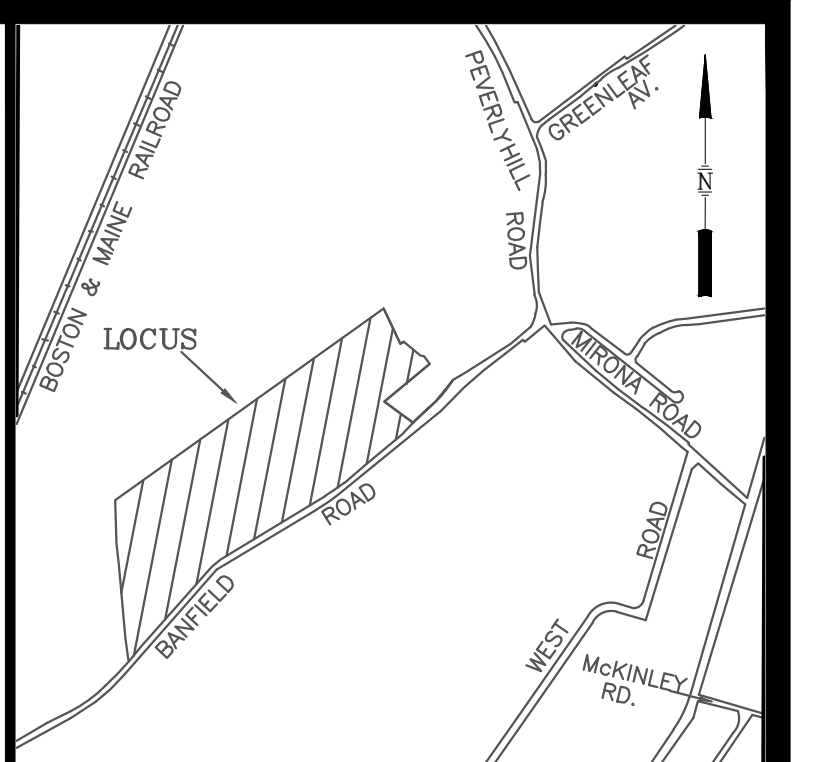

LOCATION PLAN

NOTES:

- THE PARCEL IS LOCATED IN THE SINGLE RESIDENCE A (SRA) ZONING DISTRICT.
- THE PARCEL IS SHOWN ON THE CITY OF PORTSMOUTH ASSESSOR'S MAP 256 AS LOT 2.
- THE PARCEL IS LOCATED IN ZONE X AS SHOWN ON NATIONAL FLOOD INSURANCE PROGRAM (NFIP), FLOOD INSURANCE RATE MAP (FIRM) ROCKINGHAM COUNTY, NEW HAMPSHIRE, PANEL 270 OF 681, MAP NUMBER 3301500270E, WITH AN EFFECTIVE DATE OF MAY 17, 2005.
- DIMENSIONAL REQUIREMENTS:**

REQUIRED:	PROPOSED:
MINIMUM LOT SIZE:	1 ACRE / 44.884 ACRES
LOT AREA PER DWELLING UNIT:	1 ACRE / N/A
CONTINUOUS STREET FRONTAGE:	150' / 1,730'
LOT DEPTH:	200' / 876'

MINIMUM YARD DIMENSIONS:

FRONT:	30'	254'
SIDE:	20'	53'
REAR:	40'	89.9'

MAXIMUM STRUCTURE DIMENSIONS:

STRUCTURE HEIGHT:	35' (SLOPED ROOF) / 30' (FLAT ROOF)
BUILDING COVERAGE:	10% / 2.2%
MINIMUM OPEN SPACE:	50% / 95%

PER THE CITY OF PORTSMOUTH ZONING ORDINANCE SECTION 10.520.
OPEN SPACE RESIDENTIAL PUD (OS-PUD)

REQUIRED:	PROPOSED:
MINIMUM LOT AREA:	10 ACRES / 44.884 ACRES
MINIMUM STREET FRONTAGE:	100' / 1,730'
MINIMUM EXTERNAL YARDS:	FRONT: 100' / 254'
SIDE & REAR:	50' / 53.0'; 89.9'
MINIMUM INTERNAL YARDS:	FRONT: 20' / 20.9'
SIDE & REAR:	25' / 53.0'; 89.9'
MINIMUM SEPARATION BETWEEN STRUCTURES:	30' / 31.0'
MINIMUM OPEN SPACE:	25% / 95%

PER THE CITY OF PORTSMOUTH ZONING ORDINANCE SECTION 10.725
- OWNER OF RECORD:**
MAP 256 LOT 2:
THE WALTER D. HETT TRUST
WALTER D. HETT, TRUSTEE
334 HUDSON ROAD
STOW, MA 01775
RCRD BK #4553 PG.#432
- TOTAL PARCEL AREA:**
MAP 256 LOT 2:
1,955,150 S.F. (44.884 ACRES)
SUBMITTED AREA:
1,955,150 S.F. (44.884 ACRES)
COMMON AREA:
1,955,150 S.F. (44.884 ACRES)
- THE INTENT OF THIS PLAN IS TO SHOW THE LOCATION OF BOUNDARIES IN ACCORDANCE WITH THE CURRENT LEGAL DESCRIPTIONS. IT IS NOT AN ATTEMPT TO DEFINE THE EXTENT OF OWNERSHIP OR DEFINE THE LIMITS OF TITLE.
- THE PURPOSE OF THIS PLAN IS TO DEPICT THE COMMON AREAS AND LIMITED COMMON AREAS ASSOCIATED WITH THE OPEN SPACE PLANNED UNIT DEVELOPMENT OF MAP 256 LOT 2. CONSTRUCTION OF UNITS NOT YET BEGUN, THE FINAL METES AND BOUNDS OF THE UNITS AND THEIR ASSIGNED LIMITED COMMON AREAS SHALL BE DETERMINED BY AS-BUILT PLANS WITH AN AMENDED CONDOMINIUM SITE PLAN TO BE RECORDED UPON COMPLETION OF EACH UNIT.
- THESE UNITS ARE FOR RESIDENTIAL USE ONLY.
- FIELD SURVEY COMPLETED BY TCE AND EJS IN MAY & JUNE 2019 USING A TOPCON DS103 AND A TOPCON FC-5000 DATA COLLECTOR.
- HORIZONTAL DATUM IS NAD83 (2011) PER STATIC GPS OBSERVATIONS.
- EASEMENTS, RIGHTS, AND RESTRICTIONS SHOWN OR IDENTIFIED ARE THOSE WHICH WERE FOUND DURING RESEARCH PERFORMED AT THE ROCKINGHAM COUNTY REGISTRY OF DEEDS. OTHER RIGHTS, EASEMENTS, OR RESTRICTIONS MAY EXIST WHICH A TITLE EXAMINATION OF SUBJECT PARCEL(S) WOULD DETERMINE.
- WETLAND DELINEATION WAS COMPLETED BY GOVE ENVIRONMENTAL SERVICES IN MAY, 2019 IN ACCORDANCE WITH THE 1987 ARMY CORP OF ENGINEERS WETLAND MANUAL AND THE 2012 REGIONAL SUPPLEMENT TO THE CORPS OF ENGINEERS WETLAND DELINEATION MANUAL: NORTHCENTRAL AND NORTHEAST REGION. FIELD LOCATED BY TFMORAN, INC.
- THE LOCATION OF ANY UNDERGROUND UTILITY INFORMATION SHOWN ON THIS PLAN IS APPROXIMATE. TFMORAN, INC. MAKES NO CLAIM TO THE ACCURACY OR COMPLETENESS OF UNDERGROUND UTILITIES SHOWN. PRIOR TO ANY EXCAVATION ON SITE THE CONTRACTOR SHALL CONTACT DIG SAFE.
- THE UNITS SHOWN HEREON ARE TO BE SERVED BY THE CITY OF PORTSMOUTH PUBLIC WATER SUPPLY; AN EASEMENT SHALL BE GRANTED TO THE CITY OF PORTSMOUTH TO ALLOW WATER DEPARTMENT PERSONNEL ACCESS TO VALVES, HYDRANTS AND METERS FOR LEAK DETECTION, METERING AND MAINTENANCE.

PLAN REFERENCES:

- "SUBDIVISION PLAN FOR WALTER D. HETT & THE TEMPLE OF ISRAEL BANFIELD ROAD COUNTY OF ROCKINGHAM PORTSMOUTH, NH", BY MILLETTE, SPRAGUE, AND COLWELL, INC. DATED JUNE 25, 1999 WITH REVISION 3 DATED 12/02/99. RCRD PLAN D-27695.
- "PROPERTY OF SWIFTWATER GIRL SCOUT COUNCIL, CITY OF PORTSMOUTH" BY JON MOORE DATED AUGUST 1972. RCRD PLAN D-3206

I HEREBY CERTIFY THAT THIS PLAN IS ACCURATE AND COMPLIES WITH NHRSA 356-B:20(1). ALL UNITS OR PORTIONS THEREOF DEPICTED ON ANY PORTION OF THE SUBMITTED LAND OTHER THAN WITHIN THE BOUNDARIES OF ANY CONVERTIBLE LAND HAVE NOT YET BEGUN.

I CERTIFY THAT THIS SURVEY AND PLAN WERE PREPARED BY ME OR BY THOSE UNDER MY DIRECT SUPERVISION. THIS SURVEY IS AN URBAN SURVEY AS CLASSIFIED IN THE NH CODE OF ADMINISTRATIVE RULES OF THE BOARD OF LICENSURE FOR LAND SURVEYORS. I CERTIFY THAT THIS SURVEY WAS MADE ON THE GROUND AND IS CORRECT TO THE BEST OF MY KNOWLEDGE AND BELIEF. THE TRAVERSE WAS COMPLETED BY TOTAL STATION, WITH A PRECISION GREATER THAN 1:15,000.

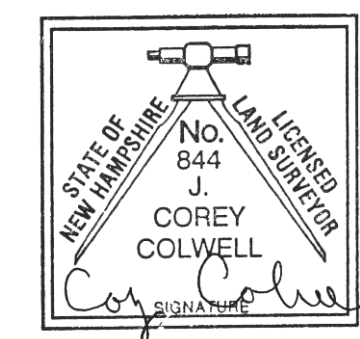

05-05-2020
DATE

TFM **MSC**
A division of TFMoran, Inc.
Civil Engineers
Structural Engineers
Traffic Engineers
Land Surveyors
Landscape Architects
Scientists
170 Commerce Way, Suite 102
Portsmouth, NH 03801
Phone (603) 431-2222
Fax (603) 431-0910
www.tfmoran.com

F	47361-00	DR	EJS	FB	559	S-03
L		CK	BMK	CADFILE		

LEGEND:

- ASSESSOR'S MAP NUMBER/LOT NUMBER
- ABOVE GRADE
- BELOW GRADE
- BOOK/PAGE
- NATURAL RESOURCE PROTECTION
- INDUSTRIAL
- LIMITED COMMON AREA
- MONUMENT TO BE SET
- NOW OR FORMERLY
- PROPOSED SEPTIC FIELD
- PLANNED UNIT DEVELOPMENT
- RURAL
- ROCKINGHAM COUNTY REGISTRY OF DEEDS
- SINGLE RESIDENCE A
- SQUARE FEET
- BOULDER
- PROPERTY LINE
- CHAINLINK FENCE
- STONEWALL
- WETLAND SETBACK
- EDGE OF WETLAND
- PAVEMENT
- WETLANDS
- COMMON OPEN SPACE
- 100' WIDE ELECTRIC EASEMENT
- 12' RIGHT OF WAY

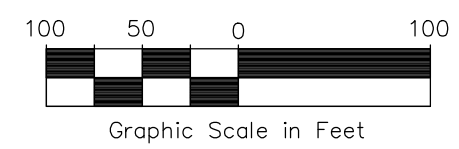

REV.	DATE	DESCRIPTION	BY	CHK
2	5/5/2020	REVISED LCA BOUNDARIES	BMK	JCC
1	3/23/2020	REVISED LCA BOUNDARIES, ADDED NOTE 15	IID	BMK
			DR	CK



CONTACT DIG SAFE 72 BUSINESS HOURS PRIOR TO CONSTRUCTION

LIMITED COMMON AREA:

LCA 1	8,233 S.F.
LCA 2	7,546 S.F.
LCA 3	10,802 S.F.
LCA 4	12,396 S.F.
LCA 5	12,587 S.F.
LCA 6	7,108 S.F.
LCA 7	13,804 S.F.
LCA 8	11,038 S.F.
LCA 9	13,443 S.F.
LCA 10	11,519 S.F.
LCA 11	15,355 S.F.
LCA 12	12,927 S.F.
LCA 13	10,714 S.F.
LCA 14	14,387 S.F.
LCA 15	18,120 S.F.
LCA 16	12,304 S.F.
LCA 17	15,553 S.F.
LCA 18	11,591 S.F.
LCA 19	7,470 S.F.
LCA 20	9,772 S.F.
LCA 21	15,200 S.F.
LCA 22	13,160 S.F.

MAP 256 LOT 1
N/F
SWIFT WATER GIRL SCOUT COUNCIL
ONE COMMERCE DRIVE
BEDFORD, NH 03110
RCRD BK #2167 PG.#147
RCRD PLAN D-3206

MAP 256 LOT 2
1,955,150 S.F.
(44.884 AC)

MAP 254 LOT 2
N/F
T. BEYAR REALTY LLC
14 LAFAYETTE ROAD-PO BOX 695
NORTH HAMPTON, NH 03842
RCRD BK # 4004 PG. # 0763

MAP 254 LOT 1
N/F
RICCI CONSTRUCTION CO INC
225 BANFIELD ROAD
PORTSMOUTH, NH 03801
RCRD BK # 1743 PG.# 0192

MAP 266 LOT 2
N/F
DENISE ARNOLD
261 BANFIELD ROAD
PORTSMOUTH, NH 03801
RCRD BK. # 3644 PG. # 1763

MAP 266 LOT 1
N/F
RICCI CONSTRUCTION CO INC
225 BANFIELD ROAD
PORTSMOUTH, NH 03801
RCRD BK. # 2527 PG. # 0322

MAP 266 LOT 1
N/F
RICCI CONSTRUCTION CO INC
225 BANFIELD ROAD
PORTSMOUTH, NH 03801
RCRD BK. # 2527 PG. # 0322

MAP 266 LOT 3
N/F
ANDREW R. & CAROL ANN CROTEAU
285 BANFIELD ROAD
PORTSMOUTH, NH 03801
RCRD BK. # 1843 PG. # 336

MAP 266 LOT 5
N/F
HOPE FOR TOMORROW FOUNDATION
1 STONERIDGE DRIVE
RYE, NH 03870
RCRD BK. # 5783 PG. # 602

TAX MAP 256 LOT 2
CONDOMINIUM SITE PLAN
BANFIELD ROAD
PORTSMOUTH, NEW HAMPSHIRE
COUNTY OF ROCKINGHAM
OWNED BY
THE WALTER D. HETT TRUST
PREPARED FOR
GREEN & COMPANY REAL ESTATE

SCALE: 1" = 100' (22x34) 1" = 200' (11x17) **DECEMBER 23, 2019**

MAP 256 LOT 3

N/F
SHIRLEY N. GARRETT REV
TRUST 2000
BARBERRY LANE
PORTSMOUTH, NH 03801
RCRD BK. # 4298 PG. # 2633

- NOTES:
1. THE PURPOSE OF THIS PLAN IS TO SHOW THE WETLAND IMPACTS AND WETLAND BUFFER IMPACTS ASSOCIATED WITH THE CONDOMINIUM DEVELOPMENT OF TAX MAP 256 LOT 2.
 2. FIELD SURVEY WAS COMPLETED BY TCE AND EJS IN MAY & JUNE 2019 USING A TOPCON DS103 AND A TOPCON FC-5000 DATA COLLECTOR.
 3. THE PURPOSE OF THE BUILDING FOOTPRINTS SHOWN ON THE PLAN ARE FOR ILLUSTRATIVE PURPOSES ONLY. FOOTPRINTS MAY CHANGE DURING CONSTRUCTION, BUT WILL REMAIN WITHIN REQUIRED SETBACKS. INDIVIDUAL GRADING PLAN ARE REQUIRED FOR EACH AREA OF HOMES TO BE DEVELOPED (PRIOR TO BUILDING PERMIT).
 4. DENSITY CALCULATIONS:
TOTAL LOT AREA: 44.88 ACRES
WETLAND AREA: 18.97 ACRES
STEEP SLOPES OVER 15%: 2.20 ACRES
TOTAL DEVELOPABLE AREA: 23.71 ACRES (REMAINING LAND IS WETLANDS AND STEEP SLOPES OVER 15%)
MAXIMUM UNITS FOR DEVELOPMENT: 23 SINGLE FAMILY HOUSES
PROPOSED UNITS FOR OPEN SPACE PLANNED UNIT DEVELOPMENT: 22 UNITS
 5. PARKING CALCULATIONS:
REQUIRED: 1.3 SPACES/UNIT PLUS ONE (1) VISITOR SPACE FOR EVERY 5 DWELLING UNITS.
TOTAL REQUIRED = 33 SPACES

PROPOSED: 88 SPACES (2 GARAGED SPACES PER UNIT, PLUS 44 SPACES ON PRIVATE DRIVEWAYS)
 6. WETLANDS DELINEATION WAS COMPLETED BY GOVE ENVIRONMENTAL SERVICES IN MAY 2019 AND FIELD LOCATED BY MSC A DIVISION OF TFMORAN, INC.
 7. STEEP SLOPE AREAS ARE APPROXIMATE. TOWN REGULATIONS DEFINE SLOPES OF 15% AND GREATER TO BE NON-BUILDABLE.
 8. EXAMINATION OF THE FLOOD INSURANCE RATE MAP FOR THE TOWN OF PORTSMOUTH, NEW HAMPSHIRE, ROCKINGHAM COUNTY, COMMUNITY PANEL NUMBER 0270, EFFECTIVE DATE: MAY 17, 2005, INDICATES THAT THE SUBJECT PARCEL IS NOT LOCATED WITHIN A FLOOD HAZARD AREA.
 9. WETLAND IMPACTS WILL REQUIRE AN APPLICATION TO NHDES WETLANDS BUREAU AND A CONDITIONAL USE PERMIT FROM THE CITY OF PORTSMOUTH. OBTAINING THESE PERMITS WILL DEPEND ON THE WETLAND FUNCTION AND VALUES, AND SENSITIVITY OF THE PROJECT.
 10. SITE DEVELOPMENT MAY REQUIRE RETAINING WALLS FOR GRADE CHANGES.
 11. PRIOR TO ANY EXCAVATION ON SITE THE CONTRACTOR SHALL CONTACT DIG SAFE AT 811.

WETLAND	WETLAND AREA	TEMPORARY WETLAND IMPACT	PERMANENT WETLAND IMPACT	BUFFER IMPACT
A	815,360 S.F.	1,135 S.F.	2,693 S.F.	10,875 S.F.
B	26,935 S.F.	0 S.F.	0 S.F.	3,515 S.F.
TOTALS	842,295 S.F.	3,828 S.F.		14,390 S.F.

LEGEND

- PERMANENT WETLAND IMPACT
- TEMPORARY WETLAND IMPACT
- PERMANENT WETLAND BUFFER IMPACT
- P- PERMANENT
- T- TEMPORARY

TAX MAP 256 LOT 2
WETLAND IMPACT PLAN
THE VILLAGE AT BANFIELD WOODS
PORTSMOUTH, NH
OWNED BY
WALTER D HETT TRUST
PREPARED FOR
GREEN & COMPANY REAL ESTATE
1"=160' (11"X17")
SCALE: 1"=80' (22"X34") **SEPTEMBER 25, 2019**

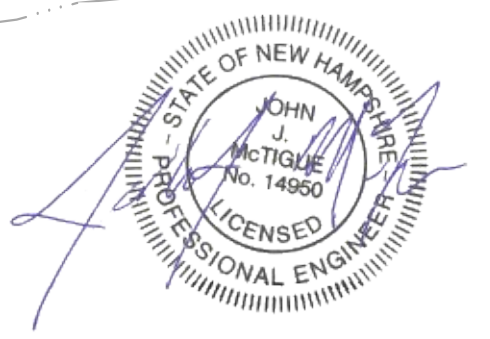

REV	DATE	DESCRIPTION	DR	CK
6	5/5/2020	AoT SUBMITTAL	RCK	JJM
5	4/29/2020	REVISOR PER REGULATORY COMMENTS	RCK	JJM
4	3/20/2020	PROGRESS PRINT	RCK	JJM
3	3/4/2020	UPDATE PLANS PER REGULATORY COMMENTS	RCK	JJM
2	12/27/2019	IN HOUSE REVISIONS	RCK	JJM
1	12/03/19	Revised Alignment Per Regulatory Comments	RCK	JJM

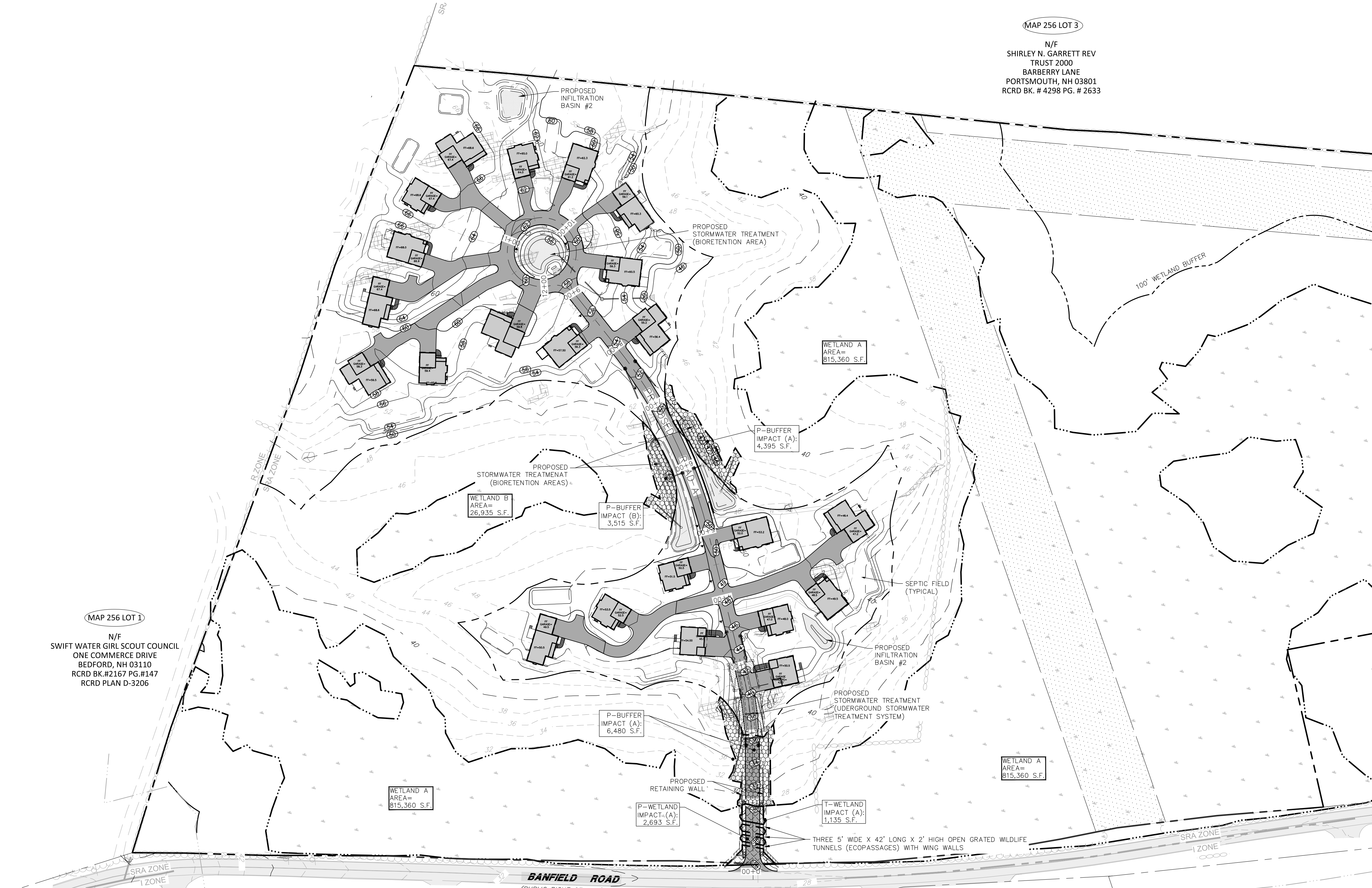
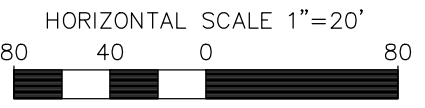

MAP 256 LOT 1
N/F
SWIFT WATER GIRL SCOUT COUNCIL
ONE COMMERCE DRIVE
BEDFORD, NH 03110
RCRD BK.#2167 PG.#147
RCRD PLAN D-3206

MAP 266 LOT 5
N/F
HOPE FOR TOMORROW FOUNDATION
1 STONERIDGE DRIVE
RYE, NH 03870
RCRD BK. # 5783 PG. # 602

MAP 266 LOT 3
N/F
ANDREW R. & CAROL ANN CROTEAU
285 BANFIELD ROAD
PORTSMOUTH, NH 03801
RCRD BK. # 1843 PG. # 336

MAP 266 LOT 1
N/F
RICCI CONSTRUCTION CO INC
225 BANFIELD ROAD
PORTSMOUTH, NH 03801
RCRD BK. # 2527 PG. # 0322

MAP 266 LOT 2
N/F
DENISE ARNOLD
261 BANFIELD ROAD
PORTSMOUTH, NH 03801
RCRD BK. # 3644 PG. # 1763

MAP 266 LOT 1
N/F
RICCI CONSTRUCTION CO INC
225 BANFIELD ROAD
PORTSMOUTH, NH 03801
RCRD BK. # 2527 PG. # 0322

MAP 254 LOT 1
N/F
RICCI CONSTRUCTION CO INC
225 BANFIELD ROAD
PORTSMOUTH, NH 03801
RCRD BK.# 1743 PG.# 0192

Copyright 2019 © Thomas F. Moran, Inc.
48 Constitution Drive, Bedford, N.H. 03110
All rights reserved. These plans and materials may not be copied, duplicated, replicated or otherwise reproduced in any form whatsoever without the prior written permission of Thomas F. Moran, Inc.
This plan is not effective unless signed by a duly authorized officer of Thomas F. Moran, Inc.



May 28, 2020 - 11:54am F:\MISC Projects\47361 - Portsmouth\47361-00 - Green & Co - Banfield Road\Design\Production Drawings\Wetland Impact.dwg

TFM Civil Engineers
Structural Engineers
Traffic Engineers
Land Surveyors
Landscape Architects
Scientists

48 Constitution Drive
Bedford, NH 03110
Phone (603) 472-4488
Fax (603) 472-9747
www.tfmoran.com

FILE: 47361.00 DR: RCK FB: -
CK: JJM CADFILE: WETLAND IMPACT C-02

May 28, 2020 - 11:54am
 F:\MISC Projects\47361 - Portsmouth\47361-00 - Green & Co - Banfield Road\Design\Production Drawings\SitePrep.dwg

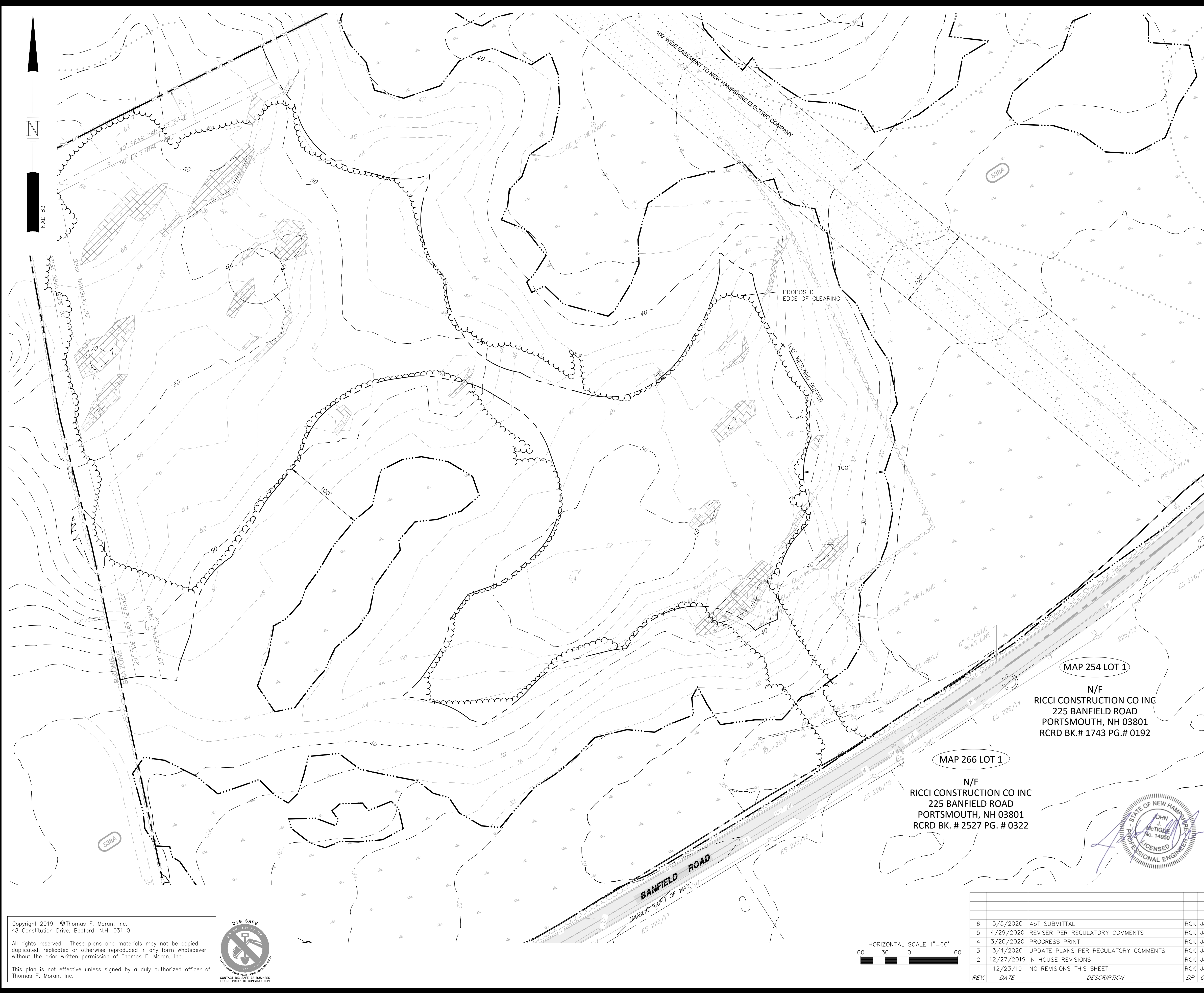

NOTES

1. THE CONTRACTOR SHALL BE RESPONSIBLE FOR VERIFYING AND DETERMINING THE LOCATIONS, SIZE, AND ELEVATIONS OF ALL EXISTING UTILITIES, SHOWN OR NOT SHOWN ON THESE PLANS PRIOR TO THE START OF ANY DEMOLITION. THE LOCATIONS SHOWN ON THESE PLANS ARE NOT GUARANTEED BY THE OWNER OR THE ENGINEER. THE ENGINEER SHALL BE NOTIFIED IN WRITING OF ANY UTILITIES INTERFERING WITH THE PROPOSED DEMOLITION TO DETERMINE APPROPRIATE ACTION TO BE TAKEN BEFORE PROCEEDING WITH THE WORK. IT IS ALSO THE CONTRACTOR'S RESPONSIBILITY TO ANTICIPATE CONFLICTS AND REPAIR EXISTING UTILITIES AS NECESSARY TO COMPLETE THE WORK AT NO ADDITIONAL COST TO THE OWNER.
2. THE CONTRACTOR SHALL MAINTAIN EMERGENCY ACCESS TO ALL AREAS AFFECTED BY WORK AT ALL TIMES.
3. EXISTING UTILITY SERVICES TO BE DISCONTINUED ARE TO BE CAPPED AS REQUIRED BY THE RESPECTIVE UTILITY COMPANIES.
4. CONSTRUCTION DEBRIS AND INVASIVE SPECIES SHALL BE REMOVED FROM SITE AND DISPOSED OF IN A LEGAL MANNER.
5. PRIOR TO THE START OF WORK, THE CONTRACTOR SHALL PLACE ORANGE CONSTRUCTION FENCING AROUND EACH TREE TO BE RETAINED, OR ADEQUATELY MARK, THROUGHOUT CONSTRUCTION. NO STOCKPILES OF MATERIAL ARE PERMITTED WITHIN THE DRIP LINE OF THE TREES TO BE SAVED.
6. CONTACT THE LANDSCAPE ARCHITECT IMMEDIATELY IF ANY TREES ARE DAMAGED DURING CONSTRUCTION.

CONSTRUCTION SEQUENCE NOTES

- TO MINIMIZE EROSION AND SEDIMENTATION DUE TO CONSTRUCTION, CONSTRUCTION SHALL FOLLOW THIS GENERAL CONSTRUCTION SEQUENCE.
- MODIFICATIONS TO THE SEQUENCE NECESSARY DUE TO THE CONTRACTOR'S SCHEDULE SHALL INCLUDE APPROPRIATE TEMPORARY AND PERMANENT EROSION AND SEDIMENTATION CONTROL MEASURES.
- THE CONTRACTOR SHALL SCHEDULE WORK SUCH THAT ANY CONSTRUCTION AREA IS STABILIZED WITHIN 45 DAYS OF INITIAL DISTURBANCE EXCEPT AS NOTED BELOW. NO MORE THAN 5 ACRES OF DISTURBED LAND SHALL BE UNSTABILIZED AT ANY ONE TIME.
- THE PROJECT SHALL BE MANAGED SO THAT IT MEETS THE REQUIREMENTS AND INTENT OF RSA 430:53 AND CHAPTER ARG 3800 RELATIVE TO INVASIVE SPECIES.
- DO NOT DISCHARGE SEDIMENT-LADEN WATERS FROM CONSTRUCTION ACTIVITIES (RUNOFF, WATER FROM EXCAVATIONS) TO THE INFILTRATION BASIN.
- DO NOT PLACE INFILTRATION SYSTEMS, BIORETENTION AREAS INTO SERVICE UNTIL THE CONTRIBUTING AREAS HAVE BEEN FULLY STABILIZED.
- AFTER THE BASIN IS EXCAVATED TO THE FINAL DESIGN ELEVATION, THE FLOOR SHOULD BE DEEPLY TILLED WITH A ROTARY TILLER OR DISC HARROW TO RESTORE THE INFILTRATION RATES, FOLLOWED BY A PASS WITH A LEVELING DRAG.
1. NOTIFY EASEMENT OWNERS PRIOR TO COMMENCEMENT OF WORK WITHIN THE RESPECTIVE EASEMENT.
 2. INSTALL ALL PERIMETER EROSION PROTECTION MEASURES AS INDICATED ON THE PLANS PRIOR TO THE COMMENCEMENT OF CONSTRUCTION.
 3. PONDS AND SWALES SHALL BE INSTALLED BEFORE ROUGH GRADING THE SITE.
 4. ALL DITCHES AND SWALES SHALL BE STABILIZED PRIOR TO DIRECTING RUNOFF TO THEM.
 5. DURING CONSTRUCTION EVERY EFFORT SHALL BE MADE TO MANAGE SURFACE RUNOFF QUALITY.
 6. DAILY, OR AS REQUIRED, CONSTRUCT TEMPORARY BERMS, DRAINS, DITCHES, SILT BARRIERS, SEDIMENT TRAPS, ETC. MULCH AND SEED AS REQUIRED. (TEMPORARY SEED MIXTURE OF WINTER RYE APPLIED AT A RATE OF 2.5 LBS/1000 SF SHALL BE USED).
 7. ALL ROADWAYS AND PARKING LOTS SHALL BE STABILIZED WITHIN 72 HOURS OF ACHIEVING FINISHED GRADE.
 8. CONDUCT MAJOR EARTHWORK, INCLUDING CLEARING AND GRUBBING, WITHIN THE LIMITS OF WORK. ALL CUT AND FILL SLOPES SHALL BE SEEDED WITHIN 72 HOURS AFTER GRADING.
 9. ALL STRIPPED TOPSOIL AND OTHER EARTH MATERIALS SHALL BE STOCKPILED OUTSIDE THE IMMEDIATE WORK AND WETLAND AREAS. A SILT BARRIER SHALL BE CONSTRUCTED AROUND THESE PILES IN A MANNER TO PROVIDE ACCESS AND AVOID SEDIMENT OUTSIDE OF THE WORK AREA.
 10. CONSTRUCT TEMPORARY CULVERTS AND DIVERSIONS (SWALES, BASINS, ETC.) AS REQUIRED.
 11. BEGIN PERMANENT AND TEMPORARY INSTALLATION OF SEED AND MULCH.
 12. PERFORM EARTHWORK NECESSARY TO ESTABLISH ROUGH GRADING AROUND PROPOSED ROAD AND ACCESS DRIVES. MANAGE EXPOSED SOIL SURFACES TO AVOID TRANSPORTING SEDIMENTS INTO WETLANDS.
 13. INSTALL SUBSURFACE UTILITIES (WATER, SEWER, GAS, ELECTRIC, COMMUNICATIONS, DRAINAGE, DRAINAGE FACILITIES, ETC.).
 14. CONSTRUCT PROPOSED ROADWAY, RAIN GARDENS, BIORETENTION AREAS AND DRAINAGE SWALES. ALL DITCHES, SWALES SHALL BE FULLY STABILIZED PRIOR TO DIRECTING FLOW TO THEM.
 15. COMPLETE BUILDINGS, BIORETENTION AREAS, AND LOAM AND SEED UNSTABLE AREAS.
 16. COMPLETE SEEDING AND MULCHING. SEED TO BE APPLIED WITH BROADCAST SPREADER OR BY HYDRO-SEEDING, THEN ROLLED, RAKED OR DRAGGED TO ASSURE SEED/SOIL CONTACT.
 17. REMOVE TEMPORARY EROSION CONTROL MEASURES AFTER SEEDED AREAS HAVE BECOME FIRMLY ESTABLISHED AND SITE IMPROVEMENTS ARE COMPLETE.
 18. DURING THE COURSE OF THE WORK AND UPON COMPLETION, THE CONTRACTOR SHALL REMOVE ALL SEDIMENT DEPOSITS, EITHER ON OR OFF SITE, INCLUDING CATCH BASINS, AND SUMPS, DRAIN PIPES AND DITCHES, CURB LINES, ALONG SILT BARRIERS, ETC. RESULTING FROM SOIL AND/OR CONSTRUCTION OPERATIONS.
 19. SEE WINTER CONSTRUCTION SEQUENCE ON EROSION CONTROL NOTES SHEET FOR WORK CONDUCTED AFTER OCTOBER 15TH.

MAP 254 LOT 1
 N/F
 RICCI CONSTRUCTION CO INC
 225 BANFIELD ROAD
 PORTSMOUTH, NH 03801
 RCRD BK.# 1743 PG.# 0192

MAP 266 LOT 1
 N/F
 RICCI CONSTRUCTION CO INC
 225 BANFIELD ROAD
 PORTSMOUTH, NH 03801
 RCRD BK. # 2527 PG. # 0322

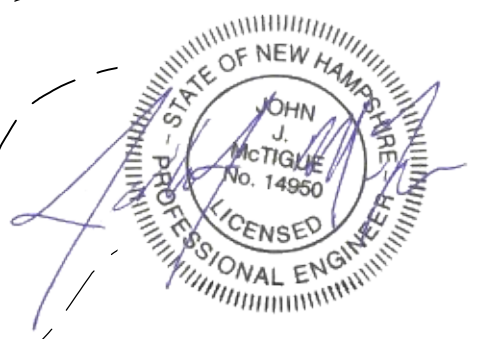

SITE DEVELOPMENT PLANS

TAX MAP 256 LOT 2
SITE PREPARATION PLAN
THE VILLAGE AT BANFIELD WOODS
PORTSMOUTH, NH

OWNED BY
WALTER D HETT TRUST
 PREPARED FOR
GREEN & COMPANY REAL ESTATE
 1"=120' (11"X17")
 SCALE: 1"=60' (22"X34") **SEPTEMBER 25, 2019**

Copyright 2019 © Thomas F. Moran, Inc.
 48 Constitution Drive, Bedford, N.H. 03110
 All rights reserved. These plans and materials may not be copied, duplicated, replicated or otherwise reproduced in any form whatsoever without the prior written permission of Thomas F. Moran, Inc.
 This plan is not effective unless signed by a duly authorized officer of Thomas F. Moran, Inc.

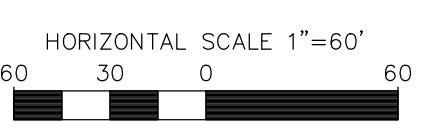

REV	DATE	DESCRIPTION	DR	CK
6	5/5/2020	AoT SUBMITTAL	RCK	JJM
5	4/29/2020	REVISER PER REGULATORY COMMENTS	RCK	JJM
4	3/20/2020	PROGRESS PRINT	RCK	JJM
3	3/4/2020	UPDATE PLANS PER REGULATORY COMMENTS	RCK	JJM
2	12/27/2019	IN HOUSE REVISIONS	RCK	JJM
1	12/23/19	NO REVISIONS THIS SHEET	RCK	JJM

	Civil Engineers Structural Engineers Traffic Engineers Land Surveyors Landscape Architects Scientists	48 Constitution Drive Bedford, NH 03110 Phone (603) 472-4488 Fax (603) 472-9747 www.tfmoran.com
	F I L E 47361.00 DR RCK FB CK JUM CADFILE SITEPREP	C-03



MAP 256 LOT 3

N/F
SHIRLEY N. GARRETT REV
TRUST 2000
BARBERRY LANE
PORTSMOUTH, NH 03801
RCRD BK. # 4298 PG. # 2633

SITE DATA

OWNER OF RECORD OF MAP 256 LOT 02: HETT MAUD REVOCABLE TRUST,
334 HUDSON ROAD, STOW, MA 01775
DEED REFERENCE TO PARCEL 15 BK 4553 PG 0432
AREA OF PARCEL = 1,955,150± SF OR 44.88± ACRES

ZONED: SINGLE RESIDENCE A (SRA)
EXISTING USE: N/A
PROPOSED USE: SINGLE FAMILY CONDOMINIUM UNITS

THE PURPOSE OF THIS PLAN IS TO DEPICT A DEVELOPMENT OF 22 SINGLE FAMILY CONDOMINIUM UNITS WITH ASSOCIATED ROADWAY, UTILITIES, AND SITE IMPROVEMENTS.

DENSITY CALCULATIONS:
TOTAL LOT AREA: 44.88 ACRES
WETLAND AREA: 18.97 ACRES
STEEP SLOPES OVER 15%: 2.20 ACRES
TOTAL DEVELOPABLE AREA: 23.71 ACRES (REMAINING LAND IS WETLANDS AND STEEP SLOPES OVER 15%)
MAXIMUM UNITS FOR DEVELOPMENT: 23 SINGLE FAMILY HOUSES
PROPOSED UNITS FOR OPEN SPACE PLANNED UNIT DEVELOPMENT: 22 THREE (3) BEDROOM UNITS

PARKING CALCULATIONS:
REQUIRED: 1.3 SPACES/UNIT PLUS ONE (1) VISITOR SPACE FOR EVERY 5 DWELLING UNITS.
TOTAL REQUIRED = 33 SPACES

PROPOSED: 88 SPACES (2 GARAGED SPACES PER UNIT, PLUS 44 SPACES ON PRIVATE DRIVEWAYS)

EFFECTIVE IMPERVIOUS SURFACE CALCULATIONS:
IMPERVIOUS AREA/TOTAL LOT AREA = 101,920 SF/1,955,150 SF = 0.0521
TOTAL EFFECTIVE IMPERVIOUS SURFACE = 5.21%

NOTES

1. ALL DIMENSIONS ARE TO THE FACE OF CURB UNLESS NOTED OTHERWISE.
2. SEE GENERAL NOTES ON NOTES & LEGEND SHEET (C-01).
3. LIGHTING, SIGNAGE, LANDSCAPING, AND SCREENING SHALL MEET THE REQUIREMENTS OF THE CITY ZONING ORDINANCE AND SITE PLAN REGULATIONS.
4. ALL CONDITIONS ON THIS PLAN SHALL REMAIN IN EFFECT IN PERPETUITY PURSUANT TO THE REQUIREMENTS OF THE SITE PLAN REVIEW REGULATIONS.
5. THE THREE FOOT PANEL ALONG THE EDGE OF THE ROADWAY TO BE USED FOR SNOW STORAGE.
6. THIS SITE PLAN SHALL BE RECORDED IN THE ROCKINGHAM COUNTY REGISTRY OF DEEDS.
7. ALL IMPROVEMENTS SHOWN ON THIS SITE PLAN SHALL BE CONSTRUCTED AND MAINTAINED IN ACCORDANCE WITH THE PLAN BY THE PROPERTY OWNER AND ALL FUTURE PROPERTY OWNERS. NO CHANGED SHALL BE MADE TO THIS SITE PLAN WITHOUT THE EXPRESS APPROVAL OF THE PORTSMOUTH PLANNING DIRECTOR.

SIGN LEGEND

ID	SIGN	SIZE (INCHES)		DESIGN (COLORING, TEXT SIZE, SPACING, SHAPE, RETROFLECTIVITY, ETC.)	NO. OF SIGNS
		WIDTH	HEIGHT		
R1-1		30	30	REFER TO THE 2009 MANUAL ON UNIFORM TRAFFIC CONTROL DEVICES (MUTCD) FOR STREETS AND HIGHWAYS	1
R713		12	18	REFER TO THE 2009 MANUAL ON UNIFORM TRAFFIC CONTROL DEVICES (MUTCD) FOR STREETS AND HIGHWAYS	17

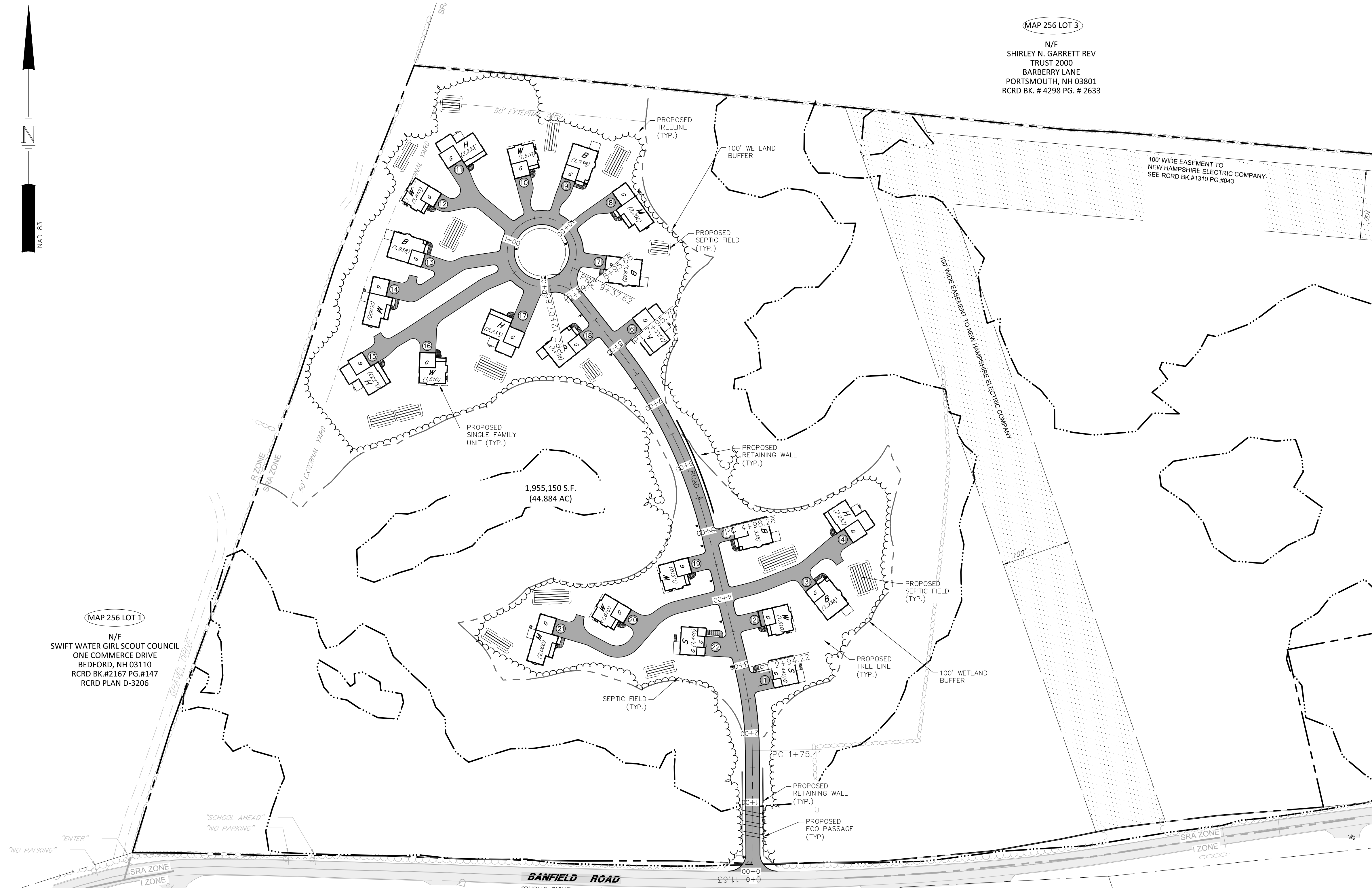

MAP 256 LOT 1
N/F
SWIFT WATER GIRL SCOUT COUNCIL
ONE COMMERCE DRIVE
BEDFORD, NH 03110
RCRD BK.#2167 PG.#147
RCRD PLAN D-3206

MAP 266 LOT 5
N/F
HOPE FOR TOMORROW FOUNDATION
1 STONERIDGE DRIVE
RYE, NH 03870
RCRD BK. # 5783 PG. # 602

MAP 266 LOT 3
N/F
ANDREW R. & CAROL ANN CROTEAU
285 BANFIELD ROAD
PORTSMOUTH, NH 03801
RCRD BK. # 1843 PG. # 336

MAP 266 LOT 1
N/F
RICCI CONSTRUCTION CO INC
225 BANFIELD ROAD
PORTSMOUTH, NH 03801
RCRD BK. # 2527 PG. # 0322

MAP 266 LOT 2
N/F
DENISE ARNOLD
261 BANFIELD ROAD
PORTSMOUTH, NH 03801
RCRD BK. # 3644 PG. # 1763

MAP 266 LOT 1
N/F
RICCI CONSTRUCTION CO INC
225 BANFIELD ROAD
PORTSMOUTH, NH 03801
RCRD BK. # 2527 PG. # 0322

MAP 254 LOT 1
N/F
RICCI CONSTRUCTION CO INC
225 BANFIELD ROAD
PORTSMOUTH, NH 03801
RCRD BK.# 1743 PG.# 0192

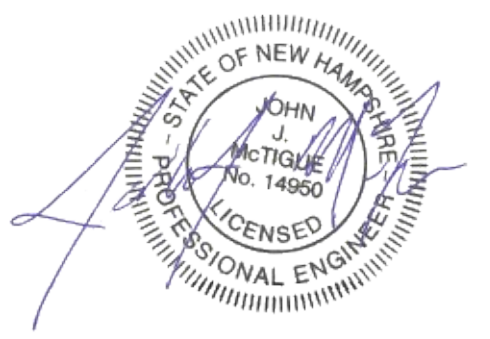

SITE DEVELOPMENT PLANS

TAX MAP 256 LOT 2
OVERALL SITE LAYOUT PLAN
THE VILLAGE AT BANFIELD WOODS
PORTSMOUTH, NH

OWNED BY
WALTER D HETT TRUST
PREPARED FOR
GREEN & COMPANY REAL ESTATE

1"=160' (11"X17")
SCALE: 1"=80' (22"X34") **SEPTEMBER 25, 2019**



Civil Engineers
Structural Engineers
Traffic Engineers
Land Surveyors
Landscape Architects
Scientists

48 Constitution Drive
Bedford, NH 03110
Phone (603) 472-4488
Fax (603) 472-9747
www.tfmoran.com

REV	DATE	DESCRIPTION	DR	CK
6	5/5/2020	AoT SUBMITTAL	RCK	JJM
5	4/29/2020	REVISER PER REGULATORY COMMENTS	RCK	JJM
4	3/20/2020	PROGRESS PRINT	RCK	JJM
3	3/4/2020	UPDATE PLANS PER REGULATORY COMMENTS	RCK	JJM
2	12/27/2019	IN HOUSE REVISIONS	RCK	JJM
1	12/23/19	NO REVISIONS THIS SHEET	RCK	JJM

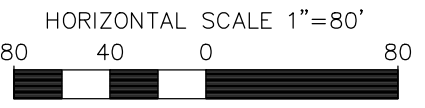

Copyright 2019 © Thomas F. Moran, Inc.
48 Constitution Drive, Bedford, N.H. 03110
All rights reserved. These plans and materials may not be copied, duplicated, replicated or otherwise reproduced in any form whatsoever without the prior written permission of Thomas F. Moran, Inc.
This plan is not effective unless signed by a duly authorized officer of Thomas F. Moran, Inc.



May 28, 2020 - 11:56am F:\MISC Projects\47361 - Portsmouth\47361-00 - Green & Co - Banfield Road\Design\Production Drawings\SiteLayout.dwg

May 28, 2020 - 11:56am F:\MSC Projects\47381 - Portsmouth\47381-00 - Green & Co - Banfield Road\Design\Production Drawings\SiteLayout.dwg

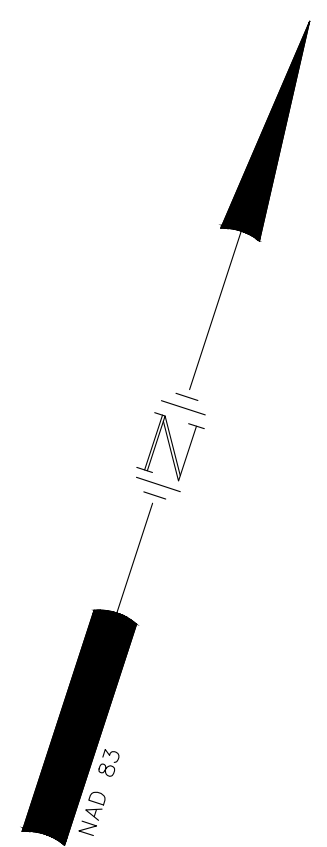
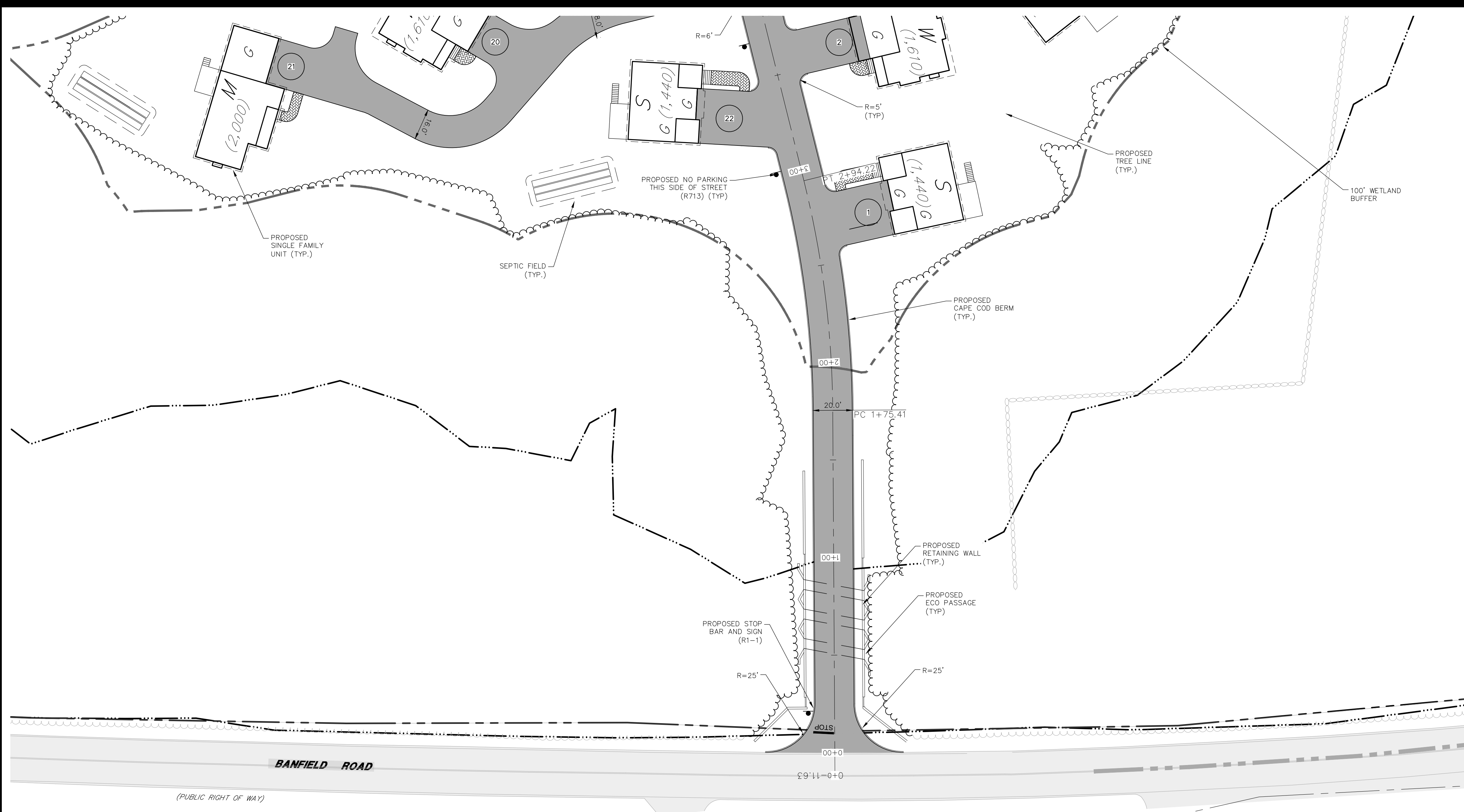

NOTES

1. THIS SITE PLAN SHALL BE RECORDED IN THE ROCKINGHAM COUNTY REGISTRY OF DEEDS.
2. ALL IMPROVEMENTS SHOWN ON THIS SITE PLAN SHALL BE CONSTRUCTED AND MAINTAINED IN ACCORDANCE WITH THE PLAN BY THE PROPERTY OWNER AND ALL FUTURE PROPERTY OWNERS. NO CHANGED SHALL BE MADE TO THIS SITE PLAN WITHOUT THE EXPRESS APPROVAL OF THE PORTSMOUTH PLANNING DIRECTOR.

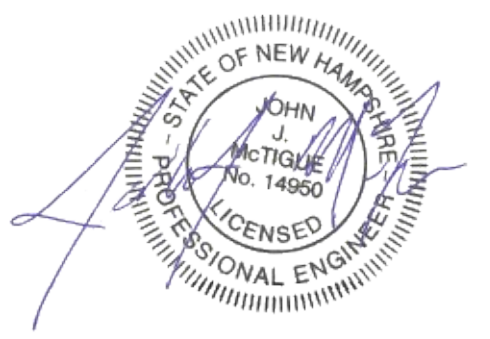

SITE DEVELOPMENT PLANS

TAX MAP 256 LOT 2
SITE LAYOUT PLAN
THE VILLAGE AT BANFIELD WOODS
PORTSMOUTH, NH
 OWNED BY
WALTER D HETT TRUST
 PREPARED FOR
GREEN & COMPANY REAL ESTATE
1"=60' (11"X17")
SCALE: 1"=30' (22"X34") **SEPTEMBER 25, 2019**

Copyright 2019 © Thomas F. Moran, Inc.
 48 Constitution Drive, Bedford, N.H. 03110
 All rights reserved. These plans and materials may not be copied, duplicated, replicated or otherwise reproduced in any form whatsoever without the prior written permission of Thomas F. Moran, Inc.
 This plan is not effective unless signed by a duly authorized officer of Thomas F. Moran, Inc.

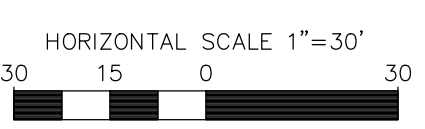

REV	DATE	DESCRIPTION	DR	CK
6	5/5/2020	AoT SUBMITTAL	RCK	JJM
5	4/29/2020	REVISOR PER REGULATORY COMMENTS	RCK	JJM
4	3/20/2020	PROGRESS PRINT	RCK	JJM
3	3/4/2020	UPDATE PLANS PER REGULATORY COMMENTS	RCK	JJM
2	12/27/2019	IN HOUSE REVISIONS	RCK	JJM
1	12/23/19	NO REVISIONS THIS SHEET	RCK	JJM

	Civil Engineers Structural Engineers Traffic Engineers Land Surveyors Landscape Architects Scientists			48 Constitution Drive Bedford, NH 03110 Phone (603) 472-4488 Fax (603) 472-9747 www.tfmoran.com
	47361.00	DR RCK CK JUM	FB CADFILE	
				C-05

May 28, 2020 - 11:56am
F:\MISC Projects\47381 - Banfield Road - Portsmouth\47381-00 - Green & Co - Banfield Road\Design\Production Drawings\SiteLayout.dwg

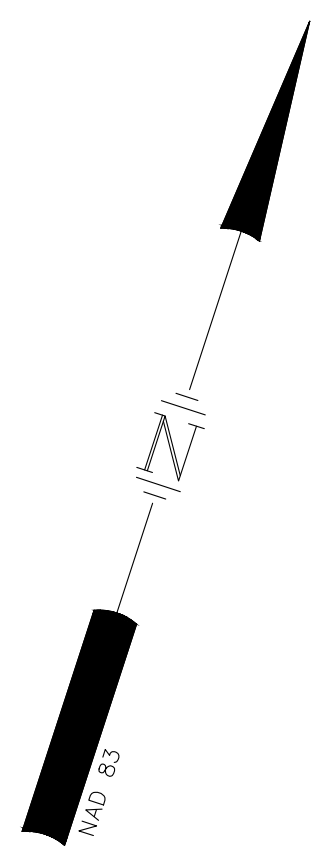
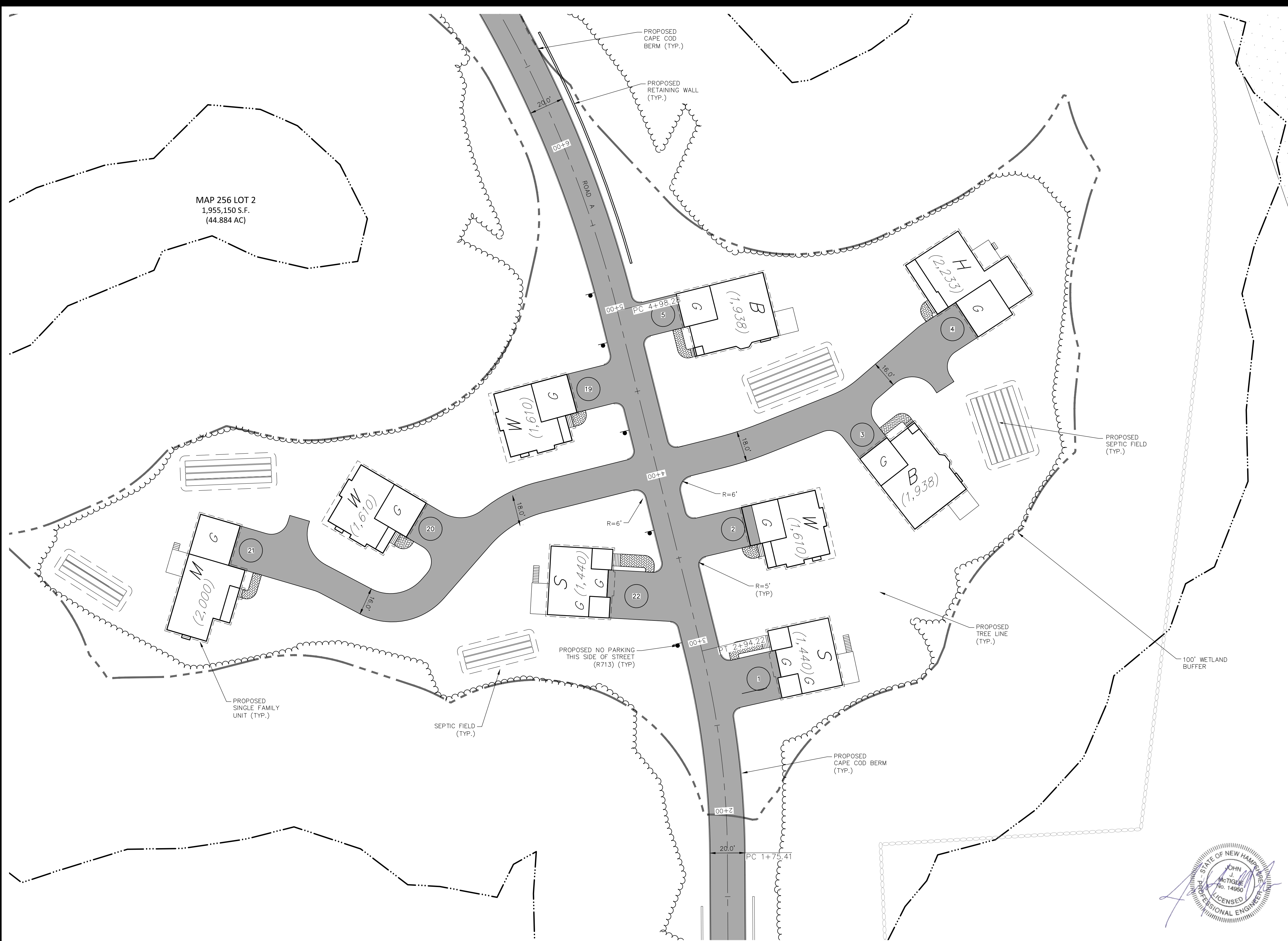

NOTES

1. THIS SITE PLAN SHALL BE RECORDED IN THE ROCKINGHAM COUNTY REGISTRY OF DEEDS.
2. ALL IMPROVEMENTS SHOWN ON THIS SITE PLAN SHALL BE CONSTRUCTED AND MAINTAINED IN ACCORDANCE WITH THE PLAN BY THE PROPERTY OWNER AND ALL FUTURE PROPERTY OWNERS. NO CHANGED SHALL BE MADE TO THIS SITE PLAN WITHOUT THE EXPRESS APPROVAL OF THE PORTSMOUTH PLANNING DIRECTOR.

SITE DEVELOPMENT PLANS

TAX MAP 256 LOT 2
SITE LAYOUT PLAN
THE VILLAGE AT BANFIELD WOODS
PORTSMOUTH, NH

OWNED BY
WALTER D HETT TRUST
PREPARED FOR
GREEN & COMPANY REAL ESTATE
1"=60' (11"X17")

SCALE: 1"=30' (22"X34") **SEPTEMBER 25, 2019**

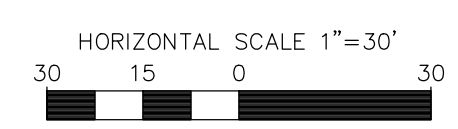
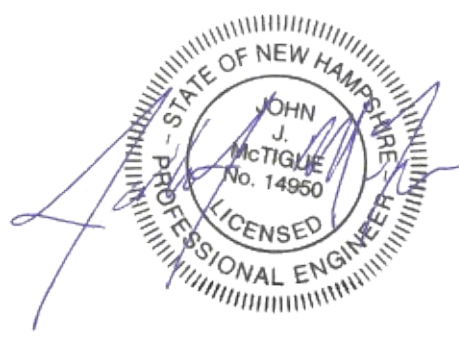

Copyright 2019 © Thomas F. Moran, Inc.
48 Constitution Drive, Bedford, N.H. 03110

All rights reserved. These plans and materials may not be copied, duplicated, replicated or otherwise reproduced in any form whatsoever without the prior written permission of Thomas F. Moran, Inc.

This plan is not effective unless signed by a duly authorized officer of Thomas F. Moran, Inc.



REV	DATE	DESCRIPTION	DR	CK
6	5/5/2020	AoT SUBMITTAL	RCK	JJM
5	4/29/2020	REVISOR PER REGULATORY COMMENTS	RCK	JJM
4	3/20/2020	PROGRESS PRINT	RCK	JJM
3	3/4/2020	UPDATE PLANS PER REGULATORY COMMENTS	RCK	JJM
2	12/27/2019	IN HOUSE REVISIONS	RCK	JJM
1	12/23/19	NO REVISIONS THIS SHEET	RCK	JJM

Civil Engineers
Structural Engineers
Traffic Engineers
Land Surveyors
Landscape Architects
Scientists

48 Constitution Drive
Bedford, NH 03110
Phone (603) 472-4488
Fax (603) 472-9747
www.tfmoran.com

47361.00	DR RCK	FB	-				
	CK JJM	CADFILE	SITELAYOUT				C-06

May 28, 2020 - 11:56am
F:\MISC Projects\47361 - Portsmouth\47361-00 - Green & Co - Banfield Road\Design\Production Drawings\SiteLayout.dwg

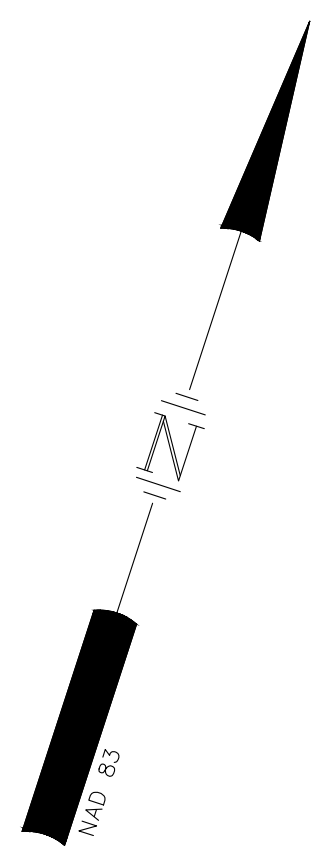
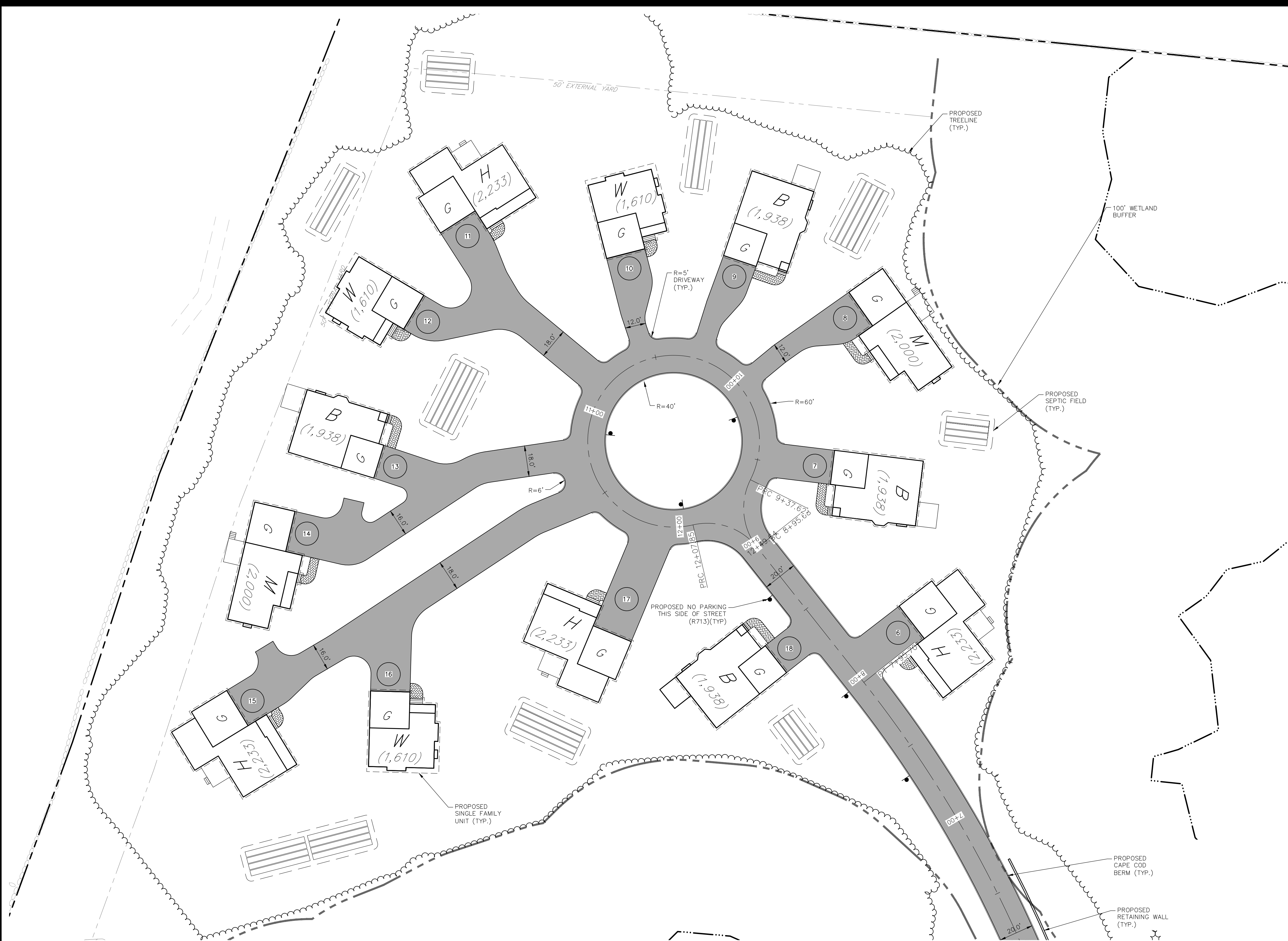

NOTES

1. THIS SITE PLAN SHALL BE RECORDED IN THE ROCKINGHAM COUNTY REGISTRY OF DEEDS.
2. ALL IMPROVEMENTS SHOWN ON THIS SITE PLAN SHALL BE CONSTRUCTED AND MAINTAINED IN ACCORDANCE WITH THE PLAN BY THE PROPERTY OWNER AND ALL FUTURE PROPERTY OWNERS. NO CHANGED SHALL BE MADE TO THIS SITE PLAN WITHOUT THE EXPRESS APPROVAL OF THE PORTSMOUTH PLANNING DIRECTOR.

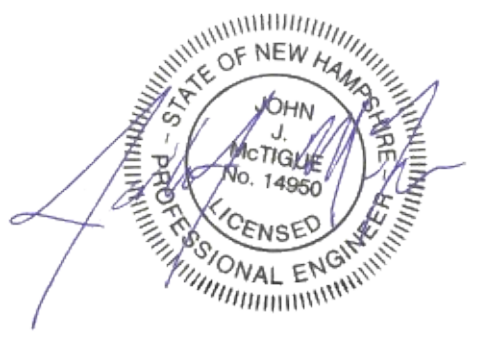

SITE DEVELOPMENT PLANS
TAX MAP 256 LOT 2
SITE LAYOUT PLAN
THE VILLAGE AT BANFIELD WOODS
PORTSMOUTH, NH
OWNED BY
WALTER D HETT TRUST
PREPARED FOR
GREEN & COMPANY REAL ESTATE
1"=60' (11"X17")
SCALE: 1"=30' (22"X34") **SEPTEMBER 25, 2019**

Copyright 2019 © Thomas F. Moran, Inc.
48 Constitution Drive, Bedford, N.H. 03110
All rights reserved. These plans and materials may not be copied, duplicated, replicated or otherwise reproduced in any form whatsoever without the prior written permission of Thomas F. Moran, Inc.
This plan is not effective unless signed by a duly authorized officer of Thomas F. Moran, Inc.

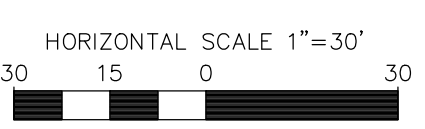

REV	DATE	DESCRIPTION	DR	CK
6	5/5/2020	AoT SUBMITTAL	RCK	JJM
5	4/29/2020	REVISER PER REGULATORY COMMENTS	RCK	JJM
4	3/20/2020	PROGRESS PRINT	RCK	JJM
3	3/4/2020	UPDATE PLANS PER REGULATORY COMMENTS	RCK	JJM
2	12/27/2019	IN HOUSE REVISIONS	RCK	JJM
1	12/23/19	NO REVISIONS THIS SHEET	RCK	JJM

TFM	Civil Engineers Structural Engineers Traffic Engineers Land Surveyors Landscape Architects Scientists			48 Constitution Drive Bedford, NH 03110 Phone (603) 472-4488 Fax (603) 472-9747 www.tfmoran.com
	FILE # 47361.00	DR RCK CK JJM	FB CADFILE	SITELAYOUT
				C-07

BEST MANAGEMENT PRACTICES FOR BLASTING

1. PURPOSE. THE PURPOSE OF THIS PART IS TO ESTABLISH BEST MANAGEMENT PRACTICES FOR BLASTING TO MINIMIZE THE POTENTIAL FOR GROUNDWATER CONTAMINATION, TO ENSURE THAT THE GROUNDWATER CAN BE USED FOR EXISTING AND FUTURE DRINKING WATER SUPPLY SOURCES. (SEE RN3 AT P. V) #12342, EFF 8-15-17
2. LOADING PRACTICES. THE FOLLOWING BLAST HOLE LOADING PRACTICES SHALL BE IMPLEMENTED:
 - A. THE DRILLER SHALL MAINTAIN DRILLING LOGS TO DOCUMENT:
 - I. THE DEPTHS AND LENGTHS OF VOIDS, CAVITIES, AND FAULT ZONES OR OTHER WEAK ZONES ENCOUNTERED; AND
 - II. GROUNDWATER CONDITIONS;
 - B. THE DRILLER SHALL COMMUNICATE THE CONTENTS OF THE DRILLING LOGS DIRECTLY TO THE BLASTER;
 - C. EXPLOSIVE PRODUCTS SHALL BE MANAGED ON SITE SUCH THAT THEY ARE:
 - I. USED IN THE BOREHOLE;
 - II. RETURNED TO THE DELIVERY VEHICLE; OR
 - III. PLACED IN SECURE CONTAINERS FOR OFF-SITE DISPOSAL;
 - D. SPILLAGE AROUND THE BOREHOLE SHALL BE:
 - I. PLACED IN THE BOREHOLE; OR
 - II. CLEANED UP AND RETURNED TO AN APPROPRIATE VEHICLE FOR HANDLING OR PLACEMENT IN SECURED CONTAINERS FOR OFF-SITE DISPOSAL;
 - E. LOADED EXPLOSIVES SHALL BE DETONATED AS SOON AS POSSIBLE AND NOT LEFT IN THE BLAST HOLES OVERNIGHT, UNLESS WEATHER OR OTHER SAFETY CONCERNS REASONABLY DICTATE THAT DETONATION SHOULD BE POSTPONED;
 - F. LOADING EQUIPMENT SHALL BE CLEANED IN AN AREA WHERE WASTEWATER CAN BE PROPERLY CONTAINED AND HANDLED IN A MANNER THAT PREVENTS RELEASE OF CONTAMINANTS TO THE ENVIRONMENT; AND
 - G. EXPLOSIVES SHALL BE LOADED IN ACCORDANCE WITH INDUSTRY STANDARD PRACTICES FOR PRIMING, STEMMING, DECKING AND COLUMN RISE TO MAINTAIN GOOD CONTINUITY IN THE COLUMN LOAD TO PROMOTE COMPLETE DETONATION. SOURCE. (SEE RN3 AT P. V) #12342, EFF 8-15-17
3. EXPLOSIVE SELECTION. EXPLOSIVE PRODUCTS SHALL BE SELECTED THAT ARE:
 - A. APPROPRIATE FOR SITE CONDITION AND SAFE BLAST EXECUTION; AND
 - B. HAVE THE APPROPRIATE WATER RESISTANCE FOR THE SITE CONDITIONS PRESENT.
4. PREVENTION OF MISFIRES. INDUSTRY-STANDARD PRACTICES SHALL BE IMPLEMENTED TO PREVENT MISFIRES.
5. MUCK AND ROCK MANAGEMENT.
 - A. FOR PURPOSES OF THIS PART, THE FOLLOWING DEFINITIONS APPLY:
 - I. "BLASTED MATERIAL" MEANS ALL OF THE EARTH MATERIAL LOOSENED AS A RESULT OF THE BLASTING;
 - II. "MUCK" MEANS THE BLASTED MATERIAL REMAINING AFTER THE ROCKS HAVE BEEN REMOVED; AND
 - III. "ROCKS" MEANS THE LARGER PIECES OF BLASTED MATERIAL THAT ARE SEPARATED FROM THE MUCK FOR USE ELSEWHERE, INCLUDING FOR FEEDSTOCK OF A ROCK CRUSHING OPERATION.
 - B. MUCK SHALL BE REMOVED FROM THE BLAST AREA AS SOON AS REASONABLY POSSIBLE.
 - C. ROCKS SHALL BE MANAGED SO AS TO PREVENT WATER SUPPLY WELLS OR SURFACE WATERS FROM BEING CONTAMINATED BY RUNOFF.
6. SPILL PREVENTION MEASURES AND SPILL MITIGATION.
 - A. FUEL AND OTHER REGULATED SUBSTANCES SHALL BE MANAGED AS REQUIRED BY ENV-WQ 401.04.
 - B. PERSONNEL WORKING AT THE BLAST SITE SHALL BE TRAINED IN HOW TO RESPOND TO A SPILL OF THE REGULATED SUBSTANCES BEING USED AT THE SITE.
7. FUELING AND MAINTENANCE OF CONSTRUCTION EQUIPMENT.
 - A. IF ANY CONSTRUCTION EQUIPMENT, INCLUDING BUT NOT LIMITED TO EARTHMOVING, EXCAVATION, AND BORING EQUIPMENT, WILL BE FUELED FROM A TANK TRUCK OR OTHER CONTAINER THAT IS MOVED AROUND THE SITE, THE FOLLOWING SHALL APPLY:
 - I. PORTABLE CONTAINMENT EQUIPMENT THAT IS SIZED TO CONTAIN THE MOST LIKELY VOLUME OF FUEL TO BE SPILLED DURING A FUEL TRANSFER SHALL BE USED, WHERE THE MOST LIKELY VOLUME TO BE SPILLED IS DETERMINED BASED ON THE FUEL TRANSFER RATE, THE AMOUNT OF FUEL BEING TRANSFERRED, THE DISTANCE BETWEEN THE HOSE NOZZLE AND PUMP SHUT OFF SWITCH, AND THE RESPONSE TIME OF PERSONNEL AND EQUIPMENT AVAILABLE AT THE FACILITY; THE CONTAINMENT EQUIPMENT SHALL BE POSITIONED TO CATCH ANY FUEL SPILLS DUE TO OVERFILLING THE EQUIPMENT AND ANY OTHER SPILLS THAT MIGHT OCCUR AT OR NEAR THE FUEL FILLER PORT TO THAT EQUIPMENT;
 - II. THE TYPE OF CONTAINMENT EQUIPMENT USED AND ITS POSITIONING AND USE SHALL ACCOUNT FOR ALL OF THE DRIP POINTS ASSOCIATED WITH THE FUEL FILLING PORT AND THE HOSE FROM THE FUEL DELIVERY TRUCK; AND
 - III. PERSONNEL SHALL NOT LEAVE THE IMMEDIATE AREA WHILE FUEL IS BEING TRANSFERRED, TO ENSURE THAT ANY SPILLS WILL BE OF LIMITED VOLUME.
 - B. IF THE SITE WILL HAVE A FIXED LOCATION FOR FUELING CONSTRUCTION EQUIPMENT, THE FOLLOWING SHALL APPLY:
 - I. ALL FUEL CONTAINERS, INCLUDING BUT NOT LIMITED TO SKID-MOUNTED TANKS, DRUMS, AND FIVE GALLON CANS, SHALL HAVE SECONDARY CONTAINMENT THAT:
 1. IS CAPABLE OF CONTAINING 110% OF THE VOLUME OF THE LARGEST FUEL STORAGE CONTAINER; AND
 2. HAS AN IMPERVIOUS FLOOR;
 - II. SECONDARY CONTAINMENT FOR TANKS MAY COMPRISE A METAL, PLASTIC, POLYMER OR PRECAST CONCRETE VAULT PROVIDING 110 PERCENT OF THE VOLUME OF THE LARGEST FUEL STORAGE CONTAINER;
 - III. FOR FUEL CONTAINERS, SECONDARY CONTAINMENT MAY COMPRISE CONTAINMENT PALLETS;
 - IV. THE AREA WHERE FUEL IS TRANSFERRED SHALL BE A FLAT, IMPERVIOUS AREA THAT:
 1. IS ADJACENT TO THE FUEL CONTAINER(S); AND
 2. EXTENDS BEYOND THE FULL REACH, OR LENGTH, OF THE FUEL HOSE; AND
 - V. SECONDARY CONTAINMENT AREAS MAY BE IN THE FORM OF A BASIN THAT IS:
 1. SLOPED DOWN TO A CENTRAL LOW POINT OR BERMED ALONG THE PERIMETER;
 2. LINED WITH A CONTINUOUS SHEET OF 20 MIL OR THICKER POLYMER MATERIAL OR APPROPRIATE GEOMEMBRANE LINER; AND
 3. BACKFILLED WITH AT LEAST 6 INCHES OF SAND.

- NOTES:
1. A THIRD PARTY SHALL INSPECTOR SHALL BE ON SITE TO INSPECT THE INSTALLATION OF THE STORM DRAINAGE SYSTEMS.
 2. SEE GRADING NOTES ON NOTES & LEGEND SHEET (C-01).



SITE DEVELOPMENT PLANS

TAX MAP 256 LOT 2
OVERALL GRADING & DRAINAGE PLAN
 THE VILLAGE AT BANFIELD WOODS
 PORTSMOUTH, NH

OWNED BY
WALTER D HETT TRUST
 PREPARED FOR
GREEN & COMPANY REAL ESTATE
 1"=160' (11"X17")
 SCALE: 1"=80' (22"X34") **SEPTEMBER 25, 2019**

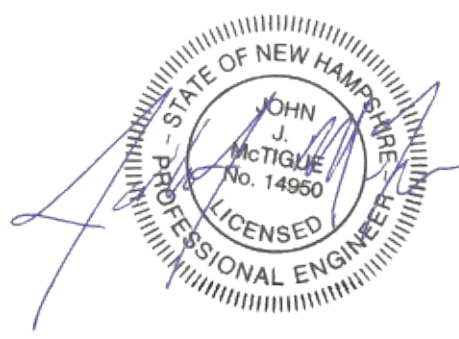

REV	DATE	DESCRIPTION	DR	CK
1	12/23/19	REVISED PER REGULATORY COMMENTS	RCK	JJM
2	12/27/2019	IN HOUSE REVISIONS	RCK	JJM
3	3/4/2020	UPDATE PLANS PER REGULATORY COMMENTS	RCK	JJM
4	3/20/2020	PROGRESS PRINT	RCK	JJM
5	4/29/2020	REVISER PER REGULATORY COMMENTS	RCK	JJM
6	5/5/2020	AoT SUBMITTAL	RCK	JJM

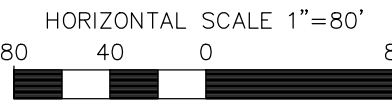

Copyright 2019 © Thomas F. Moran, Inc.
 48 Constitution Drive, Bedford, N.H. 03110
 All rights reserved. These plans and materials may not be copied, duplicated, replicated or otherwise reproduced in any form whatsoever without the prior written permission of Thomas F. Moran, Inc.
 This plan is not effective unless signed by a duly authorized officer of Thomas F. Moran, Inc.



TFM Civil Engineers
 Structural Engineers
 Traffic Engineers
 Land Surveyors
 Landscape Architects
 Scientists

48 Constitution Drive
 Bedford, NH 03110
 Phone (603) 472-4488
 Fax (603) 472-9747
 www.tfmoran.com

47361.00 DR RCK FB
 CK JJM CADFILE GRADING/DRAINAGE C-08

May 28, 2020 - 11:56am F:\MISC Projects\47361 - Portsmouth\47361-00 - Green & Co - Banfield Road\Design\Production Drawings\Grading\Drainage.dwg

May 28, 2020 - 5:29pm F:\MSC Projects\47361 - Portsmouth\47361-00 - Green & Co - Banfield Road\Design\Production Drawings\Grading\Drainage.dwg

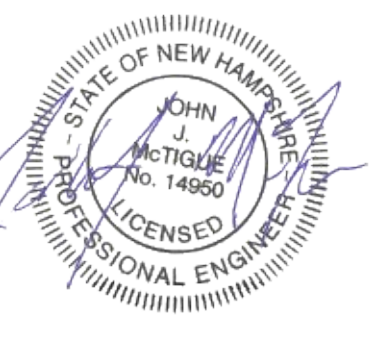
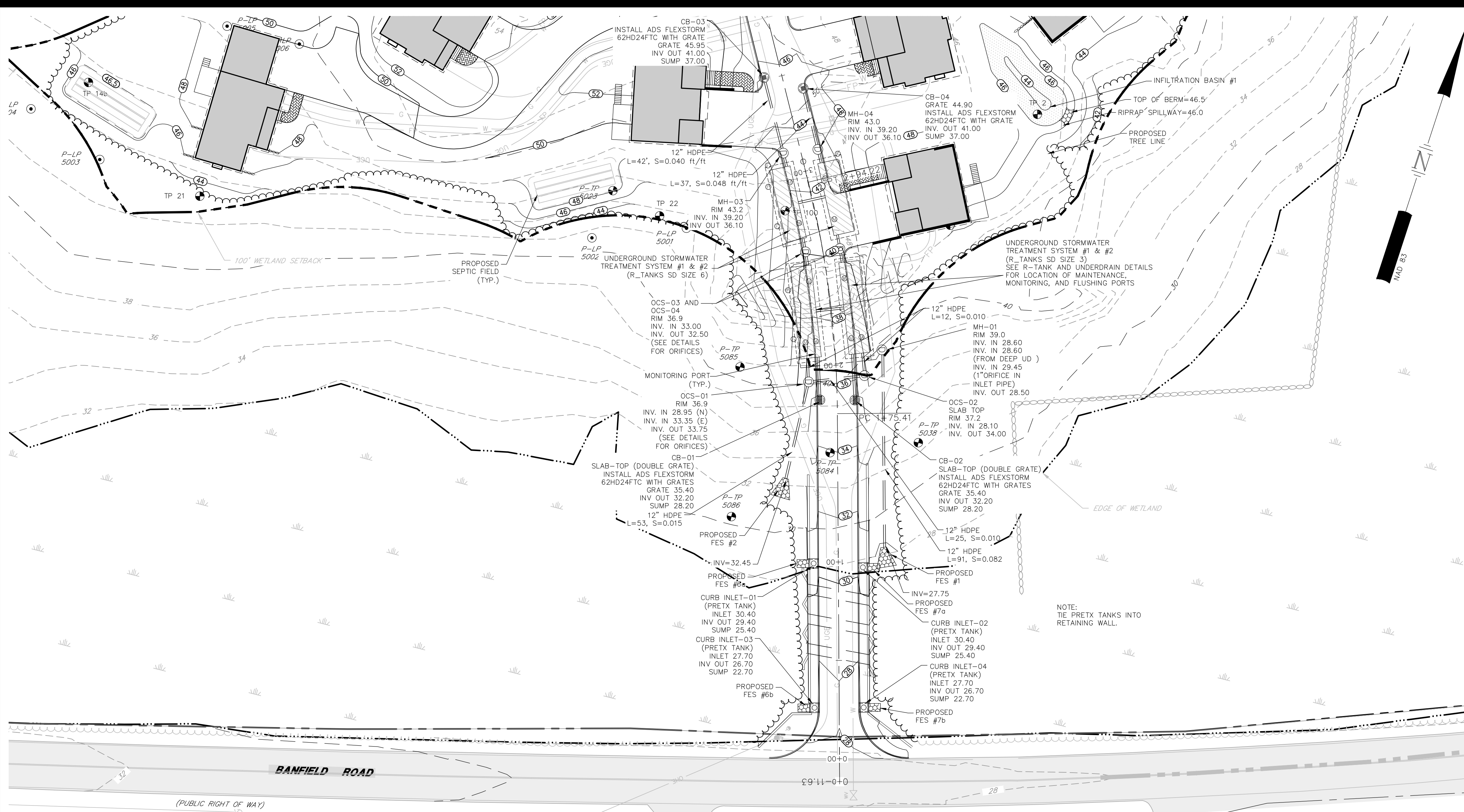

SITE DEVELOPMENT PLANS

TAX MAP 256 LOT 2
GRADING & DRAINAGE PLAN
THE VILLAGE AT BANFIELD WOODS
PORTSMOUTH, NH

OWNED BY
WALTER D HETT TRUST

PREPARED FOR
GREEN & COMPANY REAL ESTATE
1"=60' (11'X17')

SCALE: 1"=30' (22'X34") **SEPTEMBER 25, 2019**

Copyright 2019 © Thomas F. Moran, Inc.
 48 Constitution Drive, Bedford, N.H. 03110
 All rights reserved. These plans and materials may not be copied, duplicated, replicated or otherwise reproduced in any form whatsoever without the prior written permission of Thomas F. Moran, Inc.
 This plan is not effective unless signed by a duly authorized officer of Thomas F. Moran, Inc.

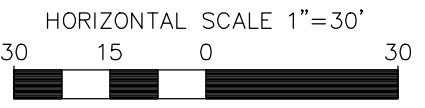

REV	DATE	DESCRIPTION	DR	CK
6	5/5/2020	AoT SUBMITTAL	RCK	JJM
5	4/29/2020	REVISOR PER REGULATORY COMMENTS	RCK	JJM
4	3/20/2020	PROGRESS PRINT	RCK	JJM
3	3/4/2020	UPDATE PLANS PER REGULATORY COMMENTS	RCK	JJM
2	12/27/2019	IN HOUSE REVISIONS	RCK	JJM
1	12/23/19	REVISED PER REGULATORY COMMENTS	RCK	JJM

	Civil Engineers Structural Engineers Traffic Engineers Land Surveyors Landscape Architects Scientists	48 Constitution Drive Bedford, NH 03110 Phone (603) 472-4488 Fax (603) 472-9747 www.tfmoran.com
	FILE 47361.00 DR RCK FB CK JJM CADFILE GRADING/DRAINAGE	C-09

May 28, 2020 - 11:56am
F:\MISC Projects\47361 - Portsmouth\47361-00 - Green & Co - Banfield Road\Design\Production Drawings\Grading\Drainage.dwg

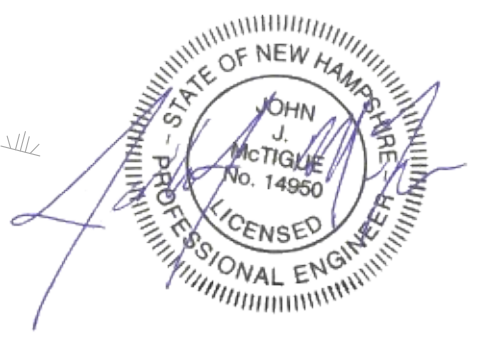
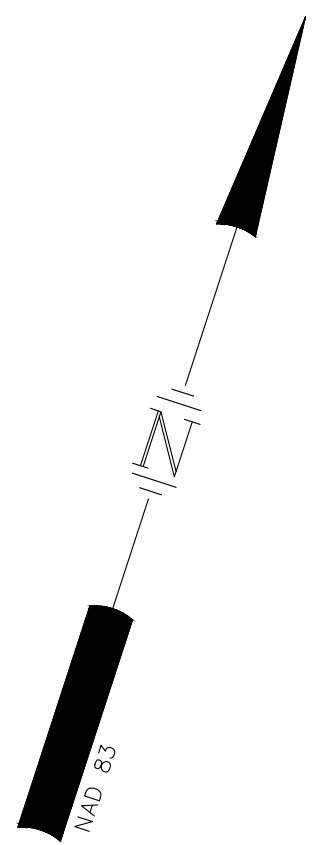
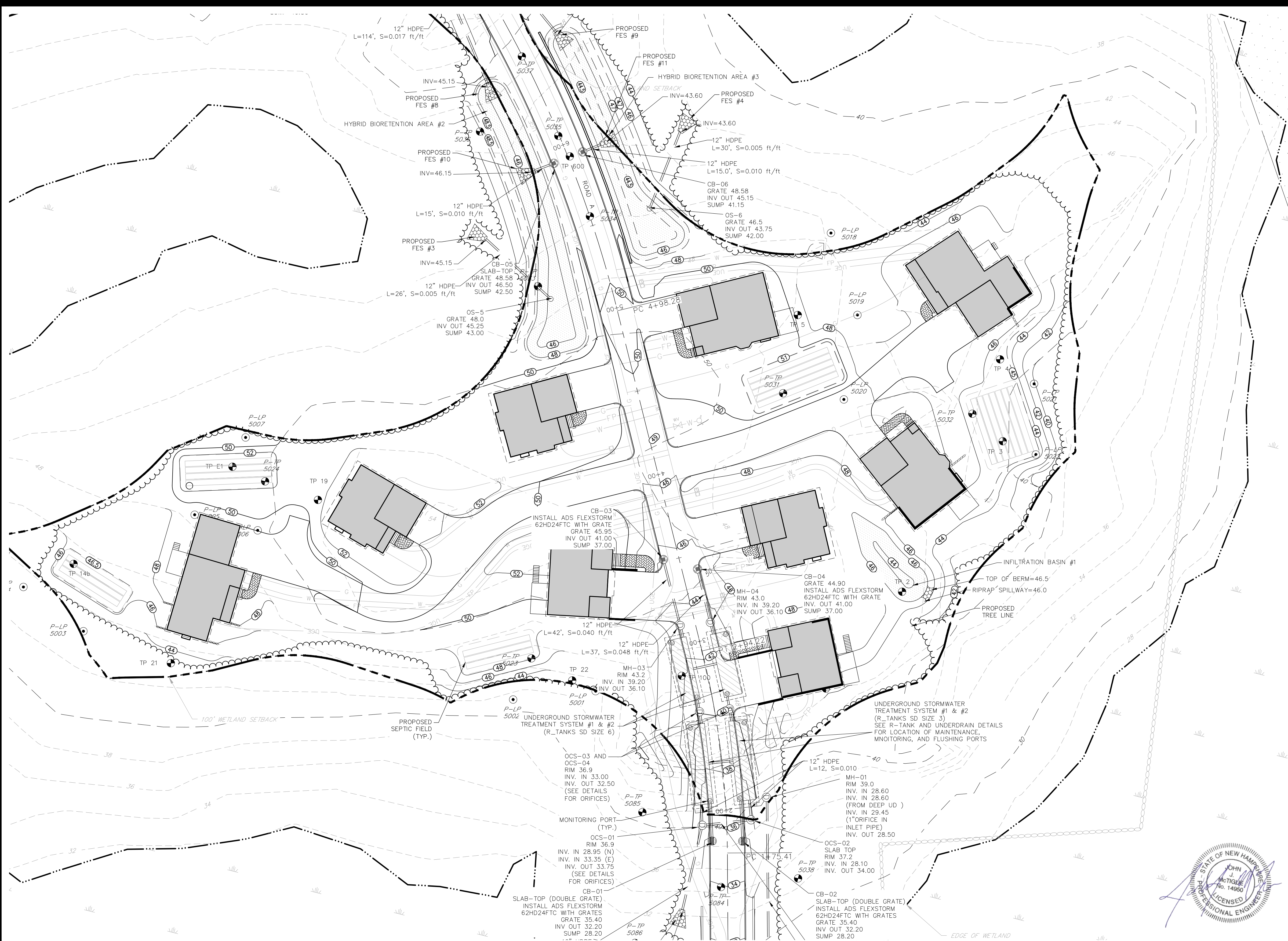

SITE DEVELOPMENT PLANS
 TAX MAP 256 LOT 2
GRADING & DRAINAGE PLAN
THE VILLAGE AT BANFIELD WOODS
PORTSMOUTH, NH
 OWNED BY
WALTER D HETT TRUST
 PREPARED FOR
GREEN & COMPANY REAL ESTATE
1"=60' (11'X17')
SCALE: 1"=30' (22'X34') **SEPTEMBER 25, 2019**

Copyright 2019 © Thomas F. Moran, Inc.
 48 Constitution Drive, Bedford, N.H. 03110
 All rights reserved. These plans and materials may not be copied, duplicated, replicated or otherwise reproduced in any form whatsoever without the prior written permission of Thomas F. Moran, Inc.
 This plan is not effective unless signed by a duly authorized officer of Thomas F. Moran, Inc.

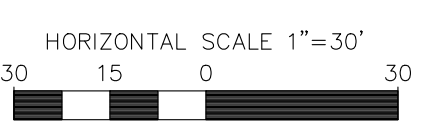

REV	DATE	DESCRIPTION	DR	CK
6	5/5/2020	AoT SUBMITTAL	RCK	JJM
5	4/29/2020	REVISOR PER REGULATORY COMMENTS	RCK	JJM
4	3/20/2020	PROGRESS PRINT	RCK	JJM
3	3/4/2020	UPDATE PLANS PER REGULATORY COMMENTS	RCK	JJM
2	12/27/2019	IN HOUSE REVISIONS	RCK	JJM
1	12/23/19	REVISED PER REGULATORY COMMENTS	RCK	JJM

TFM	Civil Engineers	48 Constitution Drive
	Structural Engineers	Bedford, NH 03110
	Traffic Engineers	Phone (603) 472-4488
	Land Surveyors	Fax (603) 472-9747
	Landscape Architects	www.tfmoran.com
	Scientists	

47361.00 C-10

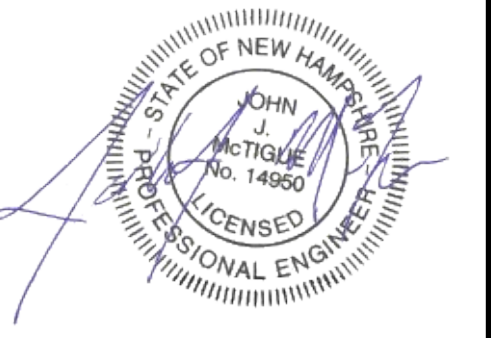
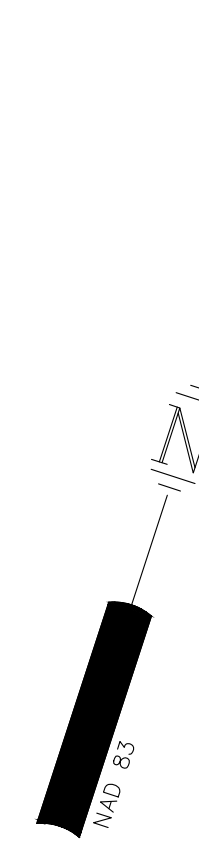

SITE DEVELOPMENT PLANS
 TAX MAP 256 LOT 2
GRADING & DRAINAGE PLAN
THE VILLAGE AT BANFIELD WOODS
 PORTSMOUTH, NH
 OWNED BY
WALTER D HETT TRUST
 PREPARED FOR
GREEN & COMPANY REAL ESTATE
1"=60' (11'X17")
SCALE: 1"=30' (22'X34") **SEPTEMBER 25, 2019**

Copyright 2019 © Thomas F. Moran, Inc.
 48 Constitution Drive, Bedford, N.H. 03110
 All rights reserved. These plans and materials may not be copied, duplicated, replicated or otherwise reproduced in any form whatsoever without the prior written permission of Thomas F. Moran, Inc.
 This plan is not effective unless signed by a duly authorized officer of Thomas F. Moran, Inc.

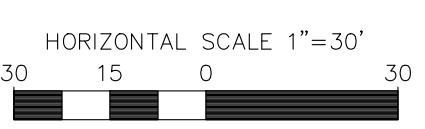

REV	DATE	DESCRIPTION	DR	CK
6	5/5/2020	AoT SUBMITTAL	RCK	JJM
5	4/29/2020	REVISOR PER REGULATORY COMMENTS	RCK	JJM
4	3/20/2020	PROGRESS PRINT	RCK	JJM
3	3/4/2020	UPDATE PLANS PER REGULATORY COMMENTS	RCK	JJM
2	12/27/2019	IN HOUSE REVISIONS	RCK	JJM
1	12/23/19	REVISED PER REGULATORY COMMENTS	RCK	JJM

TFM	Civil Engineers	48 Constitution Drive
	Structural Engineers	Bedford, NH 03110
	Traffic Engineers	Phone (603) 472-4488
	Land Surveyors	Fax (603) 472-9747
	Landscape Architects	www.tfmoran.com
	Scientists	

47361.00	DR RCK FB	CK JUM CADFILE	GRADING/DRAINAGE	C-11
----------	-----------	----------------	------------------	------

May 28, 2020 - 11:57am F:\MISC Projects\47361 - Portsmouth\47361-00 - Green & Co - Banfield Road\Design\Production Drawings\Grading\Drainage.dwg

NOTES

1. ALL CONDOMINIUM UNITS SHALL HAVE FIRE SUPPRESSION SPRINKLERS SYSTEMS INSTALLED.
2. SEE UTILITY NOTES ON NOTES & LEGEND SHEET (C-01).
3. A THIRD PARTY INSPECTOR SHALL BE ON SITE TO INSPECT THE INSTALLATION OF THE UTILITIES.

UTILITY COLOR LEGEND	
WATER	
SEPTIC	
ELECTRIC & COMMUNICATIONS	
GAS	

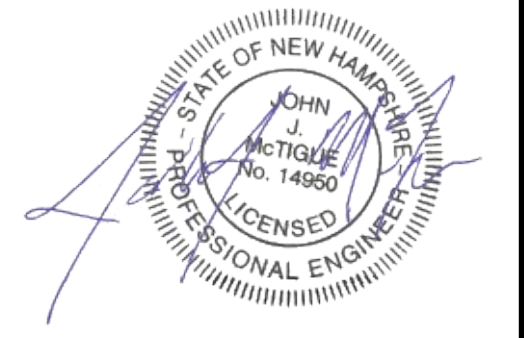
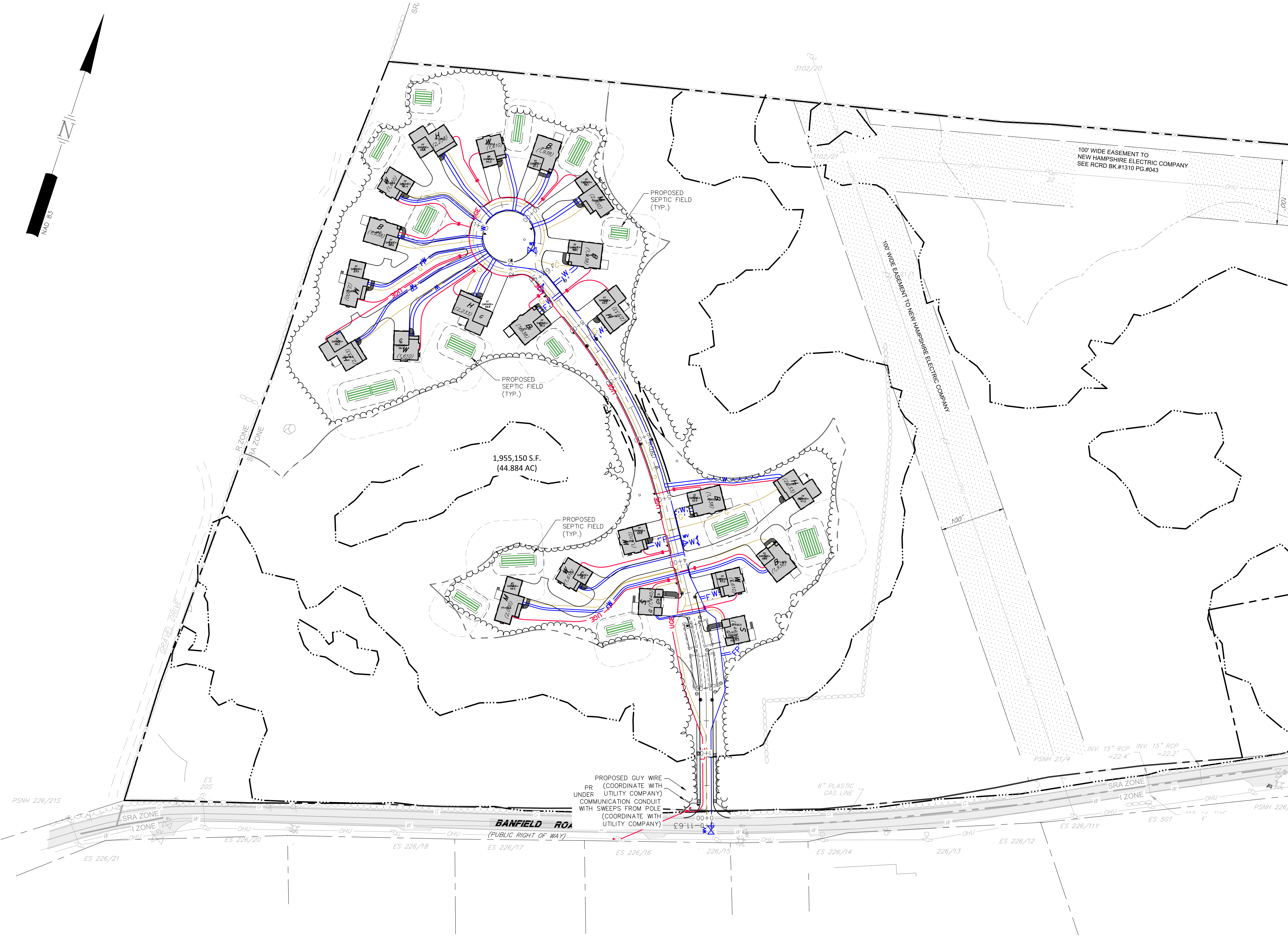

SITE DEVELOPMENT PLANS

TAX MAP 256 LOT 2
OVERALL UTILITY PLAN
THE VILLAGE AT BANFIELD WOODS
PORTSMOUTH, NH

OWNED BY
WALTER D HETT TRUST
 PREPARED FOR
GREEN & COMPANY REAL ESTATE
1"=160' (11"X17")
SCALE: 1"=80' (22"X34") **SEPTEMBER 25, 2019**

REV	DATE	DESCRIPTION	DR	CK
6	5/5/2020	AoT SUBMITTAL	RCK	JJM
5	4/29/2020	REVISER PER REGULATORY COMMENTS	RCK	JJM
4	3/20/2020	PROGRESS PRINT	RCK	JJM
3	3/4/2020	UPDATE PLANS PER REGULATORY COMMENTS	RCK	JJM
2	12/27/2019	IN HOUSE REVISIONS	RCK	JJM
1	12/23/19	NO REVISIONS THIS SHEET	RCK	JJM

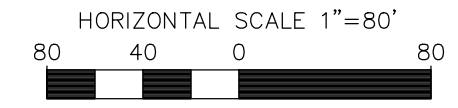

Copyright 2019 © Thomas F. Moran, Inc.
 48 Constitution Drive, Bedford, N.H. 03110
 All rights reserved. These plans and materials may not be copied, duplicated, replicated or otherwise reproduced in any form whatsoever without the prior written permission of Thomas F. Moran, Inc.
 This plan is not effective unless signed by a duly authorized officer of Thomas F. Moran, Inc.



	Civil Engineers	48 Constitution Drive
	Structural Engineers	Bedford, NH 03110
	Traffic Engineers	Phone (603) 472-4488
	Land Surveyors	Fax (603) 472-9747
	Landscape Architects	www.tfmoran.com
	Scientists	

May 28, 2020 - 11:57am F:\MISC Projects\47361 - Banfield Road - Portsmouth\47361-00 - Green & Co - Banfield Road\Design\Production Drawings\Utility.dwg

May 28, 2020 - 11:58am F:\MISC Projects\47361 - Portsmouth\47361-00 - Green & Co - Banfield Road\Design\Production Drawings\Utility.dwg

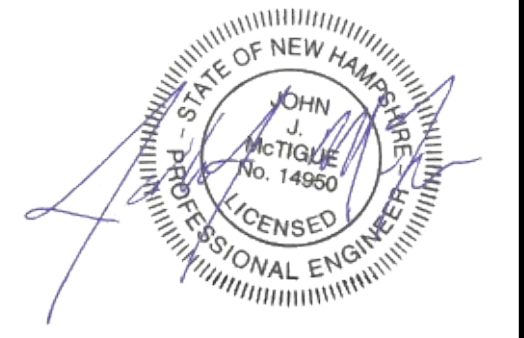
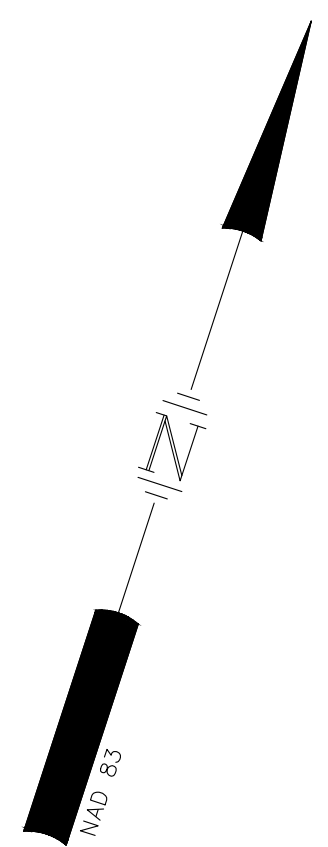
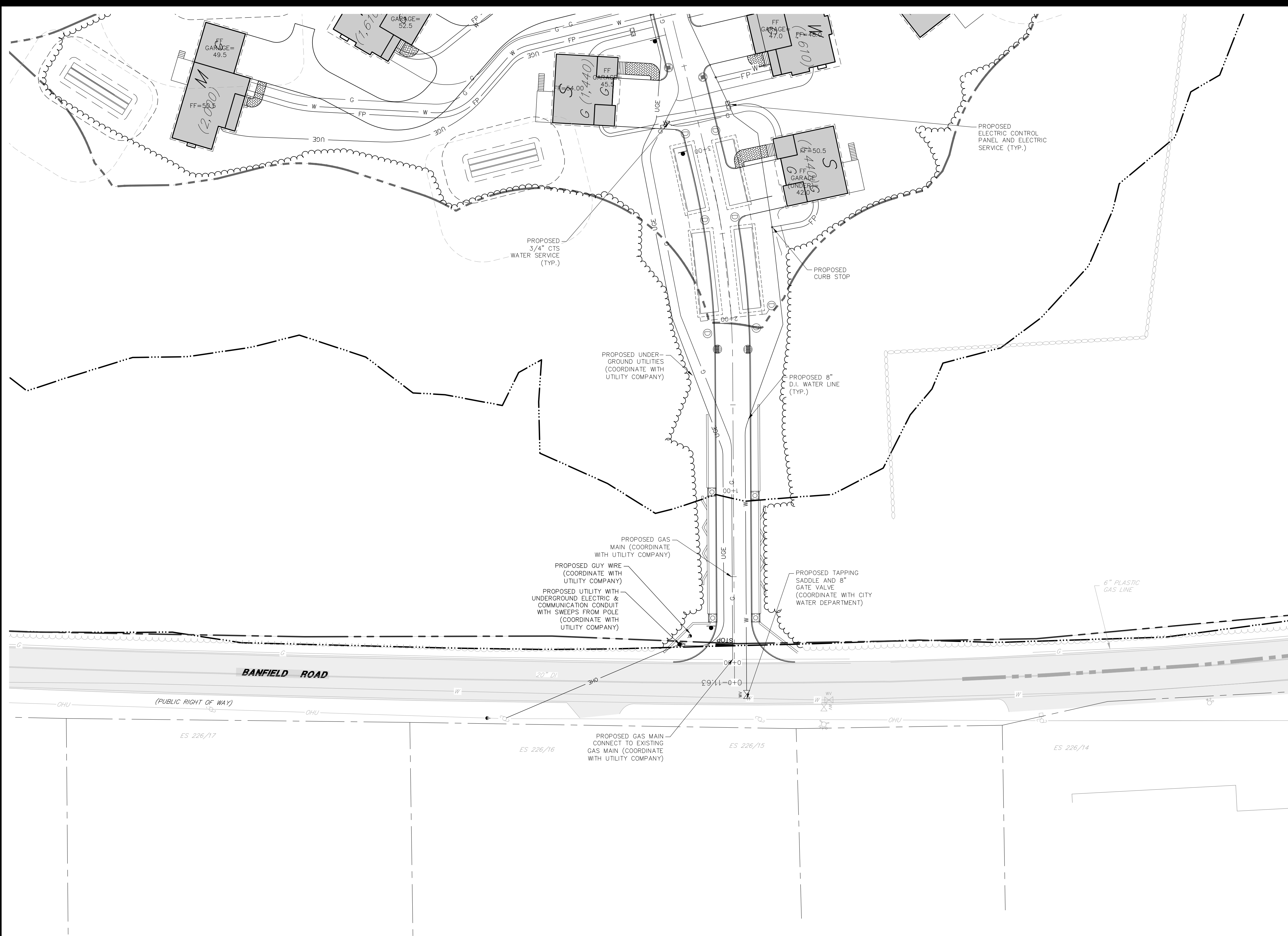

SITE DEVELOPMENT PLANS
TAX MAP 256 LOT 2
UTILITY PLAN
THE VILLAGE AT BANFIELD WOODS
PORTSMOUTH, NH
OWNED BY
WALTER D HETT TRUST
PREPARED FOR
GREEN & COMPANY REAL ESTATE
1"=60' (11"X17")
SCALE: 1"=30' (22"X34") **SEPTEMBER 25, 2019**

Copyright 2019 © Thomas F. Moran, Inc.
48 Constitution Drive, Bedford, N.H. 03110
All rights reserved. These plans and materials may not be copied, duplicated, replicated or otherwise reproduced in any form whatsoever without the prior written permission of Thomas F. Moran, Inc.
This plan is not effective unless signed by a duly authorized officer of Thomas F. Moran, Inc.

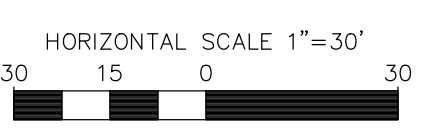

REV	DATE	DESCRIPTION	DR	CK
6	5/5/2020	AoT SUBMITTAL	RCK	JJM
5	4/29/2020	REVISOR PER REGULATORY COMMENTS	RCK	JJM
4	3/20/2020	PROGRESS PRINT	RCK	JJM
3	3/4/2020	UPDATE PLANS PER REGULATORY COMMENTS	RCK	JJM
2	12/27/2019	IN HOUSE REVISIONS	RCK	JJM
1	12/23/19	NO REVISIONS THIS SHEET	RCK	JJM

TFM	Civil Engineers	48 Constitution Drive
	Structural Engineers	Bedford, NH 03110
	Traffic Engineers	Phone (603) 472-4488
	Land Surveyors	Fax (603) 472-9747
	Landscape Architects	www.tfmoran.com
	Scientists	

47361.00 DR RCK FB -
CK JMM CADFILE UTILITY C-13

May 28, 2020 - 11:58am
F:\MISC Projects\47381 - Banfield Road - Portsmouth\47381-00 - Green & Co - Banfield Road\Design\Production Drawings\Utility.dwg

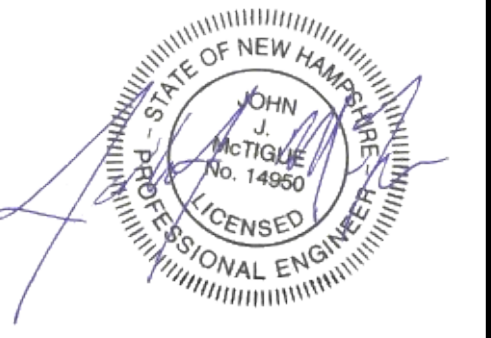
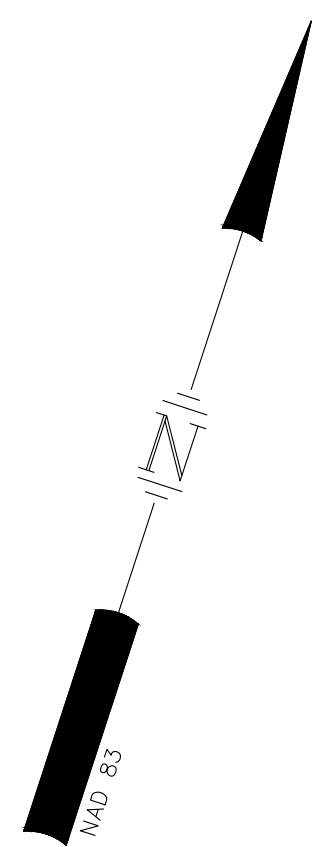
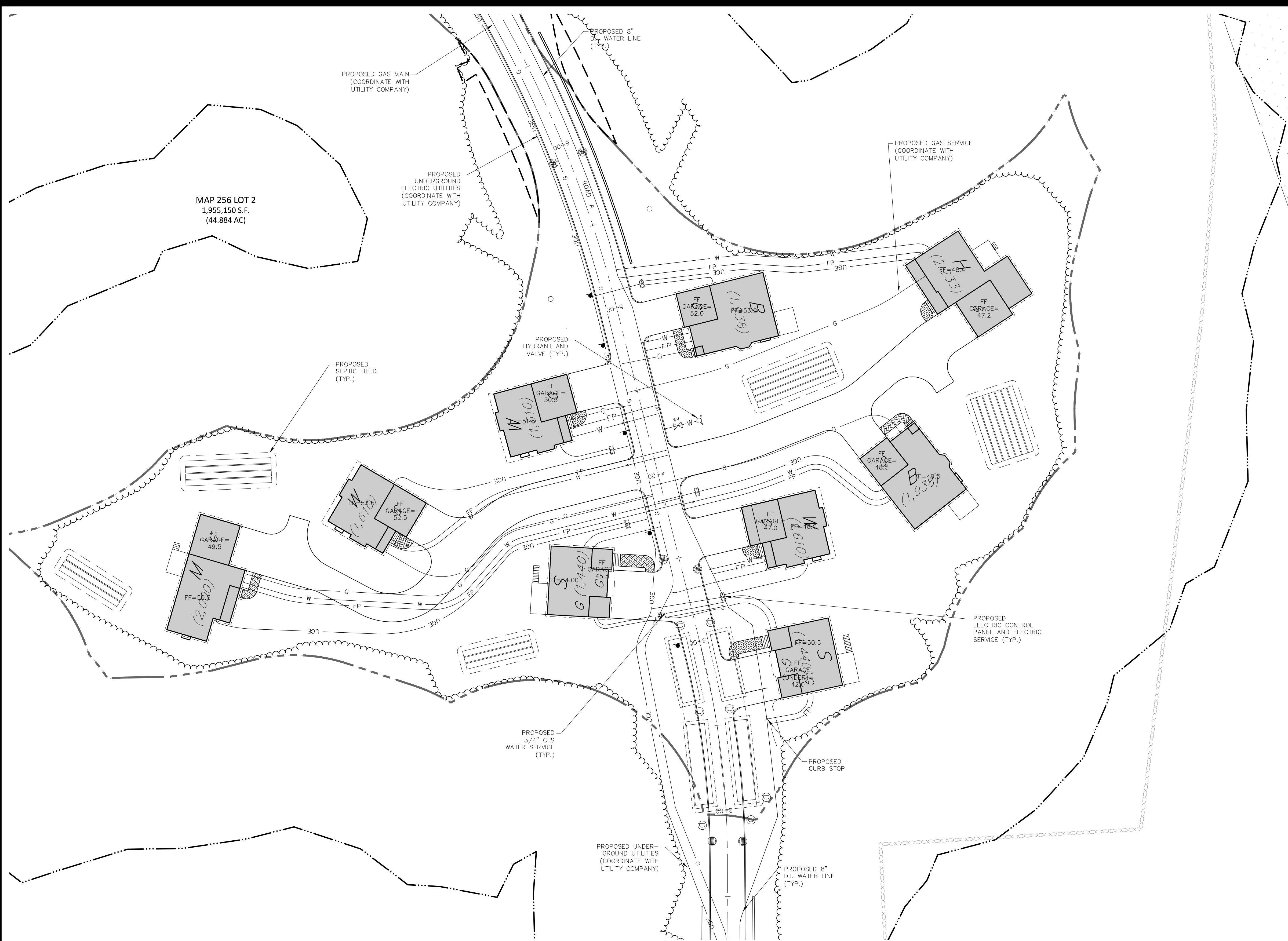

SITE DEVELOPMENT PLANS

TAX MAP 256 LOT 2
UTILITY PLAN
THE VILLAGE AT BANFIELD WOODS
PORTSMOUTH, NH

OWNED BY
WALTER D HETT TRUST
PREPARED FOR
GREEN & COMPANY REAL ESTATE
1"=60' (11"X17")
SCALE: 1"=30' (22"X34") **SEPTEMBER 25, 2019**

Copyright 2019 © Thomas F. Moran, Inc.
48 Constitution Drive, Bedford, N.H. 03110

All rights reserved. These plans and materials may not be copied, duplicated, replicated or otherwise reproduced in any form whatsoever without the prior written permission of Thomas F. Moran, Inc.

This plan is not effective unless signed by a duly authorized officer of Thomas F. Moran, Inc.

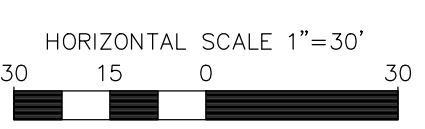

REV	DATE	DESCRIPTION	DR	CK
6	5/5/2020	AoT SUBMITTAL	RCK	JJM
5	4/29/2020	REVISOR PER REGULATORY COMMENTS	RCK	JJM
4	3/20/2020	PROGRESS PRINT	RCK	JJM
3	3/4/2020	UPDATE PLANS PER REGULATORY COMMENTS	RCK	JJM
2	12/27/2019	IN HOUSE REVISIONS	RCK	JJM
1	12/23/19	NO REVISIONS THIS SHEET	RCK	JJM

TFM	Civil Engineers	48 Constitution Drive
	Structural Engineers	Bedford, NH 03110
	Traffic Engineers	Phone (603) 472-4488
	Land Surveyors	Fax (603) 472-9747
	Landscape Architects	www.tfmoran.com
	Scientists	

47361.00	DR RCK	FB	-	
	CK JJM	CADFILE	UTILITY	C-14

May 28, 2020 - 11:58am F:\MISC Projects\47361 - Portsmouth\47361-00 - Green & Co - Banfield Road\Design\Production Drawings\Utility.dwg

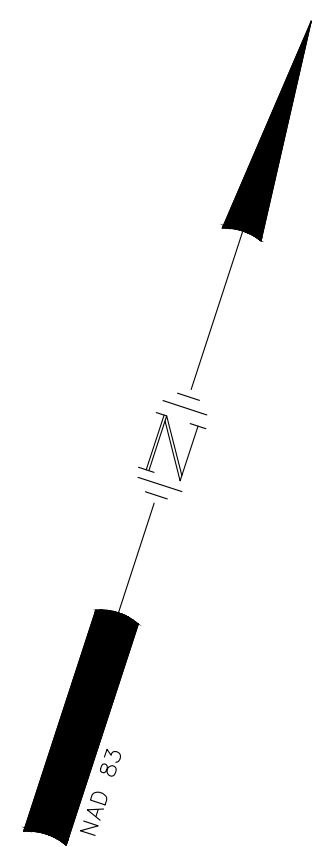
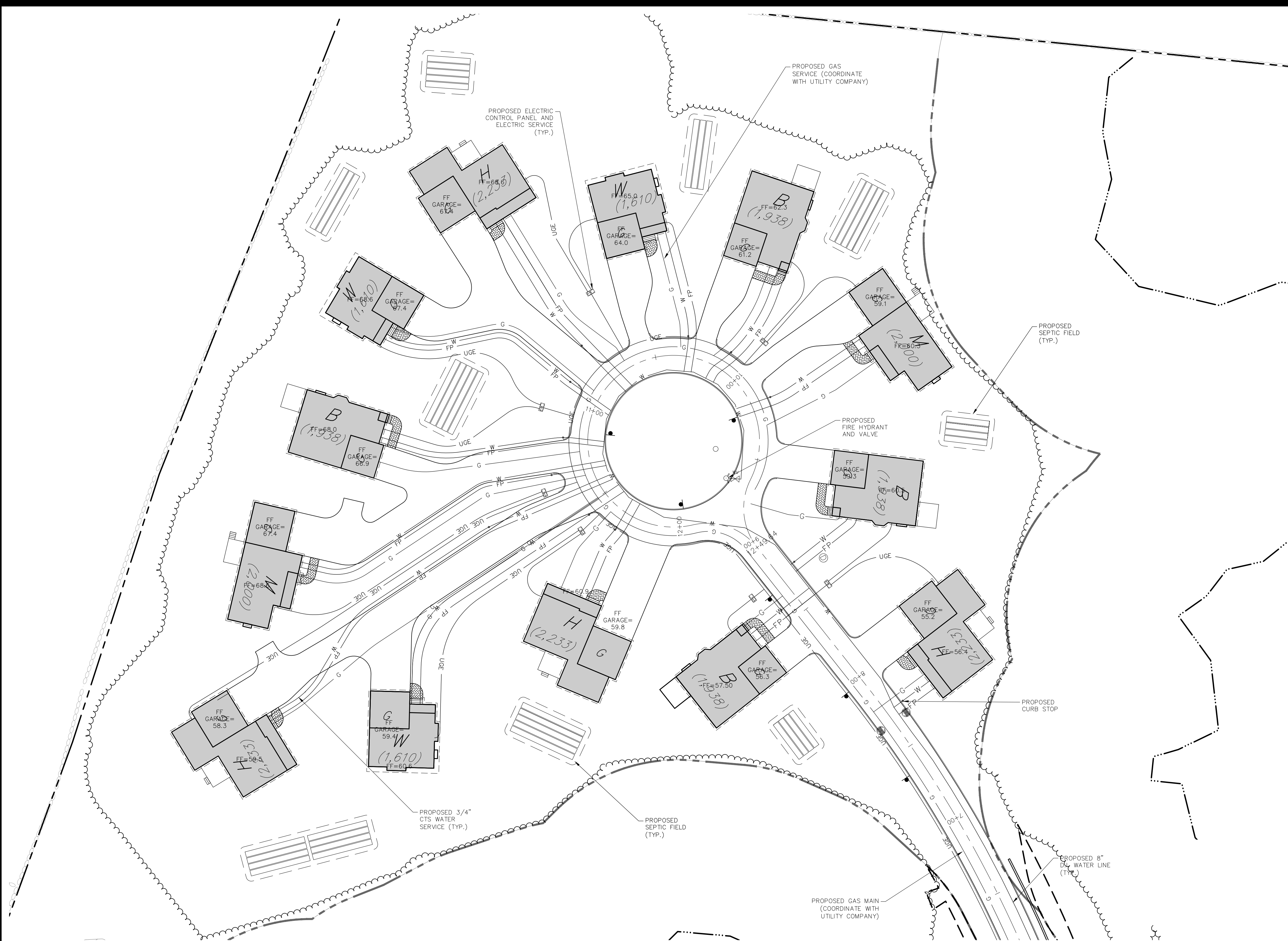

SITE DEVELOPMENT PLANS
 TAX MAP 256 LOT 2
UTILITY PLAN
THE VILLAGE AT BANFIELD WOODS
PORTSMOUTH, NH
 OWNED BY
WALTER D HETT TRUST
 PREPARED FOR
GREEN & COMPANY REAL ESTATE
1"=60' (11"X17")
SCALE: 1"=30' (22"X34") **SEPTEMBER 25, 2019**

Copyright 2019 © Thomas F. Moran, Inc.
 48 Constitution Drive, Bedford, N.H. 03110
 All rights reserved. These plans and materials may not be copied, duplicated, replicated or otherwise reproduced in any form whatsoever without the prior written permission of Thomas F. Moran, Inc.
 This plan is not effective unless signed by a duly authorized officer of Thomas F. Moran, Inc.

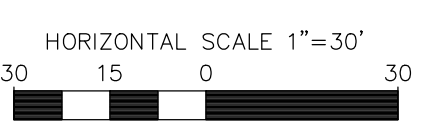

REV	DATE	DESCRIPTION	DR	CK
6	5/5/2020	AoT SUBMITTAL	RCK	JJM
5	4/29/2020	REVISOR PER REGULATORY COMMENTS	RCK	JJM
4	3/20/2020	PROGRESS PRINT	RCK	JJM
3	3/4/2020	UPDATE PLANS PER REGULATORY COMMENTS	RCK	JJM
2	12/27/2019	IN HOUSE REVISIONS	RCK	JJM
1	12/23/19	NO REVISIONS THIS SHEET	RCK	JJM

TFM	Civil Engineers	48 Constitution Drive
	Structural Engineers	Bedford, NH 03110
	Traffic Engineers	Phone (603) 472-4488
	Land Surveyors	Fax (603) 472-9747
	Landscape Architects	www.tfmoran.com
	Scientists	

FILE NO: 47361.00	DR: RCK	FB: -	UTILITY	C-15
	CK: JJM	CADFILE:		

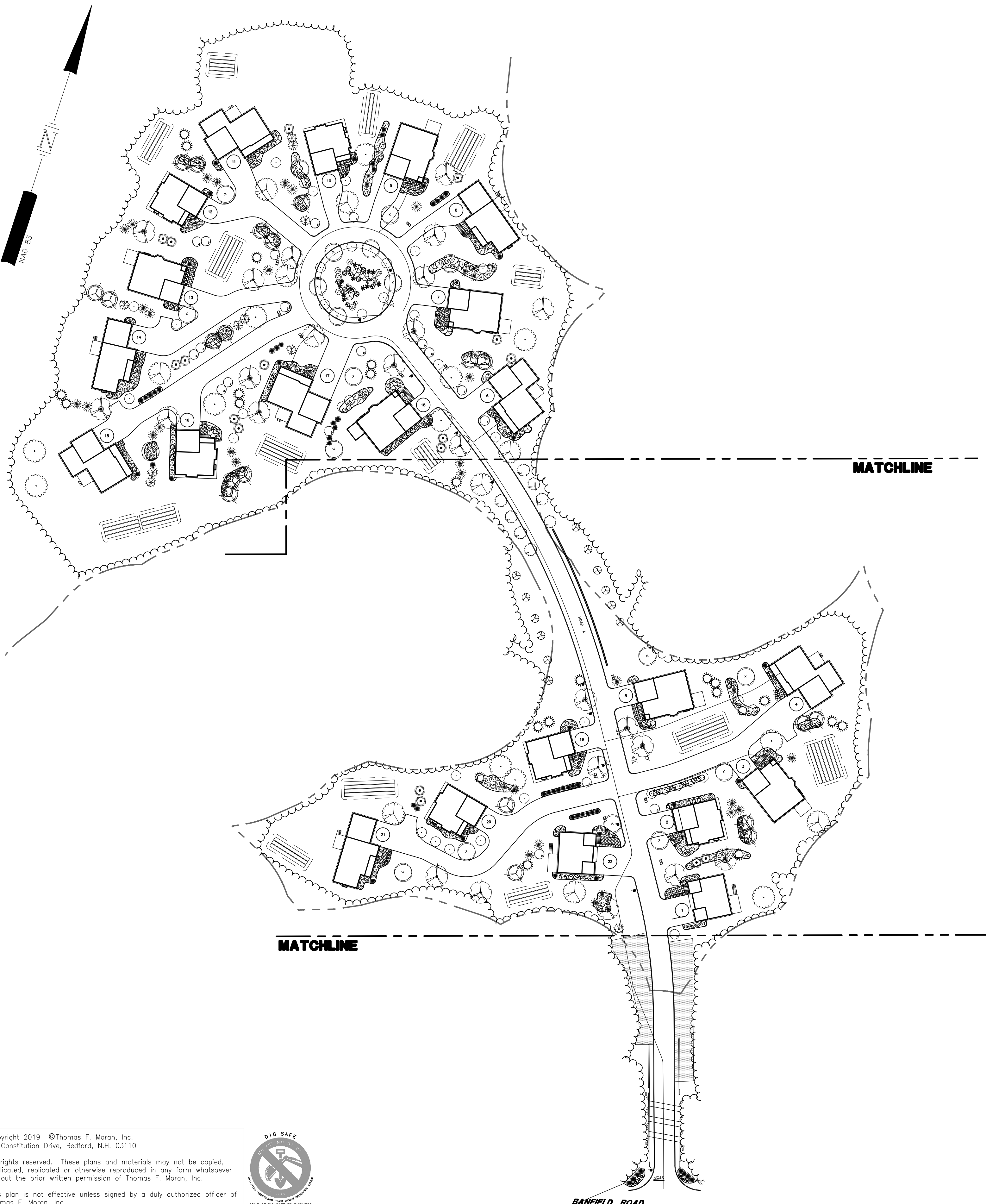

LANDSCAPE NOTES

1. CONTRACTOR WILL LOCATE, VERIFY AND MARK ALL EXISTING AND NEWLY INSTALLED UNDERGROUND UTILITIES PRIOR TO ANY LAWNWORK OR PLANTING. ANY CONFLICTS WHICH MIGHT OCCUR BETWEEN PLANTING AND UTILITIES WILL IMMEDIATELY BE REPORTED TO THE LANDSCAPE ARCHITECT OR OWNERS' REPRESENTATIVE, SO THAT ALTERNATE PLANTING LOCATIONS CAN BE DETERMINED.
2. CONTRACTOR WILL FURNISH AND PLANT ALL PLANTS IN QUANTITIES AS SHOWN ON THIS PLAN. IN CASES OF DISCREPANCY BETWEEN PLAN AND LIST CLARIFY WITH LANDSCAPE ARCHITECT PRIOR TO PLACING PURCHASE ORDER AND AGAIN PRIOR TO PLANTING.
3. SEE PLANTING DETAILS AND IF INCLUDED, SPECIFICATIONS FOR ADDITIONAL INFORMATION.
4. PLANT TYPES MAY VARY BASED ON AVAILABILITY AND SUPPLY. THIS LAYOUT REPRESENTS THE INTENT OF THE PLANTING AND APPROXIMATE NUMBERS OF PLANTS TO BE PROVIDED.
5. IT IS THE CONTRACTOR'S RESPONSIBILITY TO MAKE THE APPROPRIATE ARRANGEMENTS TO PROVIDE ALL PLANTS AND MATERIALS TO ACCOMMODATE PLANTING WITHIN THE TIME ALLOWED BY THE CONSTRUCTION SCHEDULE.
6. PLANTING SHALL BE COMPLETED FROM APRIL 15TH THROUGH OCTOBER 15TH UNLESS OTHERWISE NOTED IN SPECIFICATIONS. THERE WILL BE NO PLANTING DURING JULY AND AUGUST UNLESS SPECIAL PROVISIONS ARE MADE FOR DROUGHT BY PROVIDING ADDITIONAL WATERING.
7. ALL PLANTS WILL BE NURSERY GROWN.
8. PLANTS WILL BE IN ACCORDANCE, AT A MINIMUM, WITH CURRENT EDITION OF "AMERICAN STANDARDS FOR NURSERY STOCK" AS PUBLISHED BY THE AMERICAN HORTICULTURE INDUSTRY ASSOCIATION.
9. TREES WILL BE PRUNED IN ACCORDANCE WITH THE LATEST EDITION OF ANSI A300 PART 1, "TREE, SHRUB AND OTHER WOODY PLANT MAINTENANCE STANDARD PRACTICES".
10. PLANTS MATERIAL IS SUBJECT TO APPROVAL / REJECTION BY THE LANDSCAPE ARCHITECT AT THE SITE AND AT THE NURSERY.
11. ALL PLANTS WILL BE MOVED WITH ROOT SYSTEMS AS SOLID UNITS AND WITH BALLS OF EARTH FIRMLY WRAPPED WITH BURLAP. NO PLANT WILL BE ACCEPTED WHEN BALL OF EARTH SURROUNDING ITS ROOTS HAS BEEN BADLY CRACKED OR BROKEN BEFORE PLANTING. ALL PLANTS THAT CANNOT BE PLANTED AT ONCE WILL BE HEEL-IN BY SETTING IN THE GROUND AND COVERING THE BALLS WITH SOIL AND THEN WATERING. DURING TRANSPORT, ALL PLANT MATERIALS WILL BE WRAPPED WITH WIND PROOF COVERING.
12. NEWLY PLANTED MATERIAL WILL BEAR THE SAME RELATIONSHIP TO FINISHED GRADE AS TO THE ORIGINAL GRADE OF THE PLANT PRIOR TO DIGGING.
13. PROPOSED TREES OVERHANGING SIDEWALKS, ROADS OR PARKING WILL BEGIN BRANCHING NATURALLY (NOT PRUNED) AT 6' HEIGHT.
14. MULCH FOR PLANTED AREAS (NOT INCLUDING RAIN GARDENS) WILL BE AGED SHREDDED PINE BARK, PARTIALLY DECOMPOSED, DARK BROWN IN COLOR AND FREE OF WOOD CHIPS UNLESS OTHERWISE SHOWN.
15. PLANT MATERIAL WILL BE LOCATED OUTSIDE BUILDING DRIPLINES AND ROOF VALLEY POINTS OF CONCENTRATION TO PREVENT DAMAGE TO PLANTS. CLARIFY DISCREPANCIES WITH LANDSCAPE ARCHITECT PRIOR TO INSTALLATION.
16. ALL DISTURBED AREAS NOT TO BE PAVED OR OTHERWISE TREATED, WILL RECEIVE SIX (6) INCH LOAM AND SEED AT THE DIRECTION OF THE LANDSCAPE ARCHITECT OR OWNER'S REPRESENTATIVE.
17. TREE STAKES AND WRAP WILL REMAIN IN PLACE FOR NO LESS THAN 6 MONTHS AND NO MORE THAN 1 YEAR. CONTRACTOR WILL REMOVE.
18. ALL PLANT GROUPINGS WILL BE IN MULCH BEDS UNLESS OTHERWISE SPECIFIED OR NOTED ON PLANS. WHERE MULCHED PLANT BED ABUTS LAWN, PROVIDE TURF CUT EDGE.
19. ALL PLANT BEDS WILL INTERSECT WITH PAVEMENT AT 90 DEGREES UNLESS OTHERWISE NOTED ON PLANS.

LANDSCAPE GUARANTEE AND MAINTENANCE NOTES

1. CONTRACTOR WILL BE RESPONSIBLE FOR ALL MEANS, METHODS AND TECHNIQUES OF WATERING.
2. CONTRACTOR WILL BEGIN WATERING IMMEDIATELY AFTER PLANTING. ALL PLANTS WILL BE THOROUGHLY WATERED TWICE DURING THE FIRST 24 HOUR PERIOD AFTER PLANTING. ALL PLANTS WILL BE WATERED WEEKLY, OR MORE OFTEN, IF NECESSARY DURING THE FIRST GROWING SEASON BUT NOT LESS THAN ONE YEAR.
3. WATER ALL LAWNS AS REQUIRED. DO NOT LET NEWLY PLANTED LAWNS DRY OUT DURING THE FIRST FOUR WEEKS MINIMUM.
4. ALL NEW LAWNS WILL BE MAINTAINED AND MOWED A MINIMUM THREE (3) TIMES BEFORE REQUESTING REVIEW BY LANDSCAPE ARCHITECT OR OWNER'S REPRESENTATIVE FOR ACCEPTANCE. MAINTENANCE AND MOWING WILL CONTINUE UNTIL ACCEPTED BY LANDSCAPE ARCHITECT OR OWNERS' REPRESENTATIVE IS ISSUED IN WRITING.
5. THE CONTRACTOR WILL MAINTAIN AND GUARANTEE ALL PLANTINGS TO BE IN GOOD HEALTHY, FLOURISHING AND ACCEPTABLE CONDITION FOR A PERIOD OF ONE (1) YEAR BEGINNING AT THE DATE OF ACCEPTANCE BY THE LANDSCAPE ARCHITECT OR OWNER'S REPRESENTATIVE. ALL GRASSES, TREES AND SHRUBS THAT, IN THE OPINION OF THE LANDSCAPE ARCHITECT OR OWNER'S REPRESENTATIVE SHOWING LESS THAN 80% HEALTHY GROWTH AT THE END OF ONE (1) YEAR PERIOD WILL BE IMMEDIATELY REPLACED BY THE CONTRACTOR.
6. DECIDUOUS PLANT MATERIAL INSTALLED AFTER SEPTEMBER 30 AND BEFORE APRIL 15 WILL NOT BE REVIEWED THAT SEASON FOR ACCEPTANCE DUE TO STAGE OF LEAF PHYSIOLOGY. THIS PLANT MATERIAL WILL NOT BE REVIEWED UNTIL FOLLOWING GROWING SEASON. GUARANTEE PERIOD WILL BEGIN ONLY AFTER ACCEPTANCE BY LANDSCAPE ARCHITECT OR OWNERS' REPRESENTATIVE.
7. EVERGREEN PLANT MATERIAL INSTALLED AFTER OCTOBER 30 AND BEFORE APRIL 15 WILL NOT BE REVIEWED THAT SEASON FOR ACCEPTANCE DUE TO END OF GROWTH SEASON. THIS PLANT MATERIAL WILL NOT BE REVIEWED UNTIL FOLLOWING GROWING SEASON. GUARANTEE PERIOD WILL BEGIN ONLY AFTER ACCEPTANCE BY LANDSCAPE ARCHITECT OR OWNERS' REPRESENTATIVE.

HYDROSEEDING NOTES

1. HYDROSEEDING MAY BE USED AS AN ALTERNATE METHOD OF SEEDING. THE APPLICATION OF LIMESTONE AS NECESSARY, FERTILIZER AND GRASS SEED MAY BE ACCOMPLISHED IN ONE OPERATION BY THE USE OF A SPRAYING MACHINE APPROVED BY THE LANDSCAPE ARCHITECT OR CIVIL ENGINEER. THE MATERIALS SHALL BE MIXED WITH WATER IN THE MACHINE AND SHALL CONFORM TO RELATIVE REQUIREMENTS OF SECTION 644 OF NH. STANDARD SPECIFICATIONS FOR ROAD AND BRIDGE CONSTRUCTION.
2. (FOR MASSACHUSETTS PROJECTS PLUG IN - SECTION 765.65 OF MASS. DPW CURRENT STANDARD SPECIFICATIONS FOR HIGHWAYS AND BRIDGES).

INVASIVE PLANT NOTES

1. EXISTING NON-NATIVE, INVASIVE PLANT SPECIES WILL BE IDENTIFIED, REMOVED, DESTROYED AND LEGALLY DISPOSED OF OFF-SITE IN ACCORDANCE WITH THE LATEST UNIVERSITY OF NEW HAMPSHIRE COOPERATIVE EXTENSION METHODS OF DISPOSING NON-NATIVE INVASIVE PLANTS. SEE "MANAGE AND CONTROL INVASIVES" AND PROPERLY DISPOSE OF INVASIVE PLANTS".

PRICING & CONSTRUCTION DOCUMENT NOTES

1. CONTRACTOR WILL PRICE PLANT MATERIAL IN QUANTITIES SUFFICIENT TO COMPLETE PLANTINGS GRAPHICALLY SHOWN ON THESE DRAWINGS OR IN PLANT LIST, WHICHEVER IS GREATER. IN CASES OF DISCREPANCY BETWEEN PLAN AND LIST CLARIFY WITH LANDSCAPE ARCHITECT PRIOR TO PLACING PURCHASE ORDER AND AGAIN PRIOR TO PLANTING.
2. CONTRACTOR WILL VERIFY PRIOR TO PRICING IF SITE SOILS ARE VERY POORLY DRAINING OR IF LEDGE IS PRESENT. IF CONTRACTOR ENCOUNTERS VERY POORLY DRAINING SOILS (BATH TUB EFFECT) OR LEDGE THAT IMPACTS PROPOSED PLANTING PLAN, NOTIFY LANDSCAPE ARCHITECT OR OWNERS' REPRESENTATIVE FOR DIRECTION PRIOR TO PRICING AND AGAIN PRIOR TO PERFORMING ANY WORK.
3. CONTRACTOR WILL STAKE OR PLACE ON GROUND ALL PROPOSED PLANT MATERIALS PER PLAN. CONTACT LANDSCAPE ARCHITECT FOR REVIEW AND APPROVAL PRIOR TO INSTALLATION.
4. COORDINATE WITH LANDSCAPE ARCHITECT'S CONTRACTED NUMBER OF SITE VISITS WHEN PLANNING FOR INSPECTION. NOTIFY LANDSCAPE ARCHITECT 72 HOURS MINIMUM IN ADVANCE OF REQUESTED SITE VISIT.
5. CONTRACTOR WILL DEVELOP A WRITTEN WATERING SCHEDULE AND WILL SUBMIT WATERING SCHEDULE TO OWNERS' REPRESENTATIVE. CONTRACTOR WILL WATER ALL NEW PLANTS INCLUDING LAWNS THAT ARE NOT "IRRIGATED" VIA A PERMANENT IRRIGATION SYSTEM FOR THE FIRST 12 MONTHS.

PORTSMOUTH NOTES

1. THE PROPERTY OWNER AND ALL FUTURE PROPERTY OWNER'S WILL BE RESPONSIBLE FOR THE MAINTENANCE AND OF ALL REQUIRED SCREENING AND LANDSCAPE MATERIALS INDICATED ON THESE PLANS.
2. ALL REQUIRED PLANT MATERIAL WILL BE TENDED TO AND KEPT FREE OF REFUSE AND DEBRIS.
3. ALL REQUIRED FENCES AND WALLS WILL BE MAINTAINED IN GOOD REPAIR.
4. THE PROPERTY OWNER WILL BE RESPONSIBLE TO REMOVE AND REPLACE DEAD OR DISEASED PLANT MATERIALS IMMEDIATELY WITH THE SAME TYPE, SIZE AND QUANTITY OF PLANT MATERIALS AS ORIGINALLY INSTALLED. UNLESS ALTERNATIVE PLANTINGS ARE REQUESTED, JUSTIFIED AND APPROVED BY THE PLANNING BOARD OR PLANNING DIRECTOR.
5. ALL IMPROVEMENTS SHOWN ON THIS PLAN WILL BE CONSTRUCTED AND MAINTAINED IN ACCORDANCE WITH THIS PLAN BY THE PROPERTY OWNER AND ALL FUTURE PROPERTY OWNERS. NO CHANGES WILL BE MADE TO THIS PLAN WITHOUT THE WRITTEN APPROVAL OF THE PORTSMOUTH PLANNING BOARD OR PLANNING DIRECTOR.
6. THE LANDSCAPE PLAN WILL BE RECORDED IN THE ROCKINGHAM COUNTY REGISTRY OF DEEDS.
7. THIS SITE PLAN SHALL BE RECORDED IN THE ROCKINGHAM COUNTY REGISTRY OF DEEDS.
8. ALL IMPROVEMENTS SHOWN ON THIS SITE PLAN SHALL BE CONSTRUCTED AND MAINTAINED IN ACCORDANCE WITH THE PLAN BY THE PROPERTY OWNER AND ALL FUTURE PROPERTY OWNERS. NO CHANGES SHALL BE MADE TO THIS SITE PLAN WITHOUT THE EXPRESS APPROVAL OF THE PORTSMOUTH PLANNING DIRECTOR.

SEEDING NOTES

1. SLOPES UP TO AND INCLUDING 3:1 GRADE, SEED WILL BE NEW ENGLAND EROSION CONTROL & RESTORATION MIX PER NEW ENGLAND WETLANDS PLANTS INC., AMHERST, MA.
2. SLOPES STEEPER THAN 3:1 GRADE, SEED WILL BE NEW ENGLAND EROSION CONTROL & RESTORATION MIX PER NEW ENGLAND WETLANDS PLANTS INC., AMHERST, MA. SEE CIVIL FOR ADDITIONAL EROSION CONTROL MEASURES.
3. GENERAL SEED WILL BE NHDOT SPECIFICATION SECTION 644, TABLE 644-1-PARK SEED TYPE 15, INCLUDING NOTES TO TABLE 1, 2 & 3.



SITE DEVELOPMENT PLANS

TAX MAP 256 LOT 2
OVERALL LANDSCAPE PLAN
THE VILLAGE AT BANFIELD WOODS
PORTSMOUTH, NH

OWNED BY
WALTER D HETT TRUST
 PREPARED FOR
GREEN & COMPANY REAL ESTATE
1"=120' (11"X17")
SCALE: 1"=60' (22"X34") **SEPTEMBER 25, 2019**

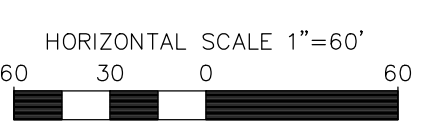

REV	DATE	DESCRIPTION	DR	CK
6	5/5/2020	REVISE NOTE PER CLIENT REQUEST	MSK	JJM
1	12/23/19	NO REVISIONS THIS SHEET	RCK	JJM

TFM	Civil Engineers Structural Engineers Traffic Engineers Land Surveyors Landscape Architects Scientists			48 Constitution Drive Bedford, NH 03110 Phone (603) 472-4488 Fax (603) 472-9747 www.tfmoran.com
	47361.00	DR MSK CK JUM	FB CADFILE	LANDSCAPE
				C-16

May 14, 2020 - 12:04pm F:\MISC Projects\47361 - Portsmouth\47361-00 - Green & Co - Banfield Road\Design\Production Drawings\Landscape.dwg

Copyright 2019 © Thomas F. Moran, Inc.
 48 Constitution Drive, Bedford, N.H. 03110
 All rights reserved. These plans and materials may not be copied, duplicated, replicated or otherwise reproduced in any form whatsoever without the prior written permission of Thomas F. Moran, Inc.
 This plan is not effective unless signed by a duly authorized officer of Thomas F. Moran, Inc.



MATCHLINE

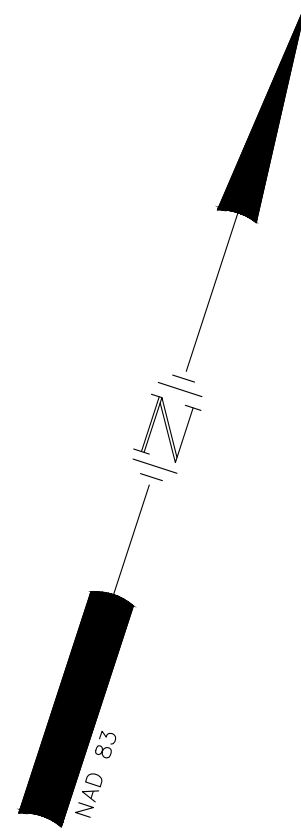
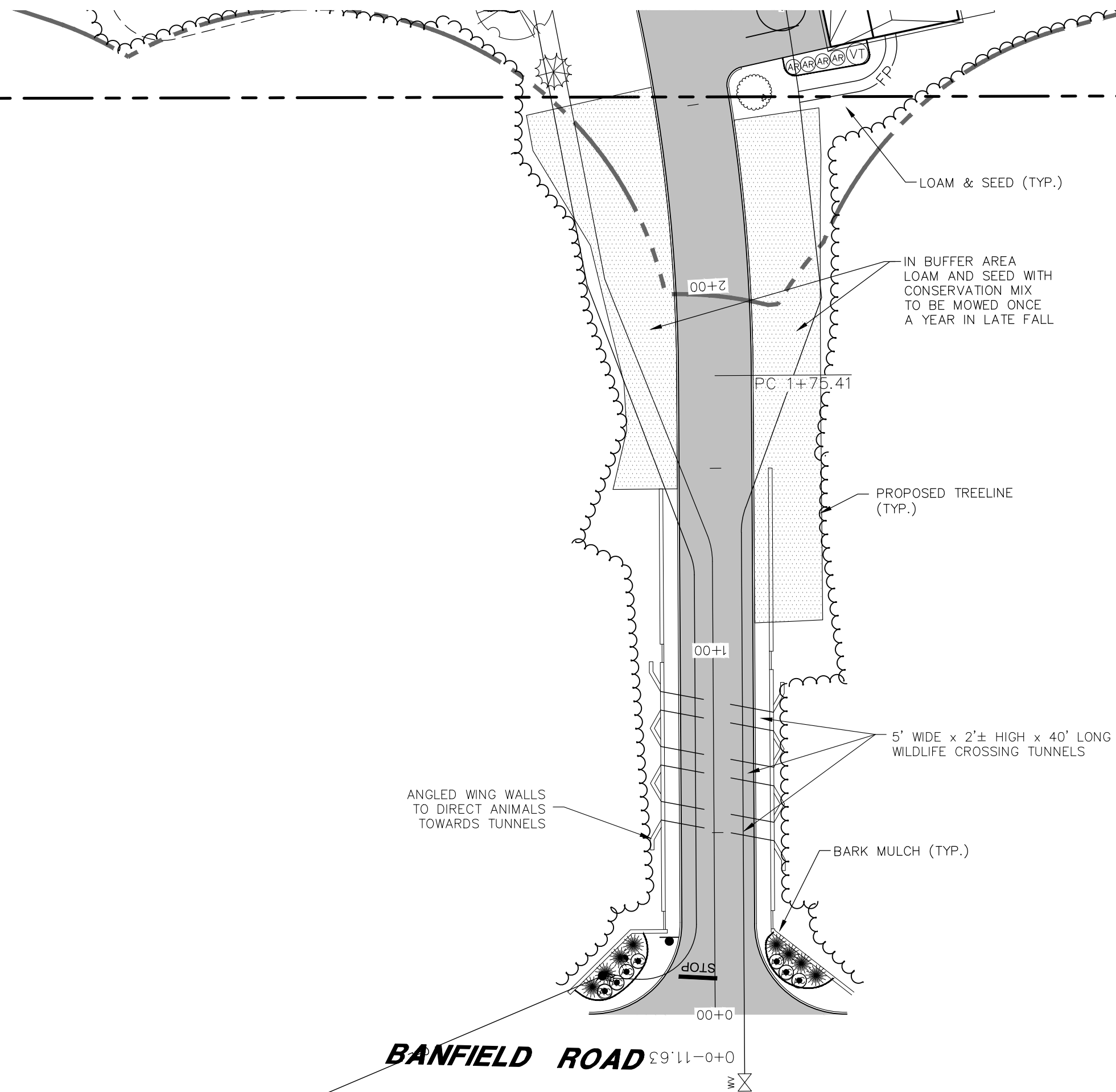

LANDSCAPE LEGEND

SYMBOL	QTY	BOTANICAL NAME COMMON NAME	SIZE	REMARKS
SHADE TREES				
	12	ACER RUBRUM 'OCTOBER GLORY' **OCTOBER GLORY RED MAPLE	3" TO 3 1/2" CAL.	B&B
	10	ACER SACCHARUM 'COMMEMORATION' **COMMEMORATION SUGAR MAPLE	3" TO 3 1/2" CAL.	B&B
	20	BETULA N. 'HERITAGE' *RIVER BIRCH	12' TO 14' CLUMP	B&B
	20	NYSSA SYLVATICA *BLACK GUM	2 1/2 TO 3" CAL.	B&B
	12	QUERCUS ALBA *WHITE OAK	3" TO 3 1/2" CAL.	B&B
	11	QUERCUS RUBRA *RED OAK	3" TO 3 1/2" CAL.	B&B

LANDSCAPE LEGEND

SYMBOL	QTY	BOTANICAL NAME COMMON NAME	SIZE	REMARKS
SMALL/FLOWERING TREES				
	8	CARPINUS CAROLINIANA *AMERICAN HORNBEAM	2' TO 2 1/2" CAL.	B&B
	36	CRATAEGUS CRUGALLI INERMIS **THORNLESS COCKSPUR HAWTHORN	2 1/2" TO 3" CAL.	B&B
	22	PRUNUS VIRGINIANA 'SCHUBERT' *CANADA RED CHERRY	2 1/2" TO 3" CAL.	B&B
EVERGREEN TREES				
	17	ABIES BALSAMAE *BALSAM FIR	6' TO 7'	B&B
	11	JUNIPERUS VIRGINIANA *EASTERN RED CEDAR	6' TO 7'	B&B
	35	PICEA GLAUCA *WHITE SPRUCE	7' TO 8'	B&B
	23	PINUS STROBUS *WHITE PINE	6' TO 7'	B&B

LANDSCAPE LEGEND

SYMBOL	QTY	BOTANICAL NAME COMMON NAME	SIZE	REMARKS
DECIDUOUS SHRUB				
	24	AMELANCHEIR CANADENSIS *SHADBLow SERVICEBERRY	5' TO 6' CLUMP	B&B
	33	CLETHRA ALNIFOLIA 'COMPACTA' **COMPACT SUMMERSWEET	7 GAL.	CONT.
	51	CORNUS SERICEA 'ALLEMAN'S COMPACTA' **ALLEMAN'S COMPACT RED-OSIER DOGWOOD	3' TO 4'	CONT.
	48	PHYSOCARPUS O. 'BURGUNDY CANDY' **BURGUNDY CANDY NINEBARK	2 GAL.	CONT.
	14	VIBURNUM DENTATUM *ARROWWOOD VIBURNUM	4' TO 5'	B&B
	17	VIBURNUM TRILOBUM *AMERICAN CRANBERRY VIBURNUM	4' TO 5'	B&B
	3	VIBURNUM PRUNIFOLIUM *BLACKHAW VIBURNUM	4' TO 5'	B&B

LANDSCAPE LEGEND

SYMBOL	QTY	BOTANICAL NAME COMMON NAME	SIZE	REMARKS
EVERGREEN SHRUB				
	23	ARCTOSTAPHYLOS UVA-URSI *BEARBERRY	1 GAL.	CONT.
	26	AZALEA 'GIRARD'S CRIMSON' GIRARD'S CRIMSON AZALEA	3 GAL.	CONT.
	26	AZALEA 'GIRARD'S RENEE MICHELE' GIRARD'S RENEE MICHELE AZALEA	3 GAL.	CONT.
	30	RHODODENDRON 'ROSEUM PINK' **ROSEUM PINK CATAWBA RHODODENDRON	7 GAL.	CONT.
	20	ILEX GLABRA 'COMPACTA' **COMPACT INKBERRY	3 GAL.	CONT.
	25	JUNIPERUS H. 'BAR HARBOR' *BAR HARBOR JUNIPER	3 GAL.	CONT.
	121	JUNIPERUS C. 'ANGELICA BLUE' ANGELICA BLUE JUNIPER	5 GAL.	CONT.
	14	PINUS M. 'MOPS' MOPS MUGO PINE	3 GAL.	CONT.
	65	THUJA O. NIGRA *DARK AMERICAN ARBORVITAE	5' TO 6'	B&B

SYMBOL	QTY	BOTANICAL NAME COMMON NAME	SIZE	REMARKS
GRASSES AND GRASS MIXES				
	11	PANICUM VIRGATUM 'CLOUD NINE' CLOUD NINE SWITCH GRASS	3 GAL.	CONT.
	3 LBS	NEW ENGLAND CONSERVATION WILDLIFE MIX	25 LBS/ACRE	BULK LBS

*NATIVE
**IMPROVED NATIVE
NOTE:
PLANT TYPES MAY VARY BASED ON AVAILABILITY AND SUPPLY. THIS LAYOUT REPRESENTS THE INTENT OF THE PLANTINGS AND APPROXIMATE NUMBERS OF PLANTS TO BE PROVIDED.

NOTES

- THIS SITE PLAN SHALL BE RECORDED IN THE ROCKINGHAM COUNTY REGISTRY OF DEEDS.
- ALL IMPROVEMENTS SHOWN ON THIS SITE PLAN SHALL BE CONSTRUCTED AND MAINTAINED IN ACCORDANCE WITH THE PLAN BY THE PROPERTY OWNER AND ALL FUTURE PROPERTY OWNERS. NO CHANGES SHALL BE MADE TO THIS SITE PLAN WITHOUT THE EXPRESS APPROVAL OF THE PORTSMOUTH PLANNING DIRECTOR.

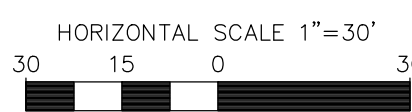

REV	DATE	DESCRIPTION	DR	CK
6	5/5/2020	REVISE NOTE PER CLIENT REQUEST	MSK	JJM
3	3/4/2020	UPDATE PLANS PER REGULATORY COMMENTS	RCK	JJM
2	12/27/2019	IN HOUSE REVISIONS	RCK	JJM
1	12/23/19	NO REVISIONS THIS SHEET	RCK	JJM

SITE DEVELOPMENT PLANS

TAX MAP 256 LOT 2
LANDSCAPE PLAN
THE VILLAGE AT BANFIELD WOODS
PORTSMOUTH, NH

OWNED BY
WALTER D HETT TRUST

PREPARED FOR

GREEN & COMPANY REAL ESTATE

1"=60' (11"X17")

SCALE: 1"=30' (22"X34")

SEPTEMBER 25, 2019



Civil Engineers
Structural Engineers
Traffic Engineers
Land Surveyors
Landscape Architects
Scientists

48 Constitution Drive
Bedford, NH 03110
Phone (603) 472-4488
Fax (603) 472-9747
www.tfmoran.com

FILE	47361.00	DR	MSK	FB			
		CK	JJM	CADFILE	LANDSCAPE		C-17

May 14, 2020 - 12:04pm F:\MSC Projects\47361 - Banfield Road - Portsmouth\47361-00 - Green & Co - Banfield Road\Design\Production Drawings\Landscape.dwg

Copyright 2019 © Thomas F. Moran, Inc.
48 Constitution Drive, Bedford, N.H. 03110
All rights reserved. These plans and materials may not be copied, duplicated, replicated or otherwise reproduced in any form whatsoever without the prior written permission of Thomas F. Moran, Inc.
This plan is not effective unless signed by a duly authorized officer of Thomas F. Moran, Inc.



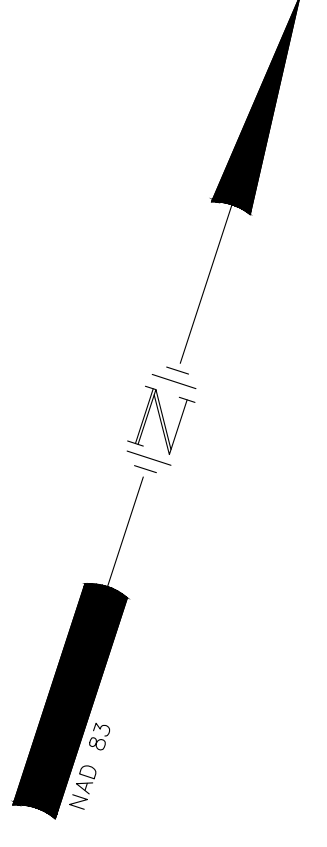

- NOTES**
1. THIS SITE PLAN SHALL BE RECORDED IN THE ROCKINGHAM COUNTY REGISTRY OF DEEDS.
 2. ALL IMPROVEMENTS SHOWN ON THIS SITE PLAN SHALL BE CONSTRUCTED AND MAINTAINED IN ACCORDANCE WITH THE PLAN BY THE PROPERTY OWNER AND ALL FUTURE PROPERTY OWNERS. NO CHANGES SHALL BE MADE TO THIS SITE PLAN WITHOUT THE EXPRESS APPROVAL OF THE PORTSMOUTH PLANNING DIRECTOR.



SITE DEVELOPMENT PLANS
 TAX MAP 256 LOT 2
LANDSCAPE PLAN
THE VILLAGE AT BANFIELD WOODS
 PORTSMOUTH, NH
 OWNED BY
WALTER D HETT TRUST
 PREPARED FOR
GREEN & COMPANY REAL ESTATE
 1"=60' (11"X17")
 SCALE: 1"=30' (22"X34") SEPTEMBER 25, 2019

Copyright 2019 © Thomas F. Moran, Inc.
 48 Constitution Drive, Bedford, N.H. 03110
 All rights reserved. These plans and materials may not be copied, duplicated, replicated or otherwise reproduced in any form whatsoever without the prior written permission of Thomas F. Moran, Inc.
 This plan is not effective unless signed by a duly authorized officer of Thomas F. Moran, Inc.

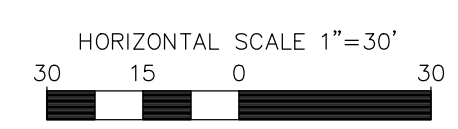

REV	DATE	DESCRIPTION	DR	CK
6	5/5/2020	REVISE NOTE PER CLIENT REQUEST	MSK	JJM
3	3/4/2020	UPDATE PLANS PER REGULATORY COMMENTS	RCK	JJM
2	12/27/2019	IN HOUSE REVISIONS	RCK	JJM
1	12/23/19	NO REVISIONS THIS SHEET	RCK	JJM

TFM	Civil Engineers	48 Constitution Drive
	Structural Engineers	Bedford, NH 03110
	Traffic Engineers	Phone (603) 472-4488
	Land Surveyors	Fax (603) 472-9747
	Landscape Architects	www.tfmoran.com
	Scientists	

FILE NO: 47361.00	DR: MSK	FB	
CK: JJM	CADFILE	LANDSCAPE	C-18

May 14, 2020 - 12:04pm F:\MSC Projects\47361 - Portsmouth\47361-00 - Green & Co - Banfield Road\Design\Production Drawings\Landscape.dwg

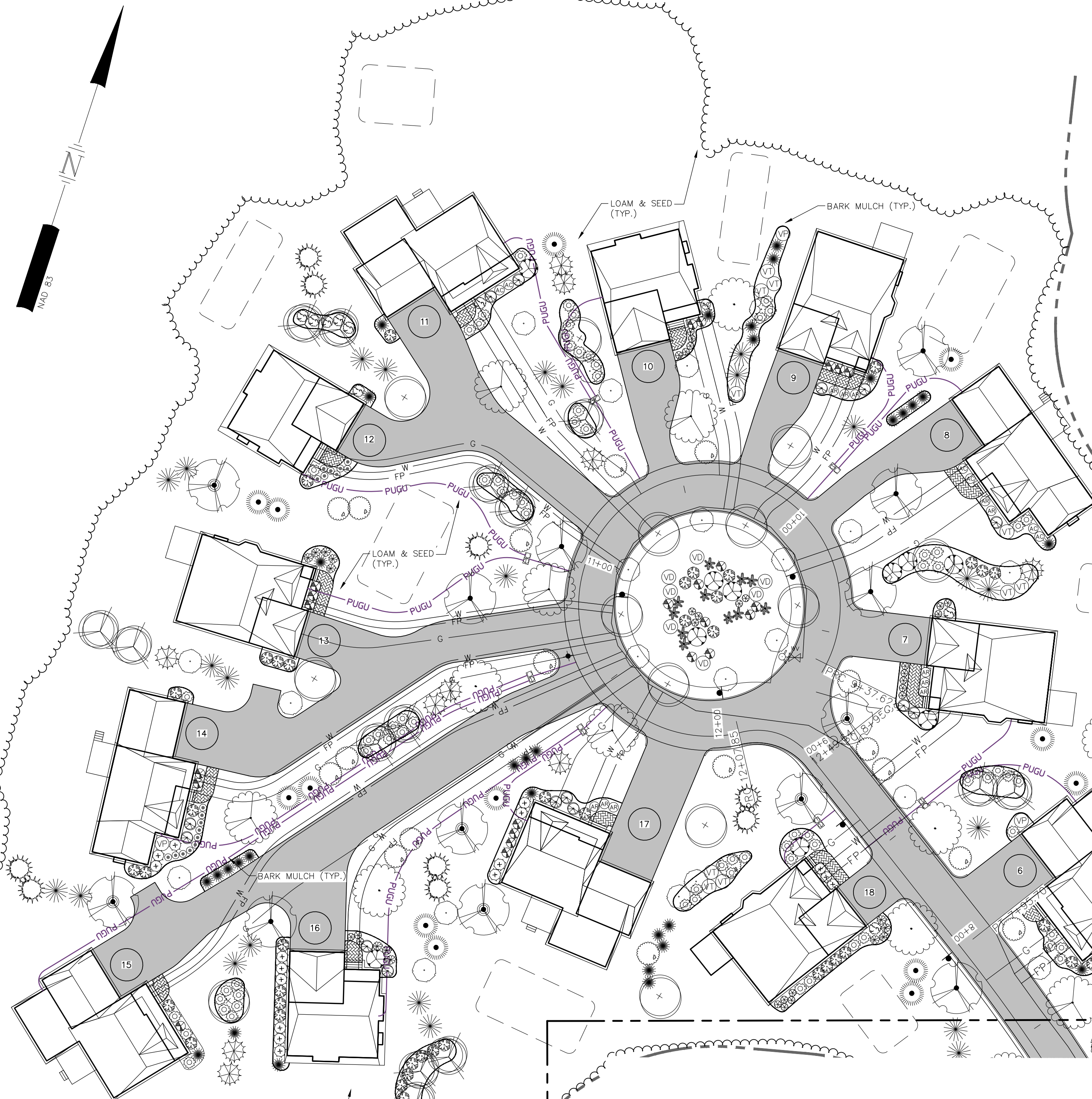

Copyright 2019 © Thomas F. Moran, Inc.
 48 Constitution Drive, Bedford, N.H. 03110

All rights reserved. These plans and materials may not be copied, duplicated, replicated or otherwise reproduced in any form whatsoever without the prior written permission of Thomas F. Moran, Inc.

This plan is not effective unless signed by a duly authorized officer of Thomas F. Moran, Inc.

DIG SAFE

CONTACT DIG SITE 72 BUSINESS HOURS PRIOR TO CONSTRUCTION

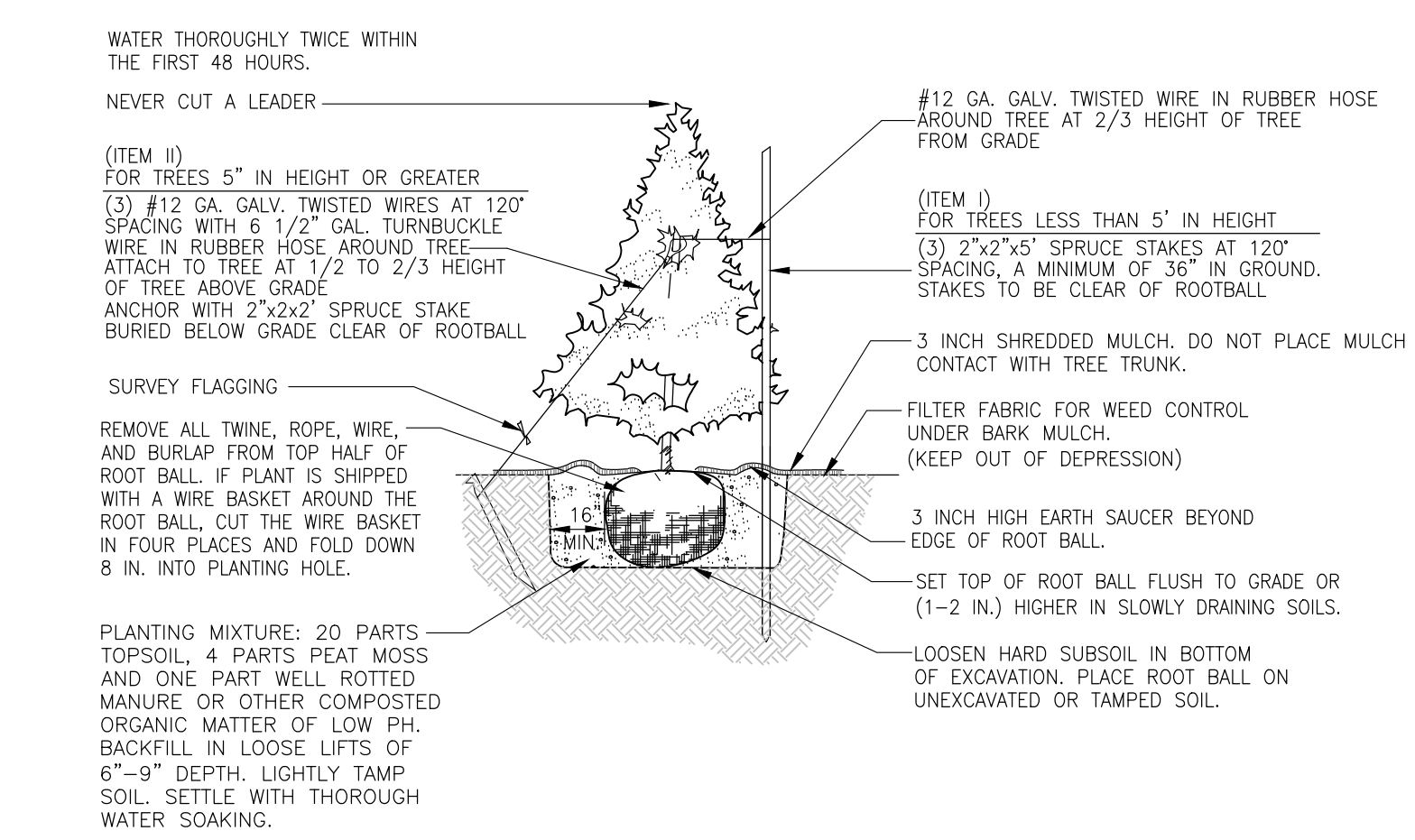
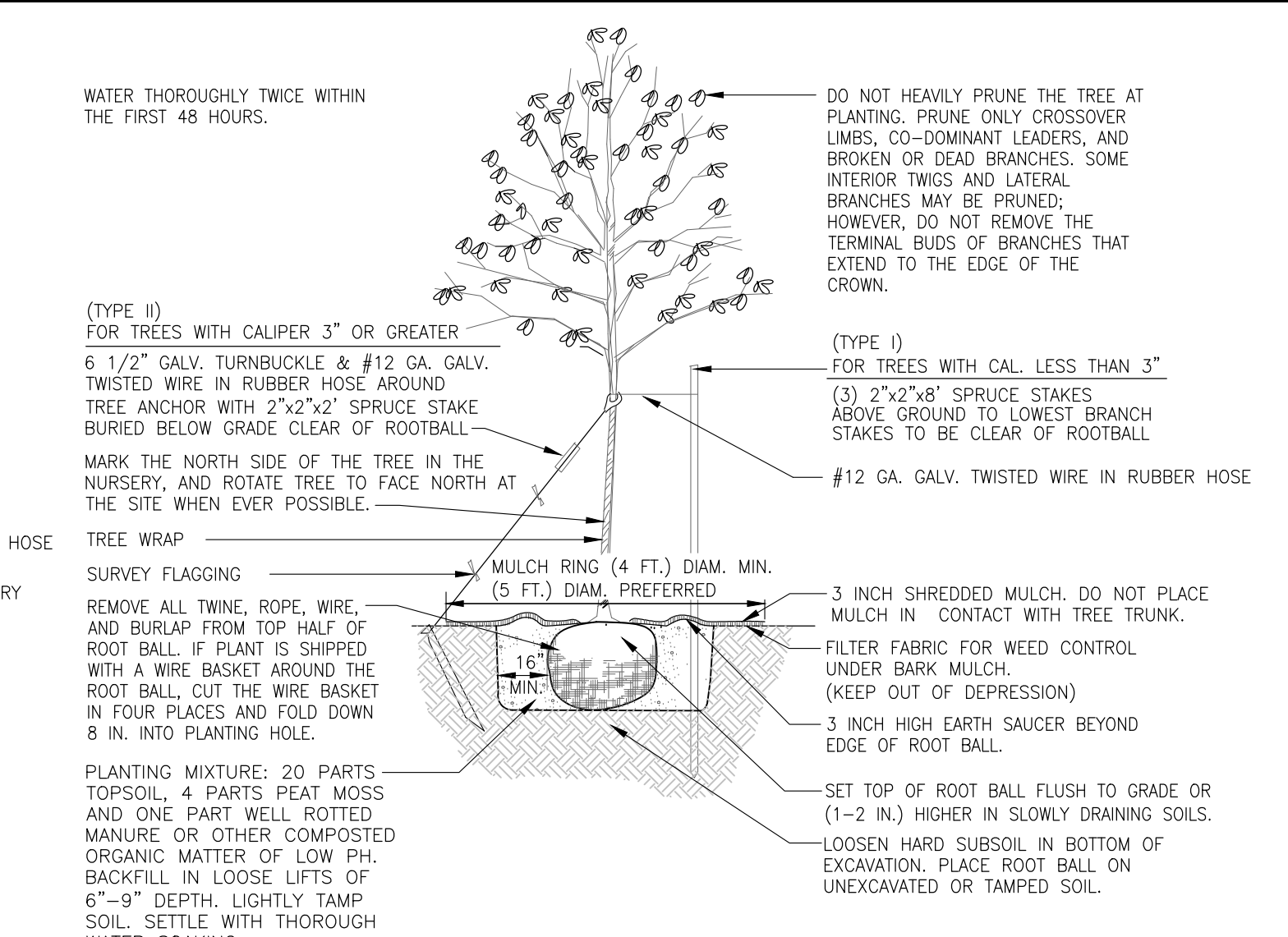
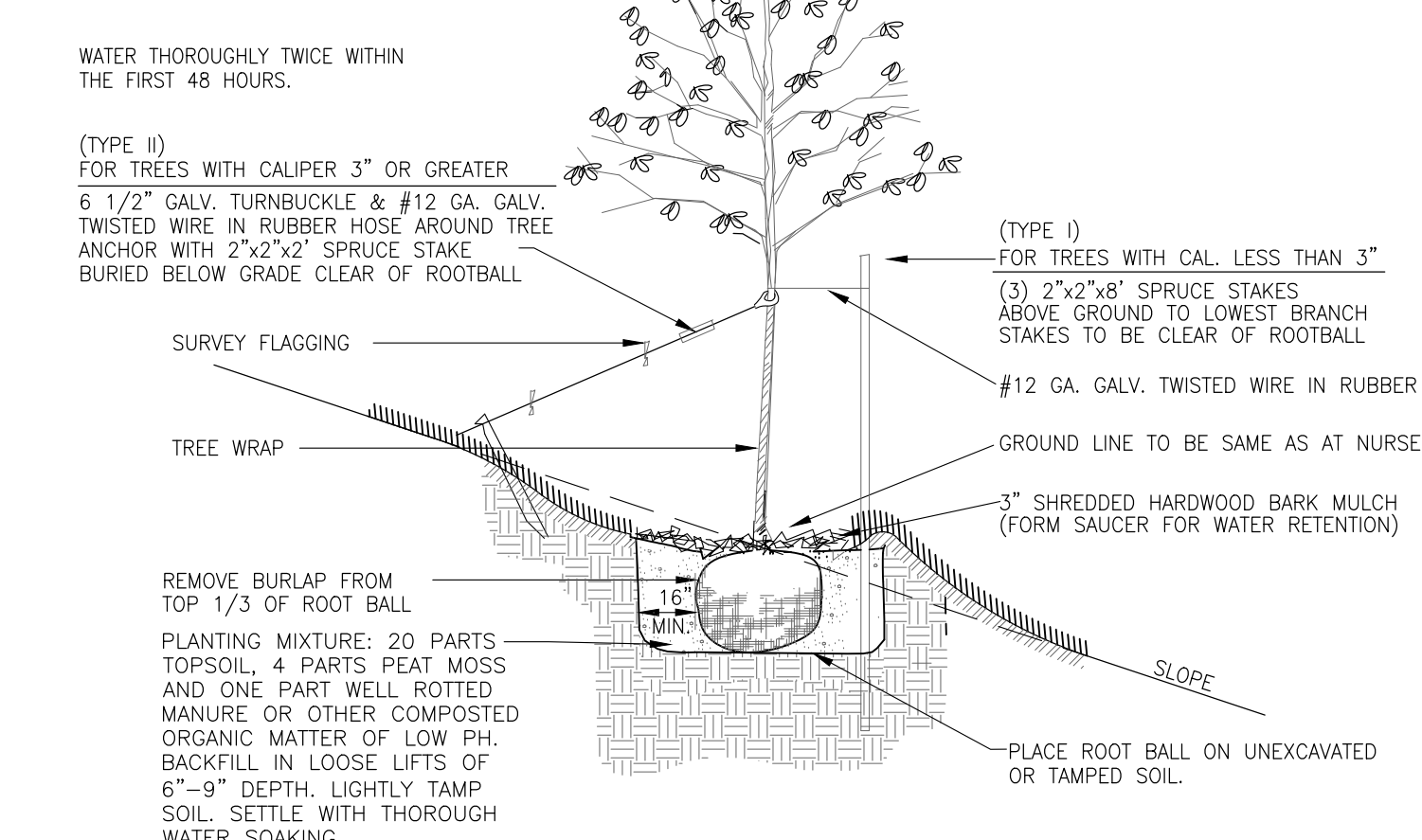
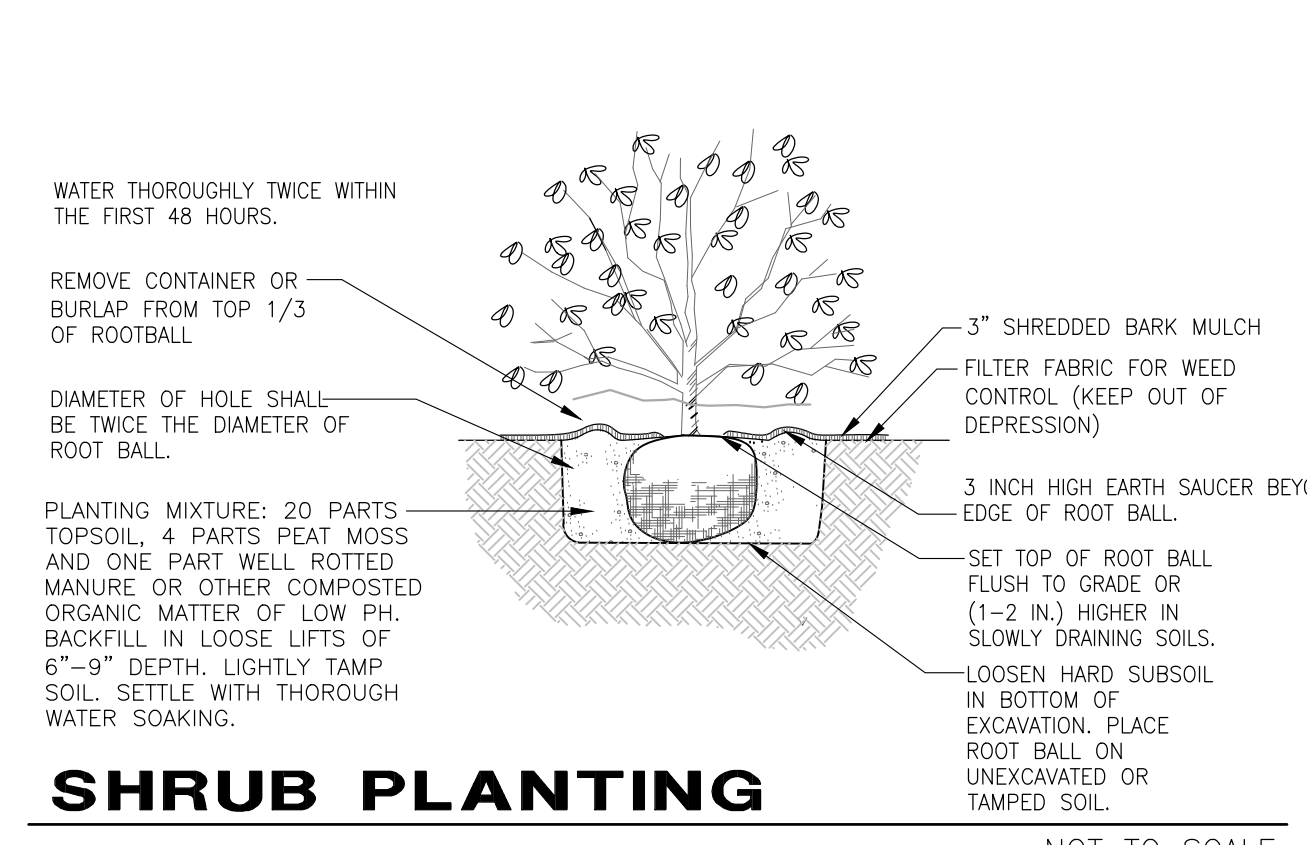
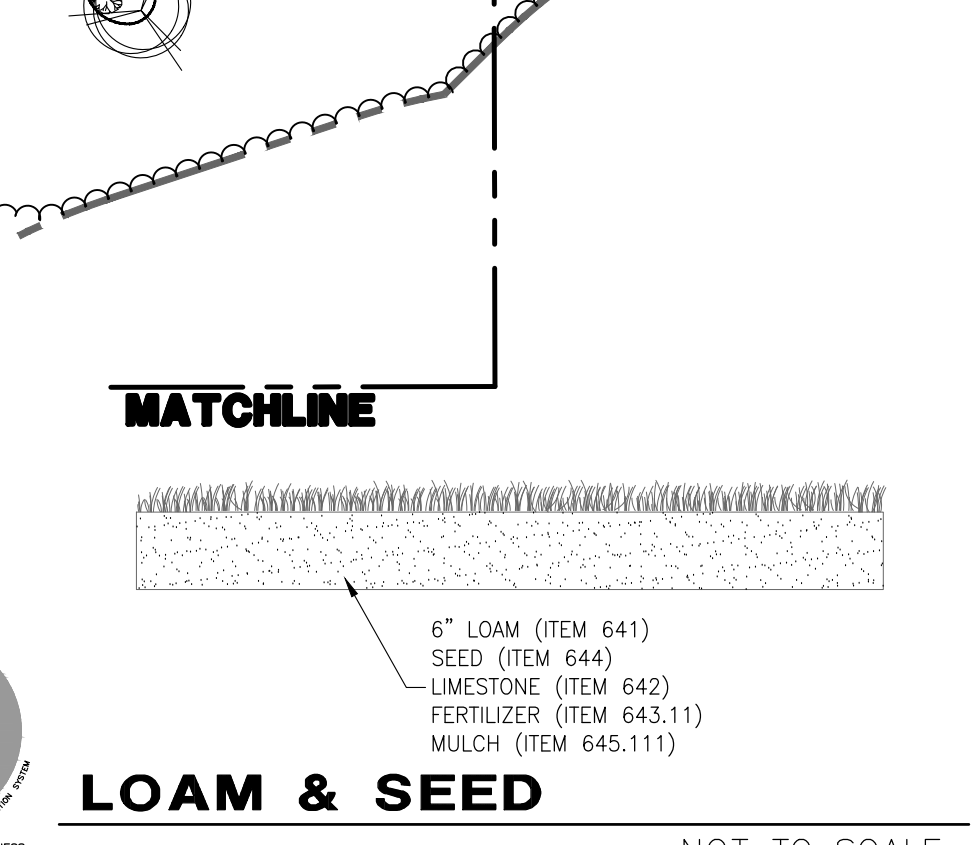

NOTES

1. THIS SITE PLAN SHALL BE RECORDED IN THE ROCKINGHAM COUNTY REGISTRY OF DEEDS.
2. ALL IMPROVEMENTS SHOWN ON THIS SITE PLAN SHALL BE CONSTRUCTED AND MAINTAINED IN ACCORDANCE WITH THE PLAN BY THE PROPERTY OWNER AND ALL FUTURE PROPERTY OWNERS. NO CHANGES SHALL BE MADE TO THIS SITE PLAN WITHOUT THE EXPRESS APPROVAL OF THE PORTSMOUTH PLANNING DIRECTOR.

MATCHLINE



SITE DEVELOPMENT PLANS

TAX MAP 256 LOT 2
LANDSCAPE PLAN
THE VILLAGE AT BANFIELD WOODS
PORTSMOUTH, NH

OWNED BY
WALTER D HETT TRUST
 PREPARED FOR
GREEN & COMPANY REAL ESTATE
1"=60' (11'X17")
SCALE: 1"=30' (22'X34") **SEPTEMBER 25, 2019**

REV	DATE	DESCRIPTION	DR	CK
6	5/5/2020	REVISE NOTE PER CLIENT REQUEST	MSK	JJM
3	3/4/2020	UPDATE PLANS PER REGULATORY COMMENTS	RCK	JJM
2	12/27/2019	IN HOUSE REVISIONS	RCK	JJM
1	12/23/19	NO REVISIONS THIS SHEET	RCK	JJM

TFM Civil Engineers
 Structural Engineers
 Traffic Engineers
 Land Surveyors
 Landscape Architects
 Scientists

48 Constitution Drive
 Bedford, NH 03110
 Phone (603) 472-4488
 Fax (603) 472-9747
 www.tfmoran.com

747361.00 DR MSK FB
 CK JUM CADFILE LANDSCAPE

C-19

May 14, 2020 - 12:04pm
 F:\MISC Projects\47361 - Portsmouth\47361-00 - Green & Co - Banfield Road\Design\Production Drawings\landscape.dwg

May 14, 2020 - 12:04pm
F:\MISC Projects\47361 - Portsmouth\47361-10 - Green & Co - Banfield Road\Design\Production Drawings\Lighting.dwg

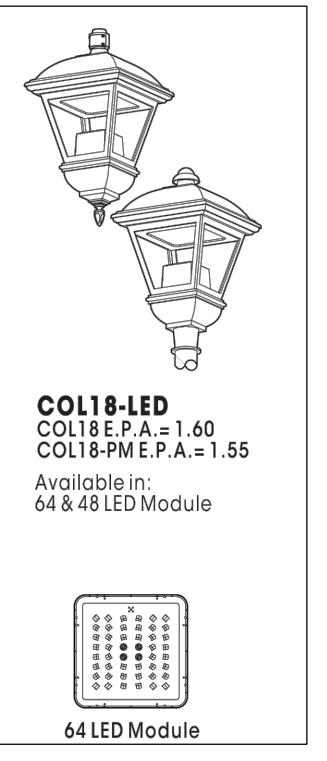
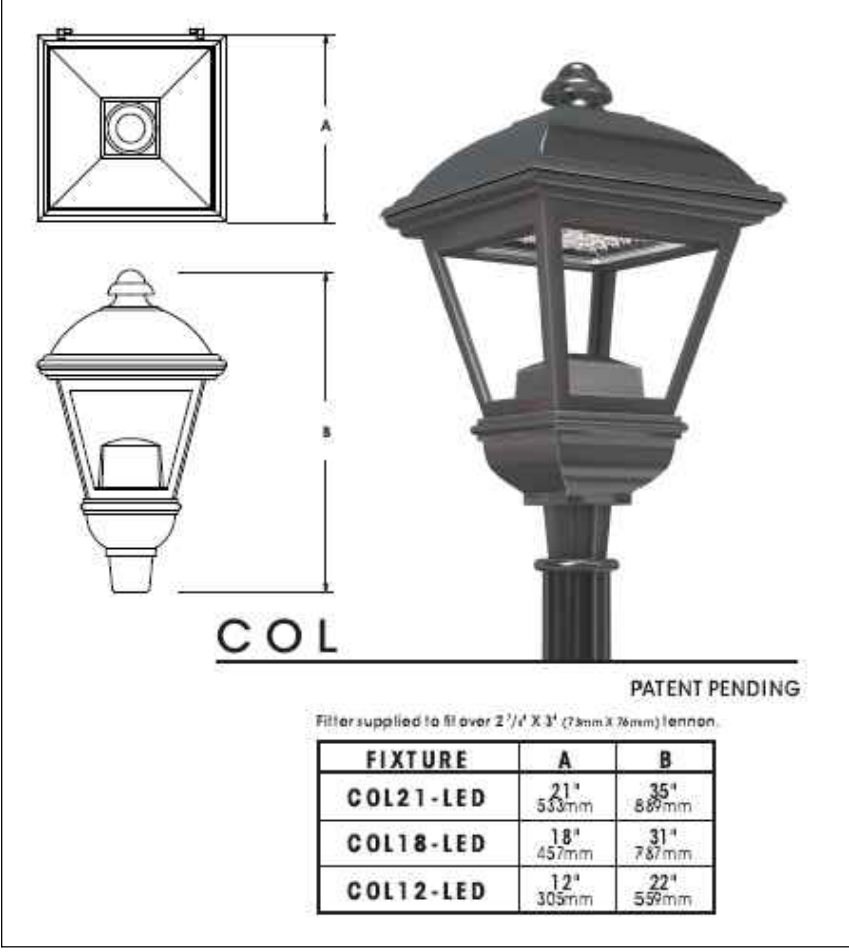

NOTES
1. PROPOSED ROADWAY LIGHTING SHALL BE DARK SKY FRIENDLY.

SITE DEVELOPMENT PLANS
TAX MAP 256 LOT 2
LIGHTING PLAN
THE VILLAGE AT BANFIELD WOODS
PORTSMOUTH, NH
OWNED BY
WALTER D HETT TRUST
PREPARED FOR
GREEN & COMPANY REAL ESTATE
(11"X17")
SCALE: (22"X34") **SEPTEMBER 25, 2019**

Symbol	Qty	Label	Arrangement	Description
☒	2	P3	SINGLE	COL18-III-48VLED-NW-350-HS-PT/ MOUNTED ON 12' WOOD POLE PROVIDED BY OTHERS
☒	6	P4	SINGLE	COL18-IV-48VLED-NW-350-HS-PT/ MOUNTED ON 12' WOOD POLE PROVIDED BY OTHERS

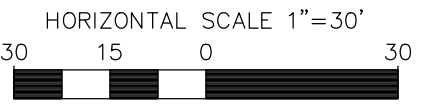

REV	DATE	DESCRIPTION	DR	CK
6	5/5/2020	AoT SUBMITTAL	RCK	JJM
5	4/29/2020	REVISER PER REGULATORY COMMENTS	RCK	JJM
4	3/20/2020	PROGRESS PRINT	RCK	JJM
3	3/4/2020	UPDATE PLANS PER REGULATORY COMMENTS	RCK	JJM
2	12/27/2019	IN HOUSE REVISIONS	RCK	JJM
1	12/23/19	NO REVISIONS THIS SHEET	RCK	JJM

Copyright 2019 © Thomas F. Moran, Inc.
48 Constitution Drive, Bedford, N.H. 03110
All rights reserved. These plans and materials may not be copied, duplicated, replicated or otherwise reproduced in any form whatsoever without the prior written permission of Thomas F. Moran, Inc.
This plan is not effective unless signed by a duly authorized officer of Thomas F. Moran, Inc.



Civil Engineers
Structural Engineers
Traffic Engineers
Land Surveyors
Landscape Architects
Scientists

48 Constitution Drive
Bedford, NH 03110
Phone (603) 472-4488
Fax (603) 472-9747
www.tfmoran.com

47361.00 DR RCK FB
CK JUM CADFILE LIGHTING C-20A

May 28, 2020 - 12:00pm
F:\MISC Projects\47361 - Portsmouth\47361-00 - Green & Co - Banfield Road\Design\Production Drawings\Lighting.dwg

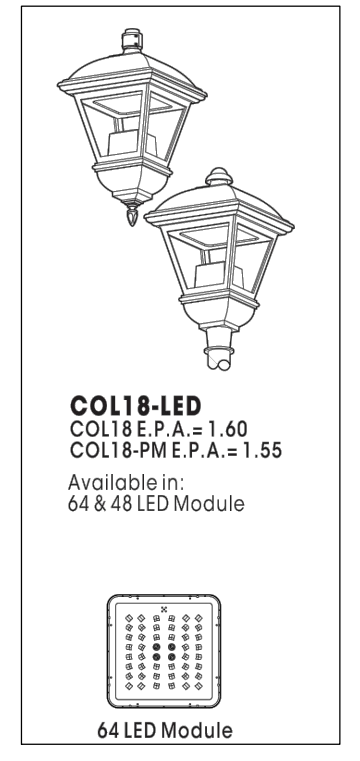
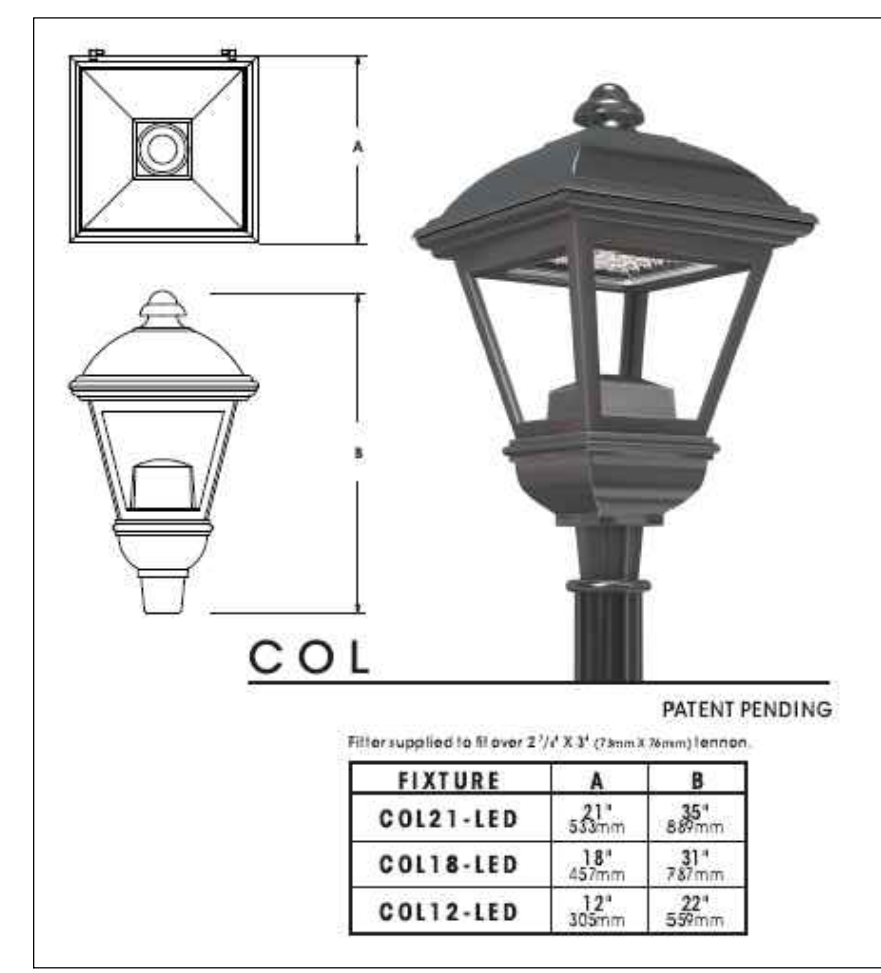

NOTES
1. PROPOSED ROADWAY LIGHTING SHALL BE DARK SKY FRIENDLY.

SITE DEVELOPMENT PLANS
TAX MAP 256 LOT 2
LIGHTING PLAN
THE VILLAGE AT BANFIELD WOODS
PORTSMOUTH, NH
OWNED BY
WALTER D HETT TRUST
PREPARED FOR
GREEN & COMPANY REAL ESTATE
(11"X17")
SCALE: (22"X34") **SEPTEMBER 25, 2019**

Luminaire Schedule				
Symbol	Qty	Label	Arrangement	Description
☒	2	P3	SINGLE	COL18-III-48VLED-NW-350-HS-PT/ MOUNTED ON 12' WOOD POLE PROVIDED BY OTHERS
☒	6	P4	SINGLE	COL18-IV-48VLED-NW-350-HS-PT/ MOUNTED ON 12' WOOD POLE PROVIDED BY OTHERS

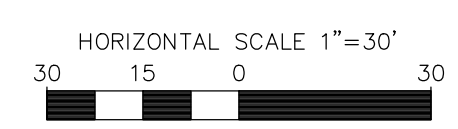

REV	DATE	DESCRIPTION	DR	CK
6	5/5/2020	AoT SUBMITTAL	RCK	JJM
5	4/29/2020	REVISOR PER REGULATORY COMMENTS	RCK	JJM
4	3/20/2020	PROGRESS PRINT	RCK	JJM
3	3/4/2020	UPDATE PLANS PER REGULATORY COMMENTS	RCK	JJM
2	12/27/2019	IN HOUSE REVISIONS	RCK	JJM
1	12/23/19	NO REVISIONS THIS SHEET	RCK	JJM
REV	DATE	DESCRIPTION	DR	CK

Copyright 2019 © Thomas F. Moran, Inc.
48 Constitution Drive, Bedford, N.H. 03110
All rights reserved. These plans and materials may not be copied, duplicated, replicated or otherwise reproduced in any form whatsoever without the prior written permission of Thomas F. Moran, Inc.
This plan is not effective unless signed by a duly authorized officer of Thomas F. Moran, Inc.



TFM

Civil Engineers
Structural Engineers
Traffic Engineers
Land Surveyors
Landscape Architects
Scientists

48 Constitution Drive
Bedford, NH 03110
Phone (603) 472-4488
Fax (603) 472-9747
www.tfmoran.com

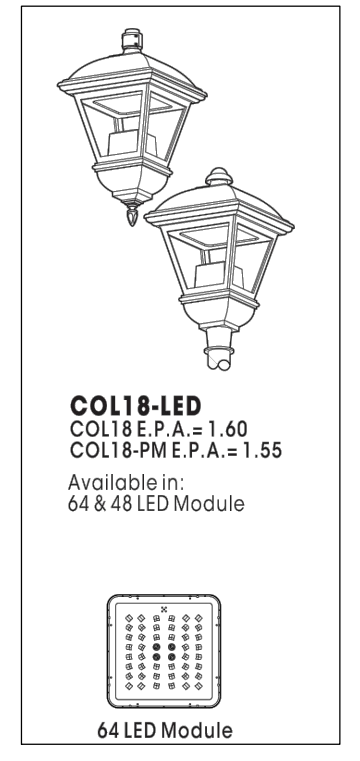
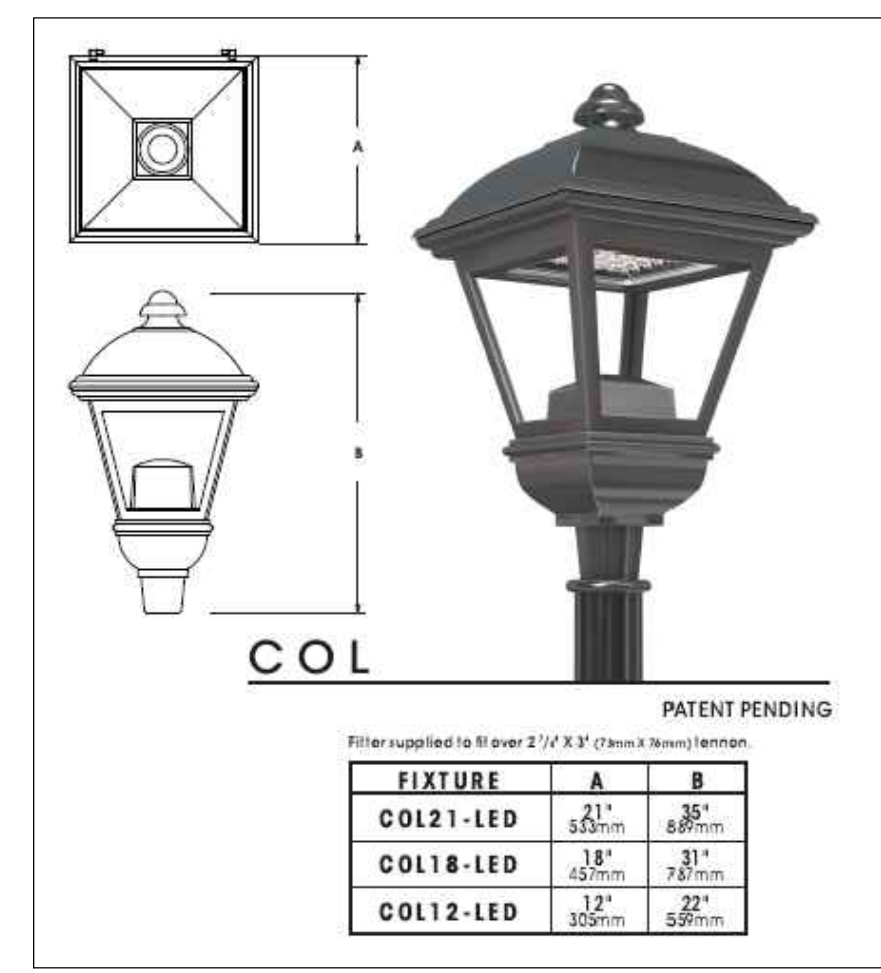
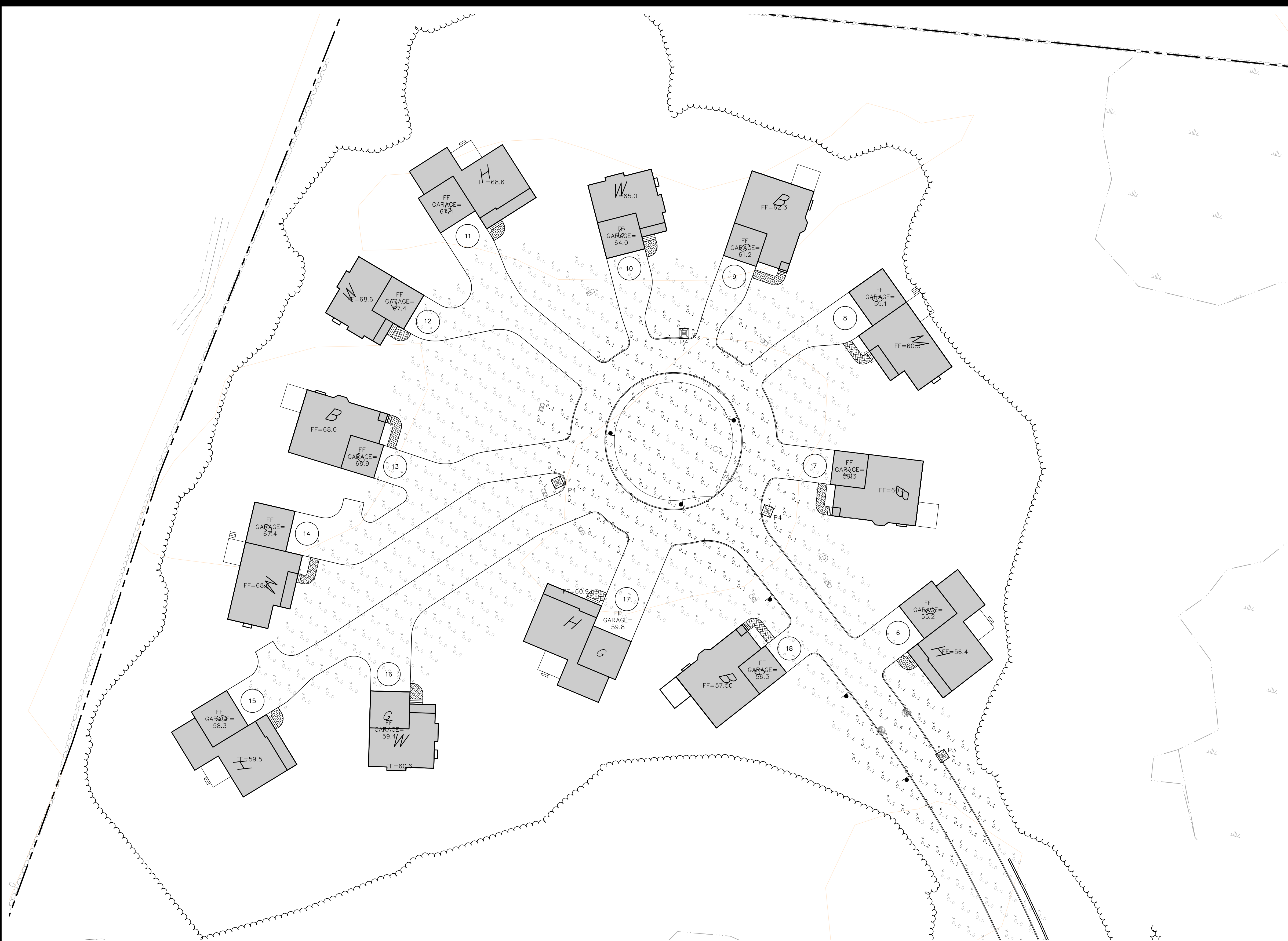

47361.00 DR RCK FB
CK JJM CADFILE LIGHTING C-20B

May 28, 2020 - 12:00pm
F:\MISC Projects\47361 - Portsmouth\47361-100 - Green & Co - Banfield Road\Design\Production Drawings\Lighting.dwg



NOTES
1. PROPOSED ROADWAY LIGHTING SHALL BE DARK SKY FRIENDLY.

SITE DEVELOPMENT PLANS
TAX MAP 256 LOT 2
LIGHTING PLAN
THE VILLAGE AT BANFIELD WOODS
PORTSMOUTH, NH
OWNED BY
WALTER D HETT TRUST
PREPARED FOR
GREEN & COMPANY REAL ESTATE
1"=60' (11"X17")
SCALE: 1"=30' (22"X34") **SEPTEMBER 25, 2019**

Luminaire Schedule				
Symbol	Qty	Label	Arrangement	Description
	2	P3	SINGLE	COL18-III-48VLED-NW-350-HS-PT/ MOUNTED ON 12' WOOD POLE PROVIDED BY OTHERS
	6	P4	SINGLE	COL18-IV-48VLED-NW-350-HS-PT/ MOUNTED ON 12' WOOD POLE PROVIDED BY OTHERS

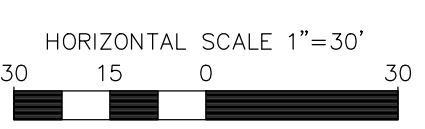

REV	DATE	DESCRIPTION	DR	CK
6	5/5/2020	AoT SUBMITTAL	RCK	JJM
5	4/29/2020	REVISOR PER REGULATORY COMMENTS	RCK	JJM
4	3/20/2020	PROGRESS PRINT	RCK	JJM
3	3/4/2020	UPDATE PLANS PER REGULATORY COMMENTS	RCK	JJM
2	12/27/2019	IN HOUSE REVISIONS	RCK	JJM
1	12/23/19	NO REVISIONS THIS SHEET	RCK	JJM

Copyright 2019 © Thomas F. Moran, Inc.
48 Constitution Drive, Bedford, N.H. 03110
All rights reserved. These plans and materials may not be copied, duplicated, replicated or otherwise reproduced in any form whatsoever without the prior written permission of Thomas F. Moran, Inc.
This plan is not effective unless signed by a duly authorized officer of Thomas F. Moran, Inc.



TFM Civil Engineers
Structural Engineers
Traffic Engineers
Land Surveyors
Landscape Architects
Scientists

48 Constitution Drive
Bedford, NH 03110
Phone (603) 472-4488
Fax (603) 472-9747
www.tfmoran.com

FILE 47361.00 DR RCK FB
CK JUM CADFILE LIGHTING C-20C

May 28, 2020 - 12:01pm
 F:\MISC Projects\47361 - Portsmouth\47361-00 - Green & Co - Banfield Road\Design\Production Drawings\Plan and Profile.dwg

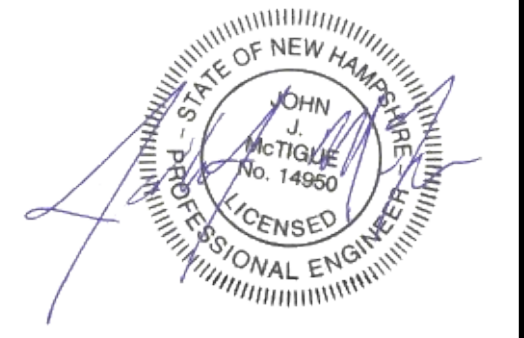
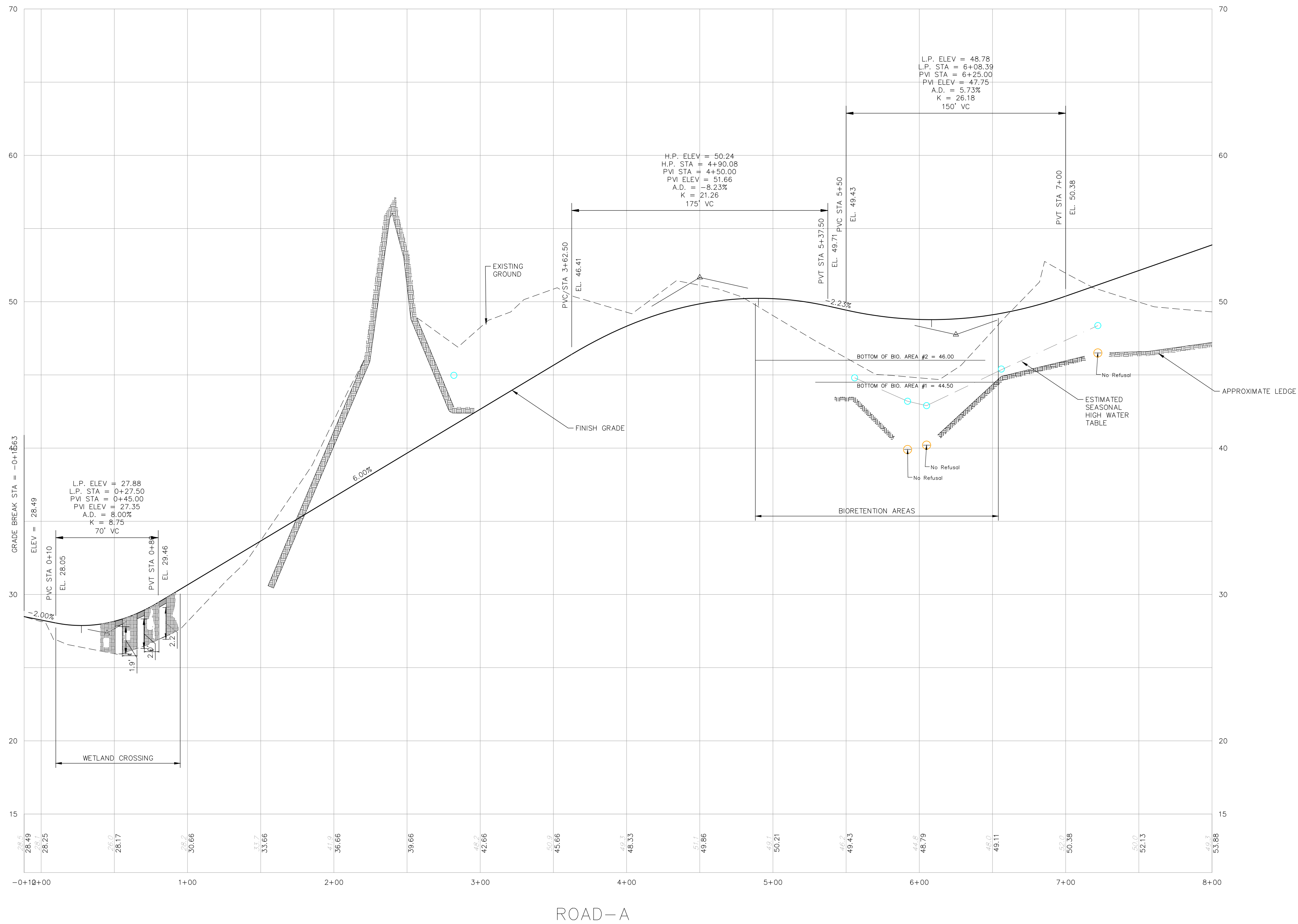

SITE DEVELOPMENT PLANS
 TAX MAP 256 LOT 2
ROAD-A PROFILE
THE VILLAGE AT BANFIELD WOODS
PORTSMOUTH, NH
 OWNED BY
WALTER D HETT TRUST
 PREPARED FOR
GREEN & COMPANY REAL ESTATE
1"=80' (11"X17")
SCALE: 1"=40' (22"X34") **SEPTEMBER 25, 2019**

Copyright 2019 © Thomas F. Moran, Inc.
 48 Constitution Drive, Bedford, N.H. 03110
 All rights reserved. These plans and materials may not be copied, duplicated, replicated or otherwise reproduced in any form whatsoever without the prior written permission of Thomas F. Moran, Inc.
 This plan is not effective unless signed by a duly authorized officer of Thomas F. Moran, Inc.

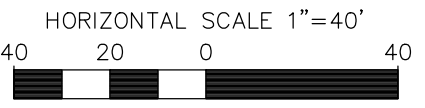

REV	DATE	DESCRIPTION	DR	CK
6	5/5/2020	AoT SUBMITTAL	RCK	JJM
5	4/29/2020	REVISOR PER REGULATORY COMMENTS	RCK	JJM
4	3/20/2020	PROGRESS PRINT	RCK	JJM
3	3/4/2020	UPDATE PLANS PER REGULATORY COMMENTS	RCK	JJM
2	12/27/2019	IN HOUSE REVISIONS	RCK	JJM
1	12/23/19	REVISED PER REGULATORY COMMENTS	RCK	JJM

TFM Civil Engineers
 Structural Engineers
 Traffic Engineers
 Land Surveyors
 Landscape Architects
 Scientists

48 Constitution Drive
 Bedford, NH 03110
 Phone (603) 472-4488
 Fax (603) 472-9747
 www.tfmoran.com

47361.00 DR RCK FB
 CK JIM CADFILE PLAN AND PROFILE

C-21

May 28, 2020 - 12:01pm
F:\MSC Projects\47361 - Portsmouth\47361-00 - Green & Co - Banfield Road\Design\Production Drawings\Plan and Profile.dwg

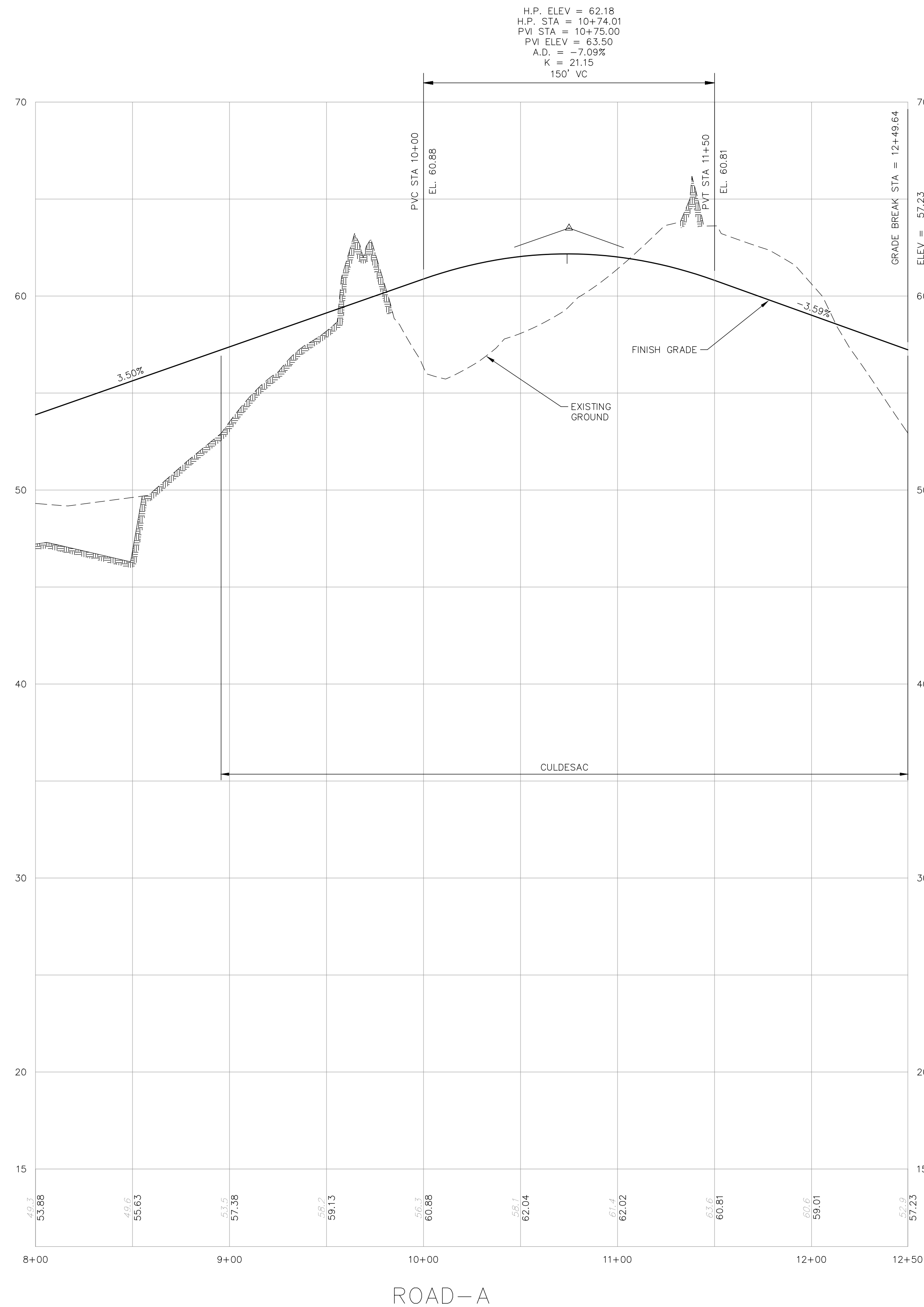

H.P. ELEV = 62.18
H.P. STA = 10+74.01
PVI STA = 10+75.00
PVI ELEV = 63.50
A.D. = -7.09%
K = 21.15
150' VC

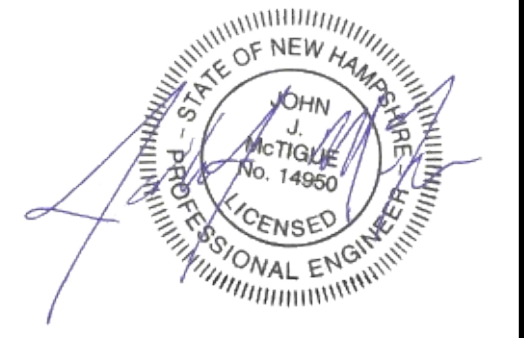

SITE DEVELOPMENT PLANS
TAX MAP 256 LOT 2
ROAD-A PROFILE
THE VILLAGE AT BANFIELD WOODS
PORTSMOUTH, NH
OWNED BY
WALTER D HETT TRUST
PREPARED FOR
GREEN & COMPANY REAL ESTATE
1"=80 (11"X17")
SCALE: 1"=40' (22"X34") **SEPTEMBER 25, 2019**

Copyright 2019 © Thomas F. Moran, Inc.
48 Constitution Drive, Bedford, N.H. 03110
All rights reserved. These plans and materials may not be copied, duplicated, replicated or otherwise reproduced in any form whatsoever without the prior written permission of Thomas F. Moran, Inc.
This plan is not effective unless signed by a duly authorized officer of Thomas F. Moran, Inc.

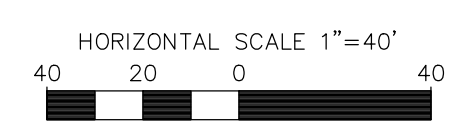
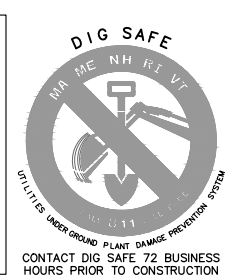

REV	DATE	DESCRIPTION	DR	CK
6	5/5/2020	AoT SUBMITTAL	RCK	JJM
5	4/29/2020	REVISER PER REGULATORY COMMENTS	RCK	JJM
4	3/20/2020	PROGRESS PRINT	RCK	JJM
3	3/4/2020	UPDATE PLANS PER REGULATORY COMMENTS	RCK	JJM
2	12/27/2019	IN HOUSE REVISIONS	RCK	JJM
1	12/23/19	REVISIONS PER REGULATORY COMMENTS	RCK	JJM

TFM	Civil Engineers	48 Constitution Drive
	Structural Engineers	Bedford, NH 03110
	Traffic Engineers	Phone (603) 472-4488
	Land Surveyors	Fax (603) 472-9747
	Landscape Architects	www.tfmoran.com
	Scientists	

47361.00	DR RCK FB	-	C-22
	CK JJM CADFILE	PLAN AND PROFILE	

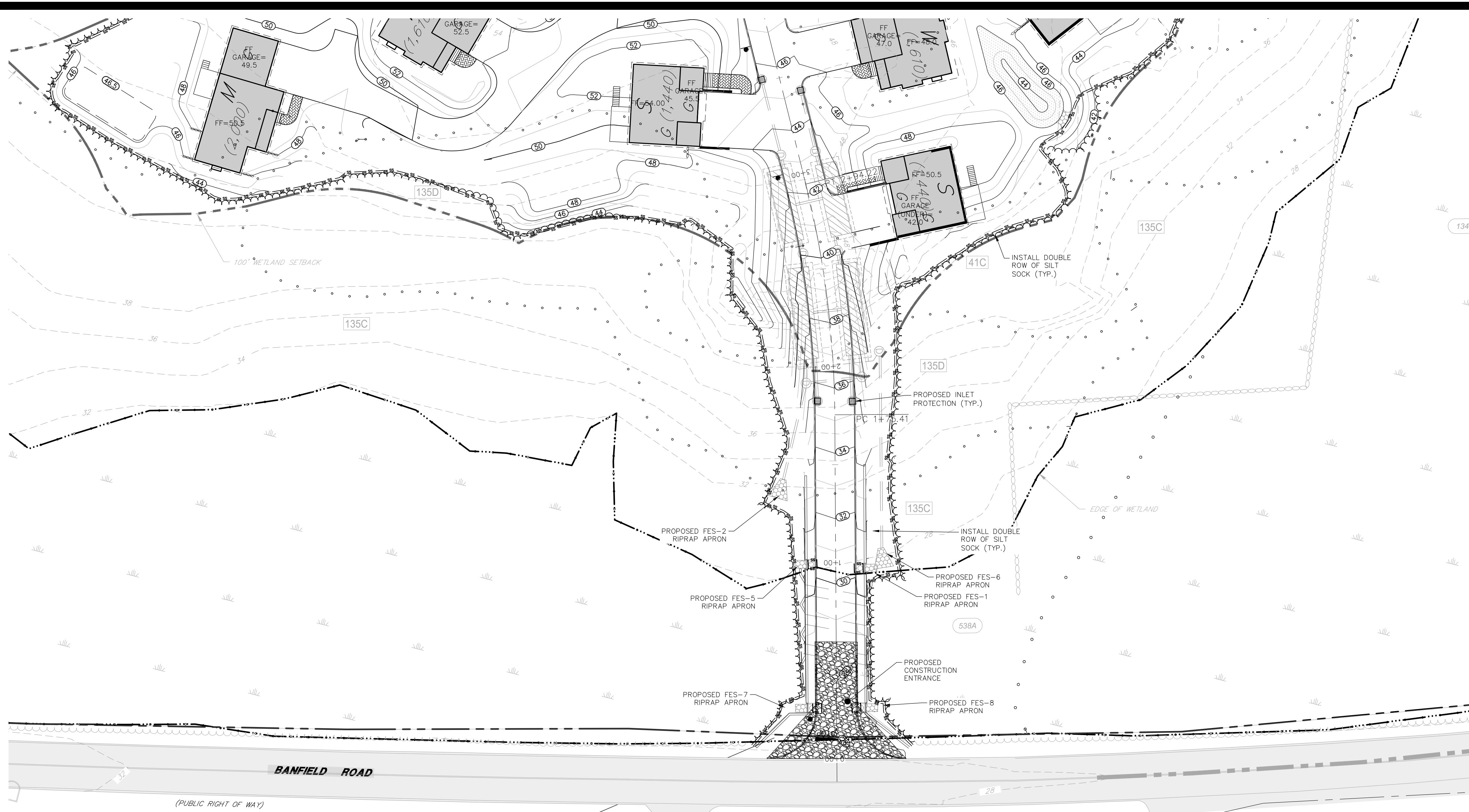

NOTES

- SEE GENERAL EROSION CONTROL NOTES ON THE EROSION CONTROL DETAIL SHEET AND THE APPROVED SWPPP.
- INSTALL SILT BARRIER ALONG THE PERIMETER OF THE AREA TO BE DISTURBED AS FIRST ORDER OF WORK.
- PROVIDE INLET PROTECTION BARRIERS AROUND ALL EXISTING AND PROPOSED STORM DRAINAGE INLETS WITHIN THE WORK LIMITS AND MAINTAIN FOR THE DURATION OF THE PROJECT UNTIL PAVEMENT HAS BEEN INSTALLED. INLET PROTECTION BARRIERS SHALL BE IN PLACE AT ALL CATCH BASINS PRIOR TO THE DISTURBANCE OF SOIL.
- DUST CONTROL SHALL BE MAINTAINED THROUGHOUT THE CONSTRUCTION PERIOD. IT SHALL BE ACCOMPLISHED BY THE UNIFORM APPLICATION OF CALCIUM CHLORIDE AT THE RATE OF 1-1/2 POUNDS PER SQUARE YARD BY MEANS OF A LIME SPREADER OR OTHER APPROVED METHOD. WATER MAY ALSO BE USED FOR DUST CONTROL, AND APPLIED BY SPRINKLING WITH WATER TRUCK DISTRIBUTORS, AS REQUIRED.
- THE SITE WILL REQUIRE A USEPA NPDES PERMIT FOR STORMWATER DISCHARGE FOR THE SITE CONSTRUCTION SINCE THE DISTURBANCE EXCEEDS ONE ACRE. THE CONSTRUCTION SITE OPERATOR SHALL DEVELOP AND IMPLEMENT A CONSTRUCTION STORM WATER POLLUTION PREVENTION PLAN (SWPPP) IN ACCORDANCE WITH EPA REGULATIONS AND THE CONSTRUCTION GENERAL PERMIT WHICH SHALL REMAIN ON SITE AND MADE ACCESSIBLE TO THE PUBLIC. THE SITE CONTRACTOR SHALL COORDINATE WITH THE OWNER TO SUBMIT AN NOI AT LEAST 14 DAYS IN ADVANCE OF ANY EARTHWORK ACTIVITIES AT THE SITE. A COMPLETED NOTICE OF TERMINATION (NOT) SHALL BE SUBMITTED TO NPDES PERMITTING AUTHORITY WITHIN 30 DAYS AFTER EITHER OF THE FOLLOWING CONDITIONS HAVE BEEN MET: FINAL STABILIZATION HAS BEEN ACHIEVED ON ALL PORTIONS OF THE SITE FOR WHICH THE PERMITTEE IS RESPONSIBLE FOR, OR ANOTHER OPERATOR/PERMITTEE HAS ASSUMED CONTROL OVER ALL AREAS OF THE SITE THAT HAVE NOT BEEN FINALLY STABILIZED.
- SILT PROTECTION MEASURES SHALL BE INSTALLED IN ACCORDANCE WITH THE DETAILS CONTAINED IN THIS PLAN SET.
- CONSTRUCT JUTE MATTING ON ALL SLOPES STEEPER THAN 3:1, DISTURBED AREAS SLOPING TOWARDS WETLANDS AND ALL LOCATIONS SHOWN ON PLAN.
- INSPECT EROSION CONTROL MEASURES WEEKLY AND AFTER EACH RAIN STORM OF 0.10" OR GREATER. REPAIR/MODIFY SILT BARRIER AS NECESSARY TO MAXIMIZE FILTER EFFICIENCY. REMOVE SEDIMENT WHEN SEDIMENT IS 1/3 THE STRUCTURE HEIGHT.
- PROVIDE SILT BARRIERS AT THE BASE OF CUT AND FILL SLOPES UNTIL COMPLETION OF THE PROJECT OR UNTIL VEGETATION BECOMES ESTABLISHED ON SLOPES. EROSION PROTECTION BELOW FILL SLOPES SHALL BE PLACED IMMEDIATELY AFTER CLEARING, PRIOR TO EMBANKMENT CONSTRUCTION.
- ALL DISTURBED AREAS SHALL BE REVEGETATED AS QUICKLY AS POSSIBLE. ALL CUT AND FILL SLOPES SHALL BE SEEDED WITHIN 72 HOURS AFTER GRADING.
- ALL WORK AREAS TO BE STABILIZED AT THE END OF EACH WORK DAY AND PRIOR TO ANY PREDICTED SIGNIFICANT RAIN EVENT.
- AN AREA SHALL BE CONSIDERED STABLE IF ONE OF THE FOLLOWING HAS OCCURRED:
 - BASE COURSE GRAVELS ARE INSTALLED IN AREAS TO BE PAVED
 - A MINIMUM OF 85% VEGETATED GROWTH HAS BEEN ESTABLISHED
 - A MINIMUM OF 3" OF NON-EROSIVE MATERIAL SUCH AS STONE OR RIP RAP HAS BEEN INSTALLED
- ALL CATCH BASINS, MANHOLES, AND DRAIN LINES SHALL BE THOROUGHLY CLEANED OF ALL SEDIMENT AND DEBRIS AFTER ALL AREAS HAVE BEEN STABILIZED.
- CONTRACTOR IS RESPONSIBLE FOR MAINTAINING SLOPE STABILITY DURING CONSTRUCTION.
- THE EROSION CONTROL PRACTICES SHOWN ON THESE PLANS ARE ILLUSTRATIVE ONLY AND SHALL BE SUPPLEMENTED BY THE SITE CONTRACTOR AS NEEDED.
- EROSION CONTROL BERM MAY BE USED IN PLACE OF ONE LAYER OF SILT SOCK.
- TURBIDITY CURTAIN TO BE USED IN PLACE OF DOUBLE LAYER OF SILT SOCK WHEN STANDING WATER IS ENCOUNTERED.

BANFIELD ROAD

(PUBLIC RIGHT OF WAY)

ES 226/17

ES 226/16

261

ES 226/15

ES 226/14

SOIL LEGEND	
SITE SPECIFIC SOILS	135B
NRCS SOILS	538A

SOIL LEGEND PER SITE SPECIFIC SOIL SURVEY (SSS)		
SSS SYMBOL	SSS MAP NAME	HYDROLOGIC SOIL GROUP
41	CHATFIELD-HOLLIS-ROCK OUTCROP COMPLEX	B
135	CHATFIELD VARIANT-NEWFIELDS COMPLEX	C
538	SQUAMSCOTT FINE SANDY LOAM	C
656	RIDGEBURY FINE SANDY LOAM	C
SLOPE PHASE:		
0-8%	B	
8-15%	C	
15-25%	D	
25%+	E	

SOIL LEGEND PER USDA NRCS WEB SOIL SURVEY			
NRCS SYMBOL	NRCS DESCRIPTION		HYDROLOGIC SOIL GROUP
38B	ELDRIDGE FINE SANDY LOAM, - 8% SLOPES	3%	C/D
140B	CHATFIELD-HOLLIS-CANTON COMPLEX, 0% - 8%		B
140C	CHATFIELD-HOLLIS-CANTON COMPLEX, 8% - 15%		B
299	UDORTHENTS		-
538A	SQUAMSCOTT FINE SANDY LOAM, 0% - 5%		C/D

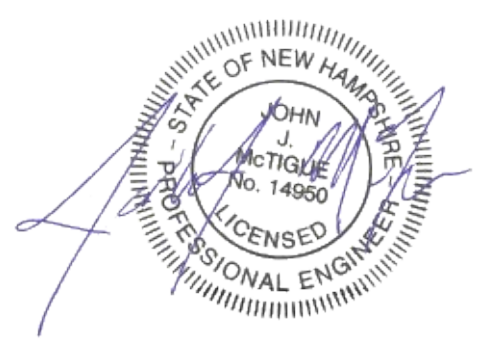
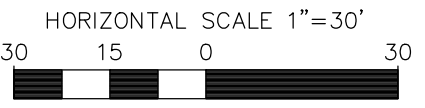

SITE DEVELOPMENT PLANS

TAX MAP 256 LOT 2
EROSION CONTROL PLAN
THE VILLAGE AT BANFIELD WOODS
PORTSMOUTH, NH

OWNED BY
WALTER D HETT TRUST

PREPARED FOR
GREEN & COMPANY REAL ESTATE

1"=60' (11"X17")
SCALE: 1"=30' (22"X34") **SEPTEMBER 25, 2019**



Civil Engineers
 Structural Engineers
 Traffic Engineers
 Land Surveyors
 Landscape Architects
 Scientists

48 Constitution Drive
 Bedford, NH 03110
 Phone (603) 472-4488
 Fax (603) 472-9747
 www.tfmoran.com

REV	DATE	DESCRIPTION	DR	CK
6	5/5/2020	AoT SUBMITTAL	RCK	JJM
5	4/29/2020	REVISOR PER REGULATORY COMMENTS	RCK	JJM
4	3/20/2020	PROGRESS PRINT	RCK	JJM
3	3/4/2020	UPDATE PLANS PER REGULATORY COMMENTS	RCK	JJM
2	12/27/2019	IN HOUSE REVISIONS	RCK	JJM
1	12/23/19	NO REVISIONS THIS SHEET	RCK	JJM

FILE	47361.00	DR	RCK	FB			
		CK	JJM	CADFILE	EROSION		

May 28, 2020 - 12:02pm F:\MISC Projects\47361 - Portsmouth\47361-00 - Green & Co - Banfield Road\Design\Production Drawings\Erosion.dwg

Copyright 2019 © Thomas F. Moran, Inc.
 48 Constitution Drive, Bedford, N.H. 03110
 All rights reserved. These plans and materials may not be copied, duplicated, replicated or otherwise reproduced in any form whatsoever without the prior written permission of Thomas F. Moran, Inc.
 This plan is not effective unless signed by a duly authorized officer of Thomas F. Moran, Inc.



May 28, 2020 - 12:02pm F:\MISC Projects\47361 - Portsmouth\47361-00 - Green & Co - Banfield Road\Design\Production Drawings\Erosion.dwg

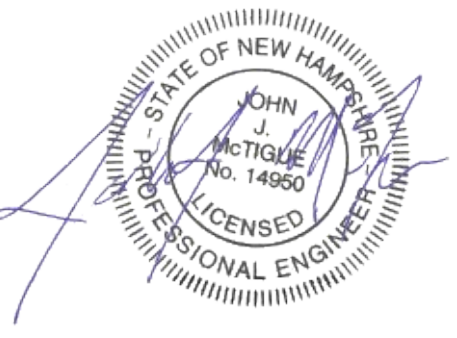
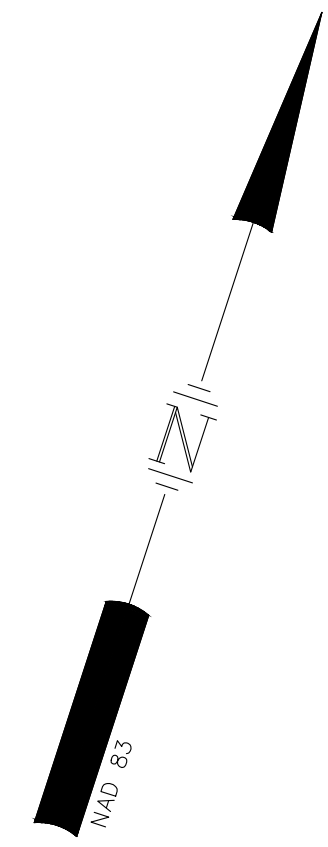
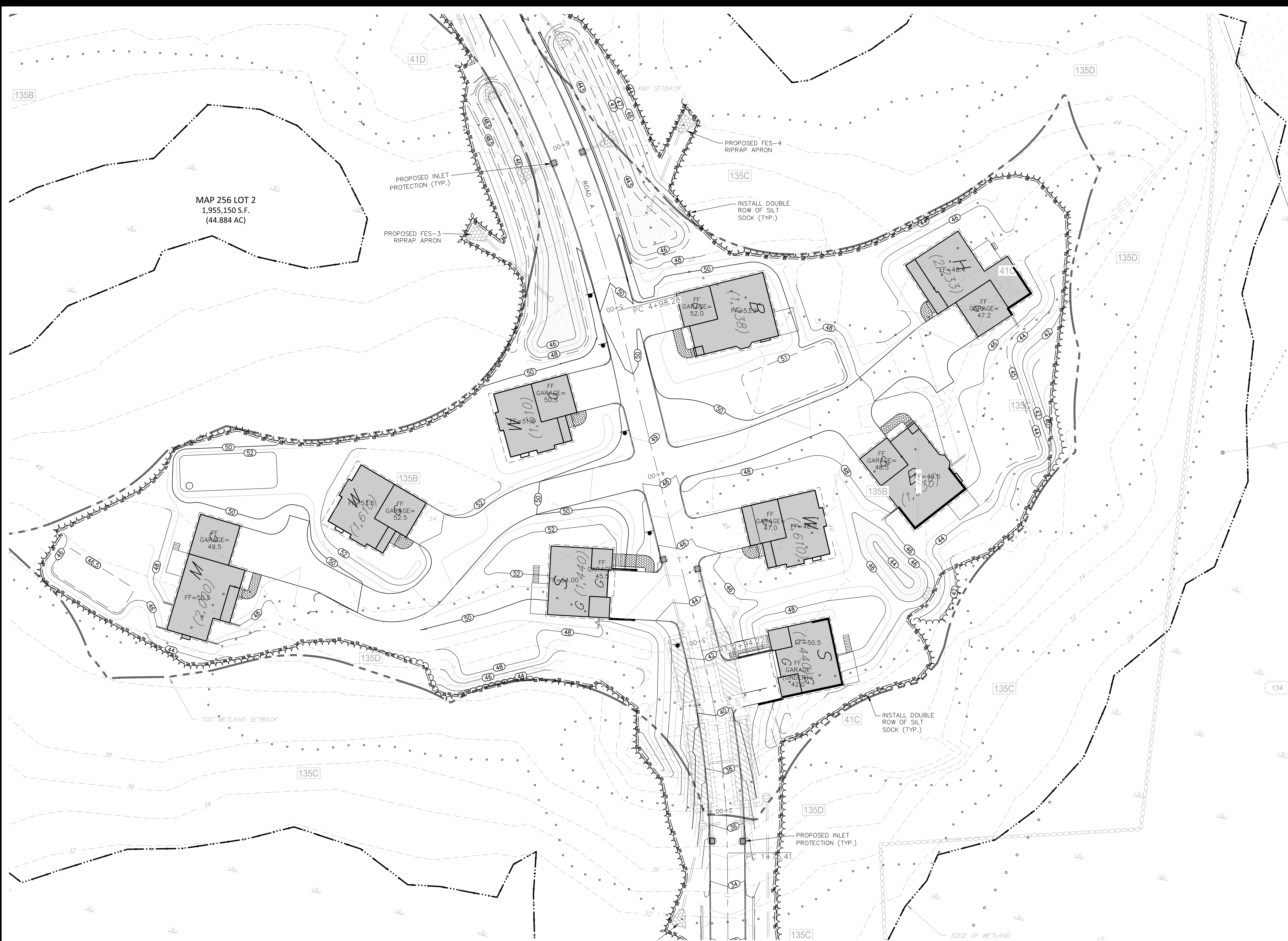

SITE DEVELOPMENT PLANS
 TAX MAP 256 LOT 2
EROSION CONTROL PLAN
THE VILLAGE AT BANFIELD WOODS
PORTSMOUTH, NH
 OWNED BY
WALTER D HETT TRUST
 PREPARED FOR
GREEN & COMPANY REAL ESTATE
1"=60' (11"X17")
SCALE: 1"=30' (22"X34") **SEPTEMBER 25, 2019**

Copyright 2019 © Thomas F. Moran, Inc.
 48 Constitution Drive, Bedford, N.H. 03110
 All rights reserved. These plans and materials may not be copied, duplicated, replicated or otherwise reproduced in any form whatsoever without the prior written permission of Thomas F. Moran, Inc.
 This plan is not effective unless signed by a duly authorized officer of Thomas F. Moran, Inc.



HORIZONTAL SCALE 1"=30'
 30 15 0 30

REV	DATE	DESCRIPTION	DR	CK
6	5/5/2020	AoT SUBMITTAL	RCK	JJM
5	4/29/2020	REVISOR PER REGULATORY COMMENTS	RCK	JJM
4	3/20/2020	PROGRESS PRINT	RCK	JJM
3	3/4/2020	UPDATE PLANS PER REGULATORY COMMENTS	RCK	JJM
2	12/27/2019	IN HOUSE REVISIONS	RCK	JJM
1	12/23/19	NO REVISIONS THIS SHEET	RCK	JJM

TFM	Civil Engineers	48 Constitution Drive
	Structural Engineers	Bedford, NH 03110
	Traffic Engineers	Phone (603) 472-4488
	Land Surveyors	Fax (603) 472-9747
	Landscape Architects	www.tfmoran.com
	Scientists	

47361.00 DR RCK FB
 CK JJM CADFILE EROSION C-24

May 28, 2020 - 12:02pm
 F:\MISC Projects\47361 - Portsmouth\47361-00 - Green & Co - Banfield Road\Design\Production Drawings\Erosion.dwg

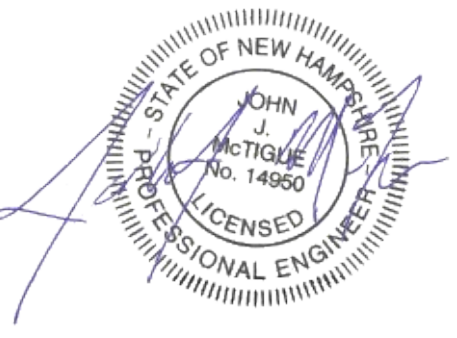
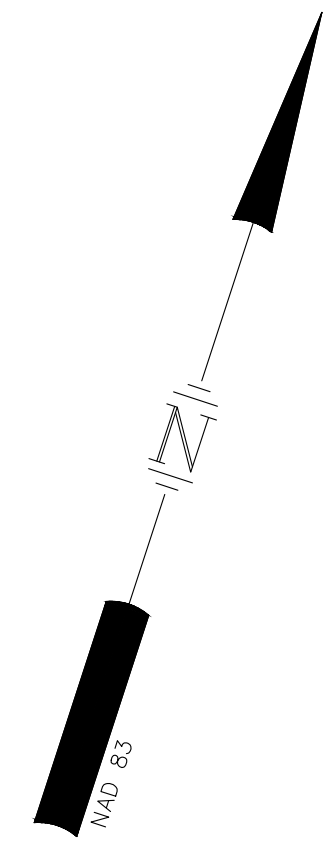

SITE DEVELOPMENT PLANS
 TAX MAP 256 LOT 2
EROSION CONTROL PLAN
THE VILLAGE AT BANFIELD WOODS
PORTSMOUTH, NH
 OWNED BY
WALTER D HETT TRUST
 PREPARED FOR
GREEN & COMPANY REAL ESTATE
1"=60' (11"X17")
SCALE: 1"=30' (22"X34") **SEPTEMBER 25, 2019**

Copyright 2019 © Thomas F. Moran, Inc.
 48 Constitution Drive, Bedford, N.H. 03110
 All rights reserved. These plans and materials may not be copied, duplicated, replicated or otherwise reproduced in any form whatsoever without the prior written permission of Thomas F. Moran, Inc.
 This plan is not effective unless signed by a duly authorized officer of Thomas F. Moran, Inc.



HORIZONTAL SCALE 1"=30'
 30 15 0 30

REV	DATE	DESCRIPTION	DR	CK
6	5/5/2020	AoT SUBMITTAL	RCK	JJM
5	4/29/2020	REVISOR PER REGULATORY COMMENTS	RCK	JJM
4	3/20/2020	PROGRESS PRINT	RCK	JJM
3	3/4/2020	UPDATE PLANS PER REGULATORY COMMENTS	RCK	JJM
2	12/27/2019	IN HOUSE REVISIONS	RCK	JJM
1	12/23/19	NO REVISIONS THIS SHEET	RCK	JJM

	Civil Engineers Structural Engineers Traffic Engineers Land Surveyors Landscape Architects Scientists			48 Constitution Drive Bedford, NH 03110 Phone (603) 472-4488 Fax (603) 472-9747 www.tfmoran.com		
	47361.00	DR RCK CK JJM	FB CADFILE	- EROSION	C-25	

SOIL CHARACTERISTICS

THE SOIL IN THE VICINITY OF THE SITE CONSISTS OF CHATFIELD-HOLLIS-CANTON AND SQUAMSCOTT FINE SANDY LOAM, THE MAJORITY OF THE SOIL IS HSG TYPE B.

DISTURBED AREA

THE TOTAL AREA TO BE DISTURBED IS APPROXIMATELY 330,672 SQUARE FEET (7.60 ACRES). CONSTRUCTION SHALL BE PHASED TO LIMIT DISTURBED AREAS TO LESS THAN 5 ACRES.

CRITICAL NOTE: THIS DRAWING IS PROVIDED FOR GENERAL GUIDANCE. ALL SPECIAL EROSION CONTROL MEASURES MUST BE EXECUTED IN ACCORDANCE WITH CURRENT STATE AND LOCAL REGULATIONS, APPROVED SWPPP AND PERMIT REQUIREMENTS.

SEQUENCE OF MAJOR ACTIVITIES

1. INSTALL STABILIZED CONSTRUCTION ENTRANCE AND TEMPORARY EROSION CONTROL MEASURES PER APPROVED SWPPP IF REQUIRED.
2. CLEAR TREES DESIGNATED FOR REMOVAL.
3. COMPLETE MAJOR GRADING OF SITE.
4. CONSTRUCT STORMWATER SYSTEM, AND SITE UTILITIES.
5. CONSTRUCT ROAD TO SUBGRADE ELEVATION.
6. WHEN ALL CONSTRUCTION ACTIVITY IS COMPLETE AND SITE IS STABILIZED, REMOVE ALL INLET PROTECTION, SILT BARRIERS AND SEDIMENT THAT HAS BEEN TRAPPED BY THESE DEVICES.
7. CONSULT APPROVED SWPPP FOR CONDITIONS RELATED TO NOTICE OF TERMINATION, IF REQUIRED.

EROSION AND SEDIMENT CONTROLS AND STABILIZATION PRACTICES

STABILIZATION SHALL BE INITIATED ON ALL LOAM STOCKPILES AND DISTURBED AREAS WHERE CONSTRUCTION ACTIVITY WILL NOT OCCUR FOR MORE THAN TWENTY ONE (21) CALENDAR DAYS BY THE FOURTEENTH (14TH) DAY AFTER CONSTRUCTION ACTIVITY HAS PERMANENTLY OR TEMPORARILY CEASED IN THAT AREA. ALL DISTURBED AREAS SHALL BE STABILIZED WITHIN 45 DAYS OF INITIAL DISTURBANCE. AN AREA SHALL BE CONSIDERED STABLE IF ONE OF THE FOLLOWING HAS OCCURRED:

1. BASE COURSE GRAVELS HAVE BEEN INSTALLED IN AREAS TO BE PAVED;
2. A MINIMUM OF 85% VEGETATED GROWTH HAS BEEN ESTABLISHED;
3. A MINIMUM OF 3" OF NON-EROSIVE MATERIAL SUCH AS STONE OR RIPRAP HAS BEEN INSTALLED; OR
4. EROSION CONTROL BLANKETS HAVE BEEN PROPERLY INSTALLED.

DURING CONSTRUCTION, RUNOFF WILL BE DIVERTED AROUND THE SITE WITH EARTH DIKES, PIPING OR STABILIZED CHANNELS WHERE POSSIBLE. SHEET RUNOFF FROM THE SITE WILL BE FILTERED THROUGH SILT BARRIERS. ALL STORM DRAIN INLETS SHALL BE PROVIDED WITH BARRIER FILTERS. STONE RIPRAP SHALL BE PROVIDED AT THE OUTLETS OF DRAINAGE PIPES WHERE EROSION VELOCITIES ARE ENCOUNTERED.

OFF SITE VEHICLE TRACKING

STABILIZED CONSTRUCTION ENTRANCES SHALL BE INSTALLED.

INSTALLATION, MAINTENANCE AND INSPECTION OF EROSION AND SEDIMENT CONTROLS

A. GENERAL

THESE ARE THE GENERAL INSPECTION AND MAINTENANCE PRACTICES THAT WILL BE USED TO IMPLEMENT THE PLAN.

1. STABILIZATION OF ALL SWALES, DITCHES AND PONDS IS REQUIRED PRIOR TO DIRECTING FLOW TO THEM.
2. THE SMALLEST PRACTICAL PORTION OF THE SITE WILL BE DENUDED AT ONE TIME. (5 AC MAX)
3. ALL CONTROL MEASURES WILL BE INSPECTED AT LEAST ONCE EACH WEEK AND FOLLOWING ANY STORM EVENT OF 0.50" OR GREATER.
4. ALL MEASURES WILL BE MAINTAINED IN GOOD WORKING ORDER. IF A REPAIR IS NECESSARY, IT WILL BE INITIATED WITHIN 24 HOURS OF REPORT.
5. BUILT UP SEDIMENT WILL BE REMOVED FROM SILT BARRIER WHEN IT HAS REACHED ONE THIRD THE HEIGHT OF THE BARRIER.
6. ALL DIVERSION DIKES WILL BE INSPECTED AND ANY BREACHES PROMPTLY REPAIRED.
7. TEMPORARY SEEDING AND PLANTING WILL BE INSPECTED FOR BARE SPOTS, WASHOUTS, AND UNHEALTHY GROWTH.
8. A MAINTENANCE INSPECTION REPORT WILL BE MADE AFTER EACH INSPECTION.
9. THE CONTRACTOR'S SITE SUPERINTENDENT WILL BE RESPONSIBLE FOR INSPECTIONS, MAINTENANCE AND REPAIR ACTIVITIES, AND FILLING OUT THE INSPECTION AND MAINTENANCE REPORT.

B. FILTERS / BARRIERS

1. SILT SOCKS
 - A. KNOTTED MESH NETTING MATERIAL SHALL BE DELIVERED TO SITE IN A 5 MIL CONTINUOUS, TUBULAR, HDPE 3/8" MATERIAL, FILLED WITH COMPOST CONFORMING TO THE FOLLOWING REQUIREMENTS:

PHYSICAL PROPERTY	TEST	REQUIREMENTS
PH	TMECC 04.11-A	5.0 TO 8.0
PARTICLE SIZE	TMECC 02.02-B	2" SIEVE AND MIN. 60% GREATER THAN THE 8" SIEVE
MOISTURE CONTENT		STND TESTING < 60%

 MATERIAL SHALL BE RELATIVELY FREE OF INERT OR FOREIGN MAN-MADE MATERIALS. MATERIAL SHALL BE WEED FREE AND DERIVED FROM A WELL-DECOMPOSED SOURCE OF ORGANIC MATTER, FREE FROM ANY REFUSE, CONTAMINANTS OR OTHER MATERIALS TOXIC TO PLANT GROWTH.
 - B. SEDIMENT COLLECTED AT THE BASE OF THE SILT SOCK SHALL BE REMOVED ONCE IT HAS REACHED 1/3 OF THE EXPOSED HEIGHT OF THE SILT SOCK.
 - C. SILT BARRIER SHALL BE REMOVED WHEN THEY HAVE SERVED THEIR USEFUL PURPOSE, BUT NOT BEFORE THE UPSLOPE AREAS HAS BEEN PERMANENTLY STABILIZED.
2. SEQUENCE OF INSTALLATION

SEDIMENT BARRIERS SHALL BE INSTALLED PRIOR TO ANY SOIL DISTURBANCE OF THE CONTRIBUTING DRAINAGE AREA ABOVE THEM.
3. MAINTENANCE
 - A. SILT BARRIERS SHALL BE INSPECTED WEEKLY AND IMMEDIATELY AFTER EACH RAINFALL AND AT LEAST DAILY DURING PROLONGED RAINFALL. THEY SHALL BE REPAIRED IF THERE ARE ANY SIGNS OF EROSION OR SEDIMENTATION BELOW THEM. ANY REQUIRED REPAIRS SHALL BE MADE IMMEDIATELY. IF THERE ARE SIGNS OF UNDERCUTTING AT THE CENTER OR THE EDGES, OR IMPOUNDING OF LARGE VOLUMES OF WATER BEHIND THEM, SEDIMENT BARRIERS SHALL BE REPLACED WITH A TEMPORARY CHECK DAM.
 - B. SHOULD THE FABRIC DECOMPOSE OR BECOME INEFFECTIVE PRIOR TO THE END OF THE EXPECTED USABLE LIFE AND THE BARRIER STILL IS NECESSARY, THE FABRIC SHALL BE REPLACED PROMPTLY.
 - C. SEDIMENT DEPOSITS SHOULD BE REMOVED AFTER EACH STORM EVENT. THEY MUST BE REMOVED WHEN DEPOSITS REACH APPROXIMATELY ONE THIRD (1/3) THE HEIGHT OF THE BARRIER.
 - D. ANY SEDIMENT DEPOSITS REMAINING IN PLACE AFTER THE SILT BARRIER IS NO LONGER REQUIRED SHALL BE DRESSED TO CONFIRM WITH THE EXISTING GRADE, PREPARED AND SEEDED.

C. MULCHING

1. TIMING

IN ORDER FOR MULCH TO BE EFFECTIVE, IT MUST BE IN PLACE PRIOR TO MAJOR STORM EVENTS. THERE ARE TWO (2) TYPES OF STANDARDS WHICH SHALL BE USED TO ASSURE THIS:

 - A. APPLY MULCH PRIOR TO ANY STORM EVENT.

THIS IS APPLICABLE WHEN WORKING WITHIN 100' OF WETLANDS. IT WILL BE NECESSARY TO CLOSELY MONITOR WEATHER PREDICTIONS, USUALLY BY CONTACTING THE NATIONAL WEATHER SERVICE, TO HAVE ADEQUATE WARNING OF SIGNIFICANT STORMS.

- B. REQUIRED MULCHING WITHIN A SPECIFIED TIME PERIOD.

THE TIME PERIOD CAN RANGE FROM 14 TO 21 DAYS OF INACTIVITY ON AN AREA, WHERE THE LENGTH OF TIME VARIES WITH SITE CONDITIONS. PROFESSIONAL JUDGMENT SHALL BE USED TO EVALUATE THE INTERACTION OF SITE CONDITIONS (SOIL ERODIBILITY, SEASON OF YEAR, EXTENT OF DISTURBANCE, PROXIMITY TO SENSITIVE RESOURCES, ETC.) AND THE POTENTIAL IMPACT OF EROSION ON ADJACENT AREAS TO CHOOSE AN APPROPRIATE TIME RESTRICTION.

2. GUIDELINES FOR WINTER MULCH APPLICATION.

WHEN MULCH IS APPLIED TO PROVIDE PROTECTION OVER WINTER (PAST THE GROWING SEASON) IT SHALL BE AT A RATE OF 6,000 POUNDS OF HAY OR STRAW PER ACRE. A TACKIFIER MAY BE ADDED TO THE MULCH.

3. MAINTENANCE

ALL MULCHES MUST BE INSPECTED PERIODICALLY, IN PARTICULAR AFTER RAINSTORMS, TO CHECK FOR RILL EROSION. IF LESS THAN 90% OF THE SOIL SURFACE IS COVERED BY MULCH, ADDITIONAL MULCH SHALL BE IMMEDIATELY APPLIED.

D. VEGETATIVE PRACTICE

1. AFTER ROUGH GRADING OF THE SUBGRADE HAS BEEN COMPLETED AND APPROVED, THE SUB GRADE SURFACE SHALL BE SCARIFIED TO A DEPTH OF 4". THEN, FURNISH AND INSTALL A LAYER OF LOAM PROVIDING A ROLLED THICKNESS AS SPECIFIED IN THESE PLANS. ANY DEPRESSIONS WHICH MAY OCCUR DURING ROLLING SHALL BE FILLED WITH ADDITIONAL LOAM, REGRADED AND ROLLED UNTIL THE SURFACE IS TRUE TO THE FINISHED LINES AND GRADES. ALL LOAM NECESSARY TO COMPLETE THE WORK UNDER THIS SECTION SHALL BE SUPPLIED BY THE SITE SUBCONTRACTOR.

2. ALL LARGE STIFF CLODS, LUMPS, BRUSH, ROOTS, DEBRIS, GLASS, STUMPS, LITTER AND OTHER FOREIGN MATERIAL, AS WELL AS STONES OVER 1" IN DIAMETER, SHALL BE REMOVED FROM THE LOAM AND DISPOSED OF OFF SITE. THE LOAM SHALL BE RAKED SMOOTH AND EVEN.

3. THE LOAM SHALL BE PREPARED TO RECEIVE SEED BY REMOVING STONES, FOREIGN OBJECTS AND GRADING TO ELIMINATE WATER POCKETS AND IRREGULARITIES PRIOR TO PLACING SEED. FINISH GRADING SHALL RESULT IN STRAIGHT UNIFORM GRADES AND SMOOTH, EVEN SURFACES WITHOUT IRREGULARITIES TO LOW POINTS.

4. SHAPE THE AREAS TO THE LINES AND GRADES REQUIRED. THE SITE SUBCONTRACTOR'S ATTENTION IS DIRECTED TO THE SCHEDULING OF LOAMING AND SEEDING OF GRADED AREAS TO PERMIT SUFFICIENT TIME FOR THE STABILIZATION OF THESE AREAS. IT SHALL BE THE SITE SUBCONTRACTOR'S RESPONSIBILITY TO MAINTAIN THE AREAS DURING THE CONSTRUCTION PERIOD AND REGRADE, LOAM AND RESEED ANY DAMAGED AREAS.

5. ALL AREAS DISTURBED BY CONSTRUCTION WITHIN THE PROPERTY LINES AND NOT COVERED BY STRUCTURES, PAVEMENT, OR MULCH SHALL BE LOAMED AND SEEDED.

6. LIMESTONE SHALL BE THOROUGHLY INCORPORATED INTO THE LOAM LAYER AT A RATE OF 2 TONS PER ACRE IN ORDER TO PROVIDE A PH VALUE OF 5.5 TO 6.5.

7. FERTILIZER SHALL BE SPREAD ON THE TOP LAYER OF LOAM AND WORKED INTO THE SURFACE. FERTILIZER APPLICATION RATE SHALL BE 500 POUNDS PER ACRE OF 10-20-20 FERTILIZER.

8. SOIL CONDITIONERS AND FERTILIZER SHALL BE APPLIED AT THE RECOMMENDED RATES AND SHALL BE THOROUGHLY WORKED INTO THE LOAM. LOAM SHALL BE RAKED UNTIL THE SURFACE IS FINELY PULVERIZED, SMOOTH AND EVEN, AND THEN COMPACTED TO AN EVEN SURFACE CONFORMING TO THE REQUIRED LINES AND GRADES WITH APPROVED ROLLERS WEIGHING BETWEEN 4 1/2 POUNDS AND 5 1/2 POUNDS PER INCH OF WIDTH.

9. SEED SHALL BE SOWN AT THE RATE SHOWN BELOW. SOWING SHALL BE DONE ON A CALM, DRY DAY, PREFERABLY BY MACHINE, BUT IF BY HAND, ONLY BY EXPERIENCED WORKMEN. IMMEDIATELY BEFORE SEEDING, THE SOIL SHALL BE LIGHTLY RAKED. ONE HALF THE SEED SHALL BE SOWN IN ONE DIRECTION AND THE OTHER HALF AT RIGHT ANGLES TO THE ORIGINAL DIRECTION. IT SHALL BE LIGHTLY RAKED INTO THE SOIL TO A DEPTH NOT OVER 1/4" AND ROLLED WITH A HAND ROLLER WEIGHING NOT OVER 100 POUNDS PER LINEAR FOOT OF WIDTH.

10. HAY MULCH SHALL BE APPLIED IMMEDIATELY AFTER SEEDING AT A RATE OF 1.5 TO 2 TONS PER ACRE. MULCH THAT BLOWS OR WASHES AWAY SHALL BE REPLACED IMMEDIATELY AND ANCHORED USING APPROPRIATE TECHNIQUES FROM THE EROSION AND SEDIMENT CONTROL HANDBOOK.

11. THE SURFACE SHALL BE WATERED AND KEPT MOIST WITH A FINE SPRAY AS REQUIRED, WITHOUT WASHING AWAY THE SOIL, UNTIL THE GRASS IS WELL ESTABLISHED. ANY AREAS WHICH ARE NOT SATISFACTORILY COVERED WITH GRASS SHALL BE RESEDED, AND ALL NOXIOUS WEEDS REMOVED.

12. THE SITE SUBCONTRACTOR SHALL PROTECT AND MAINTAIN THE SEEDED AREAS UNTIL ACCEPTED, INCLUDING CUTTING, AS SPECIFIED HEREIN AFTER UNDER MAINTENANCE AND PROTECTION.

13. UNLESS OTHERWISE APPROVED, SEEDING SHALL BE DONE DURING THE APPROXIMATE PERIODS OF EARLY SPRING TO SEPTEMBER 30, WHEN SOIL CONDITIONS AND WEATHER ARE SUITABLE FOR SUCH WORK. IN NO CASE SHALL THE WEED CONTENT EXCEED 1 PERCENT BY WEIGHT. ALL SEED SHALL COMPLY WITH STATE AND FEDERAL SEED LAWS. FOR TEMPORARY PLANTINGS AFTER SEPTEMBER 30, TO EARLY SPRING AND FOR TEMPORARY PROTECTION OF DISTURBED AREAS:
 - A. FOLLOW ABOVE SLOPE, LOAM DEPTH AND GRADING REQUIREMENTS.
 - B. FERTILIZER SHALL BE SPREAD AND WORKED INTO THE SURFACE AT A RATE OF 300 POUNDS PER ACRE.

MULCHING AND SEEDING SHALL BE APPLIED AT THE FOLLOWING RATES:

WINTER RYE (FALL SEEDING)	2.5 LBS/1,000 SF
OATS (SPRING SEEDING)	2.0 LBS/1,000 SF
MULCH	1.5 TONS/ACRE

E. CATCH BASIN INLET PROTECTION

1. INLET BASKET STRUCTURE
 - A. INLET PROTECTION SHALL BE INSTALLED IMMEDIATELY PRIOR TO DISTURBING PAVEMENT AND SHALL REMAIN IN PLACE AND MAINTAINED UNTIL PAVEMENT BINDER COURSE IS COMPLETE.
 - B. MOLD 6X6, 42 LB. WIRE SUPPORT AROUND INLET FRAME AND GRATE AND EXTEND 6" BEYOND SIDES. SECURE FILTER FABRIC TO WIRE SUPPORT.
 - C. THE FILTER FABRIC SHALL BE A GEOTEXTILE FABRIC: POLYESTER, POLYPROPYLENE, STABILIZED NYLON, POLYETHYLENE OR POLYVINYLIDENE CHLORIDE MEETING THE FOLLOWING SPECIFICATIONS:

GRAB STRENGTH: 45 LB. MINIMUM IN ANY PRINCIPAL DIRECTION (ASTM D1682)
MULLEN BURST STRENGTH: MIN. 60PSI (ASTM D774)
 - D. THE FABRIC SHALL HAVE AN OPENING NO GREATER THAN A NUMBER 20 U.S. STANDARD SIEVE AND A MINIMUM PERMEABILITY OF 120 GPM.
 - E. THE INLET PROTECTION SHALL BE INSPECTED WITHIN 24 HOURS AFTER EACH RAINFALL OR DAILY DURING EXTENDED PERIODS OF PRECIPITATION. REPAIRS SHALL BE MADE IMMEDIATELY, AS NECESSARY, TO PREVENT PARTICLES FROM REACHING THE DRAINAGE SYSTEM AND/OR CAUSING SURFACE FLOODING.
 - F. SEDIMENT DEPOSITS SHALL BE REMOVED AFTER EACH STORM EVENT, OR MORE OFTEN IF THE FABRIC BECOMES CLOGGED.

F. WINTER CONSTRUCTION SEQUENCE

1. ALL PROPOSED POST-DEVELOPMENT LANDSCAPED AREAS WHICH DO NOT EXHIBIT A MINIMUM OF 85% VEGETATIVE GROWTH BY OCTOBER 15TH, OR WHICH ARE DISTURBED AFTER OCTOBER 15TH, SHALL BE STABILIZED BY SEEDING AND INSTALLING EROSION CONTROL BLANKETS ON SLOPES GREATER THAN 3:1 AND SEEDING AND PLACING 3 TO 4 TONS OF MULCH PER ACRE, SECURED WITH ANCHORED NETTING, ELSEWHERE. THE PLACEMENT OF EROSION CONTROL BLANKETS OR MULCH AND NETTING SHALL NOT OCCUR OVER ACCUMULATED SNOW OR ON FROZEN GROUND AND SHALL BE COMPLETED IN ADVANCE OF THAW OR SPRING MELT EVENT.
2. ALL DITCHES OR SWALES WHICH DO NOT EXHIBIT A MINIMUM OF 85% VEGETATIVE GROWTH BY OCTOBER 15TH, OR WHICH ARE DISTURBED AFTER OCTOBER 15TH, SHALL BE STABILIZED WITH STONE OR EROSION CONTROL BLANKETS APPROPRIATE FOR THE DESIGN FLOW CONDITIONS.
3. AFTER OCTOBER 15TH, ALL TRAVEL SURFACES SHALL BE PROTECTED WITH A MINIMUM OF 3" OF CRUSHED GRAVEL PER NHDOT ITEM 304.3, OR IF CONSTRUCTION IS TO CONTINUE THROUGH THE WINTER SEASON BE CLEARED OF ANY ACCUMULATED SNOWFALL AFTER EACH STORM EVENT.

TIMING OF CONTROLS/MEASURES

AS INDICATED IN THE SEQUENCE OF MAJOR ACTIVITIES, SILT BARRIERS SHALL BE INSTALLED PRIOR TO COMMENCING ANY CLEARING OR GRADING OF THE SITE. STRUCTURAL CONTROLS SHALL BE INSTALLED CONCURRENTLY WITH THE APPLICABLE ACTIVITY. AREAS WHERE CONSTRUCTION ACTIVITY TEMPORARILY CEASES FOR MORE THAN TWENTY ONE (21) DAYS WILL BE STABILIZED WITH A TEMPORARY SEED AND MULCH WITHIN FOURTEEN (14) DAYS OF THE LAST DISTURBANCE. ONCE CONSTRUCTION ACTIVITY CEASES PERMANENTLY IN AN AREA, SILT BARRIERS AND ANY EARTH/DIKES WILL BE REMOVED ONCE PERMANENT MEASURES ARE ESTABLISHED.

WASTE DISPOSAL

1. ALL WASTE MATERIALS WILL BE COLLECTED AND STORED IN SECURELY LIDDED RECEPTACLES. ALL TRASH AND CONSTRUCTION DEBRIS FROM THE SITE WILL BE DEPOSITED IN A DUMPSTER. NO CONSTRUCTION WASTE MATERIALS WILL BE BURIED ON SITE. ALL PERSONNEL WILL BE INSTRUCTED REGARDING THE CORRECT PROCEDURE FOR WASTE DISPOSAL BY THE SUPERINTENDENT.
2. HAZARDOUS WASTE ALL HAZARDOUS WASTE MATERIALS WILL BE DISPOSED OF IN THE MANNER SPECIFIED BY LOCAL OR STATE REGULATION OR BY THE MANUFACTURER. SITE PERSONNEL WILL BE INSTRUCTED IN THESE PRACTICES BY THE SUPERINTENDENT.
3. SANITARY WASTE ALL SANITARY WASTE WILL BE COLLECTED FROM THE PORTABLE UNITS A MINIMUM OF ONCE PER WEEK BY A LICENSED SANITARY WASTE MANAGEMENT CONTRACTOR.

SPILL PREVENTION

1. MATERIAL MANAGEMENT PRACTICES THE FOLLOWING ARE THE MATERIAL MANAGEMENT PRACTICES THAT WILL BE USED TO REDUCE THE RISK OF SPILLS OR OTHER ACCIDENTAL EXPOSURE OF MATERIALS AND SUBSTANCES DURING CONSTRUCTION TO STORMWATER RUNOFF:
 - A. AN EFFORT WILL BE MADE TO STORE ONLY SUFFICIENT AMOUNTS OF PRODUCTS TO DO THE JOB.
 - B. ALL MATERIALS STORED ON SITE WILL BE STORED IN A NEAT, ORDERLY MANNER IN THEIR PROPER (ORIGINAL IF POSSIBLE) CONTAINERS AND, IF POSSIBLE, UNDER A ROOF OR OTHER ENCLOSURE.
2. PRODUCT SPECIFICATION PRACTICES THE FOLLOWING PRODUCT SPECIFIC PRACTICES WILL BE FOLLOWED ON SITE:
 - A. MANUFACTURER'S RECOMMENDATIONS FOR PROPER USE AND DISPOSAL WILL BE FOLLOWED.
 - B. THE SITE SUPERINTENDENT WILL INSPECT DAILY TO ENSURE PROPER USE AND DISPOSAL OF MATERIALS.
 - C. SUBSTANCES WILL NOT BE MIXED WITH ONE ANOTHER UNLESS RECOMMENDED BY THE MANUFACTURER.
 - F. WHENEVER POSSIBLE ALL OF A PRODUCT WILL BE USED UP BEFORE DISPOSING OF THE CONTAINER.

GOOD HOUSEKEEPING: THE FOLLOWING GOOD HOUSEKEEPING PRACTICES WILL BE FOLLOWED ON SITE DURING THE CONSTRUCTION PROJECT:

- A. AN EFFORT WILL BE MADE TO STORE ONLY SUFFICIENT AMOUNTS OF PRODUCTS TO DO THE JOB.
- B. ALL MATERIALS STORED ON SITE WILL BE STORED IN A NEAT, ORDERLY MANNER IN THEIR PROPER (ORIGINAL IF POSSIBLE) CONTAINERS AND, IF POSSIBLE, UNDER A ROOF OR OTHER ENCLOSURE.
- C. MANUFACTURER'S RECOMMENDATIONS FOR PROPER USE AND DISPOSAL WILL BE FOLLOWED.
- D. THE SITE SUPERINTENDENT WILL INSPECT DAILY TO ENSURE PROPER USE AND DISPOSAL OF MATERIALS.
- E. SUBSTANCES WILL NOT BE MIXED WITH ONE ANOTHER UNLESS RECOMMENDED BY THE MANUFACTURER.
- F. WHENEVER POSSIBLE ALL OF A PRODUCT WILL BE USED UP BEFORE DISPOSING OF THE CONTAINER.

HAZARDOUS PRODUCTS: THE FOLLOWING PRACTICES WILL BE USED TO REDUCE THE RISKS ASSOCIATED WITH HAZARDOUS MATERIALS:

- A. PRODUCTS WILL BE KEPT IN THEIR ORIGINAL CONTAINERS UNLESS THEY ARE NOT RESEALABLE.
- B. ORIGINAL LABELS AND MATERIAL SAFETY DATA WILL BE RETAINED FOR IMPORTANT PRODUCT INFORMATION.
- C. SURPLUS PRODUCT THAT MUST BE DISPOSER OF WILL BE DISCARDED ACCORDING TO THE MANUFACTURER'S RECOMMENDED METHODS OF DISPOSAL.

HAZARDOUS PRODUCTS: THE FOLLOWING PRACTICES WILL BE USED TO REDUCE THE RISKS ASSOCIATED WITH HAZARDOUS MATERIALS:

PETROLEUM PRODUCTS: ALL ON SITE VEHICLES WILL BE MONITORED FOR LEAKS AND RECEIVE REGULAR PREVENTIVE MAINTENANCE TO REDUCE LEAKAGE. PETROLEUM PRODUCTS WILL BE STORED IN TIGHTLY SEALED CONTAINERS WHICH ARE CLEARLY LABELED. ANY ASPHALT BASED SUBSTANCES USED ON SITE WILL BE APPLIED ACCORDING TO THE MANUFACTURER'S RECOMMENDATIONS.

FERTILIZERS: FERTILIZERS USED WILL BE APPLIED ONLY IN THE MINIMUM AMOUNTS DIRECTED BY THE SPECIFICATIONS. ONCE APPLIED FERTILIZER WILL BE WORKED INTO THE SOIL TO LIMIT EXPOSURE TO STORMWATER. STORAGE WILL BE IN A COVERED SHED OR ENCLOSED TRAILERS. THE CONTENTS OF ANY PARTIALLY USED BAGS OF FERTILIZER WILL BE TRANSFERRED TO A SEALABLE PLASTIC BIN TO AVOID SPILLS.

PAINTS: ALL CONTAINERS WILL BE TIGHTLY SEALED AND STORED WHEN NOT REQUIRED FOR USE. EXCESS PAINT WILL NOT BE DISCHARGED TO THE STORM SEWER SYSTEM BUT WILL BE DISPOSER OF PROPERLY ACCORDING TO MANUFACTURER'S INSTRUCTIONS OR STATE AND LOCAL REGULATIONS.

CONCRETE TRUCKS: CONCRETE TRUCKS WILL DISCHARGE AND WASH OUT SURPLUS CONCRETE OR DRUM WASH WATER IN A CONTAINED AREA DESIGNATED ON SITE.

SPILL CONTROL PRACTICES

IN ADDITION TO GOOD HOUSEKEEPING AND MATERIAL MANAGEMENT PRACTICES DISCUSSED IN THE PREVIOUS SECTION THE FOLLOWING PRACTICES WILL BE FOLLOWED FOR SPILL PREVENTION AND CLEANUP:

- A. MANUFACTURER'S RECOMMENDED METHODS FOR SPILL CLEANUP WILL BE CLEARLY POSTED AND SITE PERSONNEL WILL BE MADE AWARE OF THE PROCEDURES AND THE LOCATION OF THE INFORMATION AND CLEANUP SUPPLIES.
- B. MATERIALS AND EQUIPMENT NECESSARY FOR SPILL CLEANUP WILL BE KEPT IN THE MATERIAL STORAGE AREA ON SITE. EQUIPMENT AND MATERIALS WILL INCLUDE BUT NOT BE LIMITED TO BROOMS, DUSTPANS, MOPS, RAGS, GLOVES, GOGGLES, KITTY LITTER, SAND, SAWDUST AND PLASTIC OR METAL TRASH CONTAINERS SPECIFICALLY FOR THIS PURPOSE.
- C. ALL SPILLS WILL BE CLEANED UP IMMEDIATELY AFTER DISCOVERY.
- D. THE SPILL AREA WILL BE KEPT WELL VENTILATED AND PERSONNEL WILL WEAR APPROPRIATE PROTECTIVE CLOTHING TO PREVENT INJURY FROM CONTACT WITH A HAZARDOUS SUBSTANCE.
- E. SPILLS OF TOXIC OR HAZARDOUS MATERIAL WILL BE REPORTED TO THE APPROPRIATE STATE OR LOCAL GOVERNMENT AGENCY, REGARDLESS OF THE SIZE.
- F. THE SPILL PREVENTION PLAN WILL BE ADJUSTED TO INCLUDE MEASURES TO PREVENT THIS TYPE OF SPILL FROM RECURRING AND HOW TO CLEANUP THE SPILL IF IT RECURS. A DESCRIPTION OF THE SPILL, ITS CAUSE, AND THE CLEANUP MEASURES WILL BE INCLUDED.
- G. THE SITE SUPERINTENDENT RESPONSIBLE FOR DAY-TO-DAY SITE OPERATIONS WILL BE THE SPILL PREVENTION AND CLEANUP COORDINATOR.

DUST CONTROL

THE CONTRACTOR SHALL BE RESPONSIBLE TO CONTROL DUST THROUGHOUT THE CONSTRUCTION PERIOD. DUST CONTROL METHODS SHALL INCLUDE, BUT NOT LIMITED TO SPRINKLING WATER ON EXPOSED AREAS, COVERING LOADED DUMP TRUCKS LEAVING THE SITE, AND TEMPORARY MULCHING. DUST CONTROL MEASURES SHALL BE UTILIZED SO AS TO PREVENT THE MIGRATION OF DUST FROM THE SITE TO ADJACENT AREAS.

May 28, 2020 - 12:02pm F:\MISC Projects\47361 - Green & Co - Banfield Road\Design\Production\Drawings\Notes.dwg

Copyright 2019 ©Thomas F. Moran, Inc. 48 Constitution Drive, Bedford, N.H. 03110

All rights reserved. These plans and materials may not be copied, duplicated, replicated or otherwise reproduced in any form whatsoever without the prior written permission of Thomas F. Moran, Inc.

This plan is not effective unless signed by a duly authorized officer of Thomas F. Moran, Inc.



SITE DEVELOPMENT PLANS

TAX MAP 256 LOT 2
EROSION CONTROL NOTES
THE VILLAGE AT BANFIELD WOODS
PORTSMOUTH, NH

OWNED BY
WALTER D HETT TRUST
PREPARED FOR
GREEN & COMPANY REAL ESTATE

SCALE: NTS SEPTEMBER 25, 2019



Civil Engineers
Structural Engineers
Traffic Engineers
Land Surveyors
Landscape Architects
Scientists

48 Constitution Drive
Bedford, NH 03110
Phone (603) 472-4488
Fax (603) 472-9747
www.tfmoran.com

REV	DATE	DESCRIPTION	DR	CK
6	5/5/2020	AoT SUBMITTAL	RCK	JJM
5	4/29/2020	REVISER PER REGULATORY COMMENTS	RCK	JJM
4	3/20/2020	PROGRESS PRINT	RCK	JJM
3	3/4/2020	UPDATE PLANS PER REGULATORY COMMENTS	RCK	JJM
2	12/27/2019	IN HOUSE REVISIONS	RCK	JJM
1	12/23/19	NO REVISIONS THIS SHEET	RCK	JJM
REV	DATE	DESCRIPTION	DR	CK

F	47361.00	DR	RCK	FB	-	NOTES	C-26
E		CK	JJM	CADFILE			

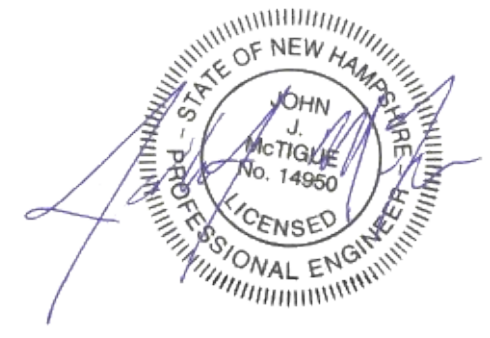

May 28, 2020 - 12:03pm F:\MISC Projects\47381 - Portsmouth - Banfield Road - Portsmouth\47381-00 - Green & Co - Banfield Road\Design\Production Drawings\Wetland Crossing Sequence.dwg

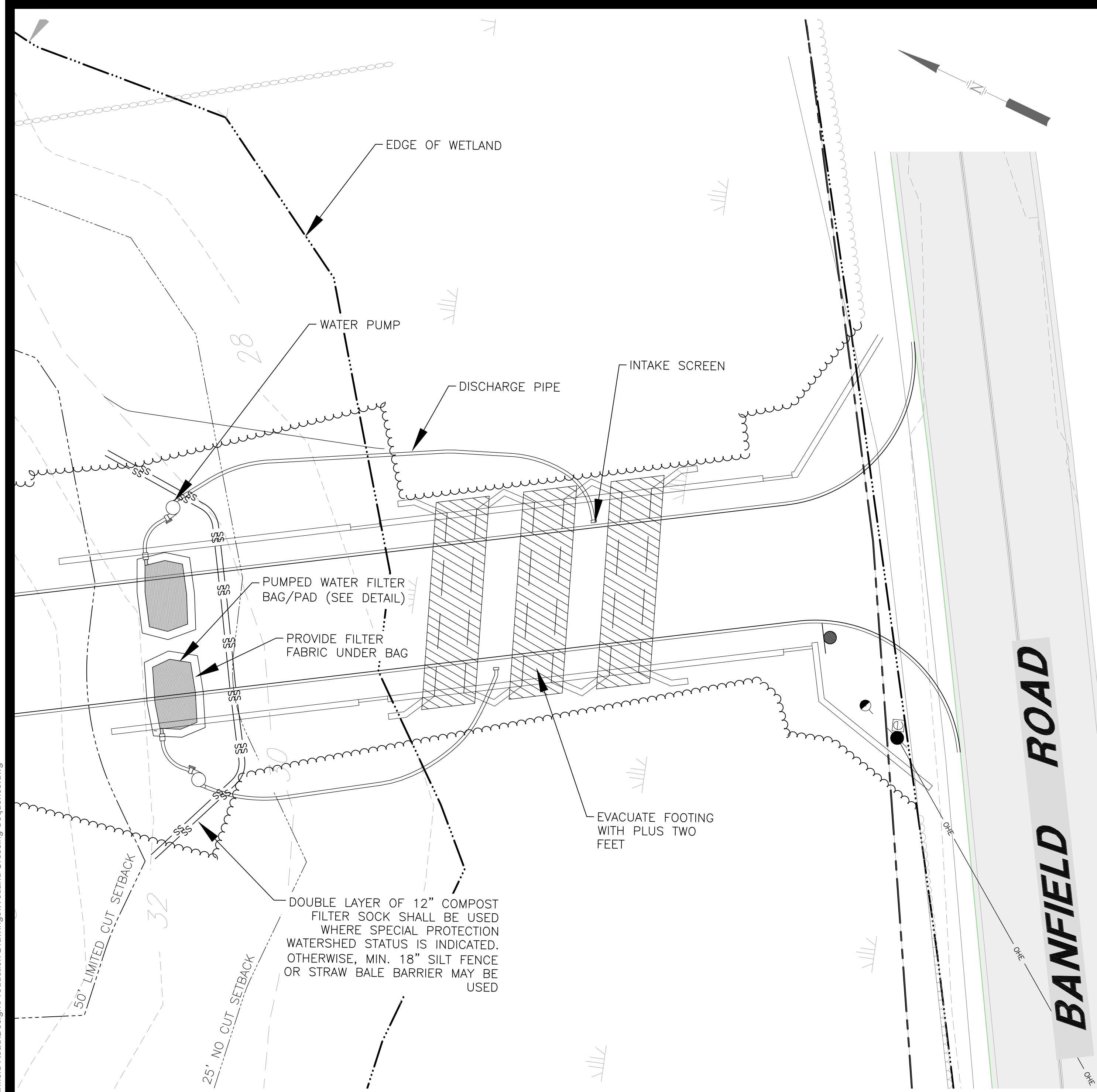

TYPICAL WETLAND CROSSING - OPEN TRENCH
NOT TO SCALE

- NOTES:**
- GRUBBING SHALL NOT TAKE PLACE BEYOND THE LIMIT OF WORK AS SHOWN ON THE APPROVED PLANS.
 - WATER ACCUMULATING WITH IN THE WORK AREA SHALL BE PUMPED TO A SEDIMENT BAG OR SEDIMENT TRAP PRIOR TO DISCHARGING.
 - HAZARDOUS OR POLLUTANT MATERIAL STORAGE AREAS AND EQUIPMENT REFUELING AREAS SHALL BE LOCATED AT LEAST 100' BACK FROM THE EDGE OF WETLAND.
 - ALL EXCESS EXCAVATED MATERIAL SHALL BE IMMEDIATELY REMOVED FROM THE EDGE OR WETLAND.
 - ALL DISTURBED AREAS WITHIN 50' OF THE EDGE OF WETLAND SHALL BE BLANKETED OR MATTED WITHIN 24 HOURS OF INITIAL DISTURBANCE UNLESS OTHERWISE AUTHORIZED. APPROPRIATE WETLAND PROTECTION SHALL BE PROVIDED WITHIN THE CHANNEL.
 - PROVIDE SECONDARY CONTAINMENT TO CAPTURE DRIPS, SPILLS, OR LEAKS OF FUEL OR OIL.

- WETLAND CROSSING -- SEQUENCE OF CONSTRUCTION**
- THE PLACEMENT OF THESE STRUCTURES WILL BE DONE IN THE ORDER AS NUMBERED BELOW. EACH SEQUENCE BELOW WILL BE COMPLETED BEFORE THE NEXT STEP IN THE SEQUENCE COMMENCES. NO STEPS WILL BE REMOVED.
- THE TIME OF WETLAND DISTURBANCE WILL BE LIMITED AND WILL BE SCHEDULED DURING LOW FLOW OR NO FLOW CONDITIONS.
- AT WETLAND CROSSING, THE WETLAND BUFFER SHALL BE MAINTAINED TO THE LARGEST EXTENT FEASIBLE. CLEARING, SOIL DISTURBANCE, EXCAVATION, AND EQUIPMENT TRAFFIC SHOULD BE MINIMIZED. ACTIVITIES SUCH AS STACKING CUT LOGS, DISCHARGING RAIN WATER FROM TRENCHES, WELDING PIPE JOINTS, STORING PIPE SECTIONS, REFUELING AND MAINTAINING EQUIPMENT SHOULD BE ACCOMPLISHED OUTSIDE OF THESE BUFFERS.
 - INSTALL APPROPRIATE SEDIMENT BARRIER DOWNSLOPE OF ALL SPOIL/EXCAVATION FROM CROSSING AREAS PRIOR TO THE COMMENCEMENT OF CONSTRUCTION.
 - THE SEDIMENT BARRIER FOR THE SPOIL CROSSING AREAS MUST BE A MINIMUM OF 10' FROM THE EDGE OF WETLAND
 - INSTALL WATER PUMP. IF A LEVEL AREA IS REQUIRED, GRADE THE PUMP AREA, THEN PLACE A 4" LAYER OF #57 STONE OR REINFORCED EROSION CONTROL BLANKET.
 - DURING THE EXCAVATION FOR THE PLACEMENT OF THE WETLAND CROSSING:
 - ALL WATER THAT NEEDS TO BE PUMPED FROM THE EXCAVATED TRENCH AREA WILL BE REMOVED BY DISCHARGE THROUGH A PUMPED WATER FILTER BAG. SEE FILTER BAG PAD DETAIL.
 - IF THE AREA THAT THE BAG IS PLACED ON IS GREATER THAN 5% SLOPE, THEN A PUMPED WATER FILTER BAG PAD WILL BE CONSTRUCTED. SEE SEDIMENT FILTER BAG WITH GRAVEL PAD DETAIL.
 - EXCAVATE MATERIAL FOR TRENCH AREA. THE MATERIAL WILL THEN BE PLACED IN A DESIGNATED AREAS FOR LATER USE. KEEP WETLAND TOPSOIL SEPARATE FOR LATER USE.
 - INSTALL CROSSING
 - INSTALL ECOPASSAGE FOOTING.
 - INSTALL ECOPASSAGE.
 - INSTALL CONDUITS FOR UTILITIES.
 - BACKFILL WILL THEN BE PLACED AROUND AND/OR ON THE ECOPASSAGES. BACK FILL SHALL BE COMPACTED IN A MAXIMUM OF 12" LIFTS.
 - THE WETLAND AND SURROUNDING AREA NOT BEING DEVELOPED WILL BE RESTORED TO ORIGINAL CONTOURS. ALL DISTURBED AREAS WILL BE SEEDED AND MULCHED.
 - THE PUMPING OF WATER TO THE WATER FILTER BAG AS SHOWN IN STEP 4 OF THE INSTALLATION WILL CONTINUE DURING RESTORATION PROCEDURES.
 - THE SPOIL FROM CROSSING PLACEMENT AREAS WILL BE REGRADED, SEEDED AND MULCHED.
 - THE SILT BARRIER SHALL BE PLACED DOWN GRADIENT OF THE SPOIL STORAGE AREA AND WILL REMAIN IN PLACE AND MAINTAINED UNTIL PERMANENT VEGETATED STABILIZATION IS ACHIEVED.
 - PERMANENT STABILIZATION WILL BE ACHIEVED WHEN A UNIFORM 85% VEGETATIVE COVER OF THE ENTIRE SEEDED AREA IS ESTABLISHED.
 - REMOVE PUMPED WATER FILTER BAGS. THE AREA UTILIZED FOR THE PUMPED WATER FILTER BAG/PAD WILL BE REGRADED, SEEDED AND MULCHED.
 - THE PUMPING AREA AS SHOWN IN INSTALLATION SEQUENCE 4 WILL BE REGRADED, SEEDED AND MULCHED.
 - ALL AREAS THAT WERE DISTURBED DURING THE CONSTRUCTION OF THE WETLAND CROSSING WILL BE RETURNED TO THEIR ORIGINAL CONTOURS. SILT BARRIERS WILL BE PLACED DOWNSLOPE OF ANY AREAS THAT WILL BE REGRADED. THE AREAS WILL BE SEEDED AND MULCHED AS PER THE EROSION CONTROL NOTES. WILL REMAIN IN PLACE AND MAINTAINED UNTIL PERMANENT VEGETATED STABILIZATION IS ACHIEVED.
 - UPON COMPLETION OF AN EARTH DISTURBANCE ACTIVITY OR ANY STAGE OR PHASE OF AN ACTIVITY, THE SITE SHALL BE IMMEDIATELY SEEDED, MULCHED, OR OTHERWISE PROTECTED FROM ACCELERATED EROSION AND SEDIMENTATION.

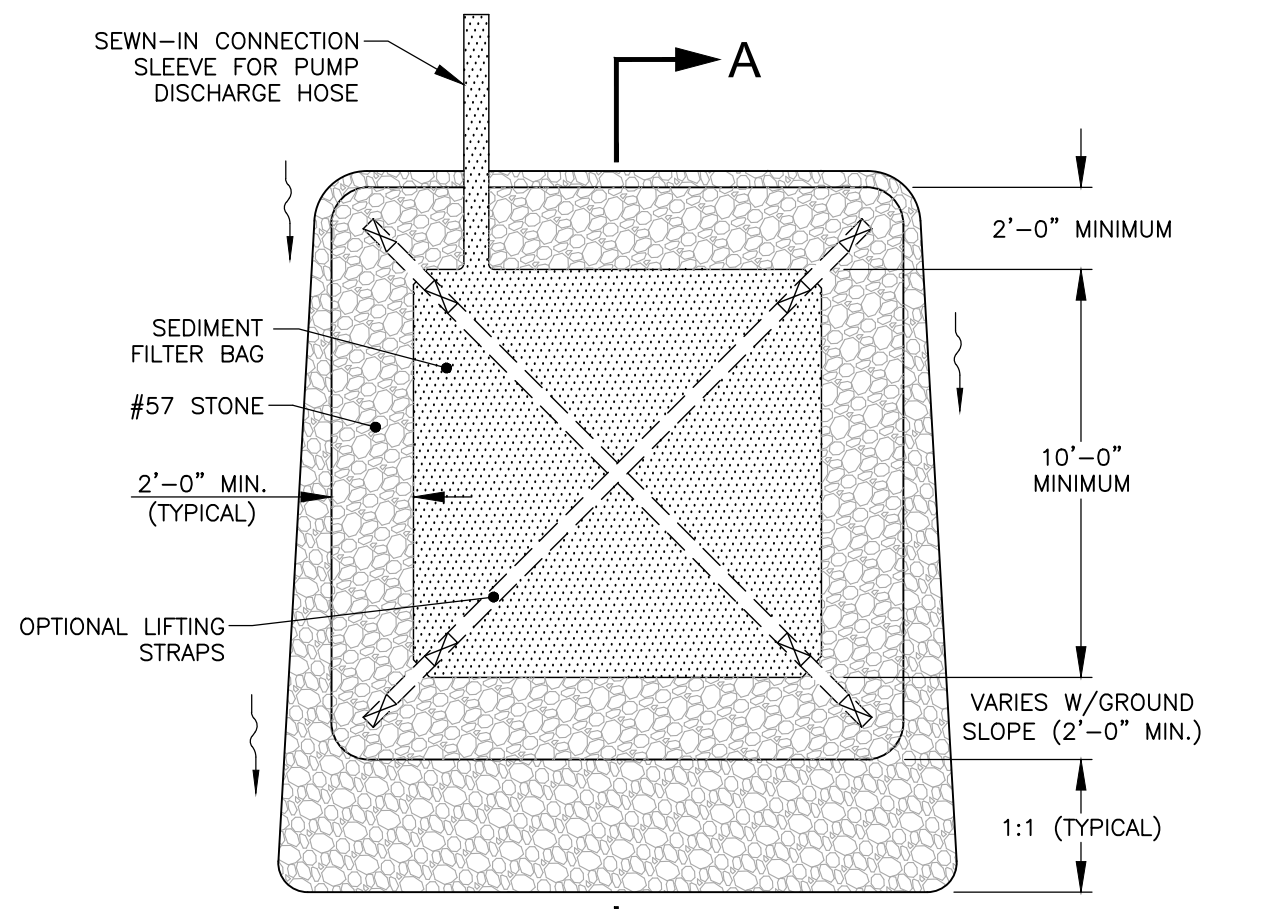

PLAN VIEW

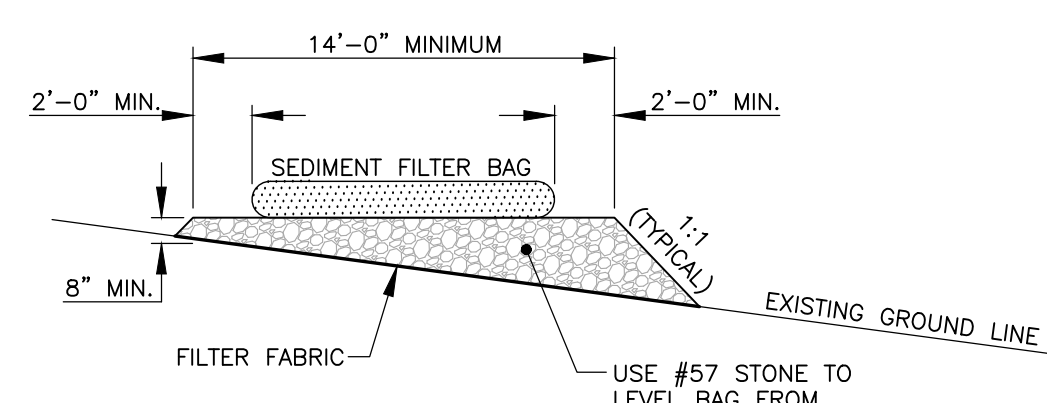

SECTION A-A

SEDIMENT FILTER BAG WITH GRAVEL PAD
NOT TO SCALE

- SEDIMENT FILTER BAG GENERAL NOTES:**
- CONTRACTOR SHALL EXERCISE CAUTION NOT TO BURST OR DAMAGE THE SEDIMENT FILTER BAG WHEN PUMPING.
 - THE LENGTH AND WIDTH OF THE TEMPORARY SEDIMENT BAG SHOWN ON THIS DRAWING MAY VARY PER VENDOR SPECIFICATIONS. THE MINIMUM "FOOTPRINT" OF THE BAG SHALL BE 10 x 15 FEET.
 - SEDIMENT FILTER BAGS SHALL BE EQUIPPED WITH A SEWN-IN SLEEVE OF SUFFICIENT SIZE TO ACCEPT A MINIMUM 4 INCH DIAMETER PUMP DISCHARGE HOSE. THE DISCHARGE HOSE SHOULD BE EXTENDED INTO THIS SLEEVE A MINIMUM OF 6 INCHES AND BE TIGHTLY SECURED WITH A HOSE CLAMP OR OTHER SUITABLE MEANS TO PREVENT LEAKAGE. HOSE CONNECTION THROUGH A SLIT IN THE BAG WILL NOT BE ACCEPTABLE.
 - THE PUMP DISCHARGE HOSE CONNECTION SLEEVE SHALL BE SECURELY TIED OFF DURING DISPOSAL OF THE SEDIMENT FILTER BAG IN ORDER TO PREVENT LEAKAGE OF COLLECTED SEDIMENTS.
 - SEDIMENT FILTER BAG SHALL BE MAINTAINED AND REPLACED WHEN ONE HALF FULL OF SEDIMENT OR IN ACCORDANCE WITH THE MANUFACTURER'S RECOMMENDATIONS.

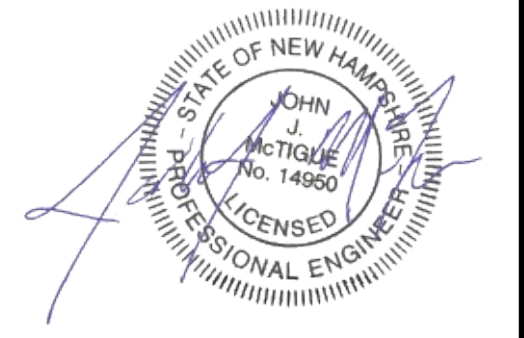

SITE DEVELOPMENT PLANS

TAX MAP 256 LOT 2
WETLAND CROSSING PLAN
THE VILLAGE AT BANFIELD WOODS
PORTSMOUTH, NH

OWNED BY
WALTER D HETT TRUST
PREPARED FOR
GREEN & COMPANY REAL ESTATE

SCALE: NTS **SEPTEMBER 25, 2019**

Copyright 2019 © Thomas F. Moran, Inc.
48 Constitution Drive, Bedford, N.H. 03110

All rights reserved. These plans and materials may not be copied, duplicated, replicated or otherwise reproduced in any form whatsoever without the prior written permission of Thomas F. Moran, Inc.

This plan is not effective unless signed by a duly authorized officer of Thomas F. Moran, Inc.



REV	DATE	DESCRIPTION	DR	CK
6	5/5/2020	AoT SUBMITTAL	RCK	JJM
5	4/29/2020	REVISOR PER REGULATORY COMMENTS	RCK	JJM
4	3/20/2020	PROGRESS PRINT	RCK	JJM
3	3/4/2020	UPDATE PLANS PER REGULATORY COMMENTS	RCK	JJM
2	12/27/2019	IN HOUSE REVISIONS	RCK	JJM
1	12/23/19	NO REVISIONS THIS SHEET	RCK	JJM
REV DATE DESCRIPTION DR CK				

TFM Civil Engineers
Structural Engineers
Traffic Engineers
Land Surveyors
Landscape Architects
Scientists

48 Constitution Drive
Bedford, NH 03110
Phone (603) 472-4488
Fax (603) 472-9747
www.tfmoran.com

47361.00 DR RCK FB
CK JJM CADFILE WETLAND CROSSING SEQUENCE

C-27

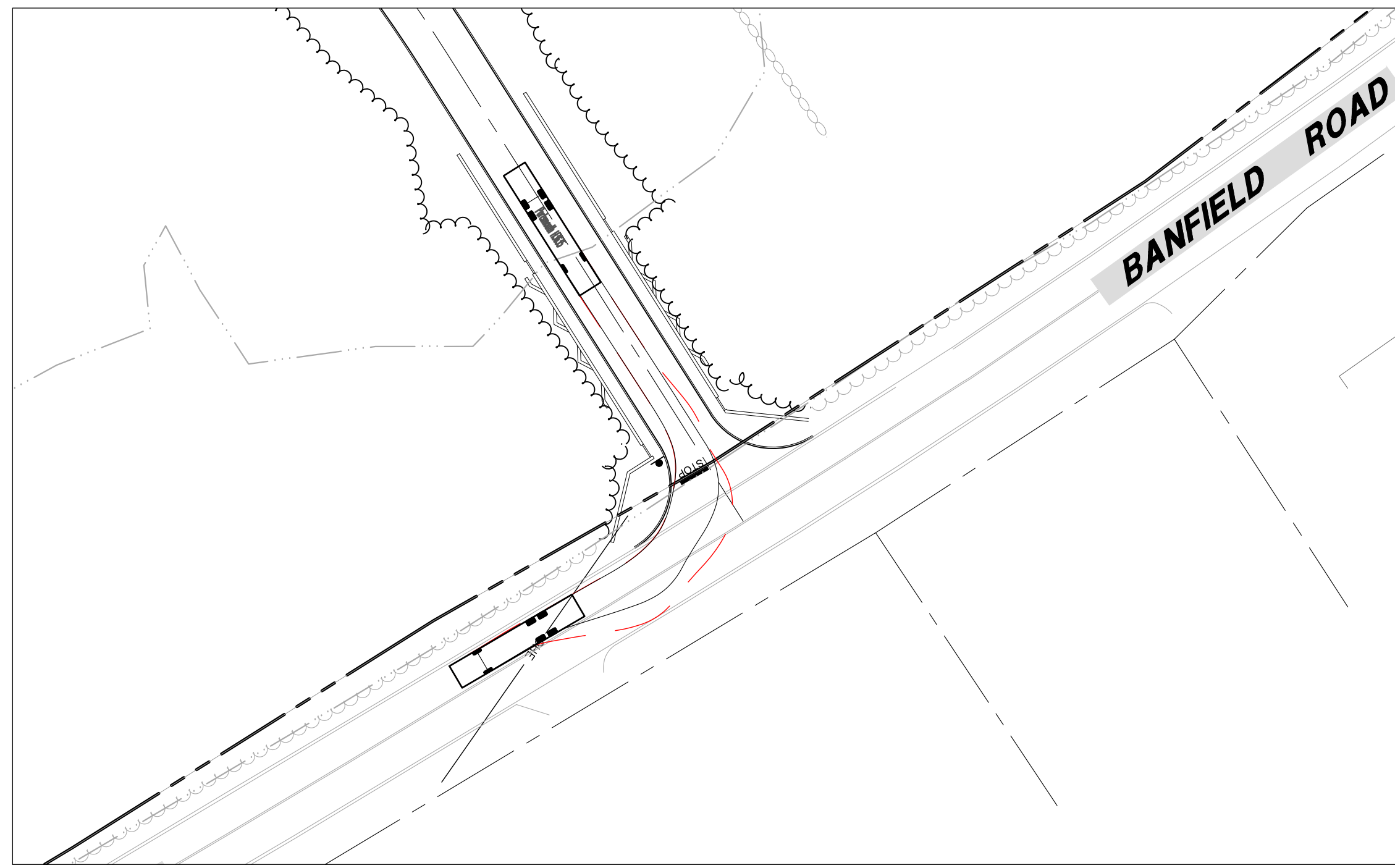

FIRE TRUCK TURNING FROM ROAD-A SOUTHWEST ONTO BANFIELD ROAD

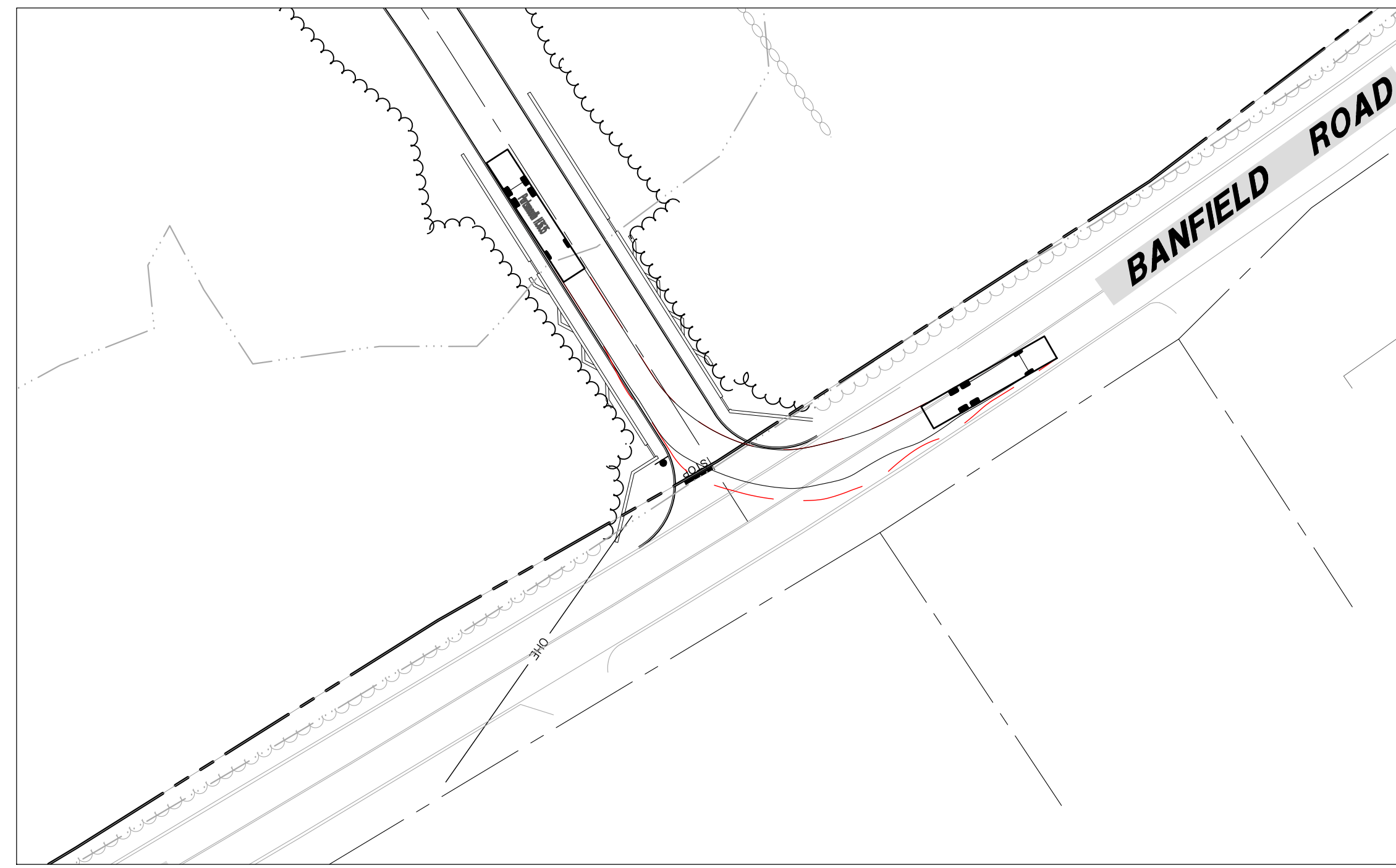

FIRE TRUCK TURNING FROM ROAD-A NORTHEAST ONTO BANFIELD ROAD

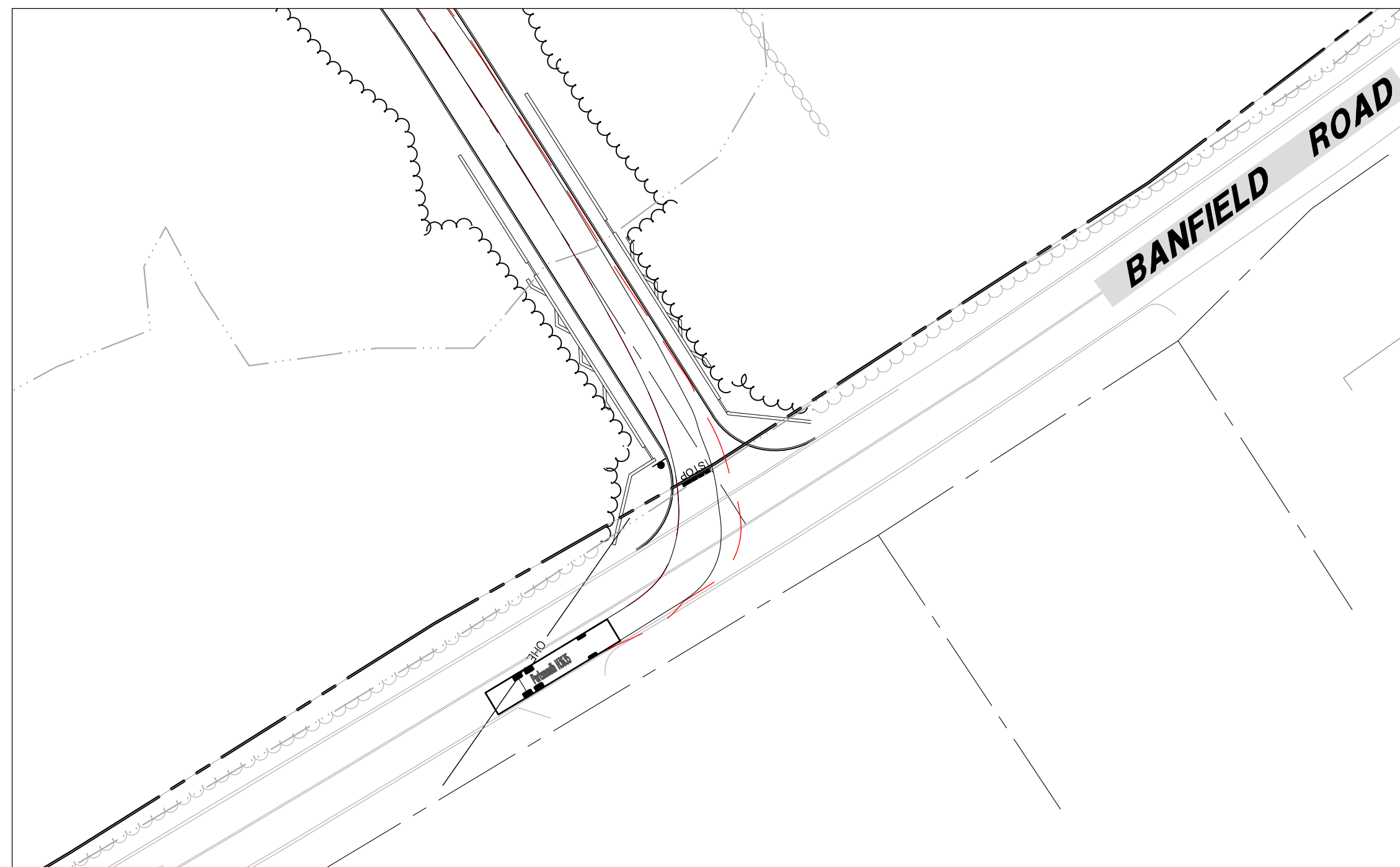

FIRE TRUCK DRIVING NORTHEAST TURNING ONTO ROAD-A

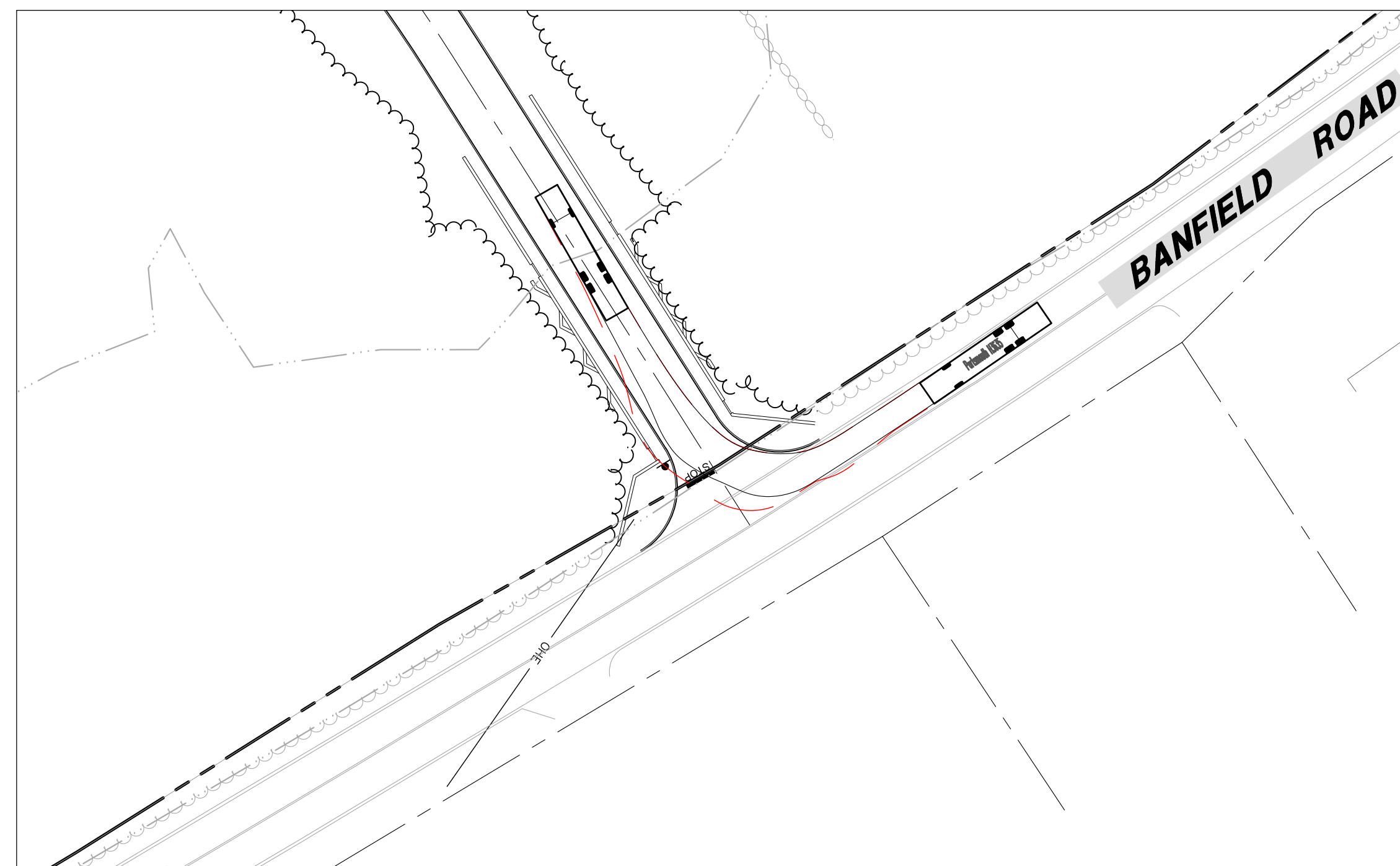

FIRE TRUCK DRIVING SOUTHWEST TURNING ONTO ROAD-A

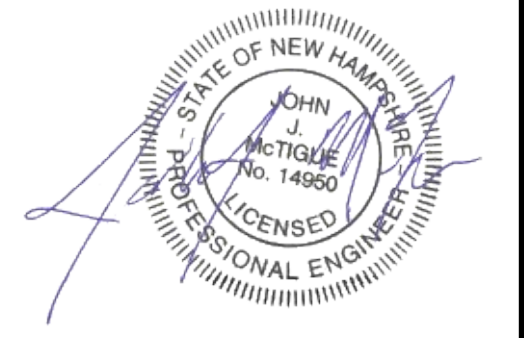
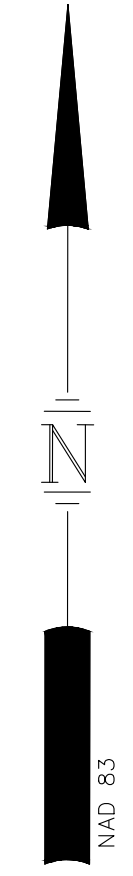

SITE DEVELOPMENT PLANS
 TAX MAP 256 LOT 2
FIRE TRUCK MOVEMENT PLAN
THE VILLAGE AT BANFIELD WOODS
PORTSMOUTH, NH
 OWNED BY
WALTER D HETT TRUST
 PREPARED FOR
GREEN & COMPANY REAL ESTATE
 SCALE: NTS SEPTEMBER 25, 2019

REV	DATE	DESCRIPTION	DR	CK
6	5/5/2020	AoT SUBMITTAL	RCK	JJM
5	4/29/2020	REVISER PER REGULATORY COMMENTS	RCK	JJM
4	3/20/2020	PROGRESS PRINT	RCK	JJM
3	3/4/2020	UPDATE PLANS PER REGULATORY COMMENTS	RCK	JJM
2	12/27/2019	IN HOUSE REVISIONS	RCK	JJM
1	12/23/19	NO REVISIONS THIS SHEET	RCK	JJM

TFM Civil Engineers
 Structural Engineers
 Traffic Engineers
 Land Surveyors
 Landscape Architects
 Scientists

48 Constitution Drive
 Bedford, NH 03110
 Phone (603) 472-4488
 Fax (603) 472-9747
 www.tfmoran.com

47361.00 DR RCK FB
 CK JMM CADFILE TRUCK MOVEMENT C-28

Copyright 2019 © Thomas F. Moran, Inc.
 48 Constitution Drive, Bedford, N.H. 03110
 All rights reserved. These plans and materials may not be copied, duplicated, replicated or otherwise reproduced in any form whatsoever without the prior written permission of Thomas F. Moran, Inc.
 This plan is not effective unless signed by a duly authorized officer of Thomas F. Moran, Inc.



May 28, 2020 - 12:04pm F:\MISC Projects\47361 - Portsmouth\47361-00 - Green & Co - Banfield Road - Production\Drawings\Truck Movement.dwg

May 28, 2020 - 12:04pm F:\MISC Projects\47381 - Banfield Road - Portsmouth\47381-00 - Green & Co - Banfield Road\Design\Production Drawings\Truck Movement.dwg

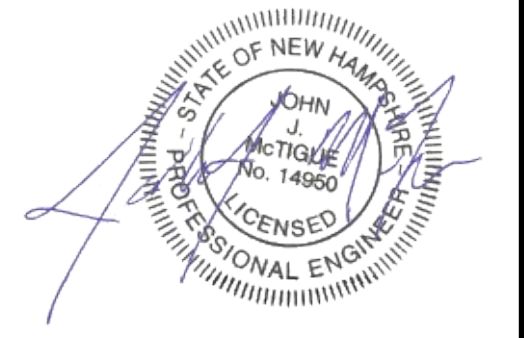
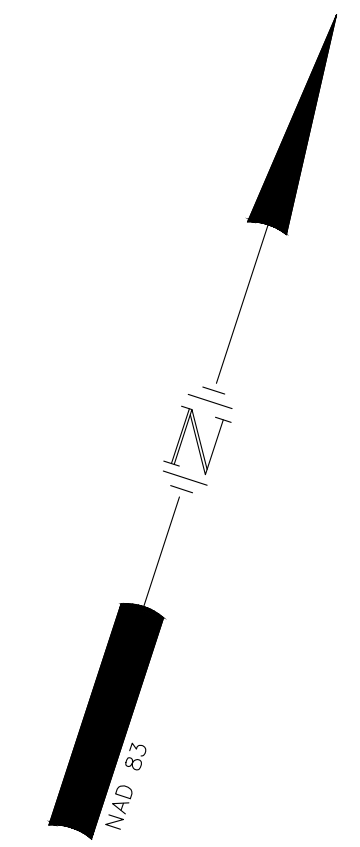
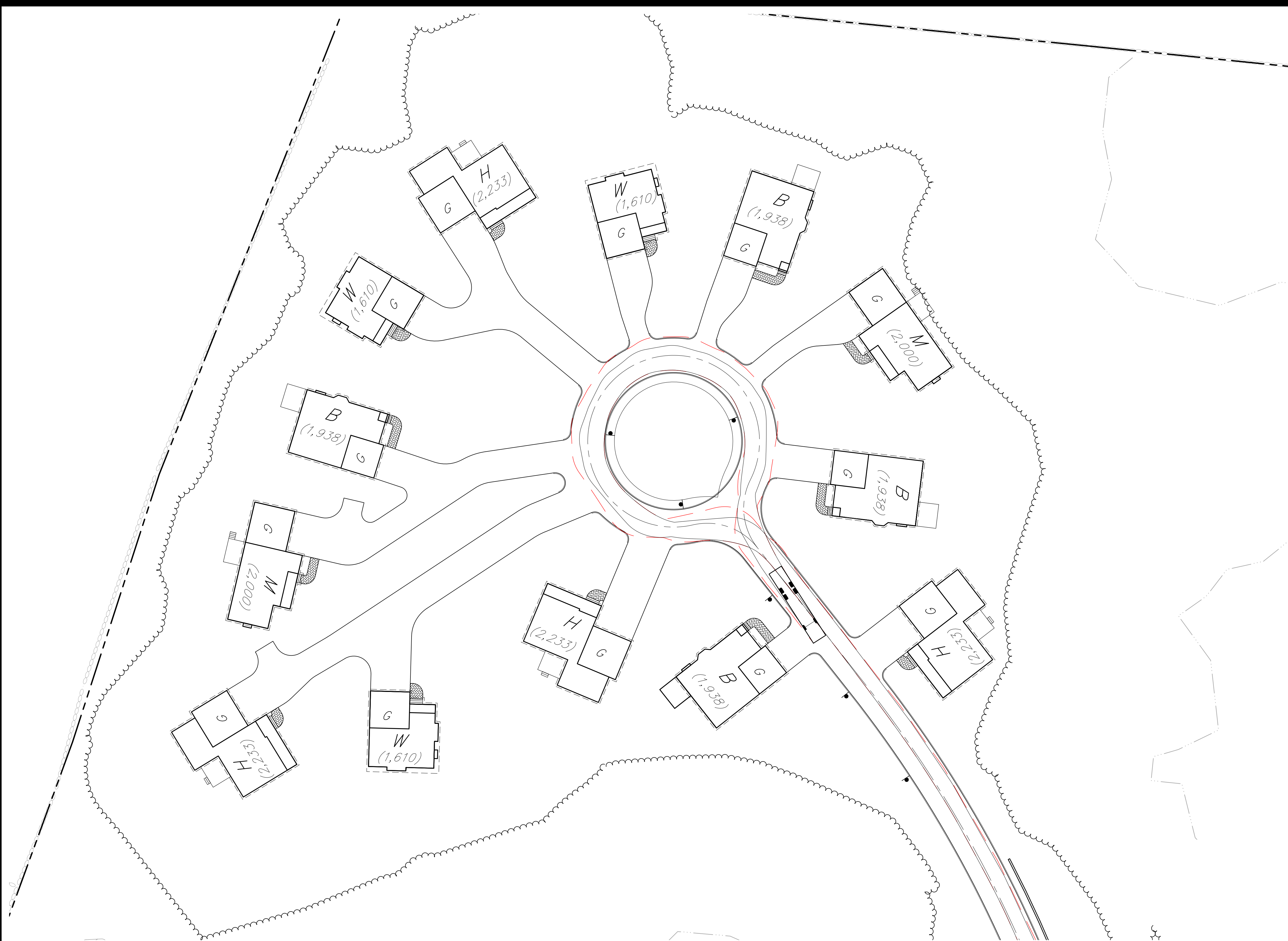

SITE DEVELOPMENT PLANS
 TAX MAP 256 LOT 2
FIRE TRUCK MOVEMENT PLAN
THE VILLAGE AT BANFIELD WOODS
PORTSMOUTH, NH
 OWNED BY
WALTER D HETT TRUST
 PREPARED FOR
GREEN & COMPANY REAL ESTATE
1"=60' (11"X17")
SCALE: 1"=30' (22"X34") **SEPTEMBER 25, 2019**

Copyright 2019 © Thomas F. Moran, Inc.
 48 Constitution Drive, Bedford, N.H. 03110
 All rights reserved. These plans and materials may not be copied, duplicated, replicated or otherwise reproduced in any form whatsoever without the prior written permission of Thomas F. Moran, Inc.
 This plan is not effective unless signed by a duly authorized officer of Thomas F. Moran, Inc.

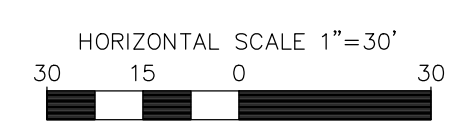

REV	DATE	DESCRIPTION	DR	CK
6	5/5/2020	AoT SUBMITTAL	RCK	JJM
5	4/29/2020	REVISOR PER REGULATORY COMMENTS	RCK	JJM
4	3/20/2020	PROGRESS PRINT	RCK	JJM
3	3/4/2020	UPDATE PLANS PER REGULATORY COMMENTS	RCK	JJM
2	12/27/2019	IN HOUSE REVISIONS	RCK	JJM
1	12/23/19		RCK	JJM

TFM	Civil Engineers Structural Engineers Traffic Engineers Land Surveyors Landscape Architects Scientists			48 Constitution Drive Bedford, NH 03110 Phone (603) 472-4488 Fax (603) 472-9747 www.tfmoran.com	
	DR	RCK	FB		
47361.00	CK	JJM	CADFILE	TRUCK MOVEMENT	C-29

May 28, 2020 - 12:05pm F:\MISC Projects\47361 - Portsmouth\47361-00 - Green & Co - Banfield Road\Design\Production Drawings\Truck Movement Driveways.dwg

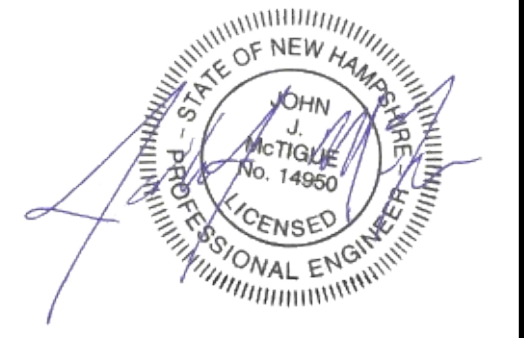
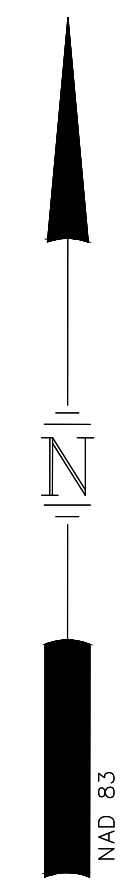
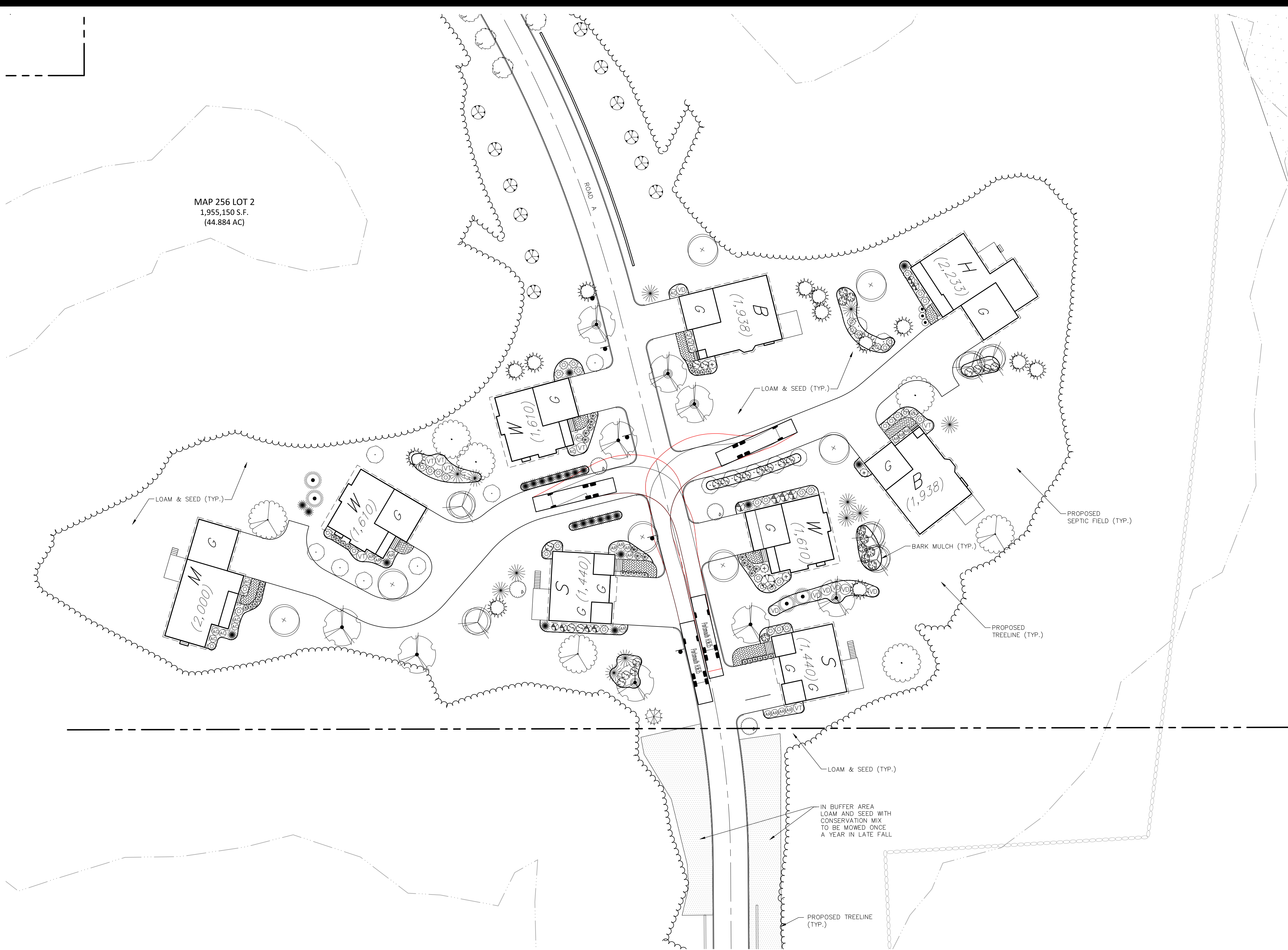

SITE DEVELOPMENT PLANS
 TAX MAP 256 LOT 2
FIRE TRUCK MOVEMENT PLAN
THE VILLAGE AT BANFIELD WOODS
PORTSMOUTH, NH
 OWNED BY
WALTER D HETT TRUST
 PREPARED FOR
GREEN & COMPANY REAL ESTATE

SCALE: NTS **SEPTEMBER 25, 2019**

Copyright 2019 © Thomas F. Moran, Inc.
 48 Constitution Drive, Bedford, N.H. 03110
 All rights reserved. These plans and materials may not be copied, duplicated, replicated or otherwise reproduced in any form whatsoever without the prior written permission of Thomas F. Moran, Inc.
 This plan is not effective unless signed by a duly authorized officer of Thomas F. Moran, Inc.



REV	DATE	DESCRIPTION	DR	CK
6	5/5/2020	AoT SUBMITTAL	RCK	JJM
5	4/29/2020	REVISOR PER REGULATORY COMMENTS	RCK	JJM
4	3/20/2020	PROGRESS PRINT	RCK	JJM
3	3/4/2020	UPDATE PLANS PER REGULATORY COMMENTS	RCK	JJM
2	12/27/2019	IN HOUSE REVISIONS	RCK	JJM
1	12/23/19	NO REVISIONS THIS SHEET	RCK	JJM

TFM Civil Engineers
 Structural Engineers
 Traffic Engineers
 Land Surveyors
 Landscape Architects
 Scientists

48 Constitution Drive
 Bedford, NH 03110
 Phone (603) 472-4488
 Fax (603) 472-9747
 www.tfmoran.com

47361.00 DR RCK FB
 CK JMM CADFILE TRUCK MOVEMENT DRIVEWAYS C-30

May 28, 2020 - 12:05pm F:\MISC Projects\47361 - Portsmouth\47361-00 - Green & Co - Banfield Road\Design\Production Drawings\Truck Movement Driveways.dwg

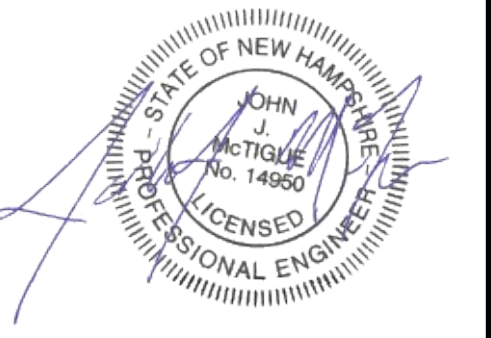
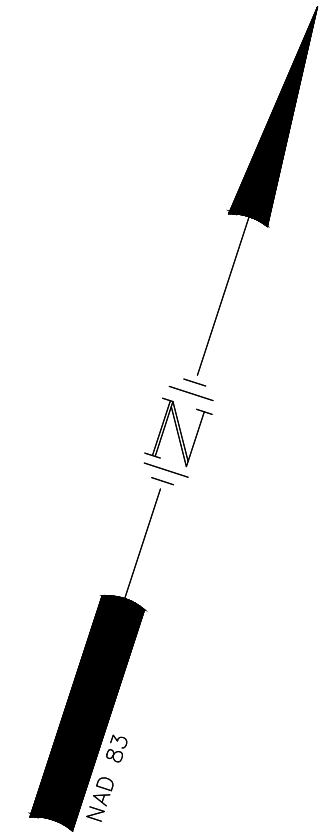
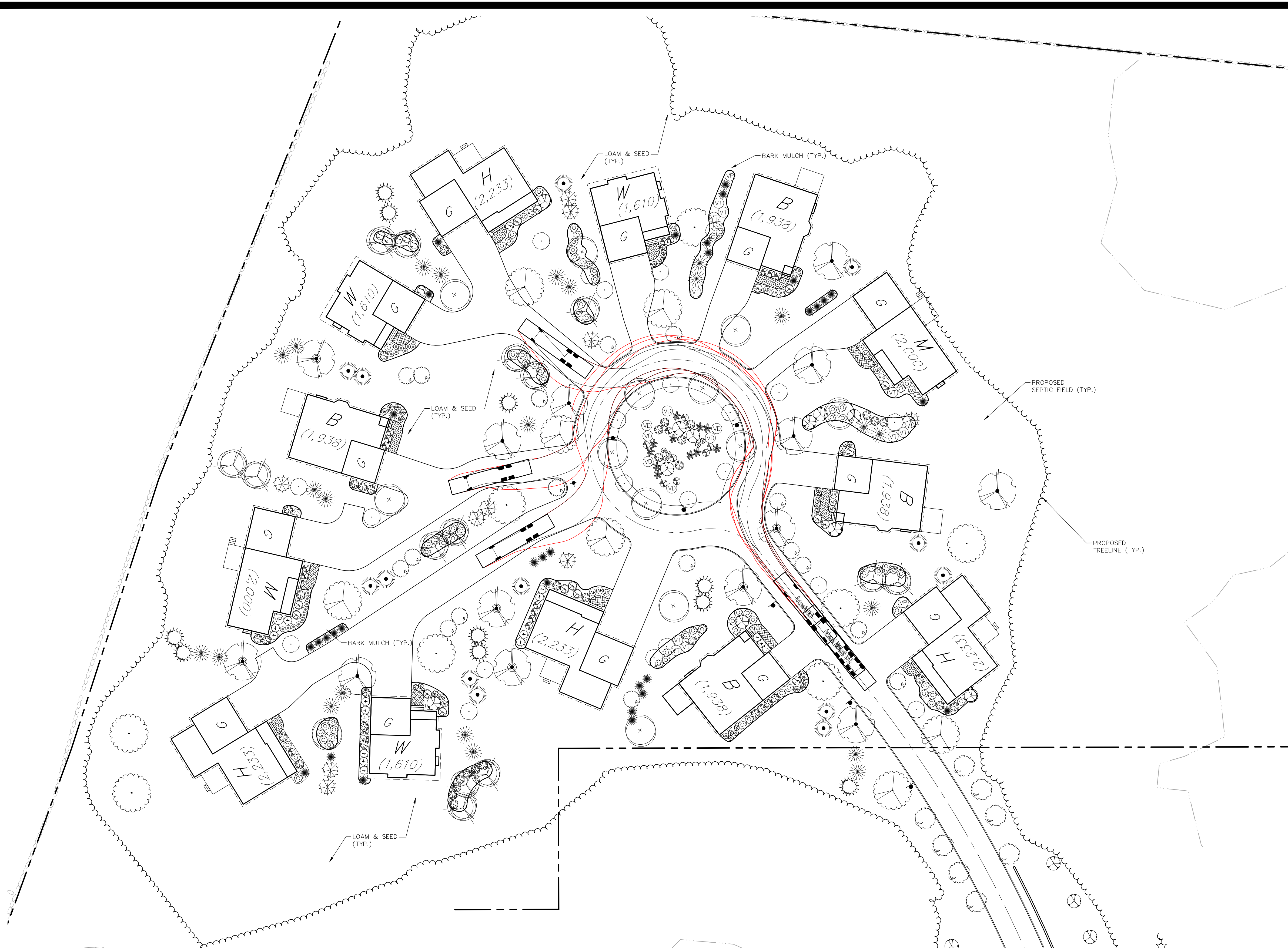

SITE DEVELOPMENT PLANS
 TAX MAP 256 LOT 2
FIRE TRUCK MOVEMENT PLAN
THE VILLAGE AT BANFIELD WOODS
PORTSMOUTH, NH
 OWNED BY
WALTER D HETT TRUST
 PREPARED FOR
GREEN & COMPANY REAL ESTATE
1"=60' (11"X17")
SCALE: 1"=30' (22"X34") **SEPTEMBER 25, 2019**

Copyright 2019 © Thomas F. Moran, Inc.
 48 Constitution Drive, Bedford, N.H. 03110
 All rights reserved. These plans and materials may not be copied, duplicated, replicated or otherwise reproduced in any form whatsoever without the prior written permission of Thomas F. Moran, Inc.
 This plan is not effective unless signed by a duly authorized officer of Thomas F. Moran, Inc.



HORIZONTAL SCALE 1"=30'
 30 15 0 30

REV	DATE	DESCRIPTION	DR	CK
6	5/5/2020	AoT SUBMITTAL	RCK	JJM
5	4/29/2020	REVISOR PER REGULATORY COMMENTS	RCK	JJM
4	3/20/2020	PROGRESS PRINT	RCK	JJM
3	3/4/2020	UPDATE PLANS PER REGULATORY COMMENTS	RCK	JJM
2	12/27/2019	IN HOUSE REVISIONS	RCK	JJM
1	12/23/19		RCK	JJM

TFM	Civil Engineers	48 Constitution Drive
	Structural Engineers	Bedford, NH 03110
	Traffic Engineers	Phone (603) 472-4488
	Land Surveyors	Fax (603) 472-9747
	Landscape Architects	www.tfmoran.com
	Scientists	

FILE #	47361.00	DR	RCK	FB	-	TRUCK MOVEMENT DRIVEWAYS	C-31
REV		CK	JJM	CADFILE			

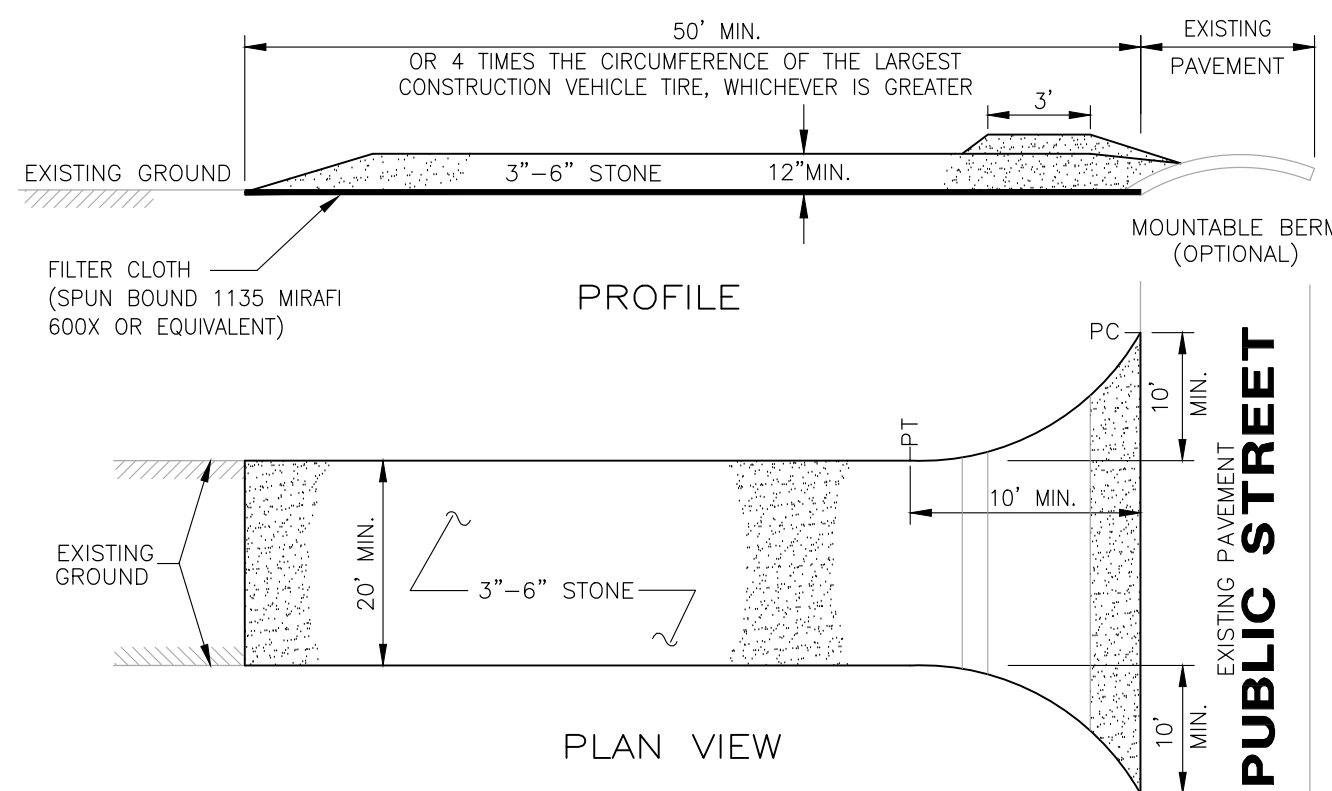

NOTES

1. FILTER CLOTH - WILL BE PLACED OVER THE ENTIRE AREA PRIOR TO PLACING OF STONE SURFACE.
2. WATER - ALL SURFACE WATER FLOWING OR DIVERTED TOWARD CONSTRUCTION ENTRANCES SHALL BE PIPED ACROSS THE ENTRANCE. IF PIPING IS IMPRACTICAL, A MOUNTABLE BERM WITH 5:1 SLOPES WILL BE PERMITTED.
3. MAINTENANCE - THE ENTRANCE SHALL BE MAINTAINED IN A CONDITION WHICH WILL PREVENT TRACKING OR FLOWING OF SEDIMENT ONTO PUBLIC RIGHTS-OF-WAY. THIS MAY REQUIRE PERIODIC TOP DRESSING WITH ADDITIONAL STONE AS CONDITIONS DEMAND AND REPAIR AND/OR CLEANOUT OF ANY MEASURES USED TO TRAP SEDIMENT. ALL SEDIMENT SPILLED, DROPPED, WASHED OR TRACKED ONTO PUBLIC RIGHTS-OF-WAY MUST BE REMOVED IMMEDIATELY.
4. WASHING - WHEELS SHALL BE CLEANED TO REMOVE SEDIMENT PRIOR TO ENTRANCE ONTO PUBLIC RIGHTS-OF-WAY. WHEN WASHING IS REQUIRED, IT SHALL BE DONE ON AN AREA STABILIZED WITH STONE AND WHICH DRAINS INTO AN APPROVED SEDIMENT TRAPPING DEVICE.
5. PERIODIC INSPECTION AND NEEDED MAINTENANCE SHALL BE PROVIDED AFTER EACH RAIN STORM EVENT.

STABILIZED CONSTRUCTION ENTRANCE
NOT TO SCALE

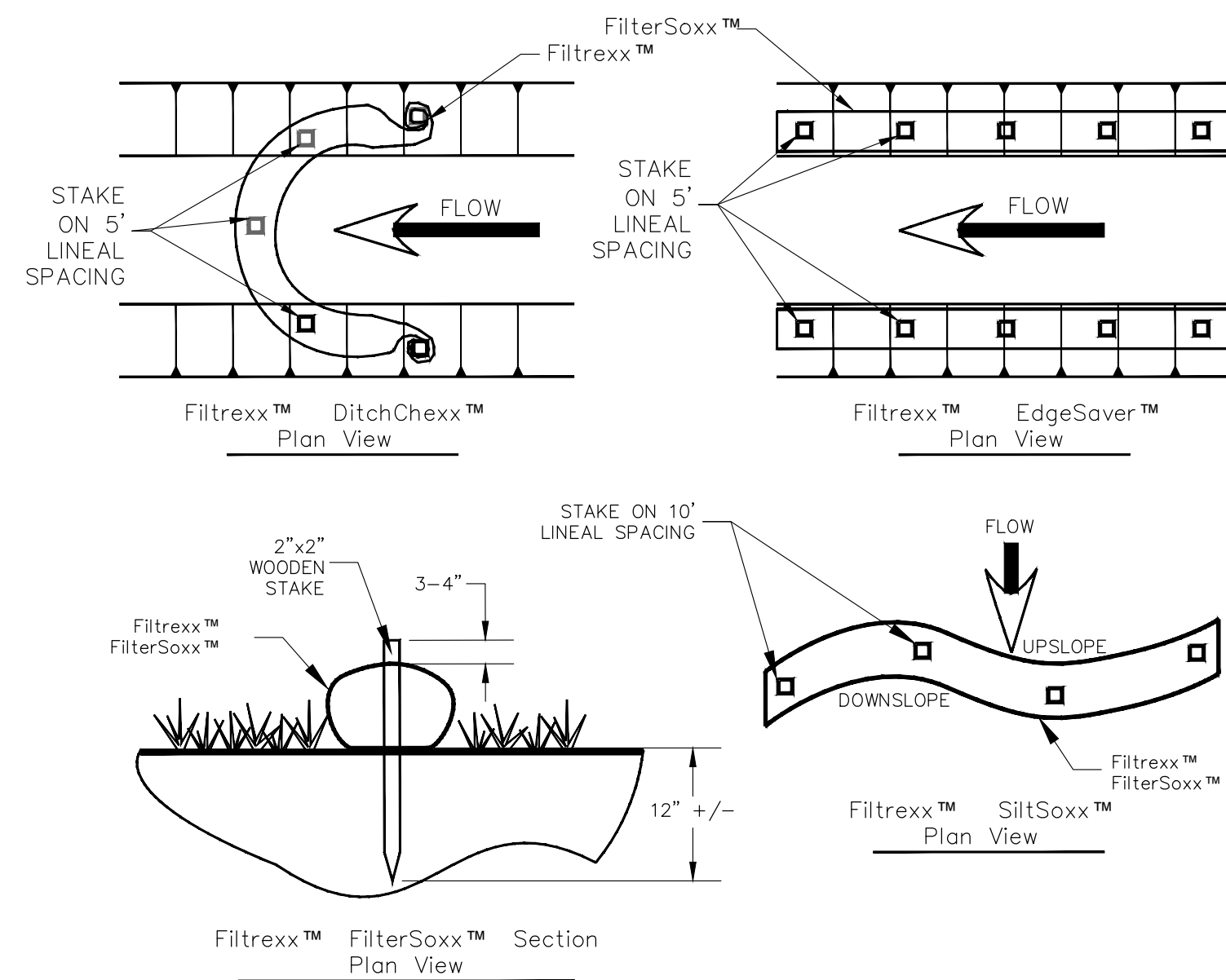

NOTES:

1. ALL MATERIAL TO MEET Filtrex™ SPECIFICATIONS
2. FilterSoxx™ COMPOST/SOIL/ROCK/SEED FILL TO MEET APPLICATION REQUIREMENTS.
3. COMPOST MATERIAL TO BE DISPERSED ON SITE, AS DETERMINED BY ENGINEER.
4. SIZE OF SOCK TO BE PER MANUFACTURER'S SPECIFICATIONS

FILTREXX™ FILTERSOXX™ STAKING
NOT TO SCALE

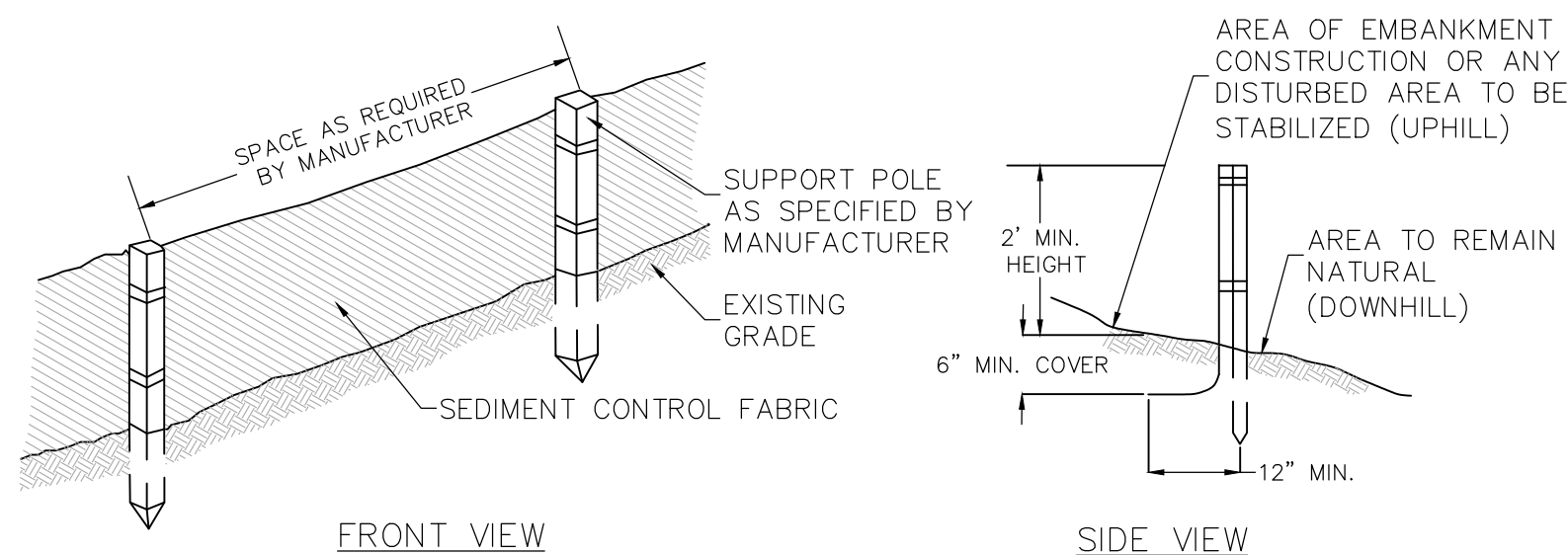

NOTES

1. THE GEOTEXTILE FABRIC SHALL MEET THE DESIGN CRITERIA FOR BEST MANAGEMENT PRACTICE FOR SILT FENCES, OF THE NEW HAMPSHIRE STORMWATER MANUAL, DECEMBER 2008.
2. THE HEIGHT OF THE BARRIER SHALL NOT EXCEED 36 INCHES.
3. WHEN JOINTS ARE NECESSARY, FILTER CLOTH SHALL BE SPLICED TOGETHER ONLY AT A SUPPORT POST, WITH A MINIMUM 6-INCH OVERLAP, AND SECURELY SEALED. SEE MANUFACTURER'S RECOMMENDATIONS.
4. POSTS SHALL BE SPACED A MAXIMUM OF 10 FEET APART AT THE BARRIER LOCATION AND DRIVEN SECURELY INTO THE GROUND (MINIMUM OF 16 INCHES). WHEN EXTRA STRENGTH FABRIC IS USED WITHOUT THE WIRE SUPPORT FENCE, POST SPACING SHALL BE AS MANUFACTURER RECOMMENDS.
5. A TRENCH SHALL BE EXCAVATED APPROXIMATELY 6 INCHES WIDE AND 6 INCHES DEEP ALONG THE LINE OF POSTS AND UPSLOPE FROM THE BARRIER IN ACCORDANCE WITH RECOMMENDATIONS.
6. THE FABRIC SHALL NOT EXTEND MORE THAN 36 INCHES ABOVE THE ORIGINAL GROUND SURFACE, AND WILL EXTEND TO A MINIMUM OF 8 INCHES INTO THE TRENCH. FILTER FABRIC SHALL NOT BE STAPLED INTO EXISTING TREES.
7. THE TRENCH SHALL BE BACKFILLED AND THE SOIL COMPACTED OVER THE FILTER FABRIC.
8. FILTER BARRIERS SHALL BE REMOVED WHEN THEY HAVE SERVED THEIR USEFUL PURPOSE, BUT NOT BEFORE THE UPSLOPE AREA HAS BEEN PERMANENTLY STABILIZED.
9. FILTER BARRIERS SHALL BE INSPECTED IMMEDIATELY AFTER EACH RAINFALL, AND AT LEAST DAILY DURING PROLONGED RAINFALL, ANY REQUIRED REPAIRS SHALL BE MADE IMMEDIATELY.
10. SHOULD THE FABRIC DECOMPOSE OR BECOME INEFFECTIVE PRIOR TO THE END OF THE EXPECTED USABLE LIFE AND THE BARRIER STILL BE NECESSARY, THE FABRIC SHALL BE REPLACED PROMPTLY.
11. SEDIMENT DEPOSITS SHOULD BE REMOVED WHEN THEY REACH APPROXIMATELY ONE-THIRD THE HEIGHT OF THE BARRIER.
12. ANY SEDIMENT DEPOSITS REMAINING IN PLACE AFTER THE SILT FENCE OR FILTER BARRIER IS NO LONGER REQUIRED, SHALL BE DRESSED TO CONFORM TO THE EXISTING GRADE, PREPARED AND SEEDED.

SILT FENCE
NOT TO SCALE

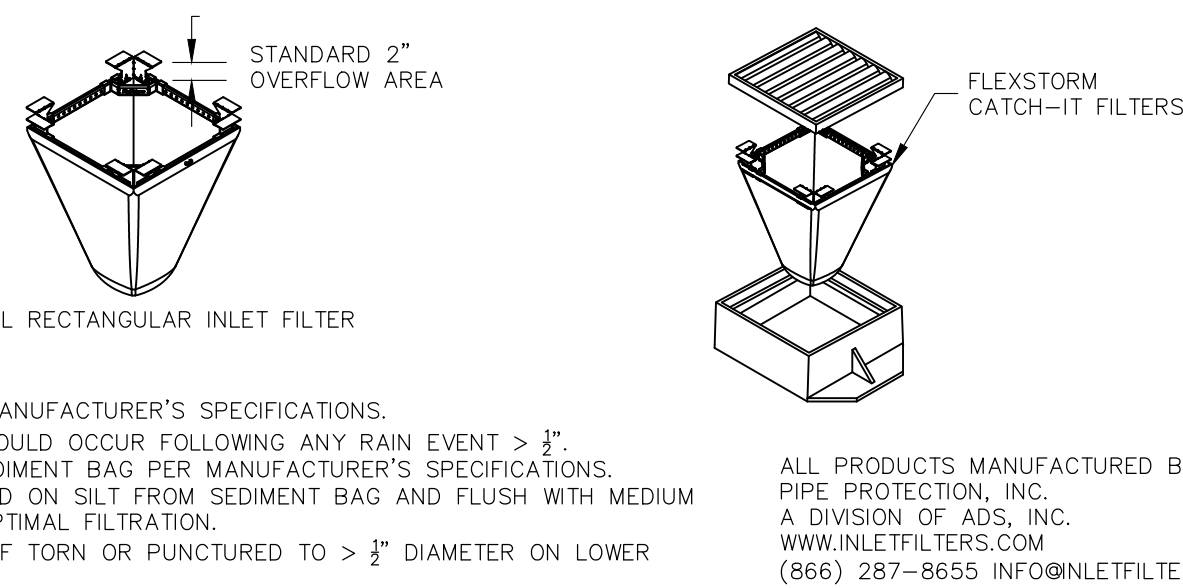

NOTES:

1. INSTALL PER MANUFACTURER'S SPECIFICATIONS.
2. INSPECTION SHOULD OCCUR FOLLOWING ANY RAIN EVENT > 1/4\"/>

ALL PRODUCTS MANUFACTURED BY INLET & PIPE PROTECTION, INC. A DIVISION OF ADS, INC. WWW.INLETFILTERS.COM (866) 287-8655 INFO@INLETFILTERS.COM

INLET PROTECTION
NOT TO SCALE

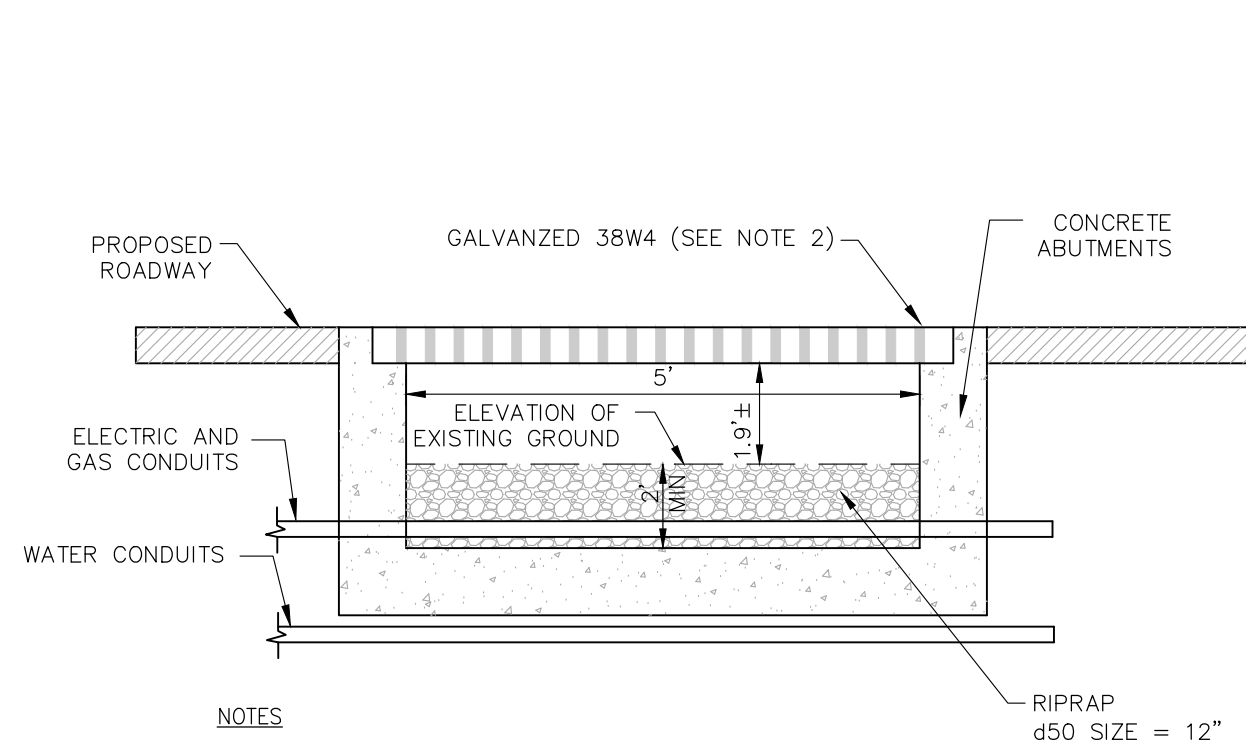

NOTES

1. CONCRETE SHALL BE 5000 PSI.
2. GRATING TO BE EQUIVALENT TO 38W4 (4-1/2\"/>

ECO PASSAGE #1 DETAIL
NOT TO SCALE

% OF WEIGHT SMALLER FOR d50=12\"/>	
100	18.00 TO 24.00
85	15.60 TO 21.6
50	12.00 TO 18.00
15	3.60 TO 6.00

MAINTENANCE:

THE OUTLET PROTECTION SHOULD BE CHECKED AT LEAST ANNUALLY AND AFTER EVERY MAJOR STORM. IF THE RIP RAP HAS BEEN DISPLACED, UNDERMINED OR DAMAGED, IT SHOULD BE CHECKED TO SEE THAT EROSION IS NOT OCCURRING. THE DOWNSTREAM CHANNEL SHOULD BE KEPT CLEAR OF OBSTRUCTIONS SUCH AS FALLEN TREES, DEBRIS, AND SEDIMENT THAT COULD CHANGE FLOW PATTERNS AND/OR TAILWATER DEPTHS ON THE PIPES. REPAIRS MUST BE CARRIED OUT IMMEDIATELY TO AVOID ADDITIONAL DAMAGE TO THE OUTLET PROTECTION APRON.

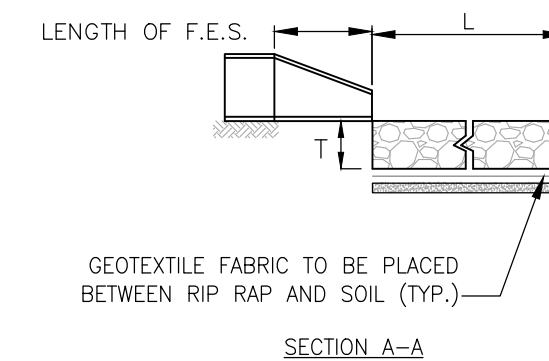

CONSTRUCTION SPECIFICATIONS:

1. THE SUBGRADE FOR THE FILTER MATERIAL, GEOTEXTILE FABRIC, AND RIP RAP SHALL BE PREPARED TO THE LINES AND GRADES SHOWN ON THE PLANS.
2. THE ROCK OR GRAVEL USED FOR FILTER OR RIP RAP SHALL CONFORM TO THE SPECIFIED GRADATION.
3. GEOTEXTILE FABRICS SHALL BE PROTECTED FROM PUNCTURE OR TEARING DURING THE PLACEMENT OF THE ROCK RIP RAP. DAMAGED AREAS IN THE FABRIC SHALL BE REPAIRED BY PLACING A PIECE OF FABRIC OVER THE DAMAGED AREA OR BY COMPLETE REPLACEMENT OF THE FABRIC. ALL OVERLAPS REQUIRED FOR REPAIRS OR JOINING TWO PIECES OF FABRIC SHALL BE A MINIMUM OF 12\"/>

% OF WEIGHT SMALLER FOR d50=3\"/>	
100	4.50 TO 6.00
85	3.90 TO 5.40
50	3.00 TO 4.50
15	0.90 TO 1.50

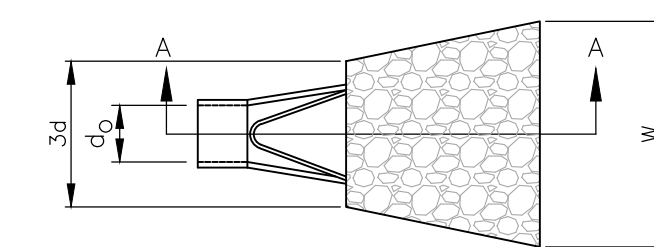

RIP RAP AND FLARED END SECTION WITH OUTLET PROTECTION
NOT TO SCALE

RIPRAP DIMENSIONS

LOCATION	FES01	FES02	FES03	FES04	FES05	FES06	FES07	FES08	FES09	FES10	FES11
d50 STONE SIZE (IN)	3	3	3	3	3	3	3	3	3	3	3
L-LENGTH OF APRON (FT)	7	8	15	12	7	9	9	19	14	9	9
W-WIDTH OF APRON (FT)	6	6	9	8	6	7	7	11	8	5	5
T-DEPTH OF APRON (IN)	7	7	7	7	7	7	7	7	7	7	7

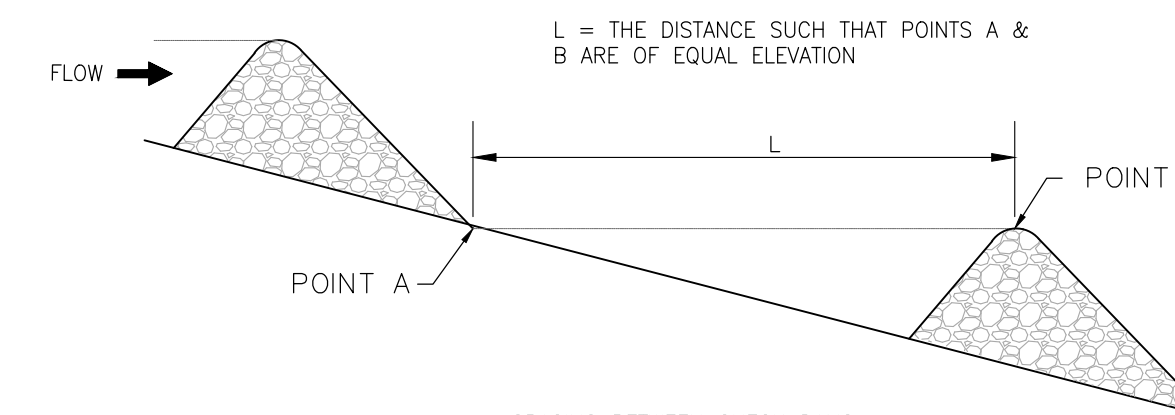

SPACING BETWEEN CHECK DAMS

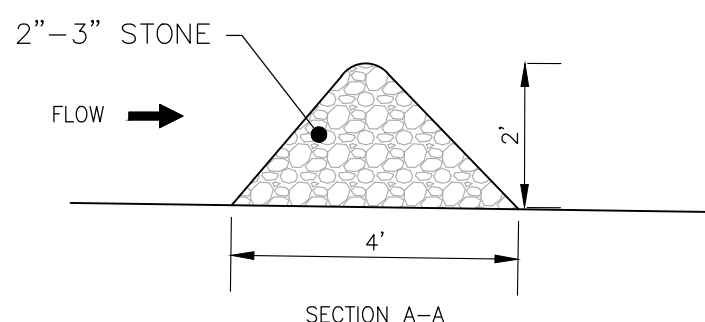
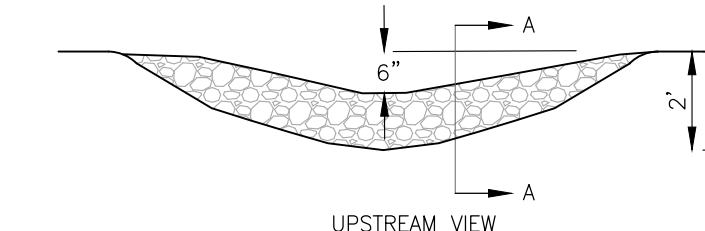

STONE CHECK DAM
NOT TO SCALE

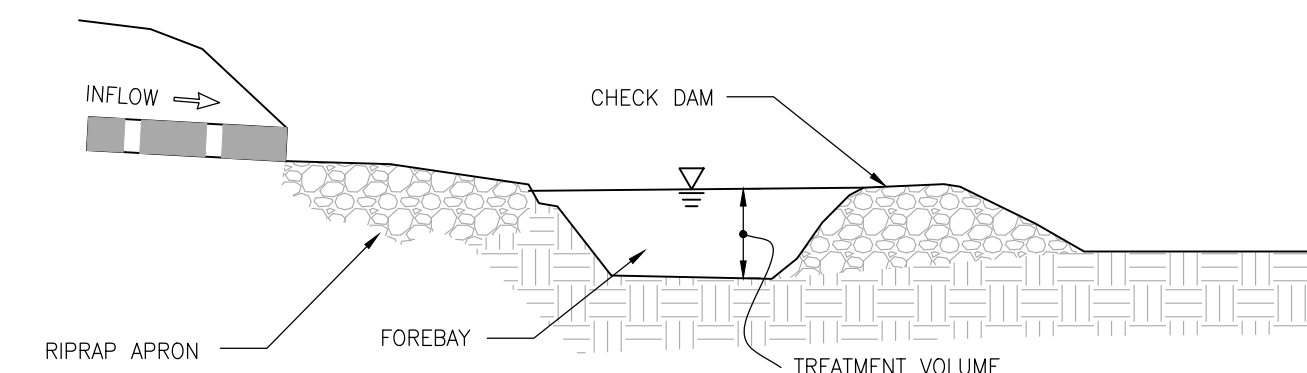

SEDIMENT FOREBAY DETAIL
NOT TO SCALE

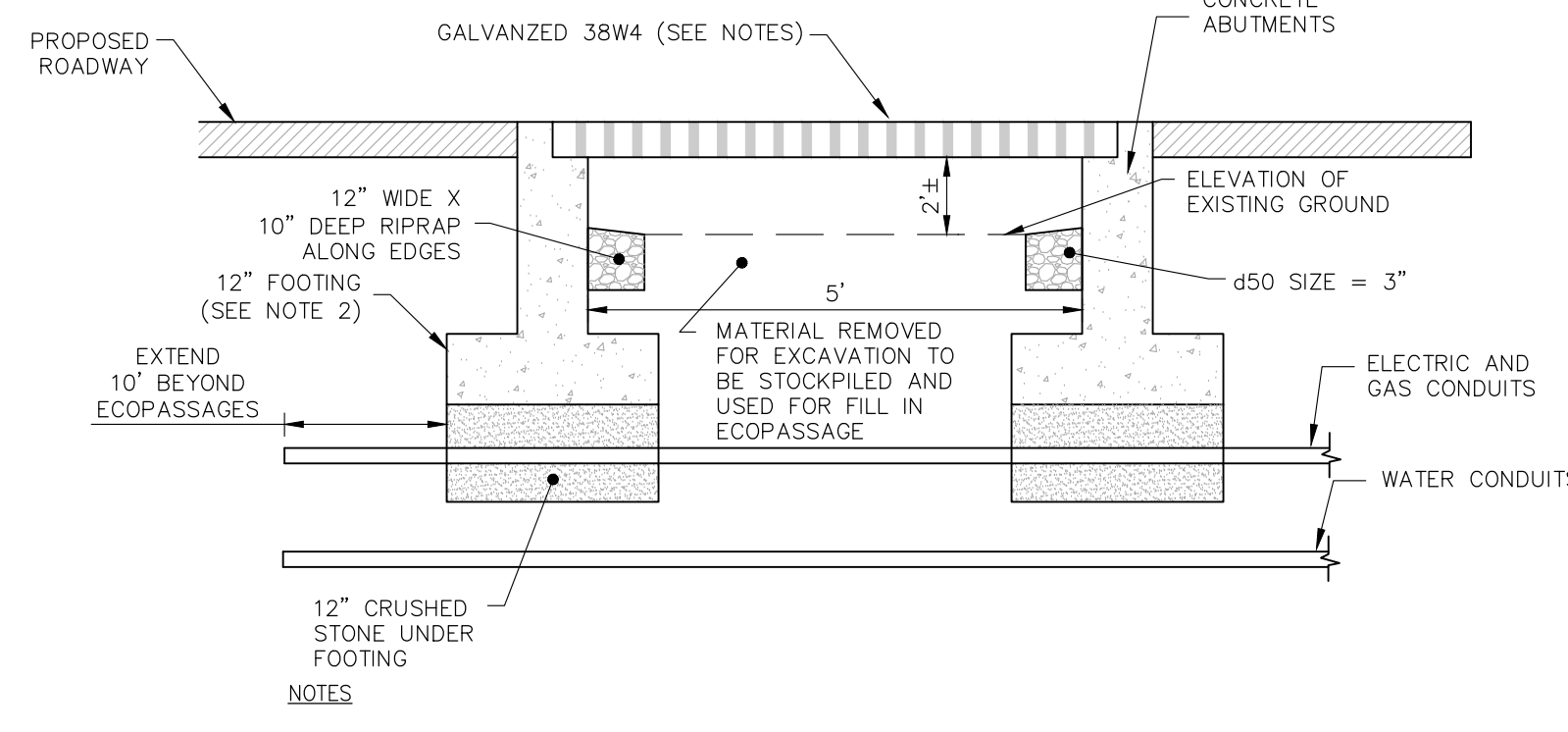

NOTES

1. SEE ECO PASSAGE #1 DETAIL FOR NOTES.

ECO PASSAGE #2 AND #3 DETAIL
NOT TO SCALE

% OF WEIGHT SMALLER FOR d50=3\"/>	
100	4.50 TO 6.00
85	3.90 TO 5.40
50	3.00 TO 4.50
15	0.90 TO 1.50

REV	DATE	DESCRIPTION	DR	CK
6	5/5/2020	AoT SUBMITTAL	RCK	JJM
5	4/29/2020	REVISOR PER REGULATORY COMMENTS	RCK	JJM
4	3/20/2020	PROGRESS PRINT	RCK	JJM
3	3/4/2020	UPDATE PLANS PER REGULATORY COMMENTS	RCK	JJM
2	12/27/2019	IN HOUSE REVISIONS	RCK	JJM
1	12/23/19	NO REVISIONS THIS SHEET	RCK	JJM

SITE DEVELOPMENT PLANS

TAX MAP 256 LOT 2
DETAILS
THE VILLAGE AT BANFIELD WOODS
PORTSMOUTH, NH
OWNED BY
WALTER D HETT TRUST
PREPARED FOR
GREEN & COMPANY REAL ESTATE

SCALE: NTS

SEPTEMBER 25, 2019

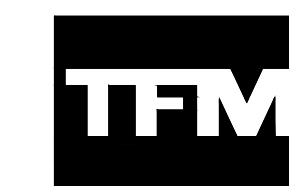

Civil Engineers
Structural Engineers
Traffic Engineers
Land Surveyors
Landscape Architects
Scientists

48 Constitution Drive
Bedford, NH 03110
Phone (603) 472-4488
Fax (603) 472-9747
www.tfmoran.com

47361.00	DR RCK	FB	-	
	CK JJM	CADFILE	DETAILS	C-32

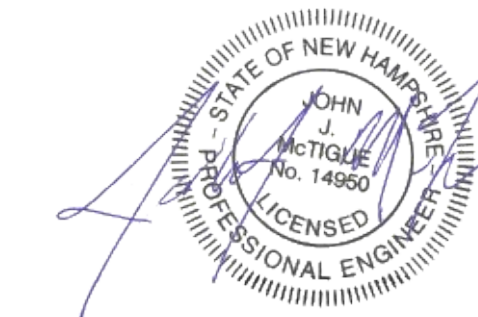

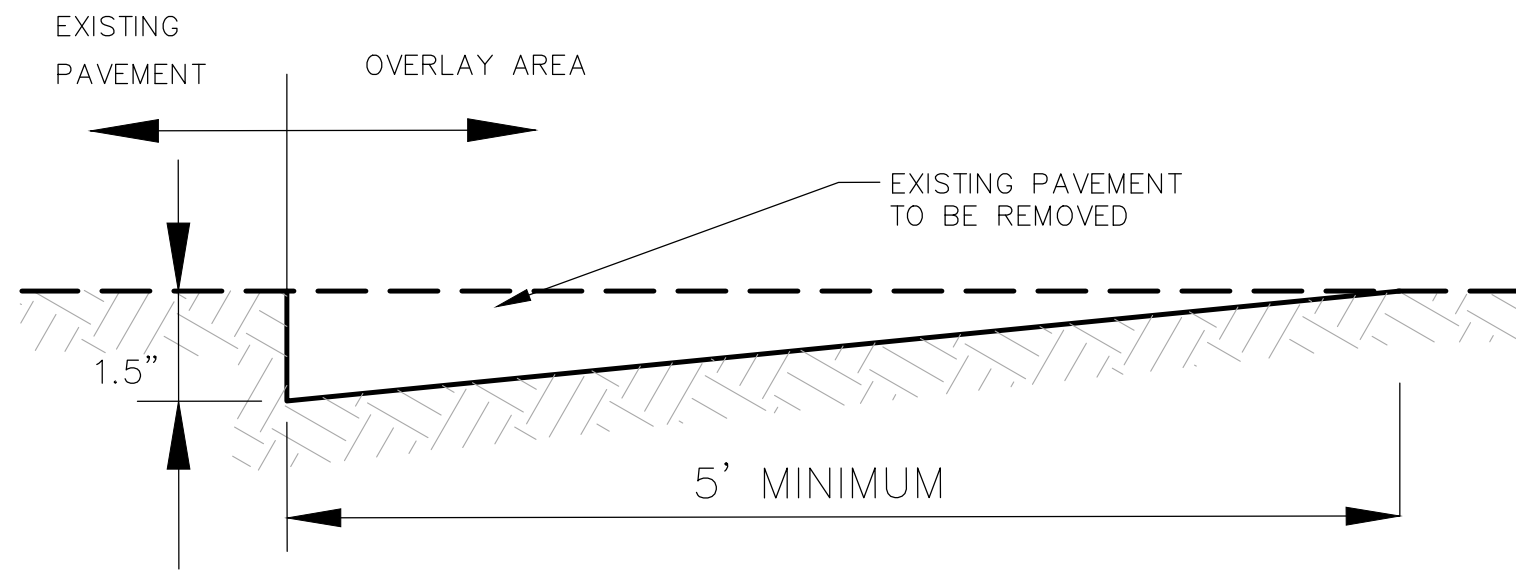

- NOTES:**
1. USE KEY JOINT AT ALL LOCATIONS WHERE OVERLAY MEETS EXISTING PAVEMENT.
 2. NEW PAVEMENT SHALL BE FLUSH WITH EXISTING PAVEMENT AND SHALL MEET OVERLAY GRADE WHERE IT ABUTS EXISTING PAVEMENT TO BE OVERLAPPED.

KEY JOINT DETAIL
NOT TO SCALE

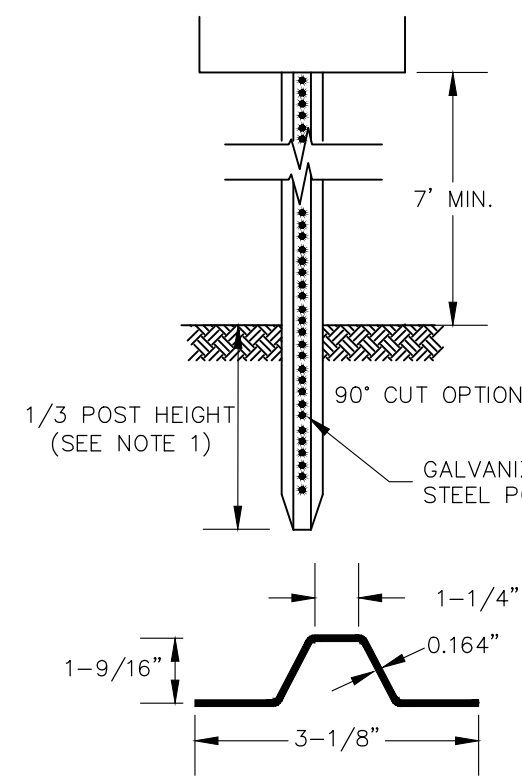

LENGTH: AS REQUIRED
 WEIGHT PER LINEAR FOOT: 2.50 LBS (MIN)
 HOLES: 3/8" DIAMETER, 1" C-C FULL LENGTH
 STEEL: SHALL CONFORM TO ASTM A-499 (GRADE 60) OR ASTM A-576 (GRADE 1070 - 1080)
 FINISH: SHALL BE PAINTED WITH 2 COATS OF AN APPROVED MEDIUM GREEN BAKED-ON OR AIR-DRIED PAINT OF WEATHER RESISTANT QUALITY. ALL FABRICATION SHALL BE COMPLETE BEFORE PAINTING.

- NOTE:**
1. WHERE LEDGE APPLICATION EXISTS, DRILL & GROUT TO A MINIMUM OF 2"
 2. ALL SIGNAGE SHALL FOLLOW THE MANUAL OF UNIFORM TRAFFIC CONTROL DEVICES STANDARDS AND NHDOT STANDARDS.
 3. SIGN, HARDWARE, AND INSTALLATION SHALL CONFORM TO THE LATEST NHDOT STANDARD SPECIFICATIONS.

SIGN POST
NOT TO SCALE



D3-1
 X" x X"
 WHITE LETTERS W/
 GREEN BACKGROUND

- NOTES**
1. SIGN SHALL MEET MUTCD AND THE CITY OF PORTSMOUTH DEPARTMENT OF PUBLIC WORKS STANDARDS.

STREET SIGN
NOT TO SCALE

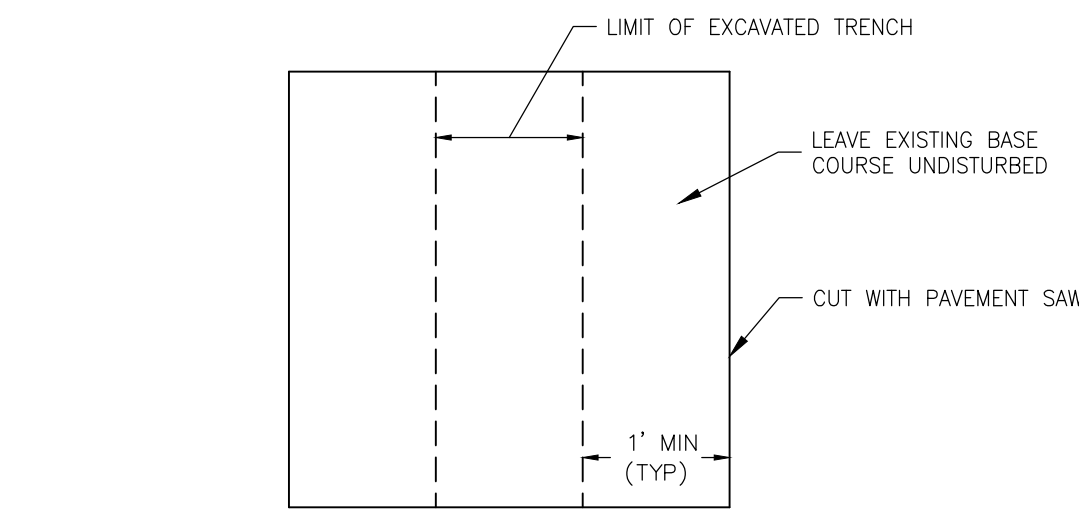

IN AREAS WHERE OVERLAY IS PROPOSED, FULL-DEPTH PAVEMENT REPAIR SHALL BE IN PLACE PRIOR TO INSTALLATION OF FINAL OVERLAY COURSE

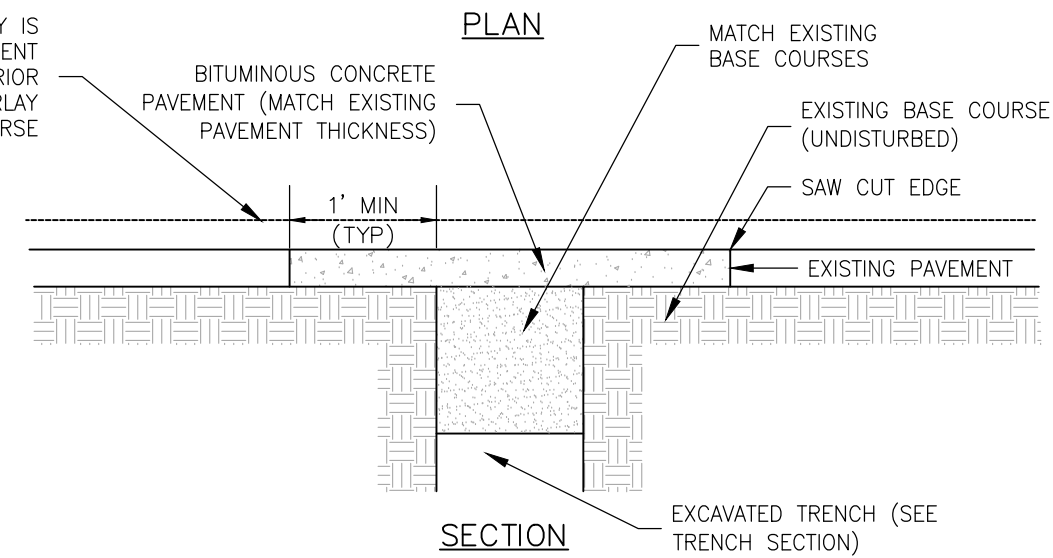

TRENCH PATCH
NOT TO SCALE

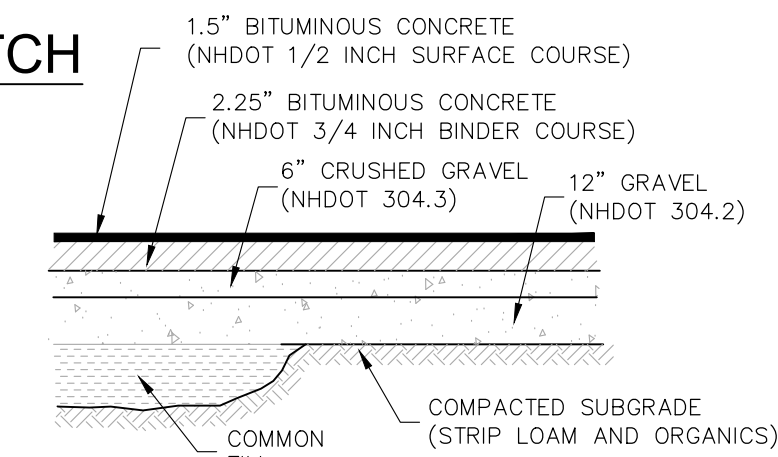

STANDARD DUTY PAVEMENT

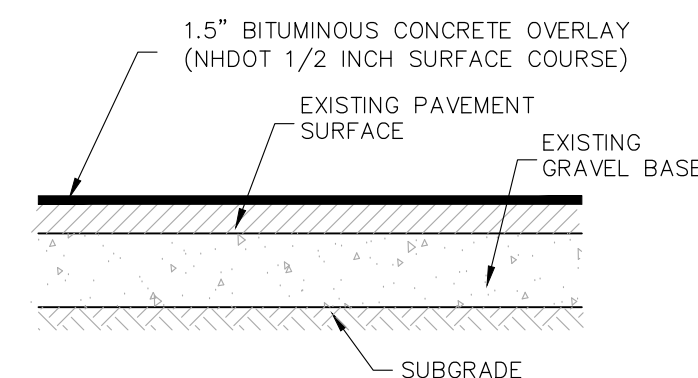

OVERLAY

- NOTES**
1. SEE GRADING & EROSION CONTROL PLAN FOR PAVEMENT SLOPE AND CROSS-SLOPE.
 2. PROVIDE CLEAN BUTT TO EXISTING PAVEMENT- USE TACK COAT. A TACK COAT SHALL ALSO BE PLACED BETWEEN GRAVEL COURSE AND SUCCESSIVE LAYERS OF BITUMINOUS CONCRETE. SPECIFICALLY, A TACK COAT SHALL BE PLACED ATOP THE BINDER COURSE PAVEMENT PRIOR TO PLACING THE WEARING COURSE.
 3. REMOVE ALL LOAM AND/OR YIELDING MATERIAL BELOW PAVEMENT.
 4. BITUMINOUS MATERIALS SHALL CONFORM TO NHDOT SPECIFICATION SECTION 401.
 5. BITUMINOUS CONCRETE SHALL BE COMPACTED TO AT LEAST 92.5% OF THEORETICAL MAXIMUM DENSITY AS DETERMINED BY ASTM D2041 OR AASHTO T209. PLACEMENT TEMPERATURES OF BITUMINOUS CONCRETE MIXES, IN GENERAL, RANGE BETWEEN 270 AND 310 DEGREES FAHRENHEIT.
 6. PAVEMENT BASE COURSE AGGREGATE SHALL CONFORM TO NHDOT SPECIFICATION SECTION 304, ITEM 304.3 AND COMPACTED TO A MINIMUM OF 95% OF MODIFIED PROCTOR MAXIMUM DRY DENSITY.
 7. PAVEMENT SUBBASE COURSE AGGREGATE AND AGGREGATE FOR SUBGRADE REPAIR AREAS SHALL BE SUITABLE FOR USE AS STRUCTURAL FILL AND BE PROOF ROLLED AND COMPACTED TO 95% MODIFIED PROCTOR MAXIMUM DRY DENSITY.
 8. THE EXPOSED SOIL SUBGRADE SHOULD BE PROOF ROLLED PRIOR TO THE PLACEMENT OF SUBBASE GRAVEL, AND SOFT AREAS SHOULD BE REPAIRED AND REPLACED.
 9. ALL PARKING SPACES SHALL BE STANDARD DUTY. ALL OTHER LOCATIONS SHALL BE HEAVY DUTY.

PAVEMENT SECTIONS
NOT TO SCALE

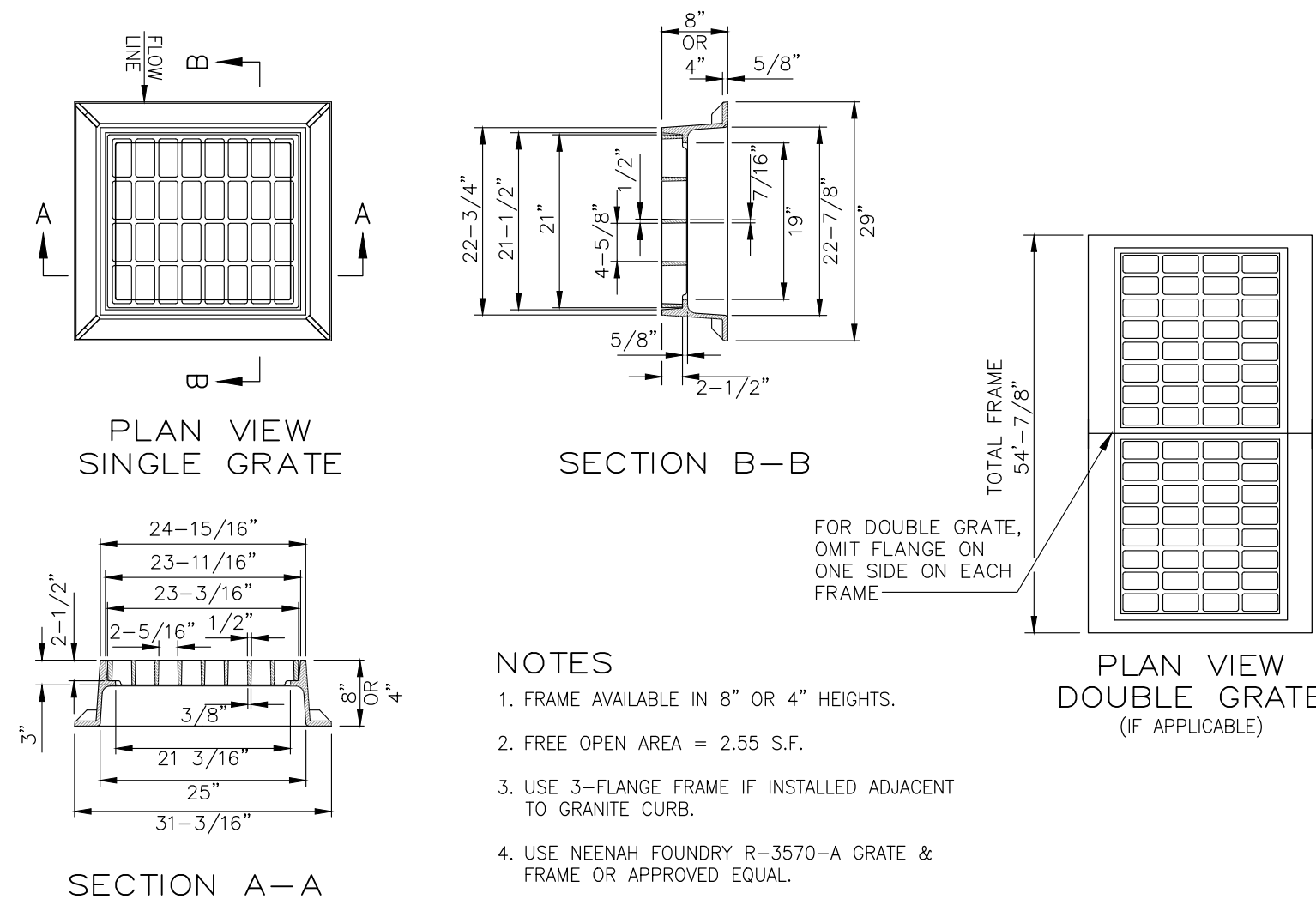

FRAME & GRATE (TYPE B)
NOT TO SCALE

- NOTES**
1. FRAME AVAILABLE IN 8" OR 4" HEIGHTS.
 2. FREE OPEN AREA = 2.55 S.F.
 3. USE 3-FLANGE FRAME IF INSTALLED ADJACENT TO GRANITE CURB.
 4. USE NEENAH FOUNDRY R-3570-A GRATE & FRAME OR APPROVED EQUAL.

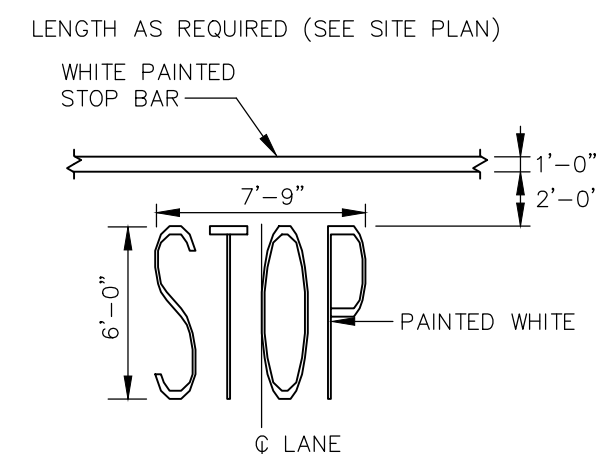

- NOTES**
1. TRAFFIC PAINT SHALL BE APPLIED AS SPECIFIED BY THE MANUFACTURER AND SHALL MEET THE REQUIREMENTS OF AASHTO M248 TYPE "F". APPLY TWO COATS.
 2. SYMBOLS AND PARKING STALLS SHALL CONFORM TO THE REQUIREMENTS OF THE AMERICANS WITH DISABILITIES ACT, LATEST EDITION.

STOP BAR & LEGEND
NOT TO SCALE

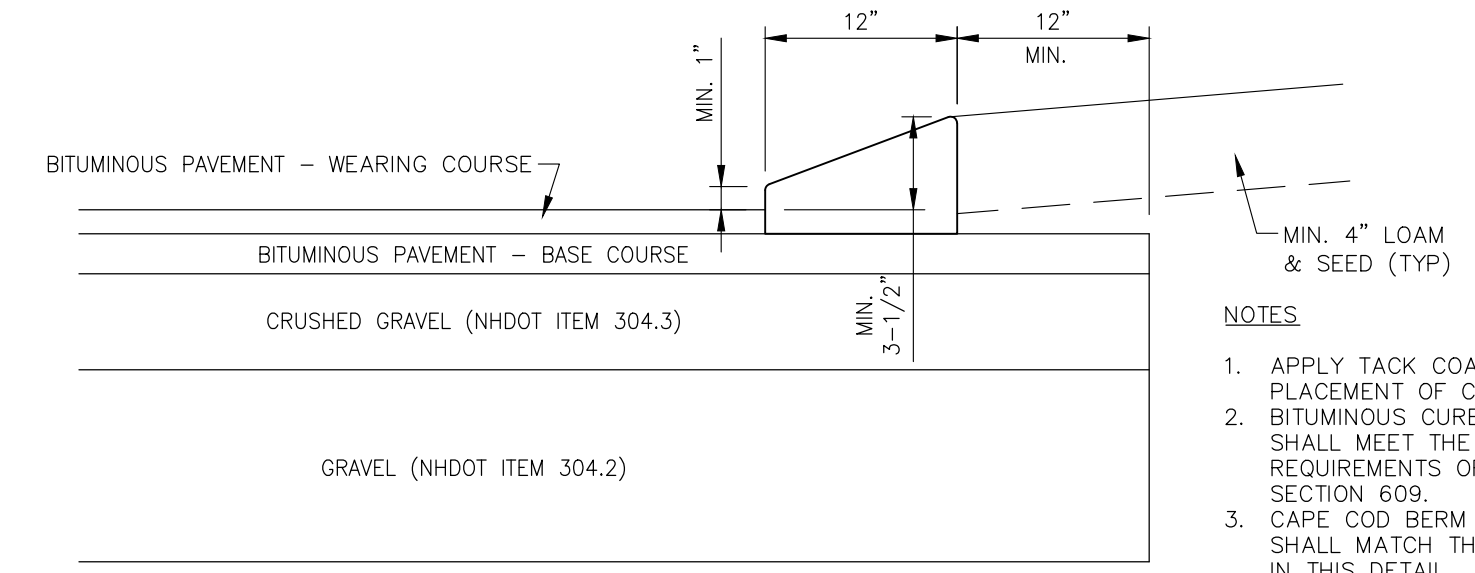

CAPE COD BERM
NOT TO SCALE

- NOTES**
1. APPLY TACK COAT PRIOR TO PLACEMENT OF CURB.
 2. BITUMINOUS CURB MATERIAL SHALL MEET THE REQUIREMENTS OF NHDOT SECTION 609.
 3. CAPE COD BERM DIMENSIONS SHALL MATCH THOSE GIVEN IN THIS DETAIL.

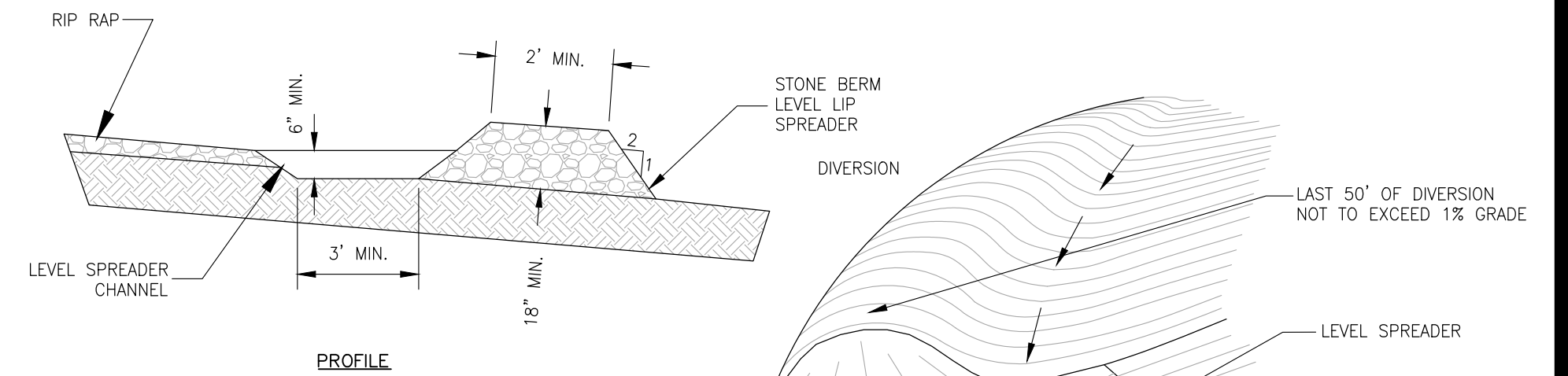

STONE GRADATION*

% PASSING # SIEVE (SIZE)	
100%	12-INCH SIEVE
84 - 100%	6-INCH SIEVE
68 - 83%	3-INCH SIEVE
42 - 55%	1-INCH SIEVE
8 - 12%	#4 SIEVE

*PER NHDES ENV-WQ 1508.18

CONSTRUCTION SPECIFICATIONS

1. CONSTRUCT THE LEVEL SPREADER LIP ON A ZERO PERCENT GRADE TO INSURE UNIFORM SPREADING OF RUNOFF.
2. LEVEL SPREADER SHALL BE STABILIZED PRIOR TO ACCEPTING RUNOFF.
3. AN EROSION STOP SHALL BE PLACED VERTICALLY A MINIMUM OF SIX INCHES DEEP IN A SILT TRENCH ONE FOOT BACK OF THE LEVEL LIP AND PARALLEL TO THE LIP. EROSION STOP SHALL EXTEND THE ENTIRE LENGTH OF THE LEVEL LIP.
4. THE ENTIRE LEVEL LIP AREA SHALL BE PROTECTED BY PLACING TWO STRIPS OF JUTE OR EXCELSIOR MATTING ALONG THE LIP. EACH STRIP SHALL OVERLAP THE EROSION STOP AT LEAST SIX INCHES.
5. THE ENTRANCE CHANNEL TO THE LEVEL SPREADER SHALL NOT EXCEED ONE PERCENT GRADE FOR AT LEAST FIFTY FEET BEFORE ENTERING INTO THE SPREADER.
6. THE FLOW FROM THE LEVEL SPREADER SHALL OUTLET ONTO STABILIZED AREAS. WATER SHOULD NOT RECONCENTRATE IMMEDIATELY BELOW THE SPREADER.
7. PERIODIC INSPECTION AND REQUIRED MAINTENANCE SHALL BE PERFORMED.

LEVEL SPREADER
NOT TO SCALE

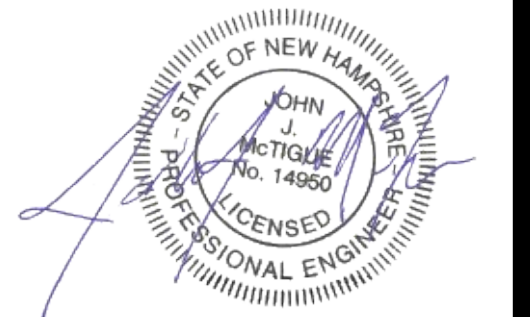

SITE DEVELOPMENT PLANS

TAX MAP 256 LOT 2
DETAILS
THE VILLAGE AT BANFIELD WOODS
PORTSMOUTH, NH
 OWNED BY
WALTER D HETT TRUST
 PREPARED FOR
GREEN & COMPANY REAL ESTATE

SCALE: NTS

SEPTEMBER 25, 2019



Civil Engineers
 Structural Engineers
 Traffic Engineers
 Land Surveyors
 Landscape Architects
 Scientists

48 Constitution Drive
 Bedford, NH 03110
 Phone (603) 472-4488
 Fax (603) 472-9747
 www.tfmoran.com

REV	DATE	DESCRIPTION	DR	CK
6	5/5/2020	AoT SUBMITTAL	RCK	JJM
5	4/29/2020	REVISOR PER REGULATORY COMMENTS	RCK	JJM
4	3/20/2020	PROGRESS PRINT	RCK	JJM
3	3/4/2020	UPDATE PLANS PER REGULATORY COMMENTS	RCK	JJM
2	12/27/2019	IN HOUSE REVISIONS	RCK	JJM
1	12/23/19	NO REVISIONS THIS SHEET	RCK	JJM

47361.00 DR RCK FB
 CK JUM CADFILE
 DETAILS
 C-33



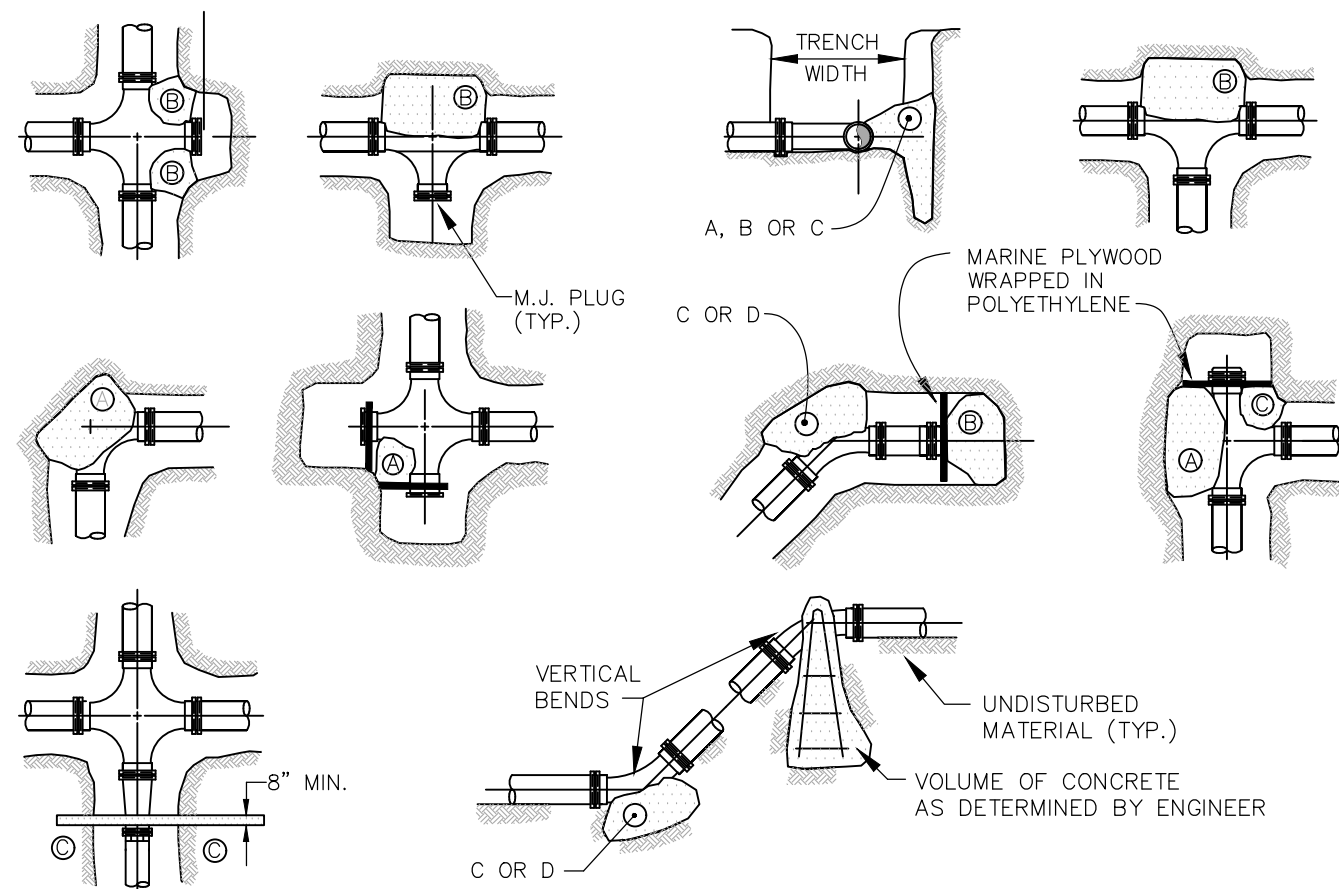

- NOTES:**
- POUR THRUST BLOCKS AGAINST UNDISTURBED MATERIAL, WHERE TRENCH WALL HAS BEEN DISTURBED. EXCAVATE LOOSE MATERIAL AND EXTEND THRUST BLOCK TO UNDISTURBED MATERIAL. NO PIPE JOINTS SHALL BE COVERED WITH CONCRETE.
 - ON BENDS AND TEES, EXTEND THRUST BLOCKS FULL LENGTH OF FITTING.
 - PLACE BOARD IN FRONT OF ALL PLUGS BEFORE POURING THRUST BLOCKS.
 - WHERE MECHANICAL JOINT PIPE IS USED, MECHANICAL JOINT PLUG WITH RETAINER GLAND MAY BE SUBSTITUTED FOR END BLOCKINGS.
 - INSTALLATION AND STANDARD DIMENSIONAL REQUIREMENTS SHALL BE IN ACCORDANCE WITH THE CITY/TOWN ESTABLISHED RULES AND PROCEDURES.

REACTION TYPE	PIPE SIZE			
	4"	6"	8"	10"
A 90°	0.89	2.19	3.82	11.14
B 180°	0.65	1.55	2.78	8.38
C 45°	0.48	1.19	2.12	6.02
D 22-1/2°	0.25	0.60	1.06	3.08
E 11-1/4°	0.13	0.30	0.54	1.54

THRUST BLOCKS
NOT TO SCALE

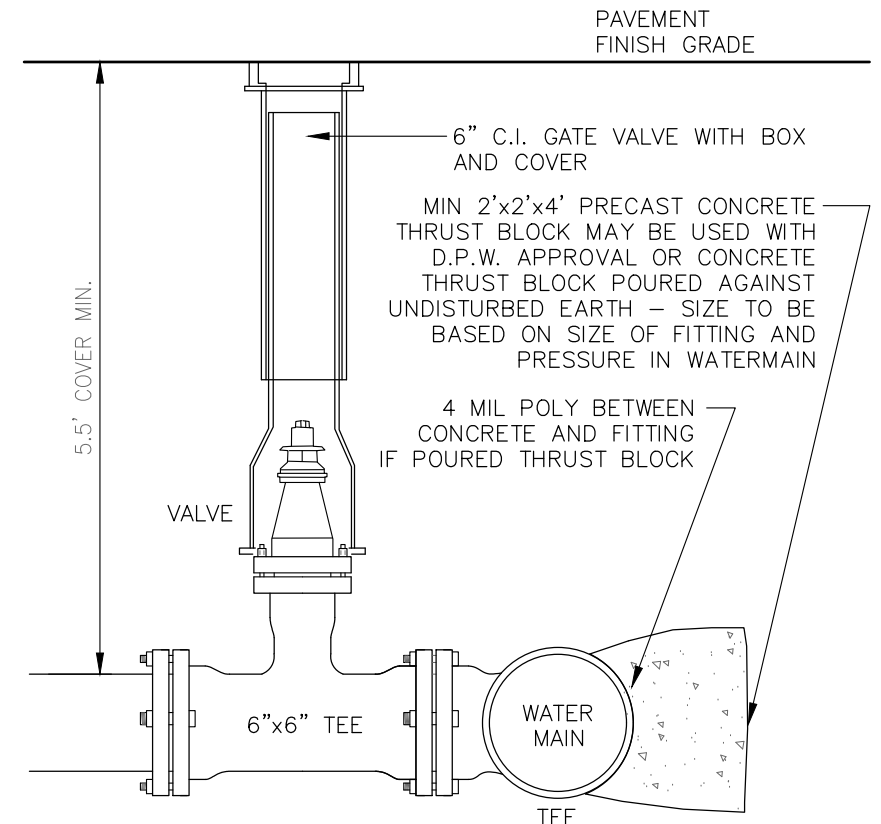

- NOTES:**
- VALVE TO OPEN RIGHT.

BURIED GATE VALVE
NOT TO SCALE

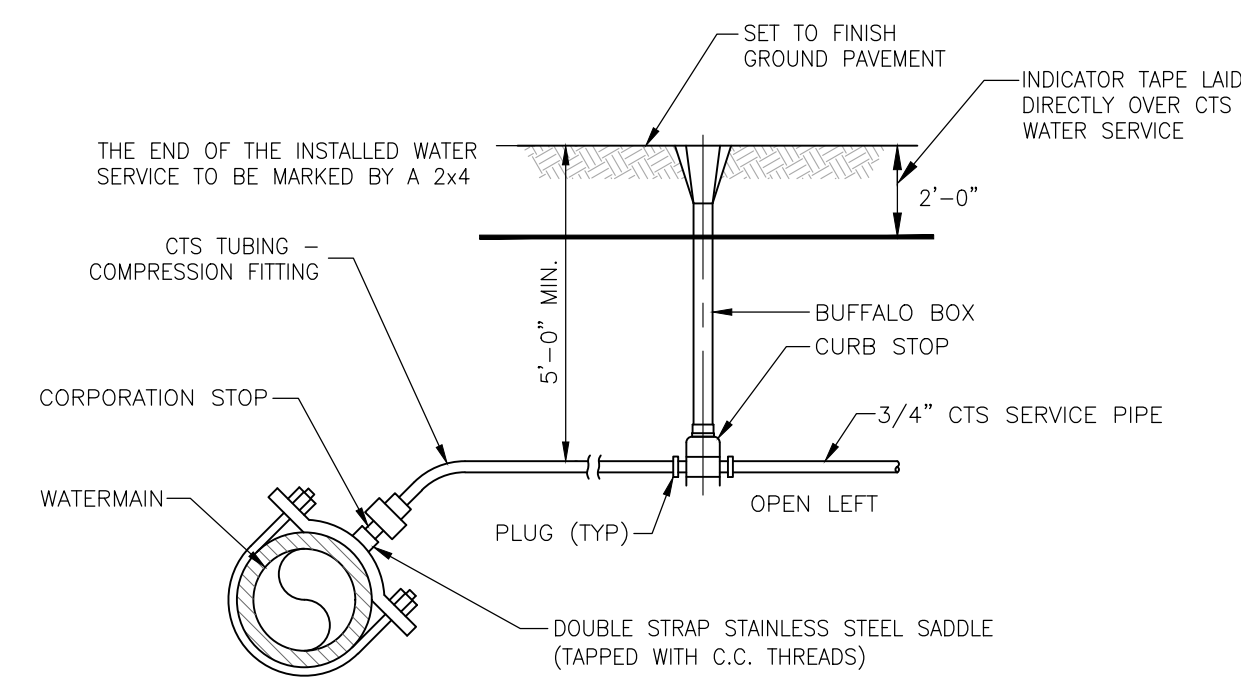

WATER SERVICE CONNECTION
NOT TO SCALE

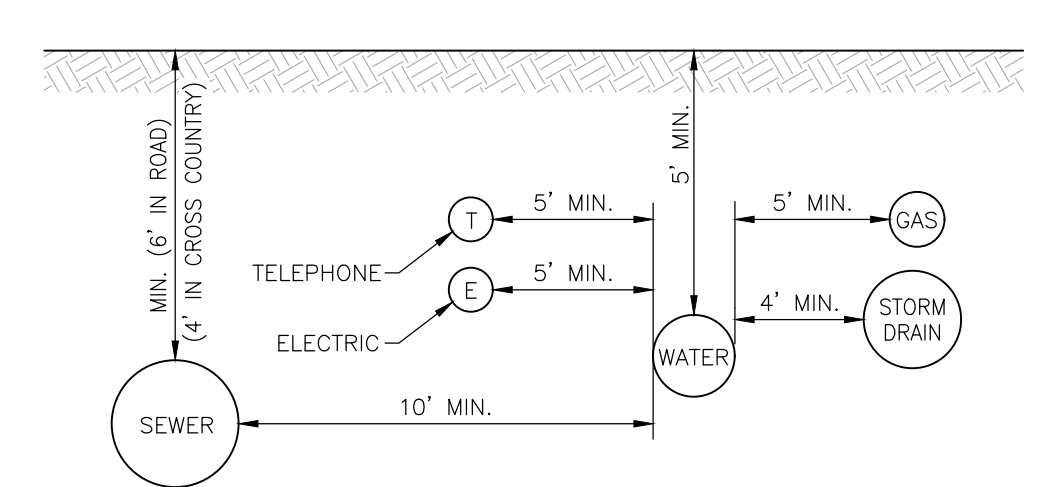

- NOTES:**
- ALL MATERIALS AND INSTALLATION PROCEDURES WILL CONFORM TO EXETER DPW TECHNICAL SPECIFICATIONS.
 - ALL WATER MAIN SHOULD HAVE A MINIMUM DEPTH OF 5' FROM TOP OF PIPE TO FINISH GRADE.
 - GAS MAIN SHALL HAVE A TYPICAL DEPTH OF 3' FROM THE TOP OF PIPE TO FINISH GRADE.
 - DETAIL REPRESENTS LATERAL SEPARATION ONLY UNLESS OTHERWISE NOTED. CONTRACTOR SHALL COORDINATE WITH APPROPRIATE UTILITY COMPANY FOR DEPTHS FOR GAS, TELEPHONE, AND ELECTRIC.

TYPICAL UTILITY LATERAL SEPARATION
NOT TO SCALE

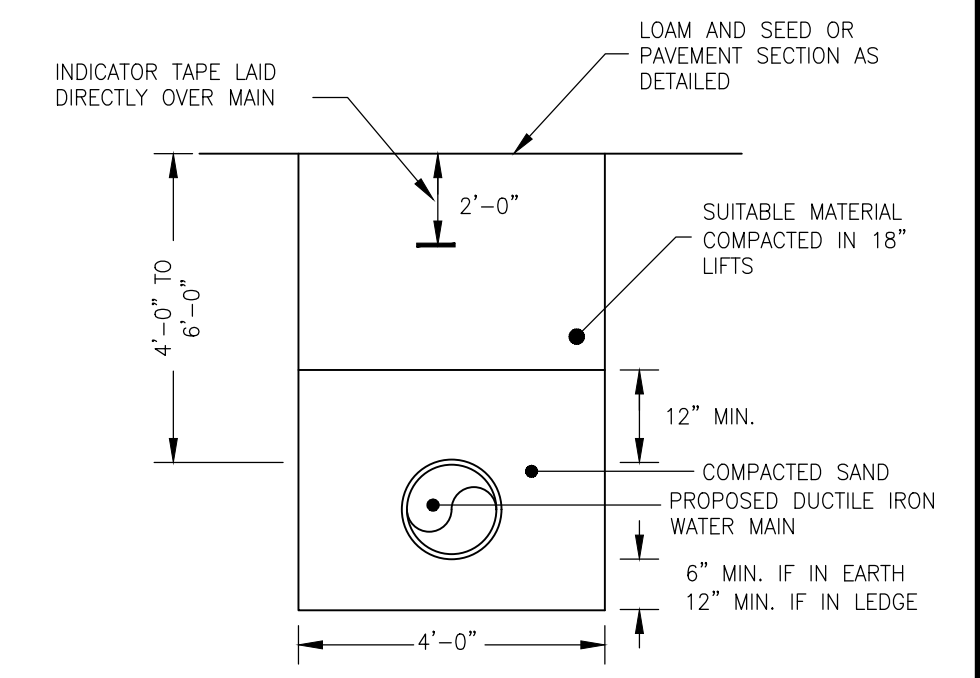

WATER MAIN TRENCH
NOT TO SCALE

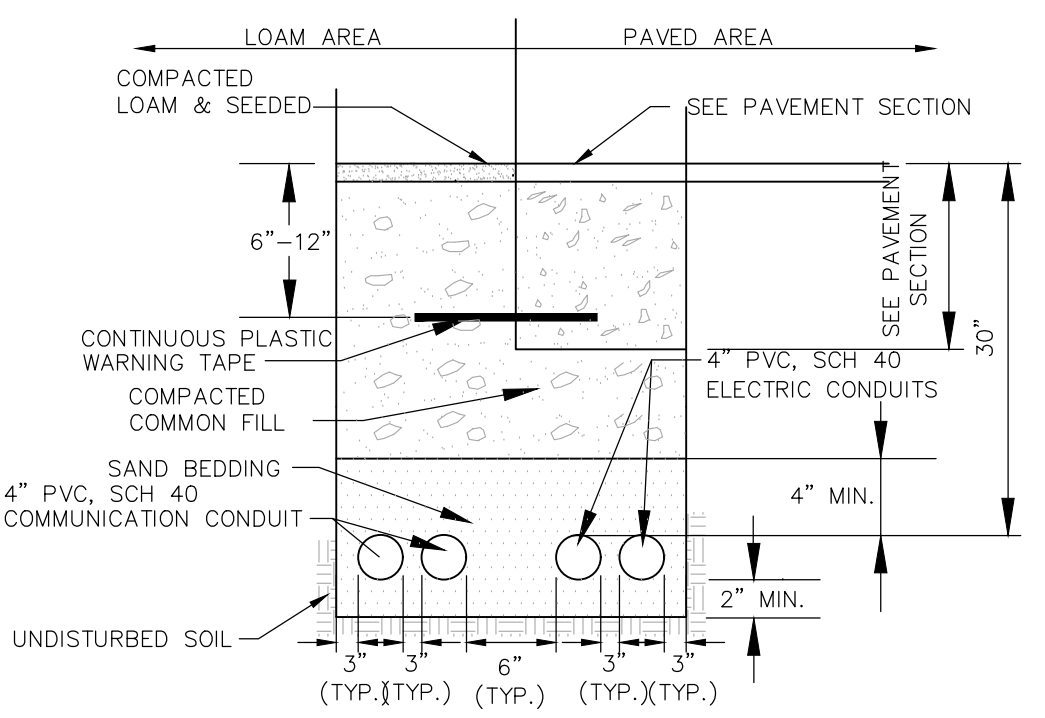

- NOTES:**
- ELECTRIC SERVICE INSTALLATION AND STANDARD DIMENSIONAL REQUIREMENTS SHALL BE IN ACCORDANCE WITH FEDERAL, STATE AND LOCAL CODES.
 - COMMUNICATION SERVICE INSTALLATION SHALL MEET ALL CONSTRUCTION REQUIREMENTS.
 - ACTUAL NUMBER OF CONDUITS TO BE DETERMINED BY RESPECTIVE COMPANIES.
 - VERIFY INSTALLATION REQUIREMENTS WITH RESPECTIVE COMPANIES.

ELECTRIC/COMMUNICATIONS CONDUIT
NOT TO SCALE

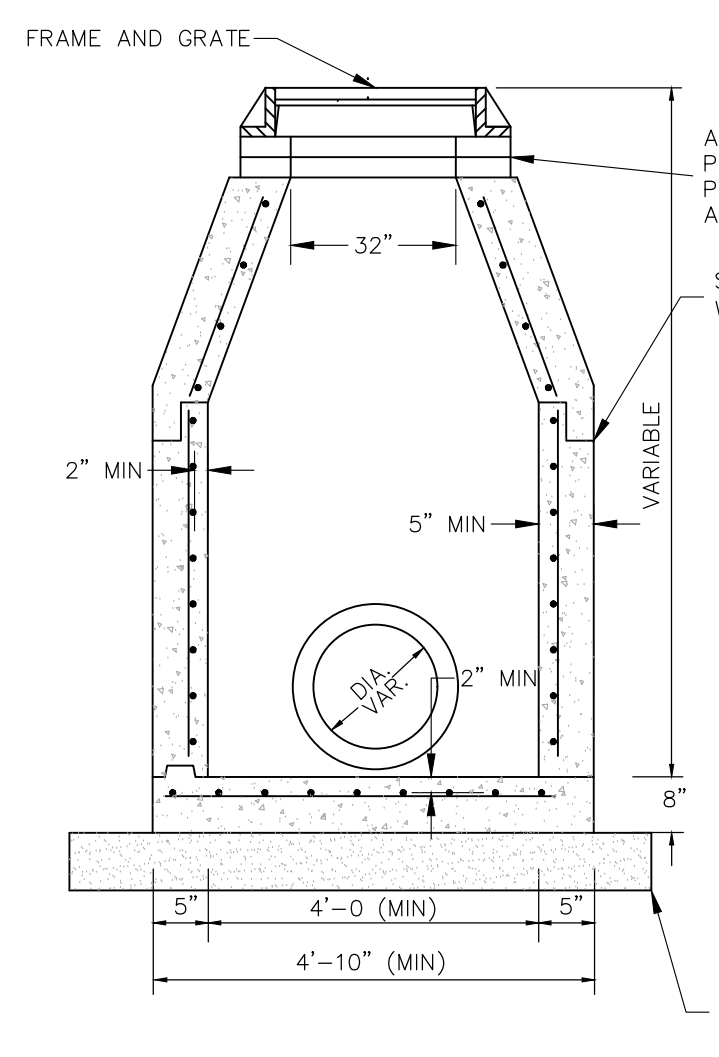

- NOTES:**
- MANHOLE FRAME & COVER: SHALL BE NEENAH R-1653A OR APPROVED EQUAL.
 - ALL COMPONENTS OF MANHOLES SHALL MEET NHDOT SPECIFICATIONS AND THE COVER SHALL HAVE THE WORD "DRAIN" STAMPED ON IT.
 - ALL COMPONENTS SHALL BE DESIGNED FOR HS-20 LOADING.
 - REINFORCING SHALL CONFORM TO ASTM 185 OR ASTM 1497 & ASTM A615, GRADE 60.
 - ALL CONCRETE SHALL BE NHDOT CLASS A.
 - LARGER DIAMETER STRUCTURES SHALL BE USED AS REQUIRED DUE TO NUMBER, ANGLE OR SIZE OF PIPES AT THE STRUCTURE.
 - ALL CASTINGS SHALL BE MADE IN THE USA.

DRAIN MANHOLE
NOT TO SCALE

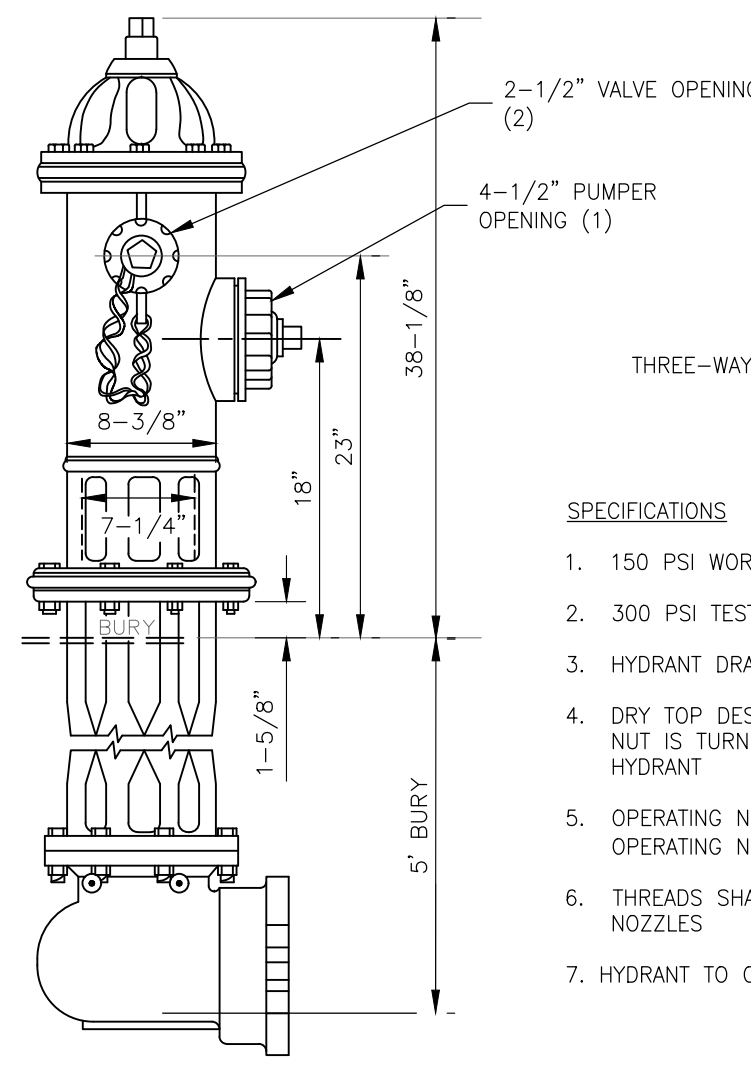

- SPECIFICATIONS**
- 150 PSI WORKING PRESSURE
 - 300 PSI TEST PRESSURE
 - HYDRANT DRAIN SHALL BE PLUGGED
 - DRY TOP DESIGN VALVE SHALL OPEN WHEN OPERATING NUT IS TURNED CLOCKWISE AND BE SO INDICATED ON HYDRANT
 - OPERATING NUT SHALL BE STANDARD AWWA PENTAGON OPERATING NUT WITH 1 1/2" POINT TO FLAT DIMENSION
 - THREADS SHALL BE NATIONAL STANDARD HOSE THREAD NOZZLES
 - HYDRANT TO OPEN RIGHT.

PORTSMOUTH FIRE HYDRANT
NOT TO SCALE

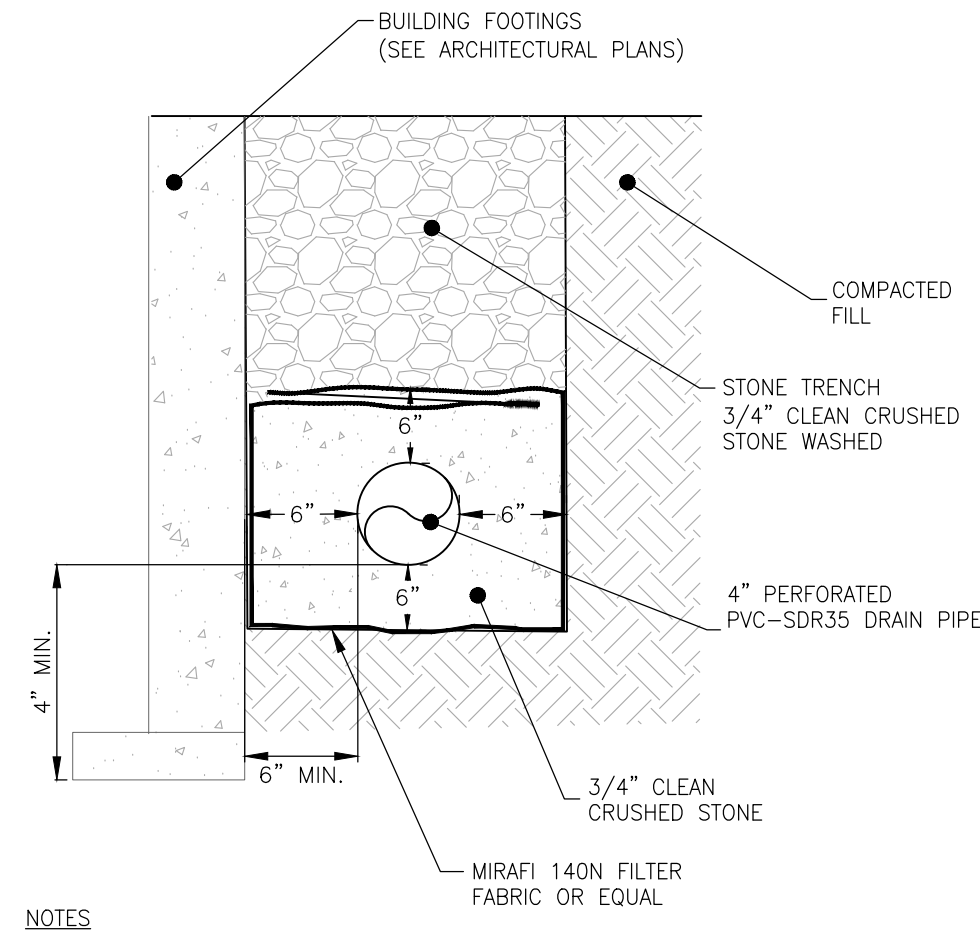

- NOTES:**
- FOR MINIMUM DIMENSIONAL REQUIREMENT REFER TO THE GEOTECHNICAL REPORT PREPARED BY JOHN TURNER CONSULTING, INC. ON JULY 3, 2013.

FOUNDATION DRAIN LINES
NOT TO SCALE

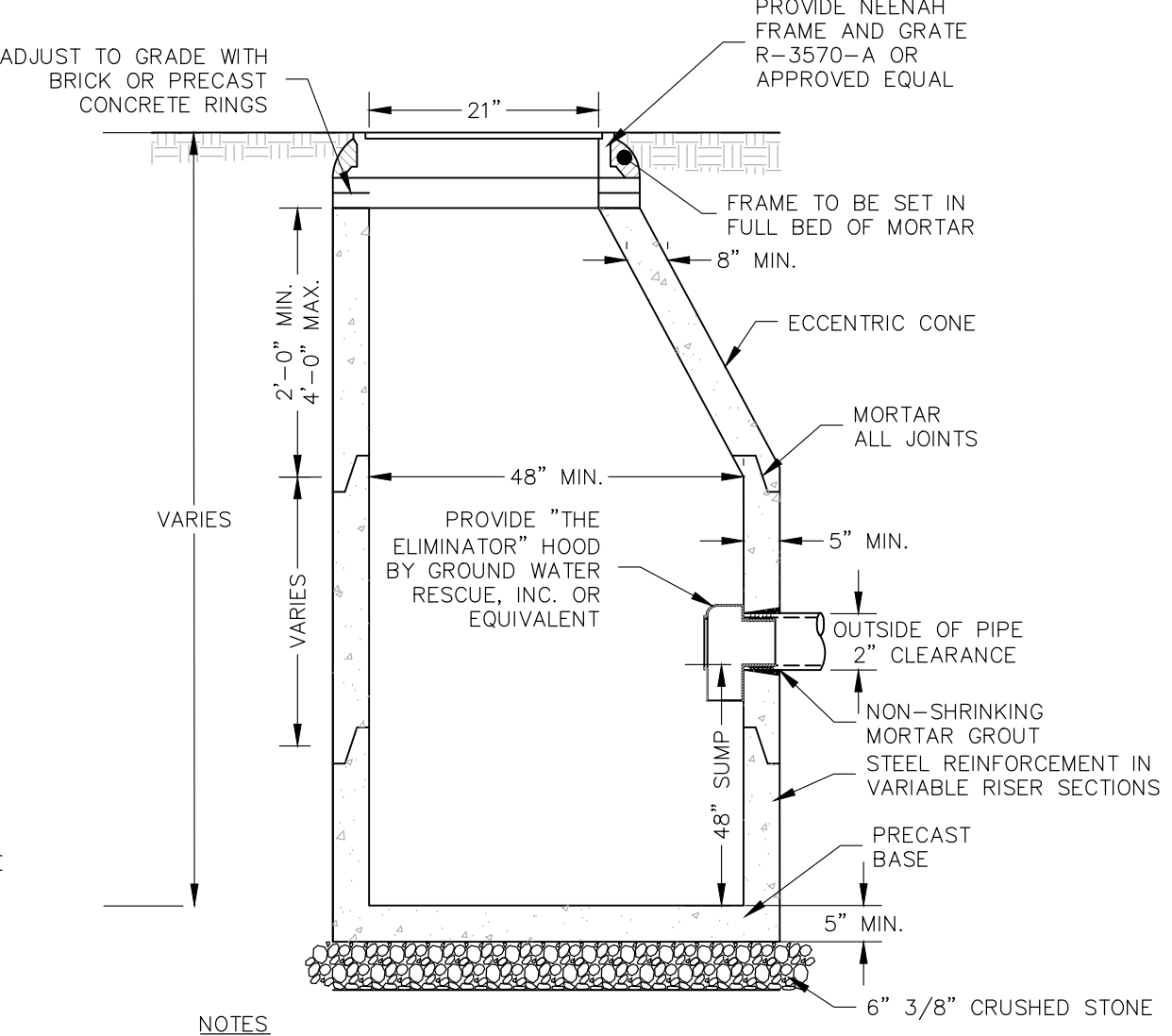

- NOTES:**
- ALL SECTIONS SHALL BE PRECAST CONCRETE NHDOT CLASS AA, 4,000 PSI.
 - ALL COMPONENTS OF CATCH BASINS SHALL MEET NHDOT SPECIFICATIONS.
 - ALL COMPONENTS SHALL BE DESIGNED FOR HS-20 LOADING.
 - LARGER DIAMETER STRUCTURES SHALL BE USED AS REQUIRED DUE TO NUMBER, ANGLE OR SIZE OF PIPES AT THE STRUCTURE.
 - ALL CASTINGS SHALL BE MADE IN THE USA.

ECCENTRIC CATCH BASIN WITH HOODED OUTLET
NOT TO SCALE

TRENCH FOR DRAIN LINE
NOT TO SCALE

- NOTES:**
- BEDDING - BEDDING FOR PIPES SHALL CONSIST OF PREPARING THE BOTTOM OF THE TRENCH TO SUPPORT THE ENTIRE LENGTH OF THE PIPE AT A UNIFORM SLOPE AND ALIGNMENT. CRUSHED STONE SHALL BE USED TO BED THE PIPE TO THE ELEVATION SHOWN ON THE DRAWINGS. NORMAL PIPE BEDDING IS CRUSHED STONE TO THE HAUNCH OF THE PIPE AND SAND BEDDING 6" ABOVE THE CROWN. IF THE TOP OF THE PIPE IS LESS THAN 30" FROM FINISH GRADE, BED PIPE COMPLETELY IN STONE UP TO 6" ABOVE PIPE CROWN. UNDERDRAIN TO HAVE 4" MINIMUM OF STONE OVER PIPE OR AS NECESSARY TO BE IN CONTACT WITH GRAVEL LAYER OF SELECTS ABOVE.
 - COMPACTION - ALL BACKFILL SHALL BE COMPACTED AT OR NEAR OPTIMUM MOISTURE CONTENT BY PNEUMATIC TAMPERS, VIBRATORY COMPACTORS OR OTHER APPROVED MEANS. BACKFILL BENEATH PAVED SURFACES SHALL BE COMPACTED TO NOT LESS THAN 95% OF AASHTO T99, METHOD C.
 - SUITABLE MATERIAL - IN ROADS, ROAD SHOULDERS, WALKWAYS AND TRAVELED WAYS, SUITABLE MATERIAL FOR TRENCH BACKFILL SHALL BE THE NATURAL MATERIAL EXCAVATED DURING THE COURSE OF CONSTRUCTION, BUT SHALL EXCLUDE DEBRIS; PIECES OF PAVEMENT; ORGANIC MATTER; TOP SOIL; ALL WET OR SOFT MUCK, PEAT, OR CLAY; ALL EXCAVATED LEDGE MATERIAL; ROCKS OVER 6" IN LARGEST DIMENSION; FROZEN EARTH AND ANY MATERIAL WHICH, AS DETERMINED BY THE ENGINEER, WILL NOT PROVIDE SUFFICIENT SUPPORT OR MAINTAIN THE COMPLETED CONSTRUCTION IN A STABLE CONDITION.
 - BASE COURSE AND PAVEMENT - SHALL MEET THE REQUIREMENT OF THE NHDOT LATEST EDITION OF THE STANDARD SPECIFICATIONS FOR HIGHWAYS AND BRIDGES DIVISION 300 AND 400 RESPECTIVELY.

SITE DEVELOPMENT PLANS

TAX MAP 256 LOT 2
DETAILS
THE VILLAGE AT BANFIELD WOODS
PORTSMOUTH, NH
OWNED BY
WALTER D HETT TRUST
PREPARED FOR
GREEN & COMPANY REAL ESTATE

SCALE: NTS SEPTEMBER 25, 2019

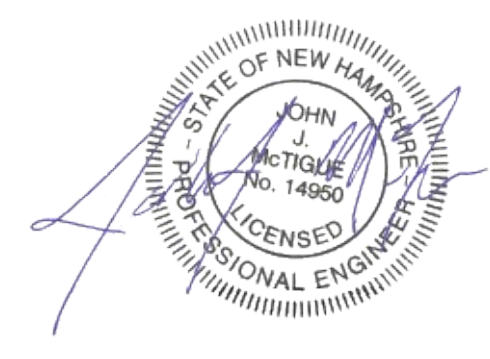

REV	DATE	DESCRIPTION	DR	CK
6	5/5/2020	AoT SUBMITTAL	RCK	JJM
5	4/29/2020	REVISOR PER REGULATORY COMMENTS	RCK	JJM
4	3/20/2020	PROGRESS PRINT	RCK	JJM
3	3/4/2020	UPDATE PLANS PER REGULATORY COMMENTS	RCK	JJM
2	12/27/2019	IN HOUSE REVISIONS	RCK	JJM
1	12/23/19	NO REVISIONS THIS SHEET	RCK	JJM

TFM Civil Engineers
Structural Engineers
Traffic Engineers
Land Surveyors
Landscape Architects
Scientists

48 Constitution Drive
Bedford, NH 03110
Phone (603) 472-4488
Fax (603) 472-9747
www.tfmoran.com

47361.00 DR RCK FB
CK JJM CADFILE
DETAILS

C-34

May 28, 2020 - 12:06pm
F:\MISC Projects\47361 - Portsmouth\47361-00 - Green & Co - Banfield Road\Design\Production Drawings\Details.dwg

Copyright 2019 © Thomas F. Moran, Inc.
48 Constitution Drive, Bedford, N.H. 03110
All rights reserved. These plans and materials may not be copied, duplicated, replicated or otherwise reproduced in any form whatsoever without the prior written permission of Thomas F. Moran, Inc.
This plan is not effective unless signed by a duly authorized officer of Thomas F. Moran, Inc.



May 28, 2020 - 12:06pm F:\MSC Projects\47381 - Portsmouth\47381-00 - Green & Co - Banfield Road\Design\Production Drawings\Details.dwg

END VIEW OF PIPE/FABRIC CONNECTION. CUT AN "X" IN THE FABRIC SLIGHTLY LARGER THAN PIPE, PULL THE FABRIC AROUND THE PIPE TO CREATE THE "BOOT" AND THEN SECURE WITH A HOSE-CLAMP.

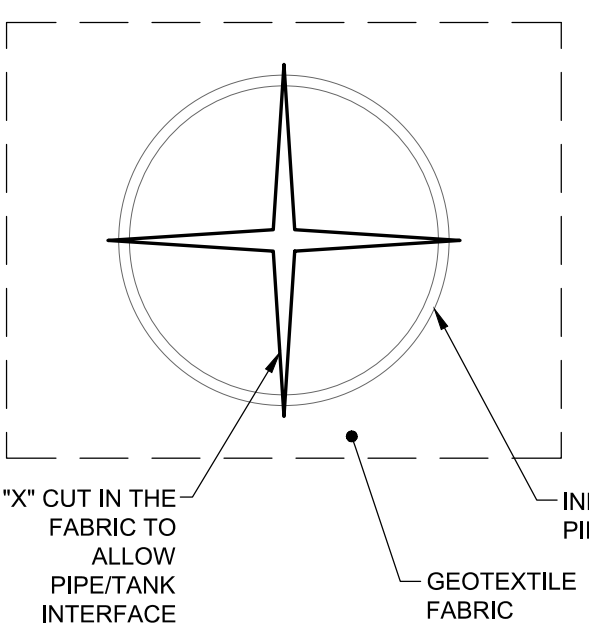

"X" CUT IN THE FABRIC TO ALLOW PIPE/TANK INTERFACE
 INLET/OUTLET PIPE
 GEOTEXTILE FABRIC

NOTE
 1. SEE DRAINAGE PLAN FOR LOCATIONS AND ELEVATIONS

R-TANK^{SD} TYPICAL TANK INLET/OUTLET DETAIL
 NOT TO SCALE

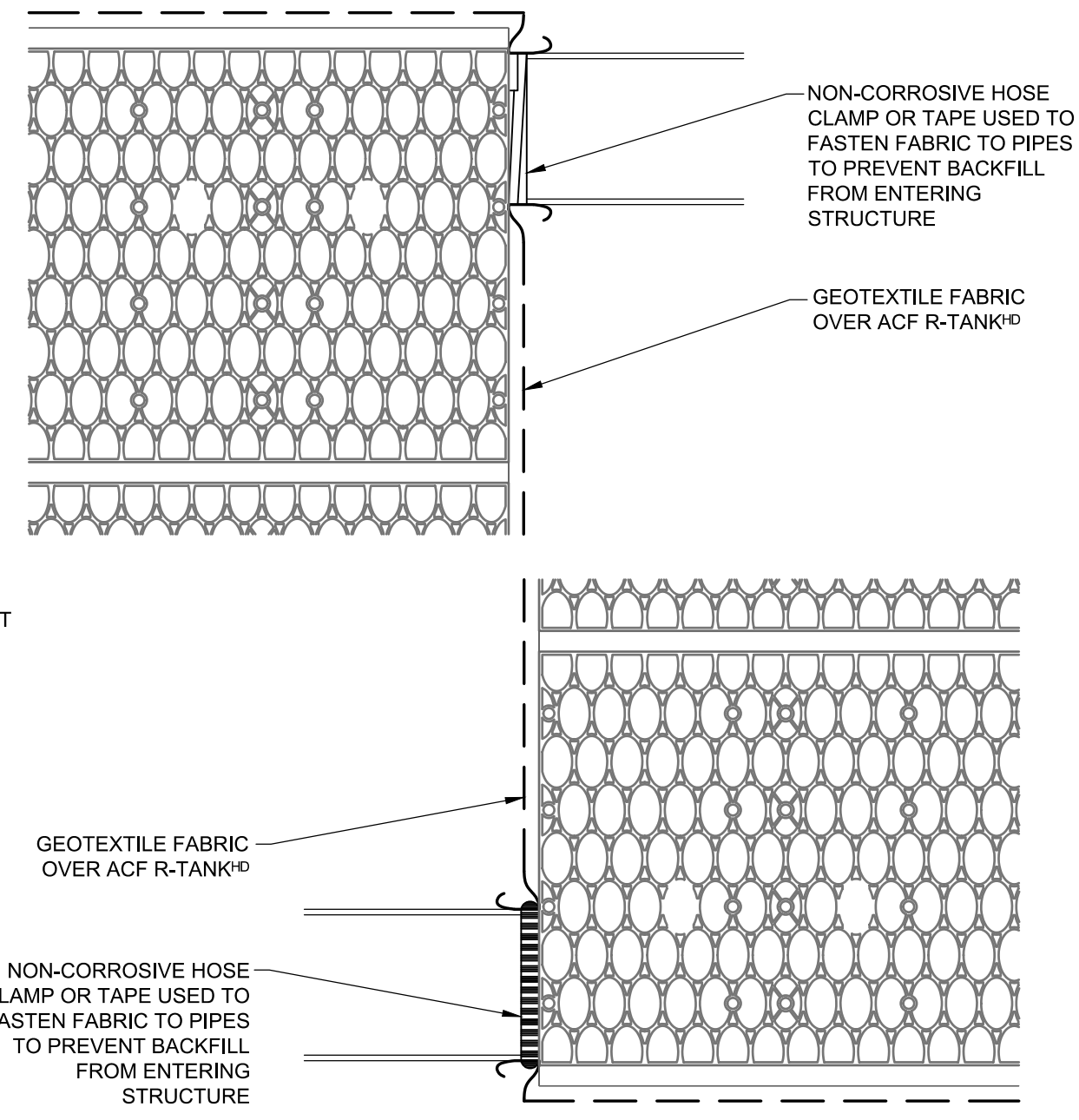

NON-CORROSIVE HOSE CLAMP OR TAPE USED TO FASTEN FABRIC TO PIPES TO PREVENT BACKFILL FROM ENTERING STRUCTURE

GEOTEXTILE FABRIC OVER ACF R-TANK^{SD}

GEOTEXTILE FABRIC OVER ACF R-TANK^{SD}

NON-CORROSIVE HOSE CLAMP OR TAPE USED TO FASTEN FABRIC TO PIPES TO PREVENT BACKFILL FROM ENTERING STRUCTURE

NYLOPLAST 12" UNDERDRAIN FLUSHING PORT: TRAFFIC RATED INSTALLATION

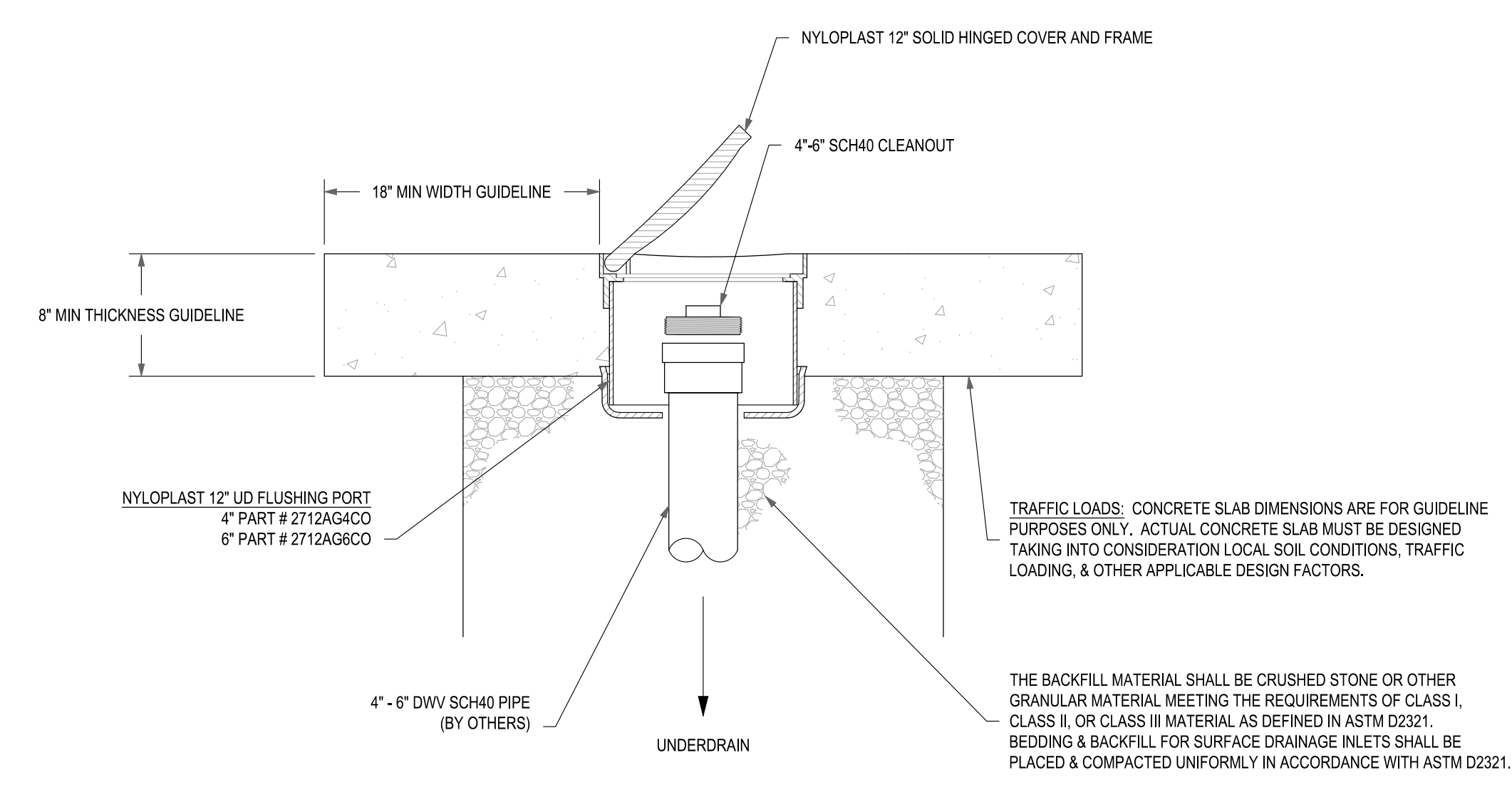

NYLOPLAST 12" SOLID HINGED COVER AND FRAME

4"-6" SCH40 CLEANOUT

18" MIN WIDTH GUIDELINE

8" MIN THICKNESS GUIDELINE

NYLOPLAST 12" UD FLUSHING PORT
 4" PART # Z712AG4CO
 6" PART # Z712AG6CO

4" - 6" DWV SCH40 PIPE (BY OTHERS)

UNDERDRAIN

TRAFFIC LOADS: CONCRETE SLAB DIMENSIONS ARE FOR GUIDELINE PURPOSES ONLY. ACTUAL CONCRETE SLAB MUST BE DESIGNED TAKING INTO CONSIDERATION LOCAL SOIL CONDITIONS, TRAFFIC LOADING, & OTHER APPLICABLE DESIGN FACTORS.

THE BACKFILL MATERIAL SHALL BE CRUSHED STONE OR OTHER GRANULAR MATERIAL MEETING THE REQUIREMENTS OF CLASS I, CLASS II, OR CLASS III MATERIAL AS DEFINED IN ASTM D2321. BEDDING & BACKFILL FOR SURFACE DRAINAGE INLETS SHALL BE PLACED & COMPACTED UNIFORMLY IN ACCORDANCE WITH ASTM D2321.

THIS PRINT DISCLOSES SUBJECT MATTER IN WHICH NYLOPLAST HAS PROPRIETARY RIGHTS. THE RECEIPT OR POSSESSION OF THIS PRINT DOES NOT CONFER, TRANSFER, OR LICENSE THE USE OF THE DESIGN OR TECHNICAL INFORMATION SHOWN HEREIN. REPRODUCTION OF THIS PRINT OR ANY INFORMATION CONTAINED HEREIN, OR MANUFACTURE OF ANY ARTICLE HEREFROM, FOR THE DISCLOSURE TO OTHERS IS FORBIDDEN, EXCEPT BY SPECIFIC WRITTEN PERMISSION FROM NYLOPLAST. ©2012 NYLOPLAST		DRAWN BY CCA DATE 7-27-12 REVISED BY NIMH DATE 03-16-16 DWG SIZE A SCALE 1:10 SHEET 1 OF 1	MATERIAL PROJECT NO./NAME TITLE INSPECTION PORT FOR STORMTECH SYSTEMS - TRAFFIC RATED INSTALLATION DWG NO. 7003-110-065 REV C	3130 VERONA AVE BUFORD, GA 30518 PHN (770) 932-2443 FAX (770) 932-2490 www.nyloplast-us.com
--	--	--	--	---

Copyright 2019 © Thomas F. Moran, Inc.
 48 Constitution Drive, Bedford, N.H. 03110
 All rights reserved. These plans and materials may not be copied, duplicated, replicated or otherwise reproduced in any form whatsoever without the prior written permission of Thomas F. Moran, Inc.
 This plan is not effective unless signed by a duly authorized officer of Thomas F. Moran, Inc.

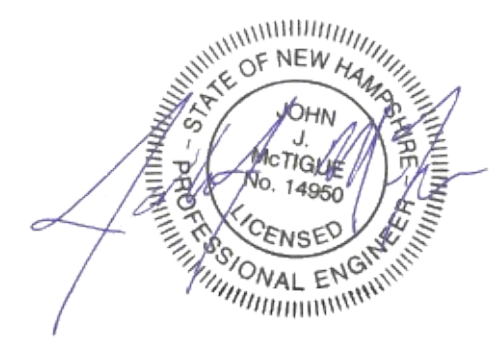

SITE DEVELOPMENT PLANS

TAX MAP 256 LOT 2
DETAILS
THE VILLAGE AT BANFIELD WOODS
PORTSMOUTH, NH
 OWNED BY
WALTER D HETT TRUST
 PREPARED FOR
GREEN & COMPANY REAL ESTATE

SCALE: NTS SEPTEMBER 25, 2019

REV	DATE	DESCRIPTION	DR	CK
6	5/5/2020	AoT SUBMITTAL	RCK	JJM
5	4/29/2020	REVISOR PER REGULATORY COMMENTS	RCK	JJM
4	3/20/2020	PROGRESS PRINT	RCK	JJM
3	3/4/2020	UPDATE PLANS PER REGULATORY COMMENTS	RCK	JJM
2	12/27/2019	IN HOUSE REVISIONS	RCK	JJM
1	12/23/19	NO REVISIONS THIS SHEET	RCK	JJM

Civil Engineers Structural Engineers Traffic Engineers Land Surveyors Landscape Architects Scientists	48 Constitution Drive Bedford, NH 03110 Phone (603) 472-4488 Fax (603) 472-9747 www.tfmoran.com
	FILE 47361.00 DR RCK FB CK JJM CADFILE DETAILS C-35

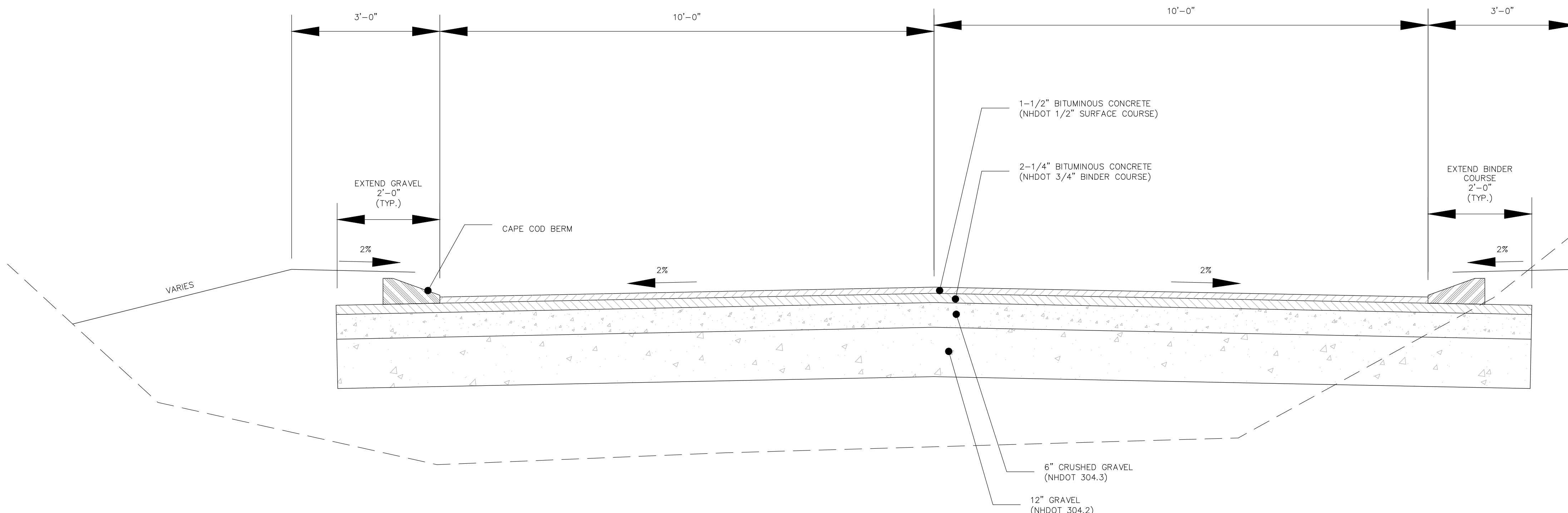

ROADWAY TYPICAL SECTION
NOT TO SCALE

- NOTES:**
- SEE GRADING & DRAINAGE PLAN FOR PAVEMENT SLOPE AND CROSS-SLOPE.
 - PROVIDE CLEAN BUTT TO EXISTING PAVEMENT— USE TACK COAT SPECIFICALLY, A TACK COAT SHALL BE PLACED ATOP THE BINDER COURSE PAVEMENT PRIOR TO PLACING THE WEARING COURSE.
 - REMOVE ALL LOAM AND/OR YIELDING MATERIAL BELOW PAVEMENT.
 - ALL ROADWAY TO CONFORM TO THE STREET DESIGN AND CONSTRUCTION REQUIREMENTS IN THE TOWN OF PORTSMOUTH, NH SUBDIVISION REGULATIONS.
 - BITUMINOUS CONCRETE SHALL BE COMPACTED TO AT LEAST 92.5% OF THEORETICAL MAXIMUM DENSITY AS DETERMINED BY ASTM D2041 OR AASHTO T209. PLACEMENT TEMPERATURES OF BITUMINOUS CONCRETE MIXES, IN GENERAL, RANGE BETWEEN 270 AND 310 DEGREES FAHRENHEIT.
 - PAVEMENT BASE COURSE AGGREGATE SHALL CONFORM TO NHDOT SPECIFICATION SECTION 304, ITEM 304.4 AND COMPACTED TO A MINIMUM OF 95% OF MODIFIED PROCTOR MAXIMUM DRY DENSITY.
 - PAVEMENT SUBBASE COURSE AGGREGATE AND AGGREGATE FOR SUBGRADE REPAIR AREAS SHALL BE SUITABLE FOR USE AS STRUCTURAL FILL AND BE PROOF ROLLED AND COMPACTED TO 95% MODIFIED PROCTOR MAXIMUM DRY DENSITY.
 - THE EXPOSED SOIL SUBGRADE SHOULD BE PROOF ROLLED PRIOR TO THE PLACEMENT OF SUBBASE GRAVEL, AND SOFT AREAS SHOULD BE REPAIRED AND REPLACED.

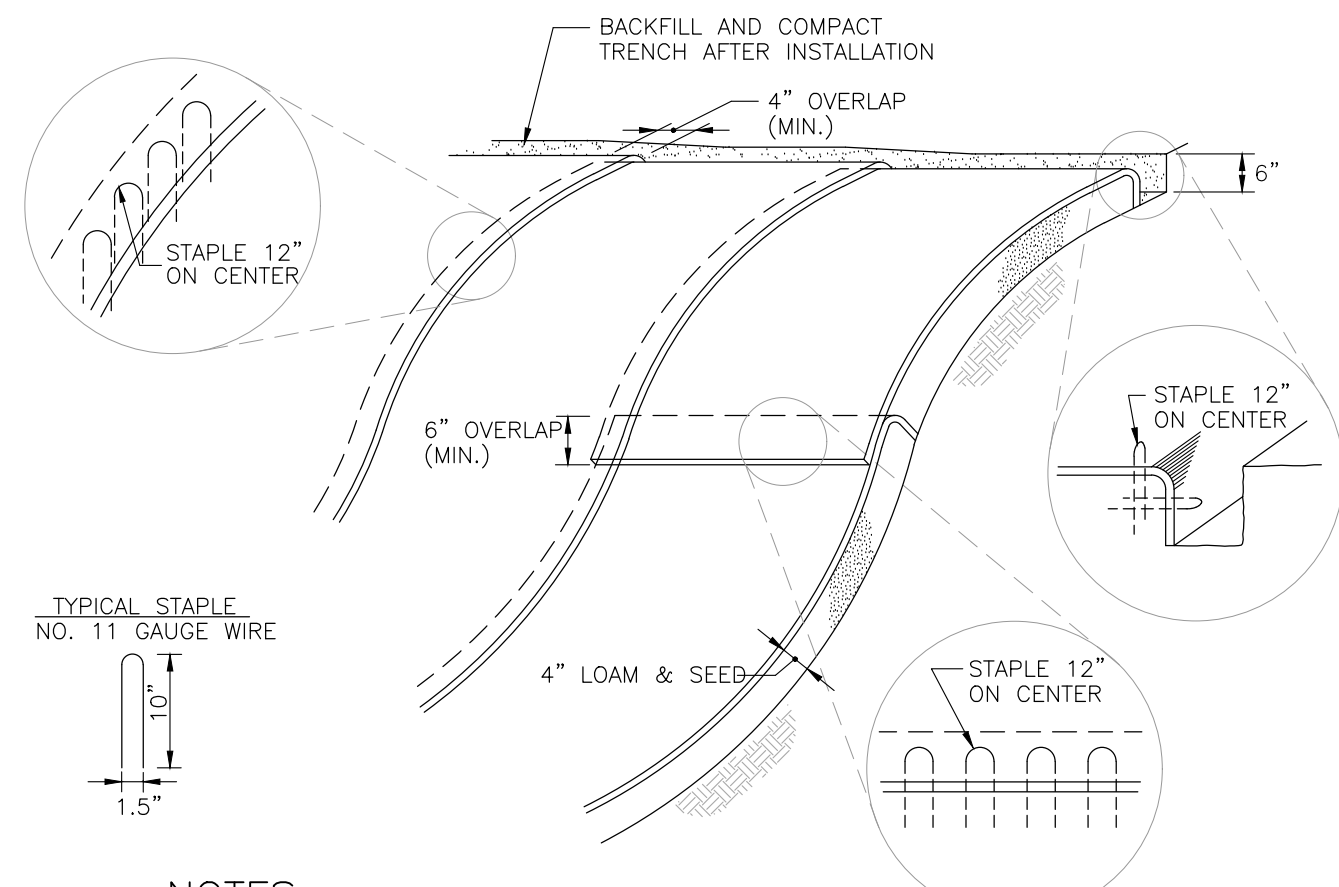

- NOTES**
- BEGIN AT THE TOP OF BLANKET INSTALLATION AREA BY ANCHORING BLANKET IN A 6" DEEP TRENCH. BACKFILL AND COMPACT TRENCH AFTER STAPLING.
 - ROLL THE BLANKET DOWN THE SWALE IN THE DIRECTION OF THE WATER FLOW.
 - THE EDGES OF BLANKETS MUST BE STAPLED WITH APPROX. 4 INCH OVERLAP WHERE 2 OR MORE STRIP WIDTHS ARE REQUIRED.
 - WHEN BLANKETS MUST BE SPICED DOWN THE SWALE, PLACE BLANKET END OVER END WITH 6 INCH (MIN.) OVERLAP AND ANCHOR DOWN SLOPE BLANKET IN A 6 INCH DEEP TRENCH.
 - BLANKET SHALL BE NORTH AMERICAN GREEN C125BN, EAST COAST EROSION CONTROL ECC-2B, AMERICAN EXCELSIOR COMPANY CURLEX III FIBRENET, ROLANKA GEONATURAL EROSION & SEDIMENT CONTROL MATTE JUTEMAT OR BI0D-OCF 30, OR APPROVED EQUAL.

BLANKET SLOPE PROTECTION
FOR EROSION CONTROL NOT TO SCALE

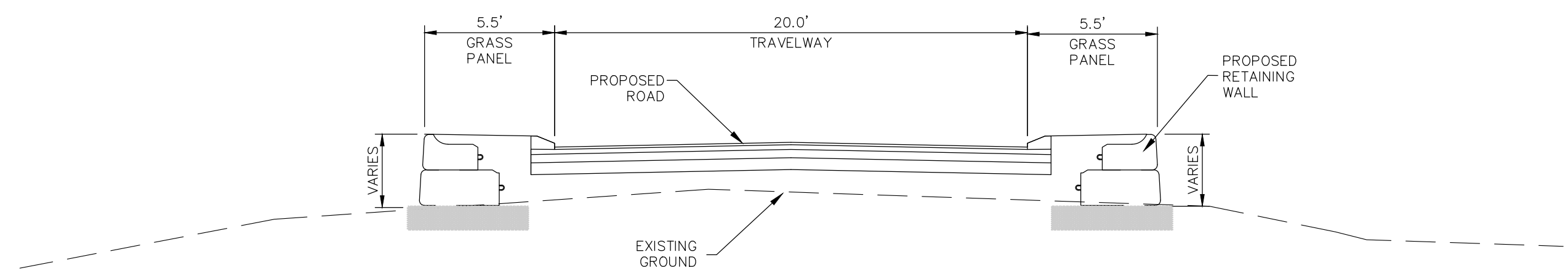

- NOTES:**
- PROPOSED RETAINING WALL TO BE DESIGNED AND STAMPED BY A LICENSED PROFESSIONAL ENGINEER PRIOR TO CONSTRUCTION.
 - RETAINING WALL DESIGN SHALL BE SUBMITTED TO THE CITY OF PORTSMOUTH FOR APPROVAL.

RETAINING WALL TYPICAL SECTION
NOT TO SCALE

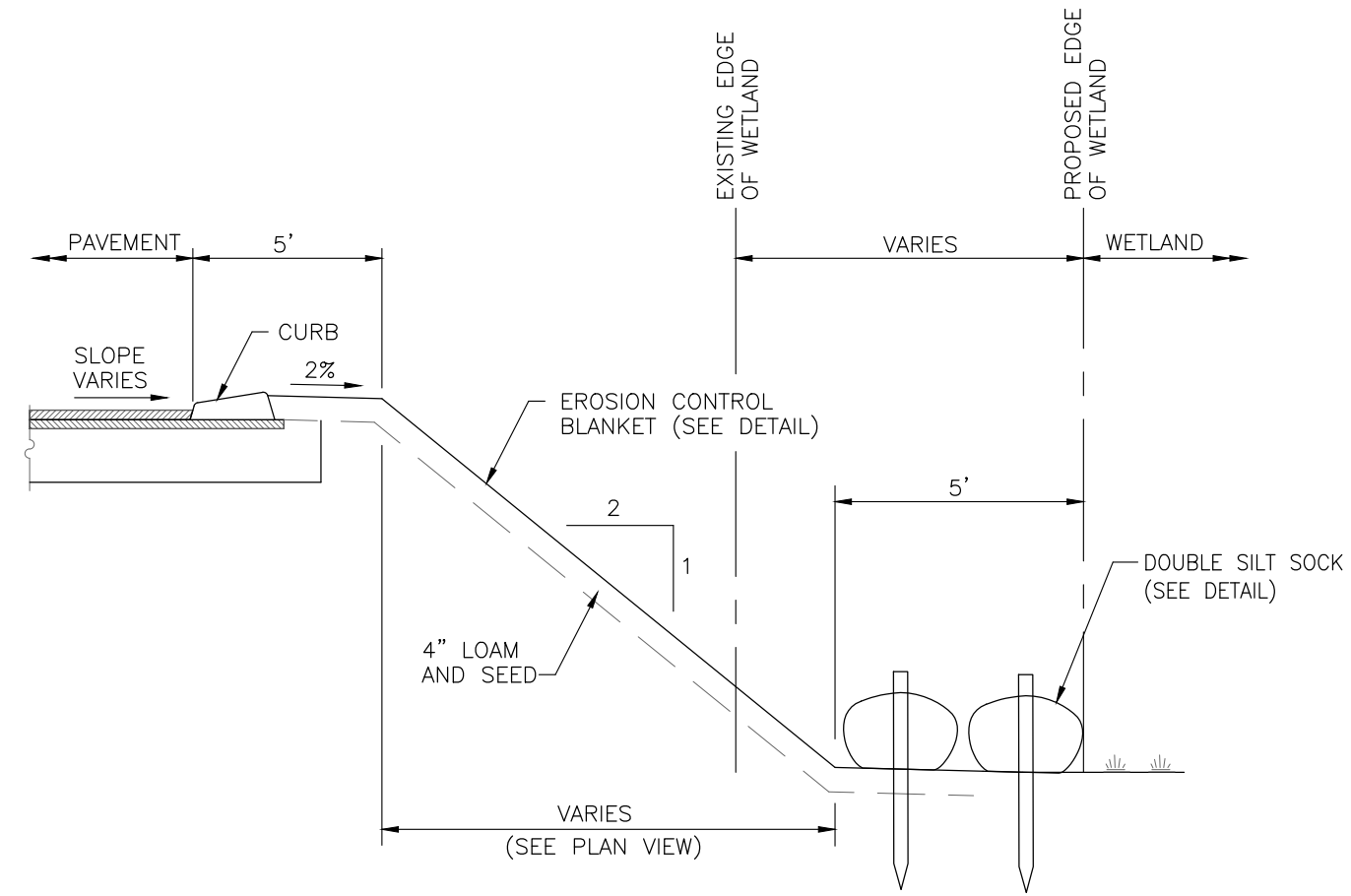

SLOPE STABILIZATION ADJACENT TO WETLANDS
FOR EROSION CONTROL NOT TO SCALE

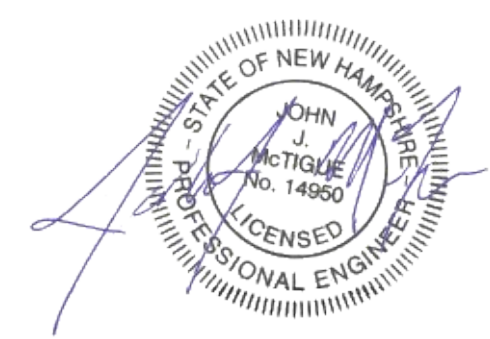

SITE DEVELOPMENT PLANS
TAX MAP 256 LOT 2
DETAILS
THE VILLAGE AT BANFIELD WOODS
PORTSMOUTH, NH
OWNED BY
WALTER D HETT TRUST
PREPARED FOR
GREEN & COMPANY REAL ESTATE
SCALE: NTS SEPTEMBER 25, 2019

REV	DATE	DESCRIPTION	DR	CK
6	5/5/2020	AoT SUBMITTAL	RCK	JJM
5	4/29/2020	REVISOR PER REGULATORY COMMENTS	RCK	JJM
4	3/20/2020	PROGRESS PRINT	RCK	JJM
3	3/4/2020	UPDATE PLANS PER REGULATORY COMMENTS	RCK	JJM
2	12/27/2019	IN HOUSE REVISIONS	RCK	JJM
1	12/23/19	NO REVISIONS THIS SHEET	RCK	JJM

TFM Civil Engineers
Structural Engineers
Traffic Engineers
Land Surveyors
Landscape Architects
Scientists
48 Constitution Drive
Bedford, NH 03110
Phone (603) 472-4488
Fax (603) 472-9747
www.tfmoran.com

FILE 47361.00 DR RCK FB
CK JUM CADFILE DETAILS C-36

May 28, 2020 - 12:07pm F:\MISC Projects\47361 - Portsmouth\47361-00 - Green & Co - Banfield Road\Design\Production Drawings\Details.dwg

Copyright 2019 © Thomas F. Moran, Inc.
48 Constitution Drive, Bedford, N.H. 03110
All rights reserved. These plans and materials may not be copied, duplicated, replicated or otherwise reproduced in any form whatsoever without the prior written permission of Thomas F. Moran, Inc.
This plan is not effective unless signed by a duly authorized officer of Thomas F. Moran, Inc.

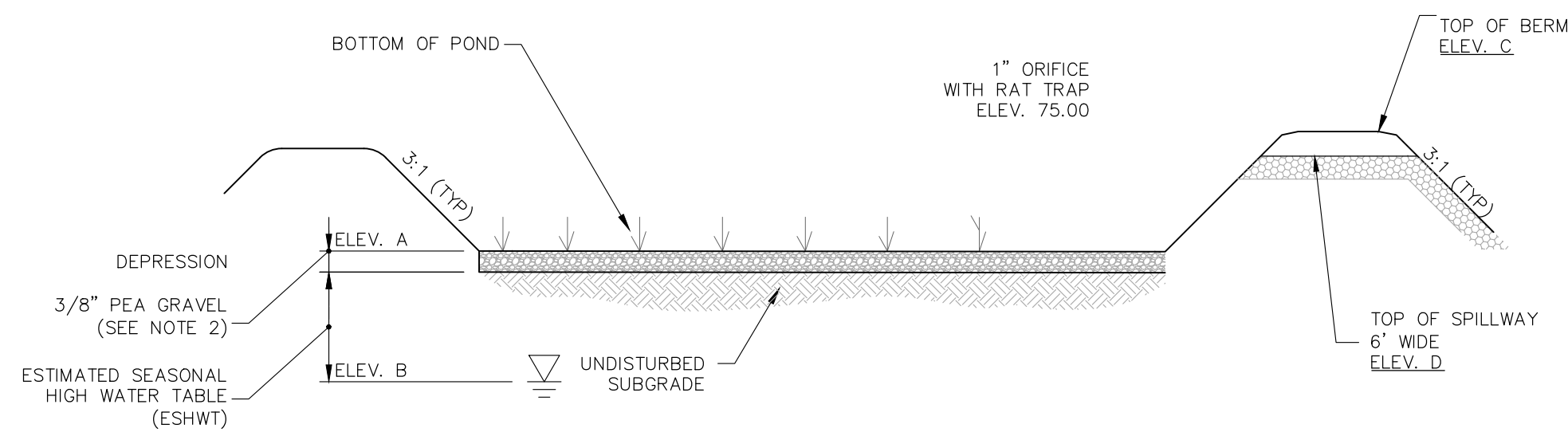

ELEVATION	INFIL. BASIN #1	INFIL. BASIN #2
A	44.00	63.00
B	42.80	62.00
C	46.50	65.50
D	45.50	64.50

INFILTRATION BASIN CONSTRUCTION

- CLEAR AND GRUB THE AREA WHERE THE INFILTRATION BASIN IS TO BE LOCATED. STOCKPILE LOAM FOR REUSE ON SLOPES.
- GRADE INFILTRATION AREA ACCORDING TO PLAN AND DETAILS. SIDE SLOPES SHALL HAVE 6" LOAM AND SEED AND A SLOPE NOT TO EXCEED 2:1. BOTTOM OF INFILTRATION BASIN TO BE CONSTRUCTED WITH ONE OF THE FOLLOWING:
 - A 6-INCH LAYER OF COARSE SAND OR 3/8 INCH PEA GRAVEL;
 - GRASS THAT CAN SURVIVE INUNDATION FOR UP TO 72 HOURS AND STILL PROVIDE A DENSE, VIGOROUS TURF LAYER; OR
 - A LAYER OF COARSE ORGANIC MATERIAL, SUCH AS EROSION CONTROL MIX OR COMPOSTED MULCH, THAT IS TILLED INTO THE SOIL, SOAKED, AND ALLOWED TO DRY.
- THE CONTRACTOR SHALL TAKE MEASURES TO PREVENT EQUIPMENT & VEHICLE TRAFFIC FROM DRIVING IN THE AREA OF THE PROPOSED RAIN GARDEN AREA DURING CONSTRUCTION.
- BOTTOM OF BASIN IS TO BE ROTOTILLED PRIOR TO INSTALLING PEA GRAVEL OR COARSE SAND.

INFILTRATION BASIN MAINTENANCE

MAINTENANCE SCHEDULE TO BEGIN AFTER CONSTRUCTION IS FINISHED AND BASIN STABILIZATION IS COMPLETE.

- CONTRACTOR AND LAND OWNERS TO PERFORM SCHEDULED MAINTENANCE ON THE INFILTRATION BASINS IN ACCORDANCE WITH THE STORMWATER OPERATION AND MAINTENANCE MANUAL.

INFILTRATION BASIN DETAIL

NOT TO SCALE

NOTE: SEE PLANS FOR BED, BERM AND OVERFLOW ELEVATIONS

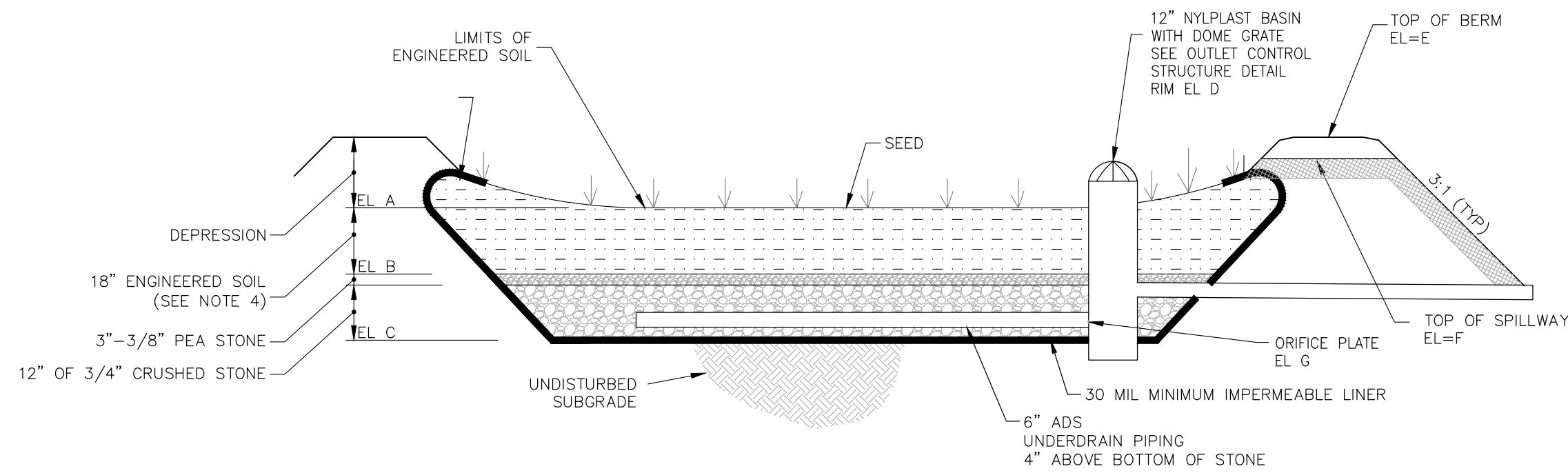

ELEVATION TABLE	
BIORETENTION #1	
A	56.00
B	54.50
C	53.17
D	57.50
E	58.00
F	58.10 (Road)
G	53.20 (0.2')

BIORETENTION SYSTEM MAINTENANCE

MAINTENANCE SCHEDULE TO BEGIN AFTER CONSTRUCTION IS FINISHED AND BASIN STABILIZATION IS COMPLETE.

- CONTRACTOR AND LAND OWNERS TO PERFORM SCHEDULED MAINTENANCE ON THE BIORETENTION SYSTEM IN ACCORDANCE WITH THE STORMWATER OPERATION AND MAINTENANCE MANUAL.

BIORETENTION DETAIL

NOT TO SCALE

NOTE: SEE PLANS FOR BED, BERM AND OVERFLOW ELEVATIONS

BIORETENTION SYSTEM CONSTRUCTION

- CLEAR AND GRUB THE AREA WHERE THE BIORETENTION SYSTEMS ARE TO BE LOCATED. STOCKPILE LOAM FOR REUSE ON SLOPES.
- GRADE BIORETENTION SYSTEM ACCORDING TO PLAN AND DETAILS. SIDE SLOPES SHALL HAVE 6" LOAM AND SEED AND A SLOPE NOT TO EXCEED 3:1. BOTTOM OF BIORETENTION SYSTEM AREAS TO BE CONSTRUCTED WITH MANUFACTURED SOIL (SEE BIORETENTION SYSTEM CONSTRUCTION DETAIL).
- BOTTOM OF THE BIORETENTION SYSTEM TO BE SEEDED WITH NEW ENGLAND EROSION CONTROL/RESTORATION MIX THAT MEETS NH STATE STANDARDS.
- SOIL SPECIFICATION TO CONFORM TO THE LATEST UNH STORMWATER CENTER BIORETENTION SOIL SPECIFICATIONS. A COPY OF THE 2017 UNHSC BIORETENTION SPECIFICATION ARE INCLUDED IN THE STORMWATER OPERATION AND MAINTENANCE MANUAL.
- THE CONTRACTOR SHALL TAKE MEASURES TO PREVENT EQUIPMENT & VEHICLE TRAFFIC FROM DRIVING IN THE AREA OF THE PROPOSED BIORETENTION SYSTEM AREA DURING CONSTRUCTION.

BIORETENTION SYSTEM

NOT TO SCALE

ADS-FLEXSTORM Perforated Stainless Steel Full Trash Capture Inserts

SUPPORT FRAMING: 12 GA 304 STAINLESS STEEL FRAMING W/LIFT HANDLES AND ADJUSTABLE FLANGES.

ULTIMATE BYPASS AREA

TRASH CAPTURE BASKET: 14 GA PERFORATED STAINLESS STEEL WITH 5MM OPENINGS

FLEXSTORM FILTER FOR SQUARE/RECTANGULAR GRATES

FLEXSTORM FILTER W/BOLT ON DEFLECTOR FOR CURB OPENINGS

FLEXSTORM FILTER FOR ROUND GRATES

Installation Instructions:

- Remove grate from the drainage structure
- Clean stone and dirt from the grate support ledge (lip)
- Drop the FLEXSTORM inlet filter through the clear opening such that the flanges rest firmly on the lip of the catch basin
- Replace the grate on top of the filter framing

FLEXSTORM Performance Specifications - Full Trash Capture						
ADS P/N	Basin Size	Basket Depth	Ultimate Bypass Cap. (CFS)*	Storage Volume (ft ³)	Flow Rate when Empty (CFS)*	Flow Rate when 50% Full (CFS)*
G2HD12FTC	12x12	12"	0.5	0.7	6.8	3.0
G2HD18FTC	18x18	12"	1.8	1.7	12.2	4.5
G2HD24FTC	24x24	12"	3.0	3.1	18.6	6.3
G2HD3618FTC	36x18	12"	4.0	3.5	20.8	7.3
G2HD3624FTC	36x24	12"	4.5	5.0	25.1	8.3
G2HD36FTC	36x36**	12"	8.0	7.1	41.6	14.6

* Calculated with .33' head pressure above grate
 ** Two 36 x 18 filter baskets placed side by side

TITLE: ADS-FLEXSTORM Full Trash Capture Inserts

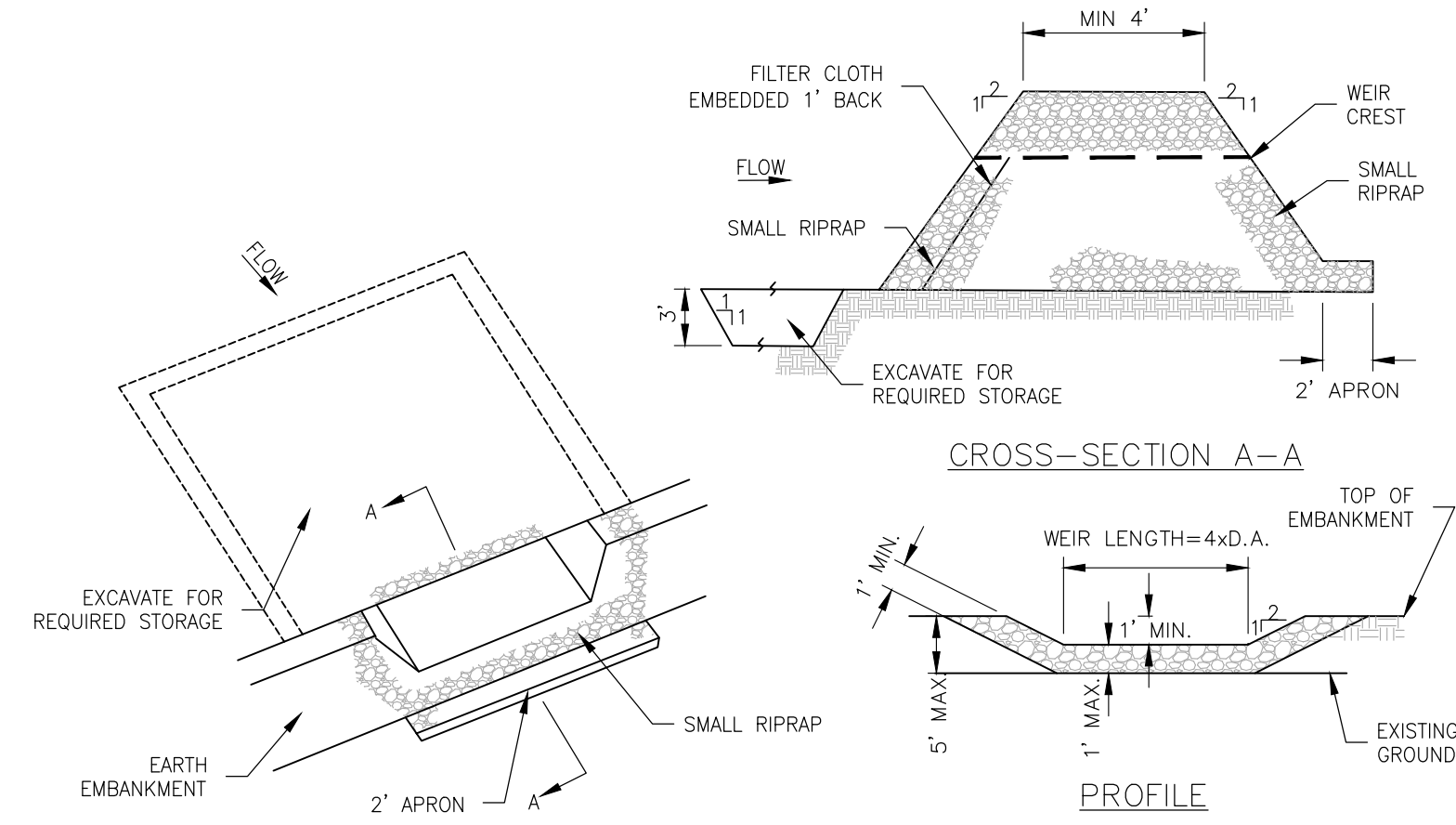

STONE OUTLET SEDIMENT TRAP					
TRAP #	DRAINAGE AREA (ACRES)	STORAGE REQUIRED (CF)	MIN. WEIR LENGTH (FT)	TOP OF TRAP DIMENSIONS (FT)	DEPTH OF TRAP (FT)
1	0.842	3,032	3.4	90x15	3
2	1.362	4,904	5.5	100x20	3

NOTES

- AREA UNDER EMBANKMENT SHALL BE CLEARED, GRUBBED AND STRIPPED OF ANY VEGETATION AND ROOT MAT. THE POOL AREA SHALL BE CLEARED.
- THE FILL MATERIAL FOR THE EMBANKMENT SHALL BE FREE OF ROOTS AND OTHER WOODY VEGETATION AS WELL AS OVER-SIZED STONES, ROCKS, ORGANIC MATERIAL OR OTHER OBJECTIONABLE MATERIAL. THE EMBANKMENT SHALL BE COMPACTED BY TRAVERSING WITH EQUIPMENT WHILE IT IS BEING CONSTRUCTED.
- ALL CUT AND FILL SLOPES SHALL BE 2:1 OR FLATTER. EXCAVATED PORTIONS OF THE SEDIMENT TRAP SHALL HAVE 1:1 OR FLATTER SLOPES.
- THE STONE USED IN THE OUTLET SHALL BE SMALL RIPRAP 4"-8" ALONG WITH A 1" THICKNESS OF 2" AGGREGATE PLACED ON THE UP-GRADE SIDE ON THE SMALL RIPRAP OR EMBEDDED FILTER CLOTH IN THE RIPRAP.
- SEDIMENT SHALL BE REMOVED AND TRAP RESTORED TO ITS ORIGINAL DIMENSIONS WHEN THE SEDIMENT HAS ACCUMULATED TO 1/2 THE DESIGN DEPTH OF THE TRAP. IT SHALL BE PLACED ON SITE AND STABILIZED.
- THE STRUCTURE SHALL BE INSPECTED AFTER EACH RAIN AND REPAIRS MADE AS NEEDED.
- CONSTRUCTION OPERATIONS SHALL BE CARRIED OUT IN SUCH A MANNER THAT EROSION AND SEDIMENT ARE CONTROLLED.
- THE STRUCTURE SHALL BE REMOVED AND THE AREA STABILIZED WHEN THE DRAINAGE AREA HAS BEEN PROPERLY STABILIZED.
- MAXIMUM DRAINAGE AREA 5 ACRES.

TEMPORARY SEDIMENT TRAP

NOT TO SCALE

SITE DEVELOPMENT PLANS

TAX MAP 256 LOT 2

DETAILS

THE VILLAGE AT BANFIELD WOODS

PORTSMOUTH, NH

OWNED BY
WALTER D HETT TRUST

PREPARED FOR
GREEN & COMPANY REAL ESTATE

SCALE: NTS

SEPTEMBER 25, 2019

Civil Engineers
 Structural Engineers
 Traffic Engineers
 Land Surveyors
 Landscape Architects
 Scientists

48 Constitution Drive
 Bedford, NH 03110
 Phone (603) 472-4488
 Fax (603) 472-9747
 www.tfmoran.com

47361.00

DR RCK FB
 CK JUM CADFILE

DETAILS

C-37

REV	DATE	DESCRIPTION	DR	CK
6	5/5/2020	AoT SUBMITTAL	RCK	JUM
5	4/29/2020	REVISOR PER REGULATORY COMMENTS	RCK	JUM
4	3/20/2020	PROGRESS PRINT	RCK	JUM
3	3/4/2020	UPDATE PLANS PER REGULATORY COMMENTS	RCK	JUM
2	12/27/2019	IN HOUSE REVISIONS	RCK	JUM
1	12/23/19	NO REVISIONS THIS SHEET	RCK	JUM

May 28, 2020 - 12:07pm F:\MISC Projects\47361 - Portsmouth\47361-00 - Green & Co - Banfield Road\Design\Production Drawings\Details.dwg

Copyright 2019 © Thomas F. Moran, Inc.
 48 Constitution Drive, Bedford, N.H. 03110

All rights reserved. These plans and materials may not be copied, duplicated, replicated or otherwise reproduced in any form whatsoever without the prior written permission of Thomas F. Moran, Inc.

This plan is not effective unless signed by a duly authorized officer of Thomas F. Moran, Inc.



TOTAL COVER: 18" MINIMUM AND 120" MAXIMUM. FIRST 12" MUST BE FREE DRAINING BACKFILL (SPEC SECTION 2.03B). STONE <1.5" OR SOIL (USCS CLASS GW, GP, SW OR SP). ADDITIONAL FILL MAY BE STRUCTURAL FILL (SPEC SECTION 2.03C). STONE OR SOIL (USCS CLASS SM, SP, SW, GM, GP OR GW) WITH MAX CLAY CONTENT <10%, MAX 25% PASSING NO. 200 SIEVE, AND MAX PLASTICITY INDEX OF 4. A MIN. 12" COVER MUST BE MAINTAINED BETWEEN BACKFILL EQUIPMENT AND THE TOP OF THE R-TANK™ SYSTEM AT ALL TIMES. TOTAL HEIGHT OF TOP BACKFILL SHOULD NOT EXCEED 10'. CONTACT ACF ENVIRONMENTAL IF MORE THAN 10' OR LESS THAN 18" OF TOP BACKFILL IS REQUIRED (FROM TOP OF TANK TO TOP OF PAVEMENT).

- NOTES:
- FOR COMPLETE MODULE DATA, SEE APPROPRIATE R-TANK^{SD} MODULE SHEET.
 - INSTALLATIONS PER THIS DETAIL MEET GUIDELINES OF HL-93 LOADING PER THE AASHTO LRFD BRIDGE DESIGN SPECIFICATIONS, CUSTOMARY U.S. UNITS, 7TH EDITION, 2014 WITH 2015 AND 2016 INTERIM REVISIONS.
 - PRE-TREATMENT STRUCTURES NOT SHOWN.
 - FOR INFILTRATION APPLICATIONS, GEOTEXTILE ENVELOPING R-TANK SHALL BE ACF M200 (PER SPEC SECTION 2.02A) AND BASE SHALL BE 4" MIN. UNCOMPACTED FREE DRAINING BACKFILL (SPEC SECTION 2.03A) TO PROVIDE A LEVEL BASE. SURFACE MUST BE SMOOTH, FREE OF LUMPS OR DEBRIS, AND EXTEND 2' BEYOND R-TANK^{SD} FOOTPRINT.

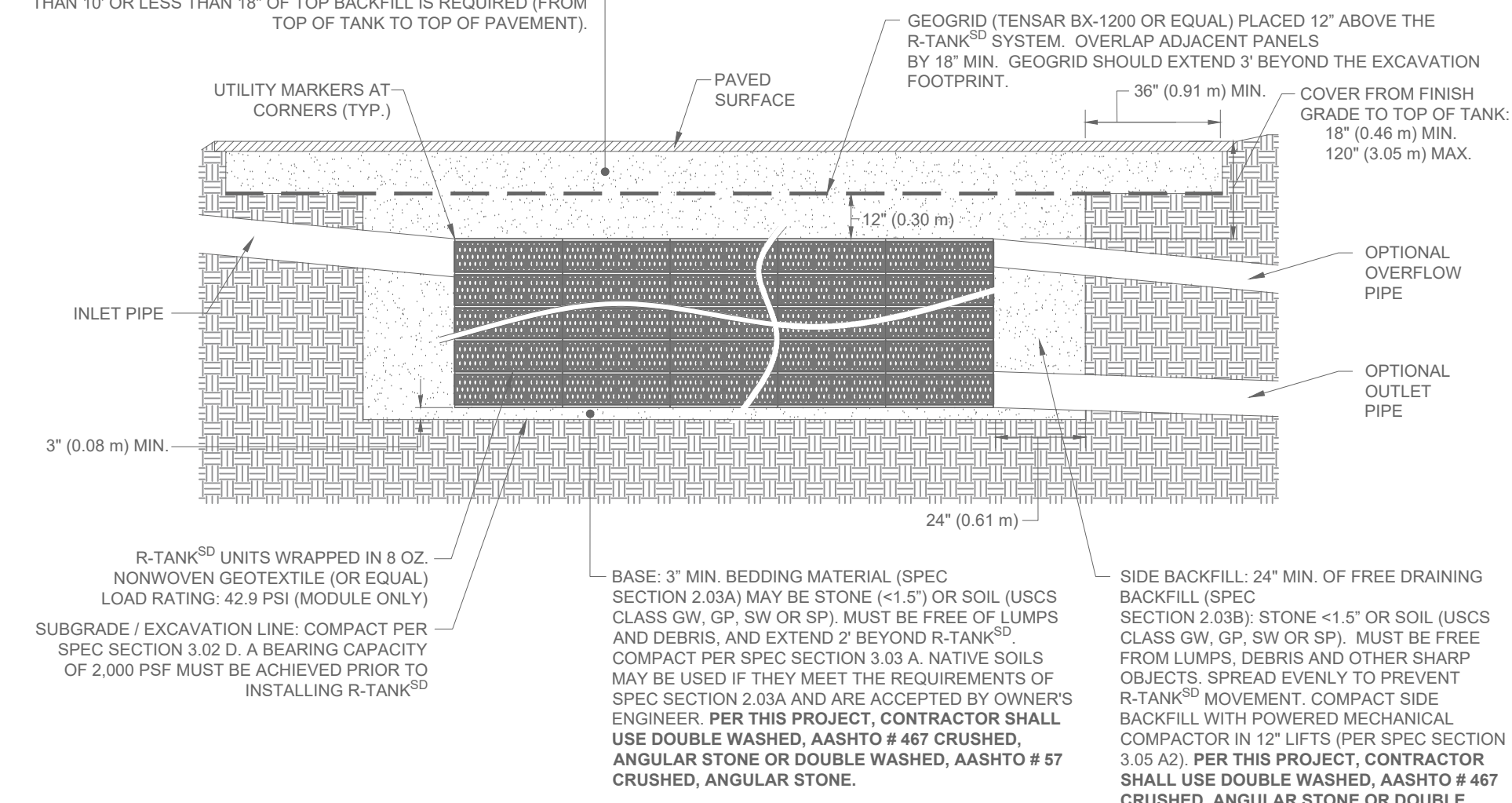

R-TANK^{SD} & HS-20 LOADS - SECTION VIEW

CUT A ROUND HOLE IN THE LINER ENVELOPE AND GEOTEXTILE PROTECTION FABRIC THAT IS SLIGHTLY LARGER THAN THE PIPE.

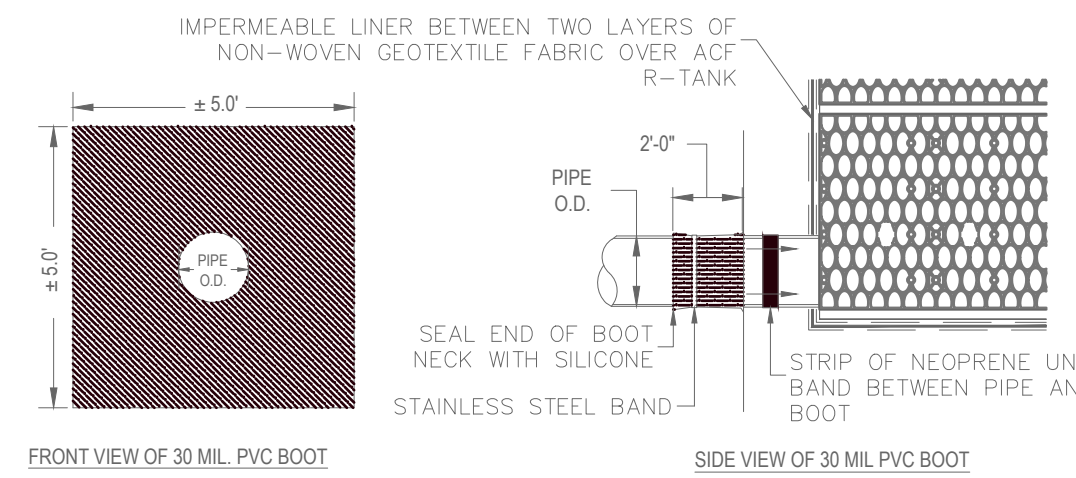
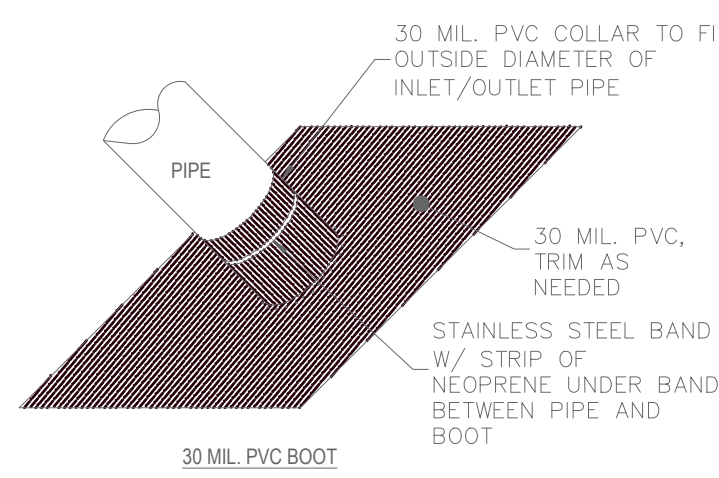
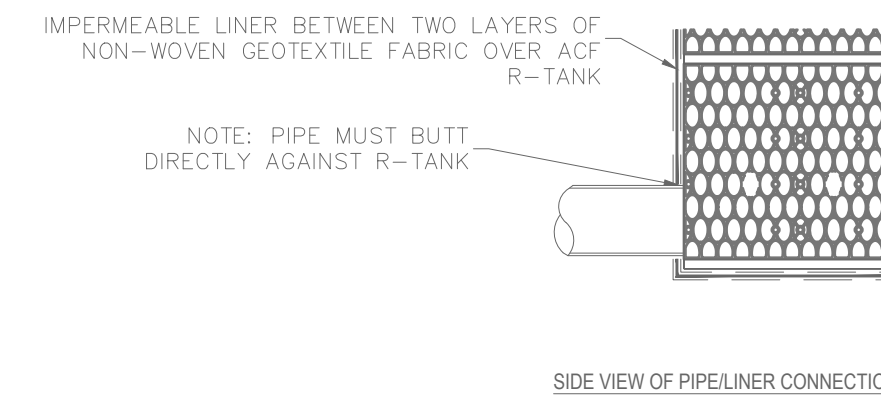
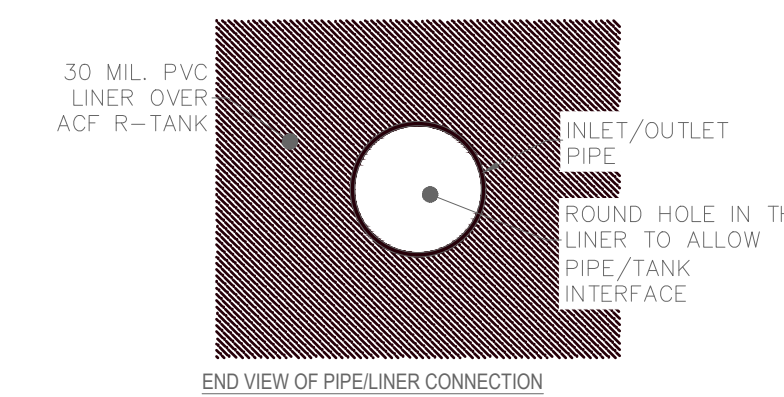

AFTER LINER IS CUT AND PIPE INSTALLED, SLIDE BOOT AGAINST TANK AND SECURE WITH STAINLESS STEEL BAND. THEN BOND BOOT TO TANK LINER AND SEAL END OF BOOT WITH SILICONE. REPLACE ANY GEOTEXTILE PROTECTION FABRIC REMOVED DURING BOOT INSTALLATION PROCESS.

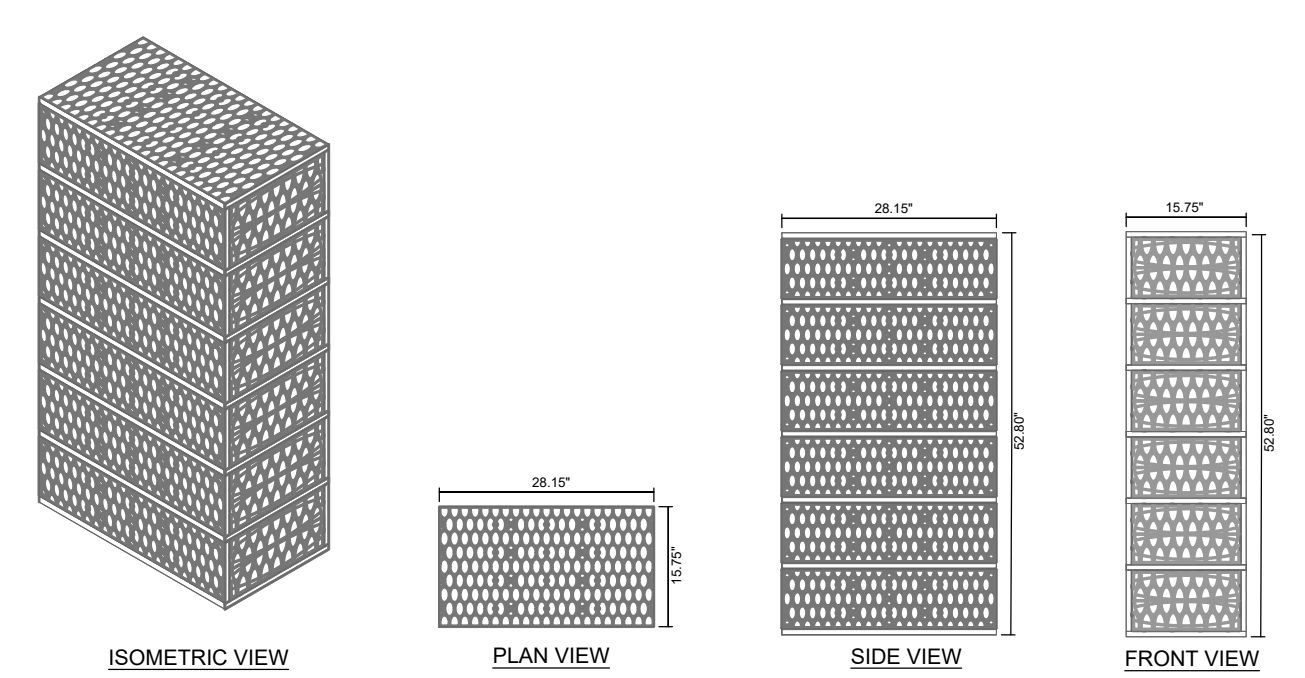

MODULE DATA

GEOMETRY: LENGTH = 28.15 IN. (715 MM) WIDTH = 15.75 IN. (400 MM) HEIGHT = 52.80 IN. TANK VOLUME = 13.52 CF STORAGE VOLUME = 12.84 CF VOID INTERNAL VOLUME: 95% VOID SURFACE AREA: 90%	LOAD RATING: 42.9 PSI, (MODULE ONLY) HS25, (WITH ACF COVER SYSTEM)	MATERIAL: 100% RECYCLED POLYPROPYLENE
SMALL PLATES PER SEGMENT/TOTAL: 5/30		

R-TANK^{SD} - HEX MODULE

R-TANK TYPICAL INLET/OUTLET W/ 30 MIL PVC BOOT

- NOTES
- THIS PORT IS USED TO PUMP WATER INTO THE SYSTEM AND RE-SUSPEND ACCUMULATED SEDIMENT SO THAT IT MAY BE PUMPED OUT.
 - MINIMUM REQUIRED MAINTENANCE INCLUDES A QUARTERLY INSPECTION DURING THE FIRST YEAR OF OPERATION AND A YEARLY INSPECTION THEREAFTER, FLUSH AS NEEDED.
 - ONLY R-TANK^{SD} AND R-TANK^{HD} MAY BE USED IN TRAFFIC APPLICATIONS.

DEPTH SUMMARY

TYPE	A	B
R-TANK ^{SD}	12" MIN - 36" MAX	AS SHOWN ON PLANS
R-TANK ^{HD}	20" MIN - 6.99" MAX	12"
R-TANK ^{SD}	18" MIN - 9.99" MAX	12"

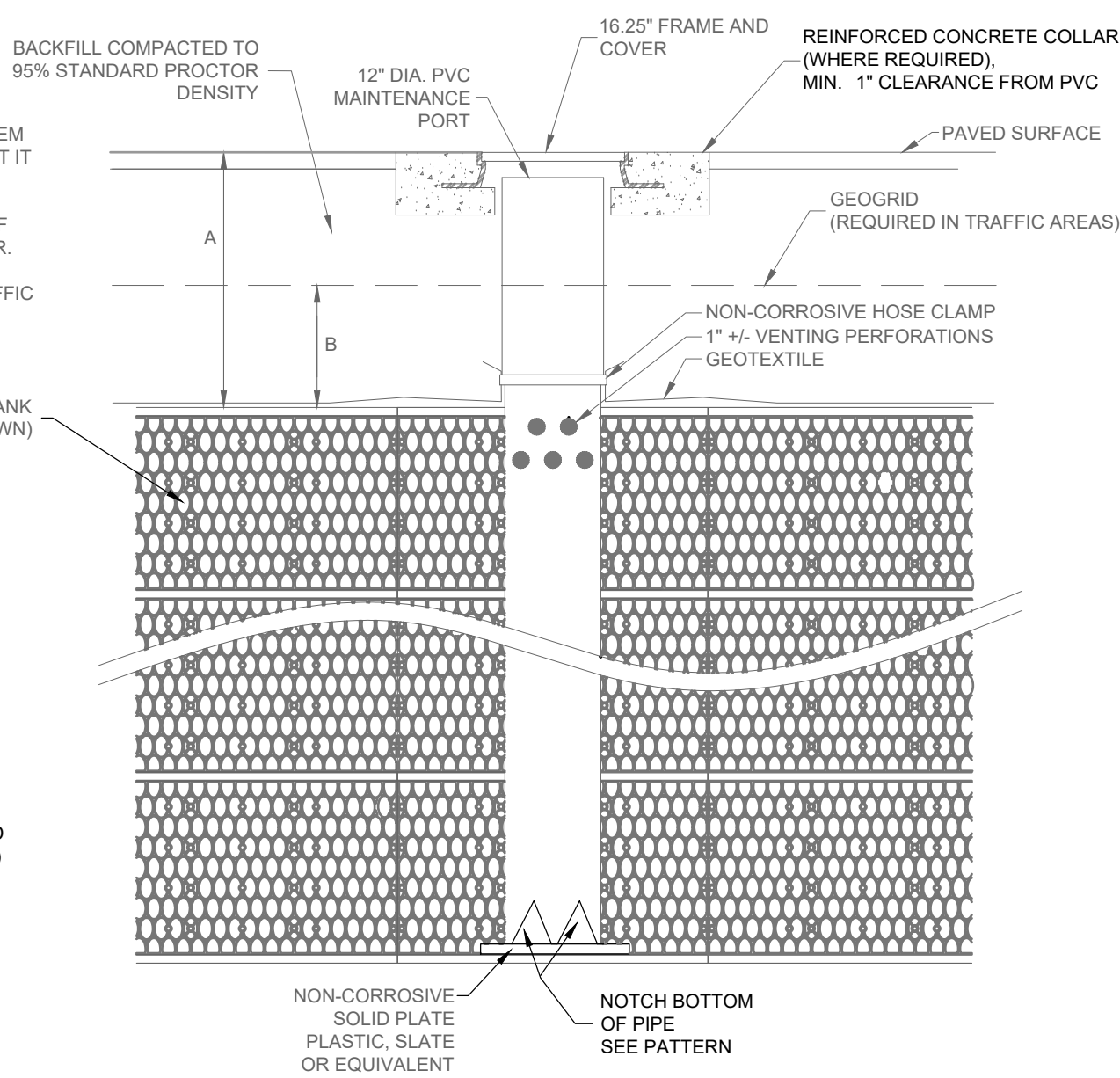
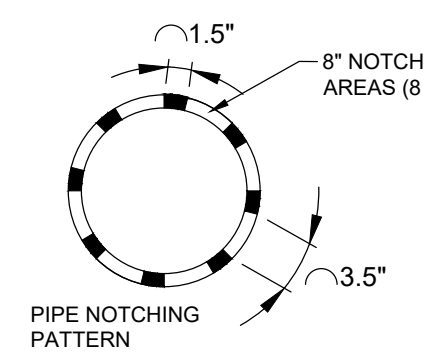

MAINTENANCE PORT FOR R-TANK^{SD}, R-TANK^{HD}, AND R-TANK^{SD}

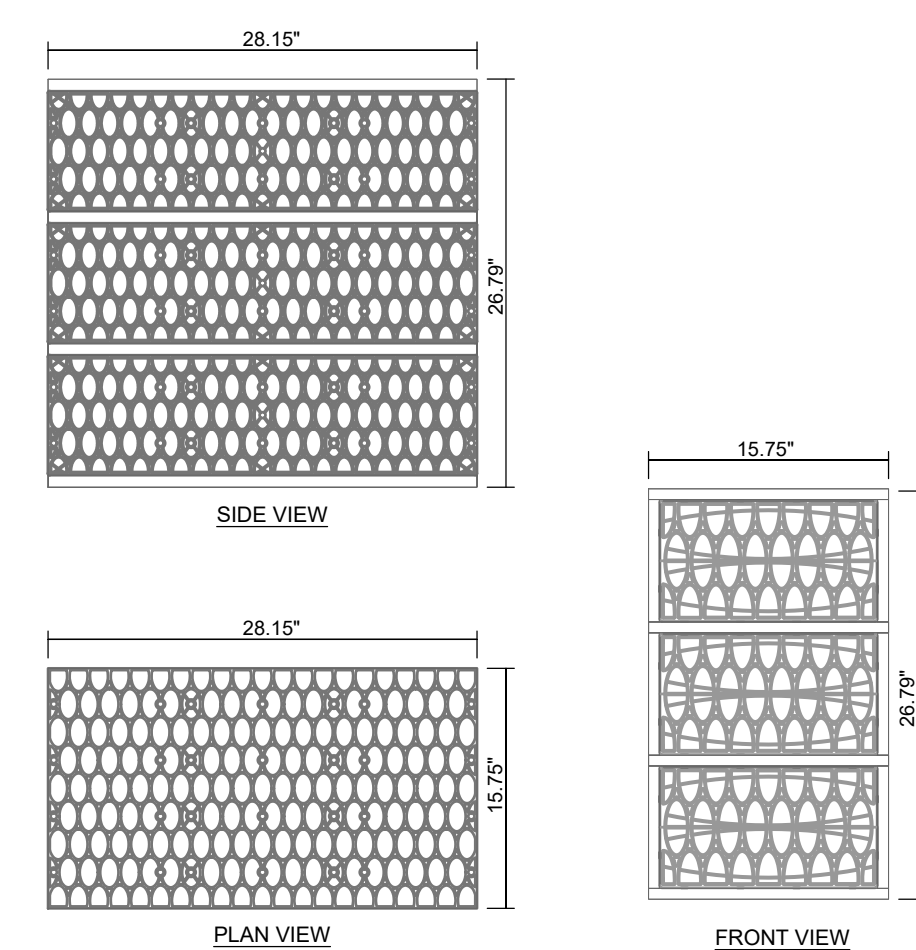
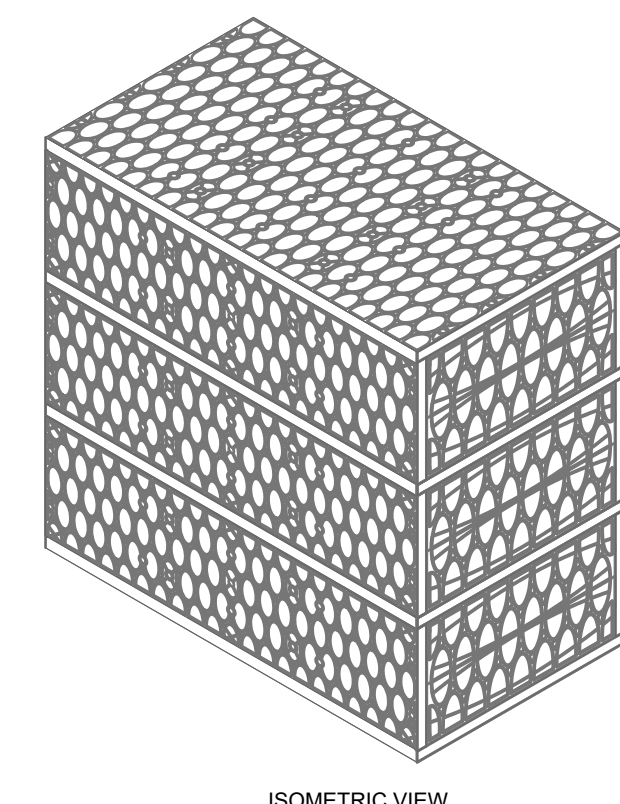

MODULE DATA

GEOMETRY: LENGTH = 28.15 IN. (715 MM) WIDTH = 15.75 IN. (400 MM) HEIGHT = 26.79 IN. TANK VOLUME = 6.86 CF STORAGE VOLUME = 6.52 CF VOID INTERNAL VOLUME: 95% VOID SURFACE AREA: 90%	LOAD RATING: 42.9 PSI, (MODULE ONLY) HS25, (WITH ACF COVER SYSTEM)	MATERIAL: 100% RECYCLED POLYPROPYLENE
SMALL PLATES PER SEGMENT/TOTAL: 5/15		

R-TANK^{SD} - TRIPLE MODULE

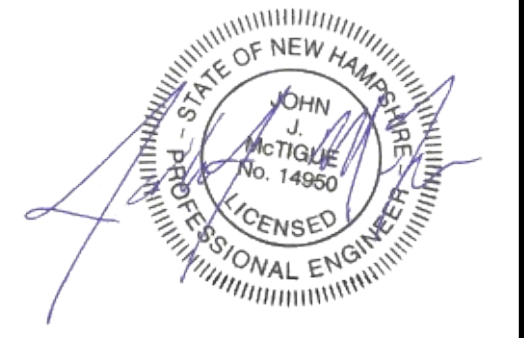

SITE DEVELOPMENT PLANS
TAX MAP 256 LOT 2
DETAILS
THE VILLAGE AT BANFIELD WOODS
PORTSMOUTH, NH
OWNED BY
WALTER D HETT TRUST
PREPARED FOR
GREEN & COMPANY REAL ESTATE

SCALE: SEPTEMBER 25, 2019

May 28, 2020 - 12:07pm F:\MSC Projects\47361 - Portsmouth\47361-00 - Green & Co - Banfield Road\Design\Production Drawings\Details.dwg

Copyright 2019 © Thomas F. Moran, Inc.
48 Constitution Drive, Bedford, N.H. 03110
All rights reserved. These plans and materials may not be copied, duplicated, replicated or otherwise reproduced in any form whatsoever without the prior written permission of Thomas F. Moran, Inc.
This plan is not effective unless signed by a duly authorized officer of Thomas F. Moran, Inc.



REV	DATE	DESCRIPTION	DR	CK
6	5/5/2020	AoT SUBMITTAL	RCK	JJM
5	4/29/2020	REVISOR PER REGULATORY COMMENTS	RCK	JJM
4	3/20/2020	PROGRESS PRINT	RCK	JJM
3	3/4/2020	UPDATE PLANS PER REGULATORY COMMENTS	RCK	JJM
2	12/27/2019	IN HOUSE REVISIONS	RCK	JJM
1	12/23/19	NO REVISIONS THIS SHEET	RCK	JJM

TFM Civil Engineers
Structural Engineers
Traffic Engineers
Land Surveyors
Landscape Architects
Scientists

48 Constitution Drive
Bedford, NH 03110
Phone (603) 472-4488
Fax (603) 472-9747
www.tfmoran.com

47361.00 DR RCK FB
CK JJM CADFILE
DETAILS

C-38

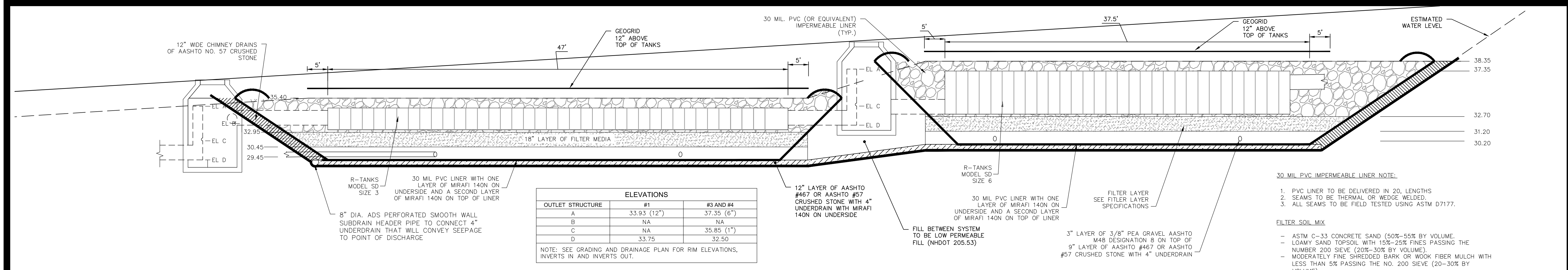

ELEVATIONS		
OUTLET STRUCTURE	#1	#3 AND #4
A	33.93 (12")	37.35 (6")
B	NA	NA
C	NA	35.85 (1")
D	33.75	32.50

NOTE: SEE GRADING AND DRAINAGE PLAN FOR RIM ELEVATIONS, INVERTS IN AND INVERTS OUT.

R-TANKS - PROFILE VIEW
NOT TO SCALE

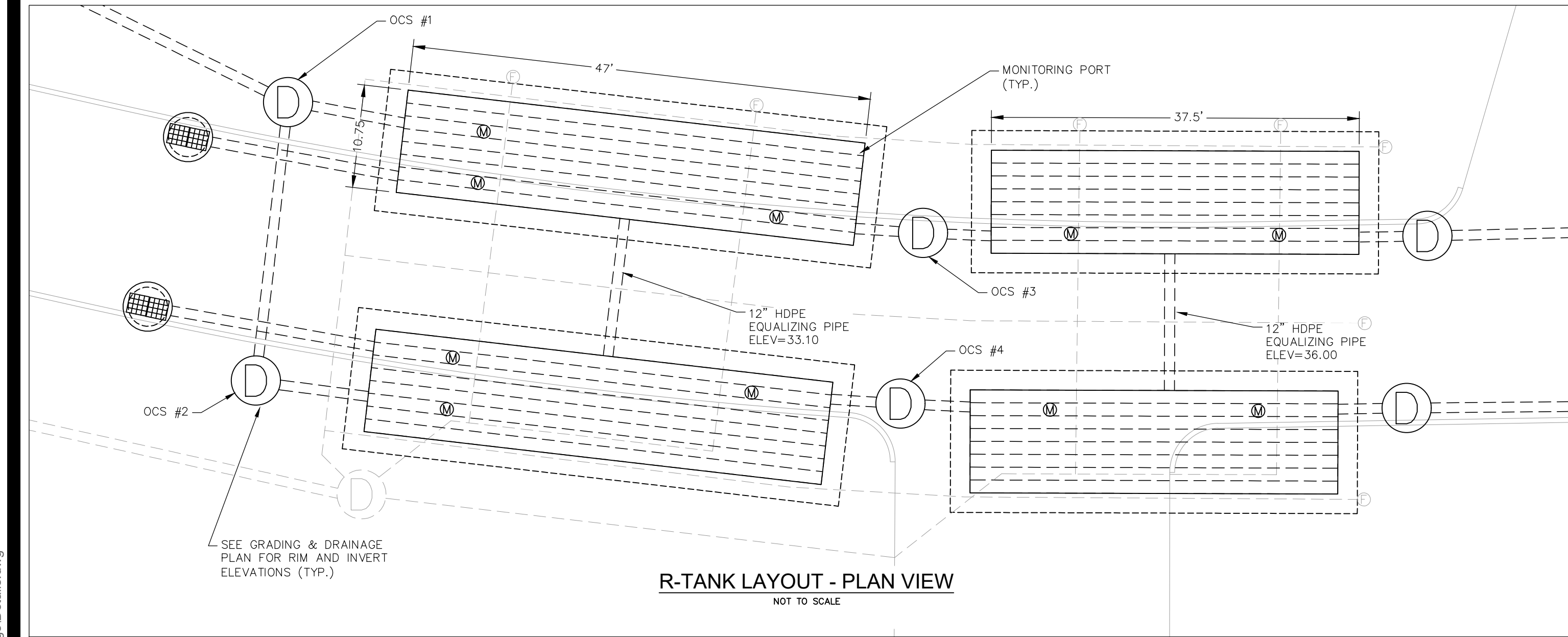

R-TANK LAYOUT - PLAN VIEW
NOT TO SCALE

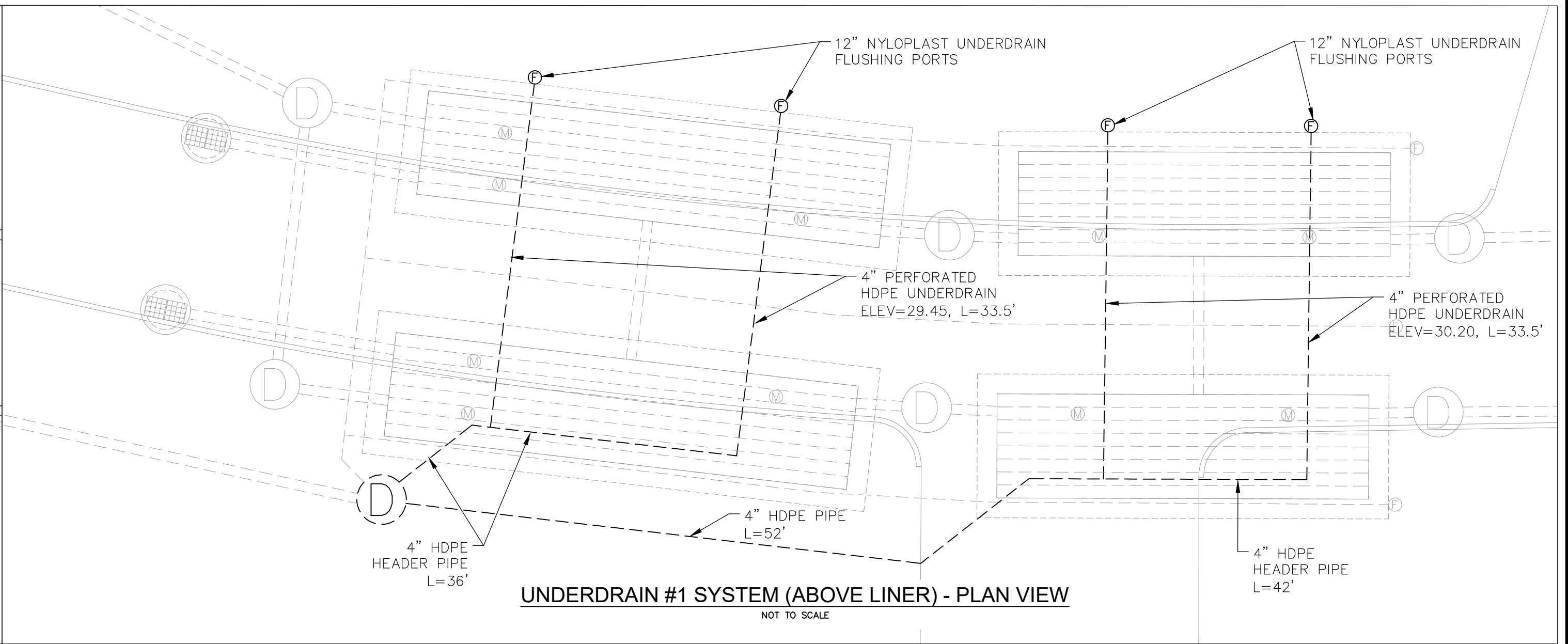

UNDERDRAIN #1 SYSTEM (ABOVE LINER) - PLAN VIEW
NOT TO SCALE

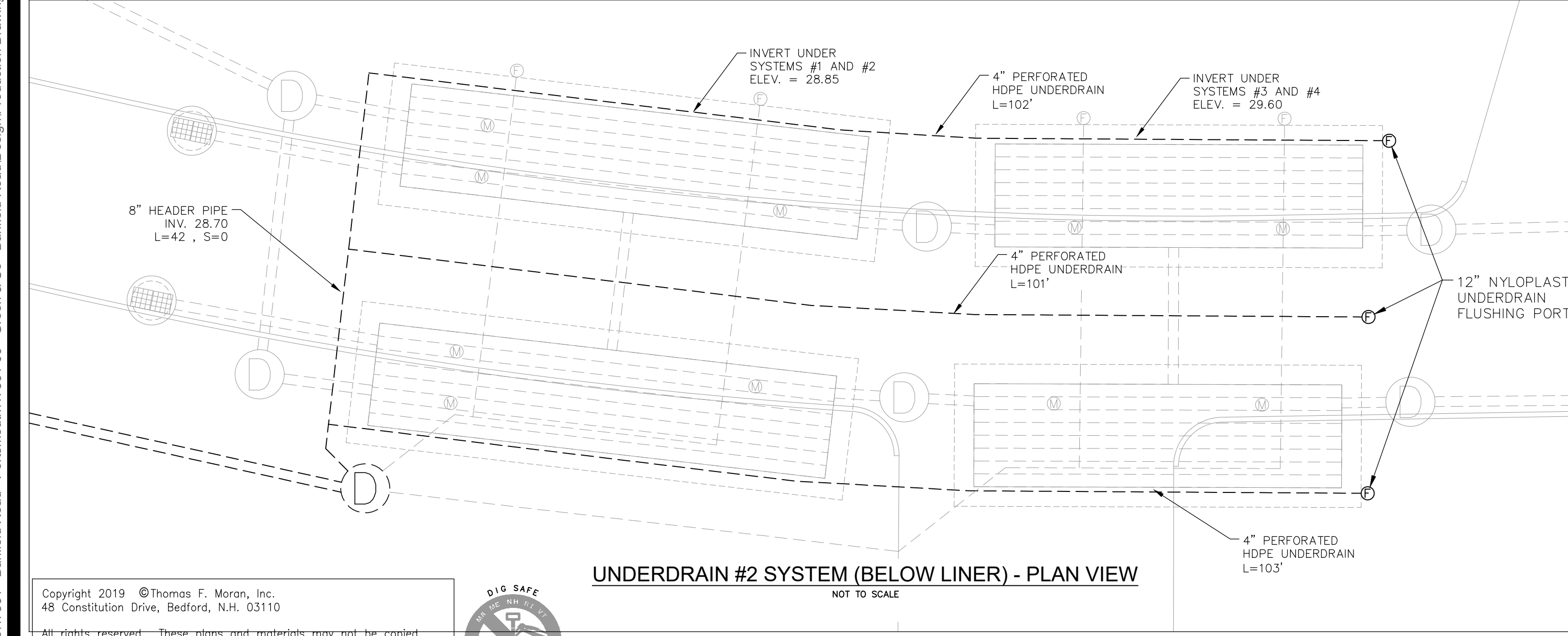

UNDERDRAIN #2 SYSTEM (BELOW LINER) - PLAN VIEW
NOT TO SCALE

NOTE:
1. ALL UNDERDRAIN TO BE INSTALLED WITH ONE HOLE FACING UPWARD AND TWO HOLE FACING DOWNWARD.

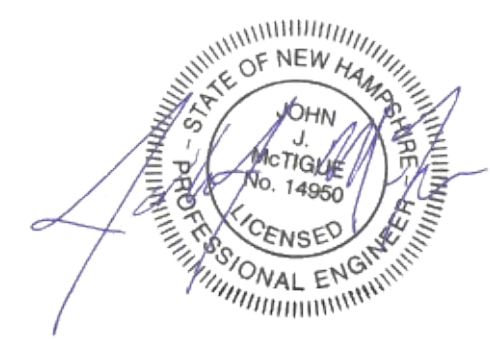

SITE DEVELOPMENT PLANS
TAX MAP 256 LOT 2
DETAILS
THE VILLAGE AT BANFIELD WOODS
PORTSMOUTH, NH
OWNED BY
WALTER D HETT TRUST
PREPARED FOR
GREEN & COMPANY REAL ESTATE

SCALE: **SEPTEMBER 25, 2019**

ACF R-TANKS - SD MODEL - SIZE 3 & 6

REV	DATE	DESCRIPTION	DR	CK
6	5/5/2020	AoT SUBMITTAL	RCK	JJM
5	4/29/2020	REVISOR PER REGULATORY COMMENTS	RCK	JJM
4	3/20/2020	PROGRESS PRINT	RCK	JJM
3	3/4/2020	UPDATE PLANS PER REGULATORY COMMENTS	RCK	JJM
2	12/27/2019	IN HOUSE REVISIONS	RCK	JJM
1	12/23/19	NO REVISIONS THIS SHEET	RCK	JJM

TFM Civil Engineers
Structural Engineers
Traffic Engineers
Land Surveyors
Landscape Architects
Scientists

48 Constitution Drive
Bedford, NH 03110
Phone (603) 472-4488
Fax (603) 472-9747
www.tfmoran.com

47361.00 DR RCK FB
CK JUM CADFILE
DETAILS C-39

May 28, 2020 - 5:14pm F:\MSC Projects\47361 - Portsmouth\47361-00 - Green & Co - Banfield Road\Design\Production Drawings\Details.dwg

Copyright 2019 © Thomas F. Moran, Inc.
48 Constitution Drive, Bedford, N.H. 03110
All rights reserved. These plans and materials may not be copied, duplicated, replicated or otherwise reproduced in any form whatsoever without the prior written permission of Thomas F. Moran, Inc.
This plan is not effective unless signed by a duly authorized officer of Thomas F. Moran, Inc.



May 28, 2020 - 12:07pm F:\MSC Projects\47361 - Portsmouth - Banfield Road - Portsmouth\47361-00 - Green & Co - Banfield Road\Design\Production Drawings\Details.dwg

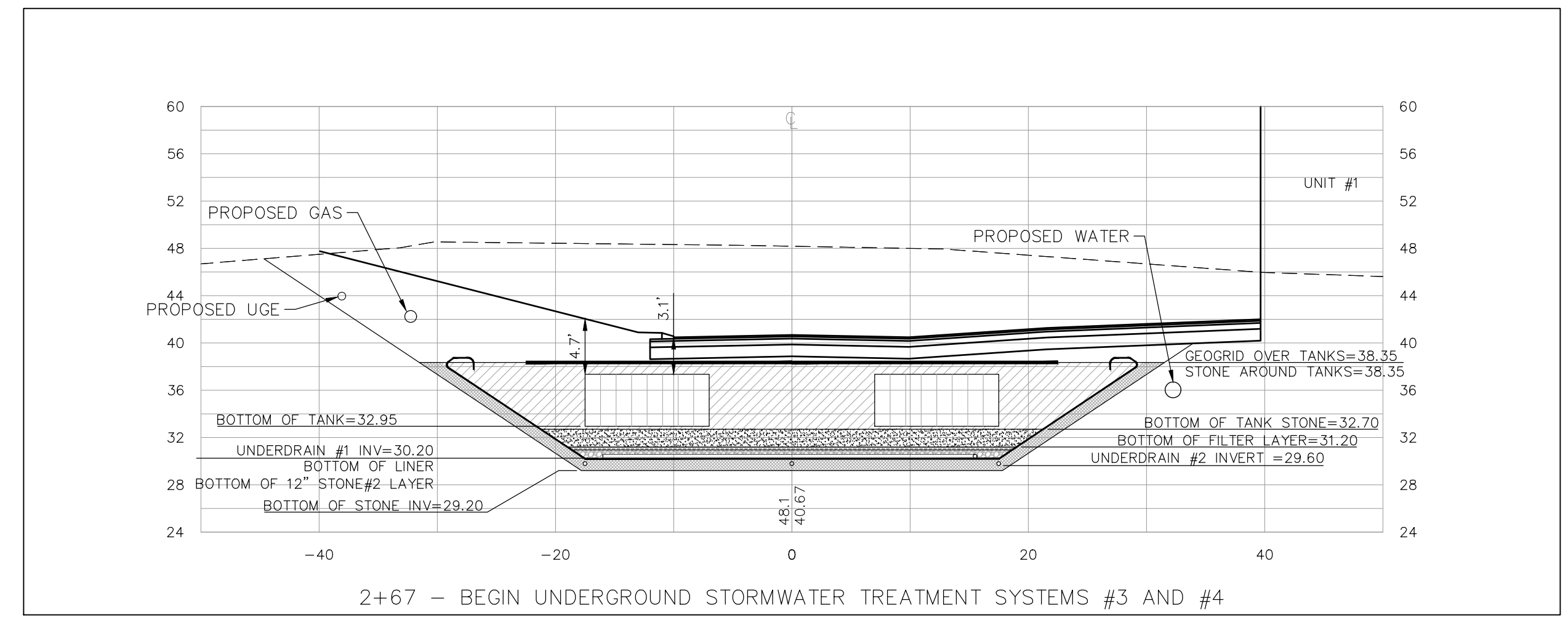
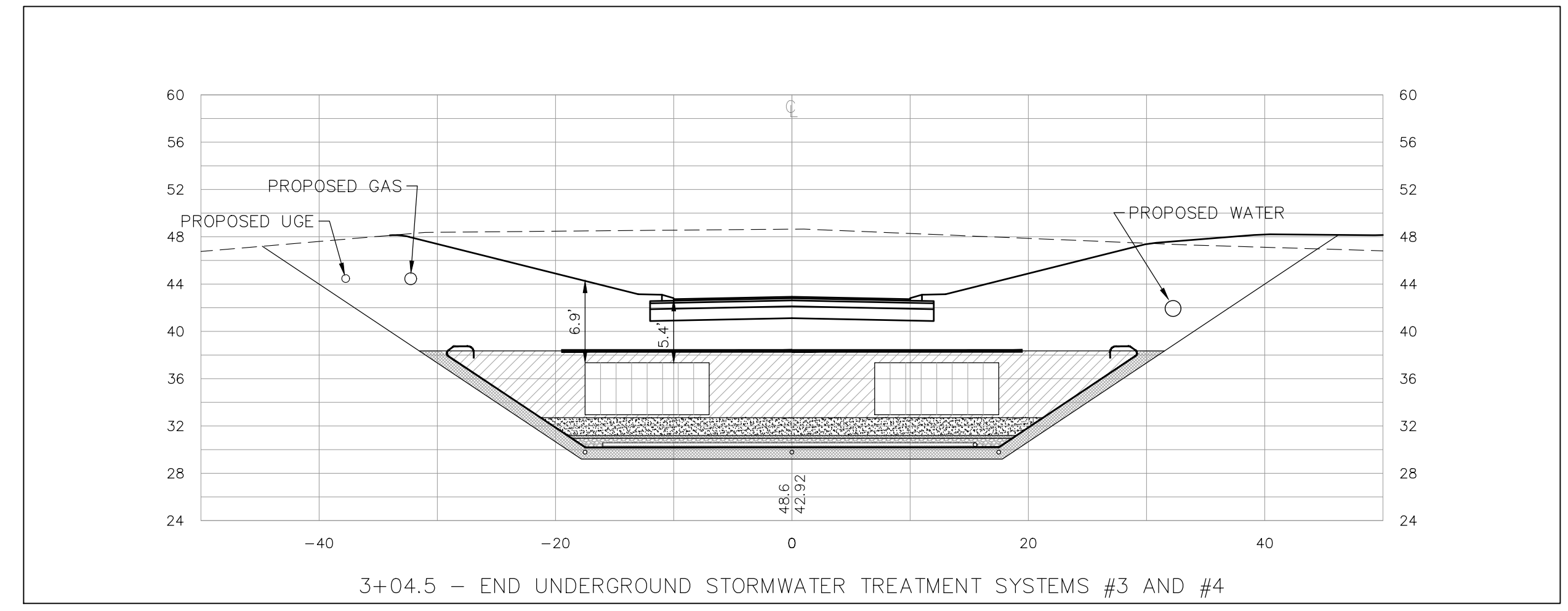
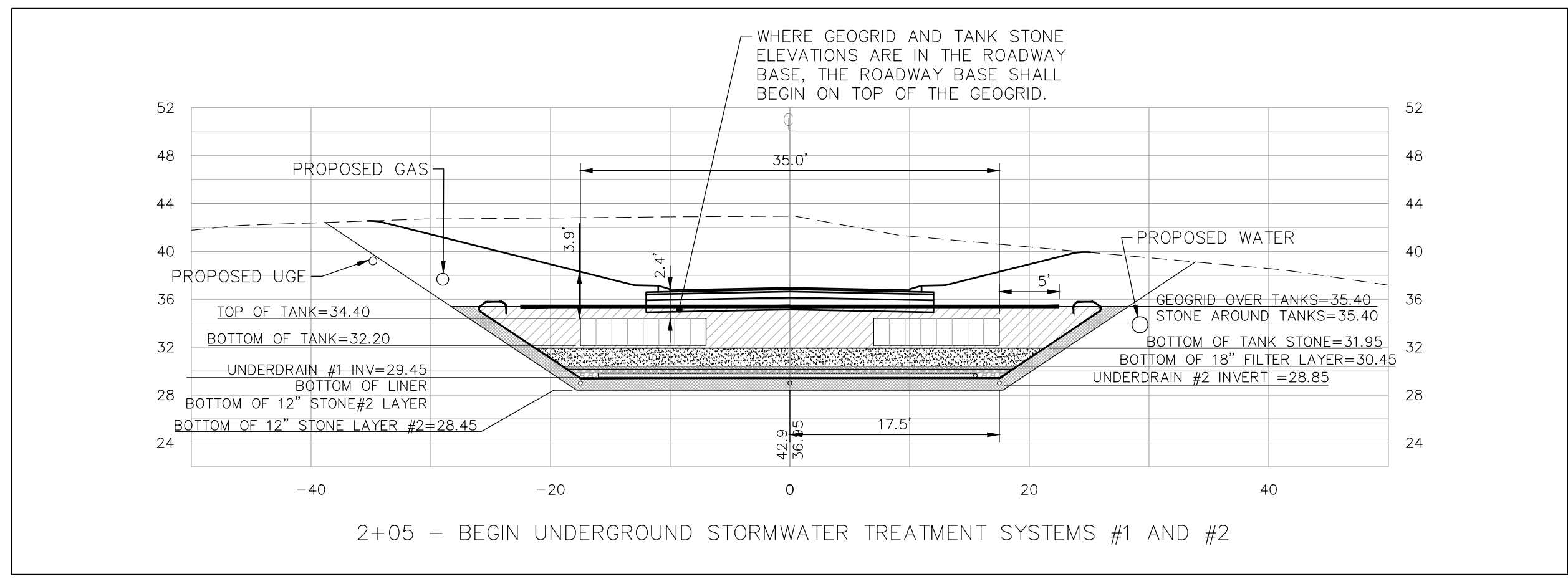
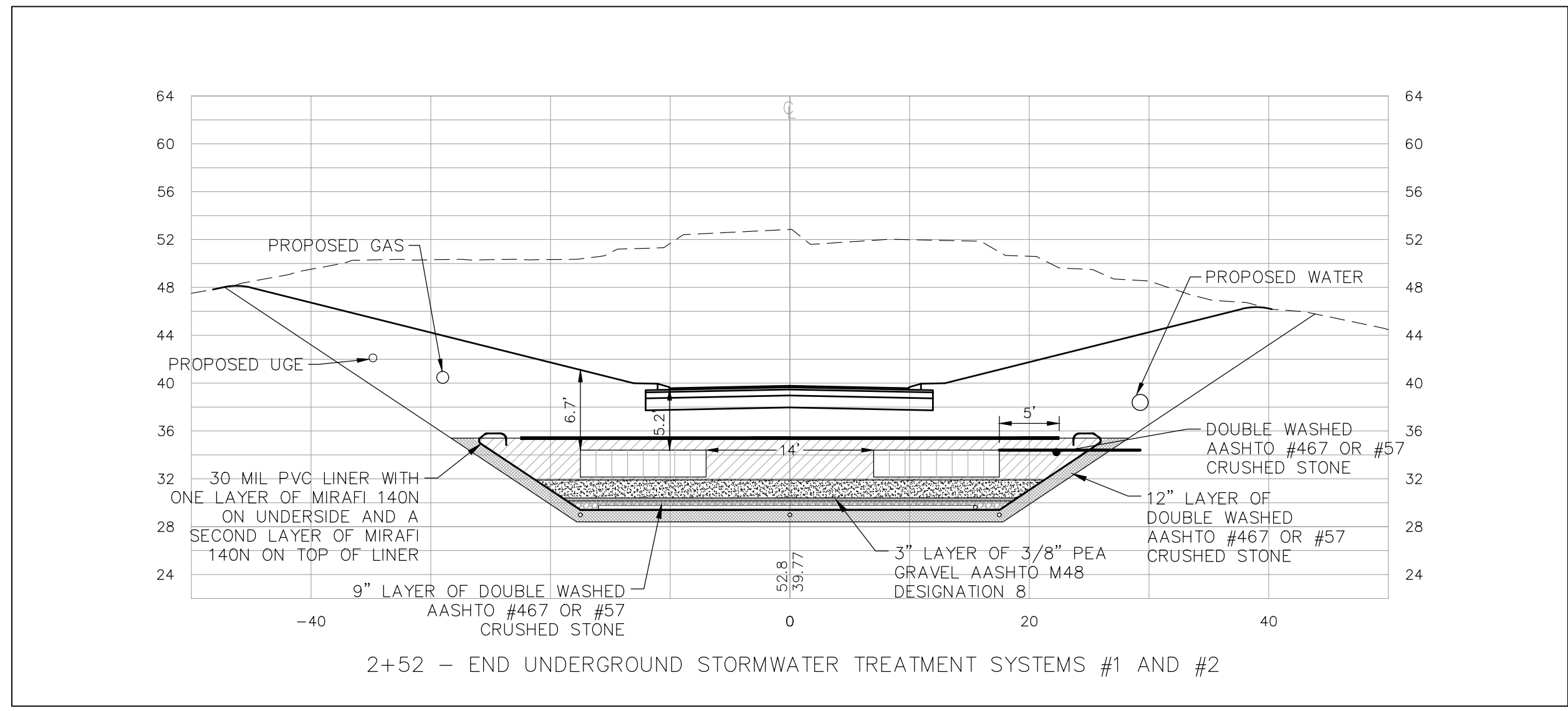

Copyright 2019 © Thomas F. Moran, Inc.
 48 Constitution Drive, Bedford, N.H. 03110
 All rights reserved. These plans and materials may not be copied, duplicated, replicated or otherwise reproduced in any form whatsoever without the prior written permission of Thomas F. Moran, Inc.
 This plan is not effective unless signed by a duly authorized officer of Thomas F. Moran, Inc.

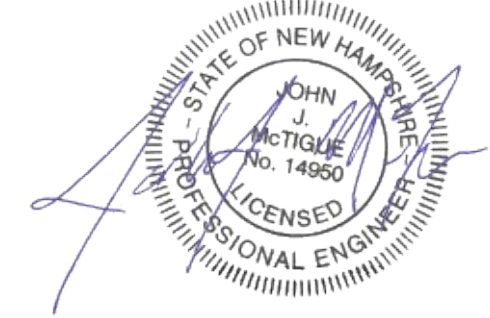

SITE DEVELOPMENT PLANS
 TAX MAP 256 LOT 2
DETAILS
THE VILLAGE AT BANFIELD WOODS
PORTSMOUTH, NH
 OWNED BY
WALTER D HETT TRUST
 PREPARED FOR
GREEN & COMPANY REAL ESTATE

SCALE: _____ **SEPTEMBER 25, 2019**

REV	DATE	DESCRIPTION	DR	CK
6	5/5/2020	AoT SUBMITTAL	RCK	JJM
5	4/29/2020	REVISOR PER REGULATORY COMMENTS	RCK	JJM
4	3/20/2020	PROGRESS PRINT	RCK	JJM
3	3/4/2020	UPDATE PLANS PER REGULATORY COMMENTS	RCK	JJM
2	12/27/2019	IN HOUSE REVISIONS	RCK	JJM
1	12/23/19	NO REVISIONS THIS SHEET	RCK	JJM

TFM Civil Engineers
 Structural Engineers
 Traffic Engineers
 Land Surveyors
 Landscape Architects
 Scientists

48 Constitution Drive
 Bedford, NH 03110
 Phone (603) 472-4488
 Fax (603) 472-9747
 www.tfmoran.com

47361.00 DR RCK FB
 CK JJM CADFILE
 DETAILS C-40

SEQUENCE OF CONSTRUCTION FOR R-TANKS

- PHASE 1 TEMPORARY EXCAVATION: AFTER SITE PREPARATION HAS BEEN COMPLETED, EXCAVATE TO APPROXIMATELY TWO FEET ABOVE THE TOP OF THE PROPOSED R-TANKS, FULL WIDTH TO THE LIMIT OF THE 1.5:1 CUTS FOR THE PROPOSED R-TANK AREA, FROM STATION 1+50 TO STATION 3+50.
- PHASE 2 EXCAVATION OF WORK AREA #1: PRIOR TO THE NEXT PHASE OF EXCAVATION, INSTALL FES #1 WITH 12" HDPE TO MH-01. BEGIN EXCAVATION AT THE DOWN-HILL STATION LIMITS OF SYSTEM #2 AND PROGRESS UP TO THE UPPER LIMITS OF SYSTEM #4. LEAVE A 16' PLATFORM FOR SITE ACCESS ON THE LEFT OF THE EXCAVATION WITH 1.5:1 SLOPES TO THE BOTTOM OF THE PROPOSED EXCAVATION. EXCAVATE TO THE FULL DEPTH OF THE PROPOSED EXCAVATION.
 - MAINTAIN A 16' ACCESS ON THE PHASE 1 SUBGRADE LEFT OF CENTERLINE.
 - AT THE BEGINNING OF THE EXCAVATION, INSTALL THE PROPOSED 6" HEADER PIPE FROM MH-01 INTO THE EXCAVATION. PROTECT THE INLET WITH FABRIC AND STONE DURING THE EXCAVATION PROCESS.
- PHASE 3 INSTALLATION IN WORK AREA #1: CONSTRUCT SYSTEMS #2 AND #4 LAYERS. INSTALLATION CREW WILL BUILD THE SELECT LAYERS AND R-TANKS FROM SITTING ON THE PHASE 2 SUB-GRADE. THE COMPLETE SECTION WILL BE BUILT FROM THE START OF SYSTEM #2 AT STATION 2+05 AND WORK IN 20 FOOT INCREMENTS TOWARD THE END OF SYSTEM #4 AT STATION 3+04.5. THE PVC LINER WILL BE FACTORY CUT TO FORM TO THE 1.5:1 SLOPES IN THE 20 FOOT SECTIONS. THE SEAMS WILL FIELD WELDED WITH A ONE FOOT OVER-LAP.
 - ON THE LEFT SIDE OF THE INSTALLATION, THE LIMITS OF WORK FOR THE WILL BE DETERMINED BY A 1.5:1 SLOPE, FROM THE CENTERLINE OF THE ROADWAY UP TO THE TOP OF THE INSTALLATION.
 - THE R-TANKS WILL BE INSTALLED FOR THE FULL WIDTH.
 - THE GEO-GRID WILL BE LEFT FULL LENGTH, DRAPED OVER THE TANK FOR THE NEXT PHASE OF CONSTRUCTION.
 - PVC LINER WILL BE FABRICATED WITH ON ONE FOOT OVERLAY AT THE CENTER OF THE ROADWAY.
 - A 16' WIDE, 12" OF CRUSHED STONE (NHDOT 304.4) WILL BE CREATED OVER THE TOP OF THE GEO-GRID AND TANK STONE AND TO THE RIGHT OF F SYSTEM #2 AND #4 R-TANK INSTALLATIONS TO ALLOW FOR 24" COVER ABOVE AND TO THE RIGHT OF THE R-TANKS. THIS WILL ALLOW ACCESS TO THE SITE WHILE THE NEXT PHASE IS CONSTRUCTED.
- PHASE 4 EXCAVATION OF WORK AREA #2: BEGIN EXCAVATION AT THE DOWN-STATION LIMITS OF SYSTEM #1 AND PROGRESS TO THE UP-STATION LIMIT OF SYSTEM #3. AT THE START OF THE EXCAVATION EXTEND THE PROPOSED 8" HDPE UNDER-DRAIN HEADER PIPE FROM SYSTEM #2 INTO THE PHASE 4 EXCAVATION AREA. PROTECT THE INLET WITH FABRIC AND STONE DURING THE EXCAVATION PROCESS.
 - MAINTAIN THE 16' ACCESS WAY ON THE RIGHT SYSTEMS #2 AND #4 THAT WAS CREATED IN PHASE 3.
- PHASE 5 INSTALLATION IN WORK AREA #2: INSTALLATION CREW WILL BUILD THE SELECT LAYERS AND R-TANKS FROM SITTING ON THE PHASE 4 SUB-GRADE. THE COMPLETE SECTION WILL BE BUILT FROM THE START OF SYSTEM #1 AT STATION 2+05 AND WORK IN 20 FOOT INCREMENTS TOWARD THE END OF SYSTEM #3 AT STATION 3+04.5. THE PVC LINER WILL BE FACTORY CUT TO FORM TO THE 1.5:1 SLOPES IN THE 20 FOOT SECTIONS. THE SEAMS WILL FIELD WELDED WITH A ONE FOOT OVER-LAP.
 - A 12" OF CRUSHED STONE (NHDOT 304.4) WILL BE CREATED OVER THE TOP OF THE GEO-GRID AND TANK STONE TO ALLOW FOR 24" COVER ABOVE THE R-TANKS TO ALLOW ACCESS TO THE SITE.
 - ACCESS WAYS TO BE LIMITED TO THE 16' ACCESS WAY TO THE RIGHT OF SYSTEM #2 AND #4 AND TO THE LEFT OF SYSTEMS #1 AND 3.
- PHASE 6 CONSTRUCTION OF ROADWAY - PRIOR TO ROADWAY CONSTRUCTION, INSTALL UNDERGROUND CONDUITS, GAS AND WATER IN THIS PHASE. KEEP UTILITIES OUTSIDE OF LINER LIMIT AND BELOW ROADWAY SHOULDER ELEVATION TO ALLOW FOR FUTURE LANE SHIFTS IF REQUIRED FOR MAINTENANCE. COMPLETE ROADWAY SECTIONAL TO TOP OF CRUSHED GRAVEL FROM STATION 1+50 TO 3+50. FILL WITH APPROVED GRANULAR MATERIAL FROM EDGE OF ROADWAY SHOULDER TO INTERSECTION WITH THE TEMPORARY 1.5:1 SLOPES EXCAVATED IN PHASE 1. MAINTAIN 2% CROSS SLOPE ON CRUSHED GRAVEL THROUGH THE FILL AREA.
 - INSTALL 8" WATER UNDER THIS PHASE. KEEP UTILITIES OUTSIDE OF LINER LIMIT AND BELOW ROADWAY SHOULDER ELEVATION TO ALLOW FOR FUTURE LANE SHIFTS IF REQUIRED FOR MAINTENANCE.
- PHASE 7 CONSTRUCTION OF SIDE SLOPES: COMPLETE FINAL SLOPE GRADING AND BINDER PAVEMENT. ALL SLOPES TO BE LOAMED AND SEEDED. REFER TO LANDSCAPING PLANS FOR MORE DETAIL ON SEEDING AND PLANTINGS.

NOTE: CONSTRUCTION SEQUENCE FOR THE R-TANKS WAS CREATED IN CONSULTATION WITH SEVERINO TRUCKING CO., INC.

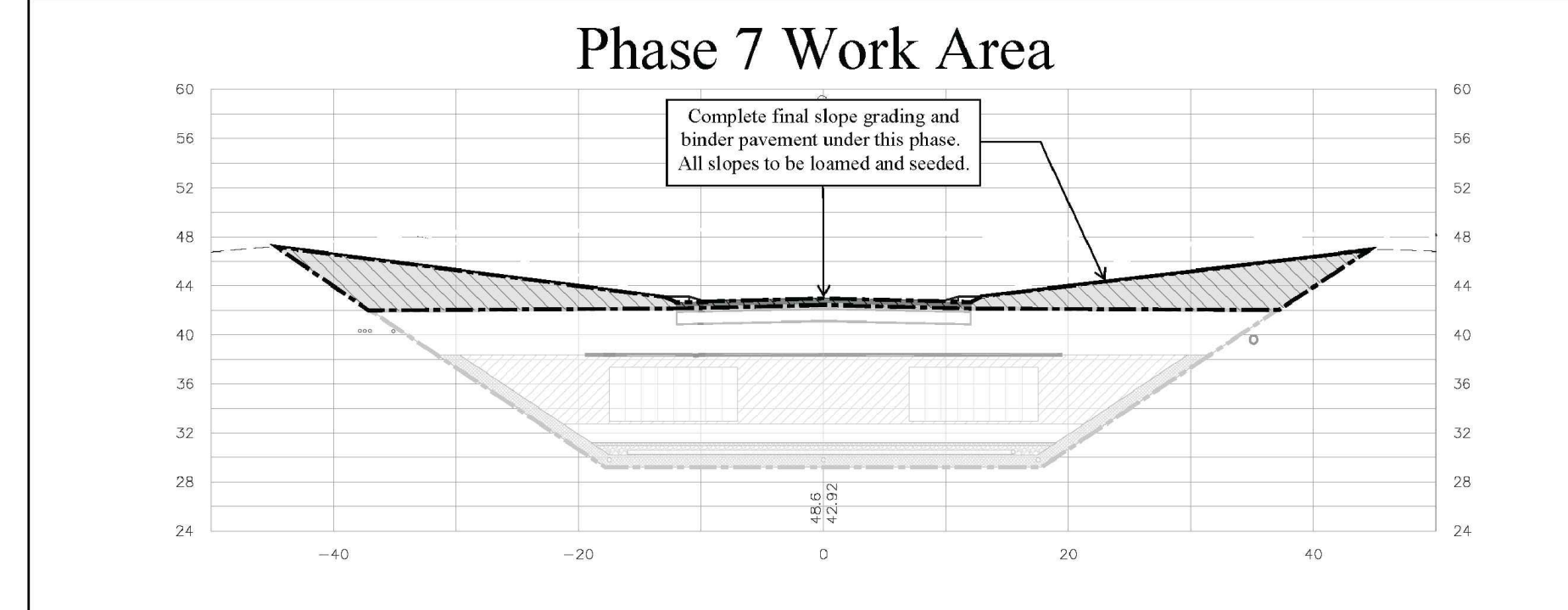
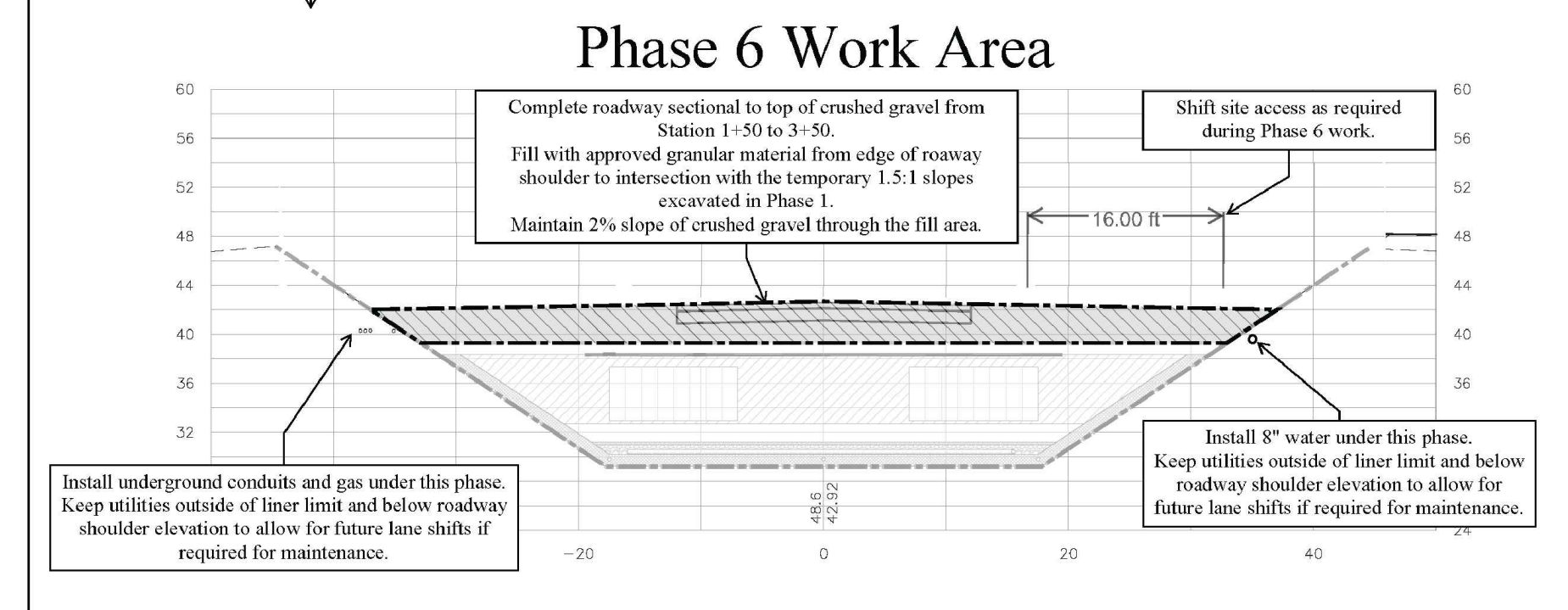
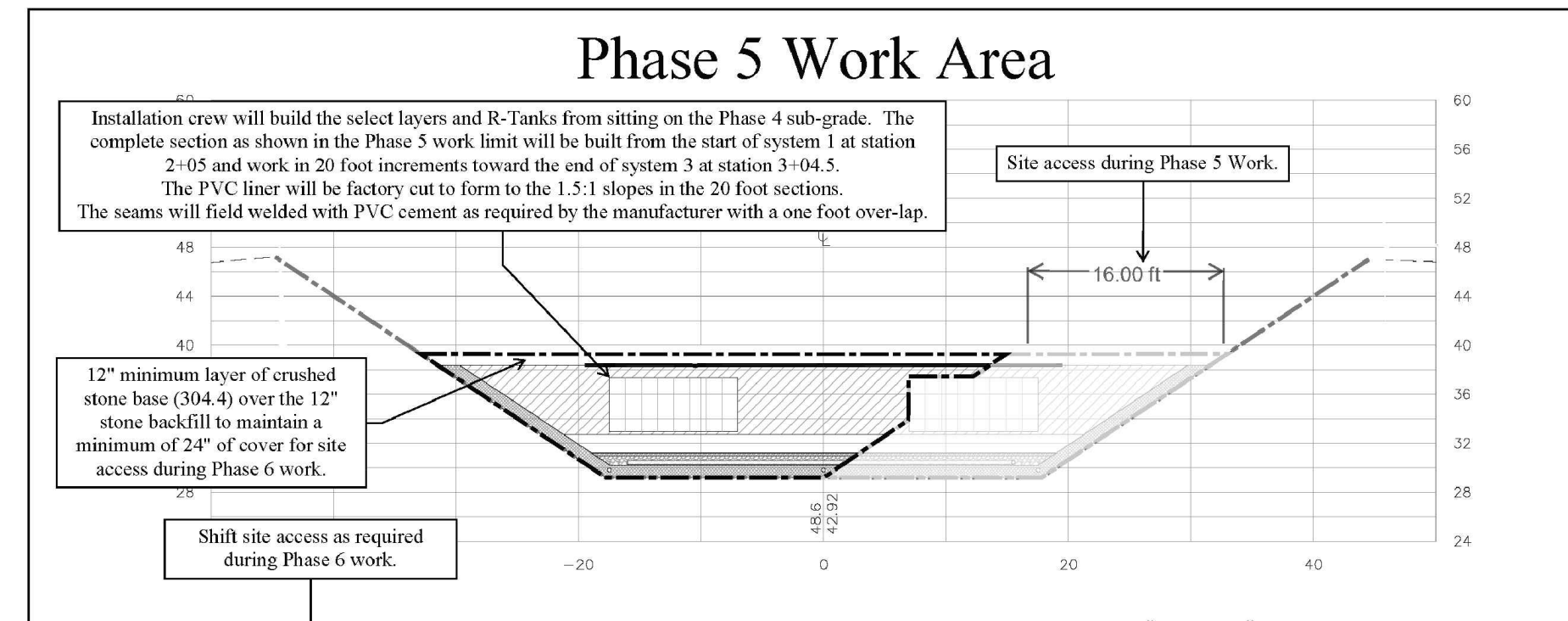
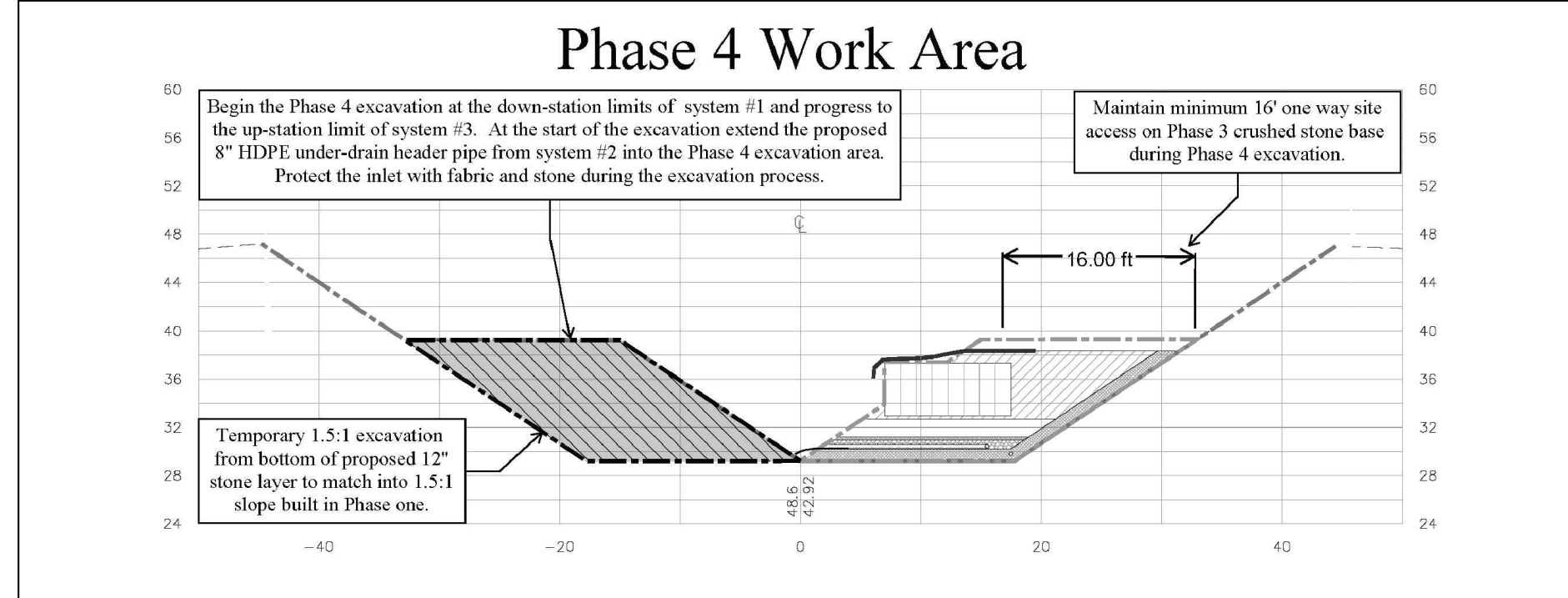
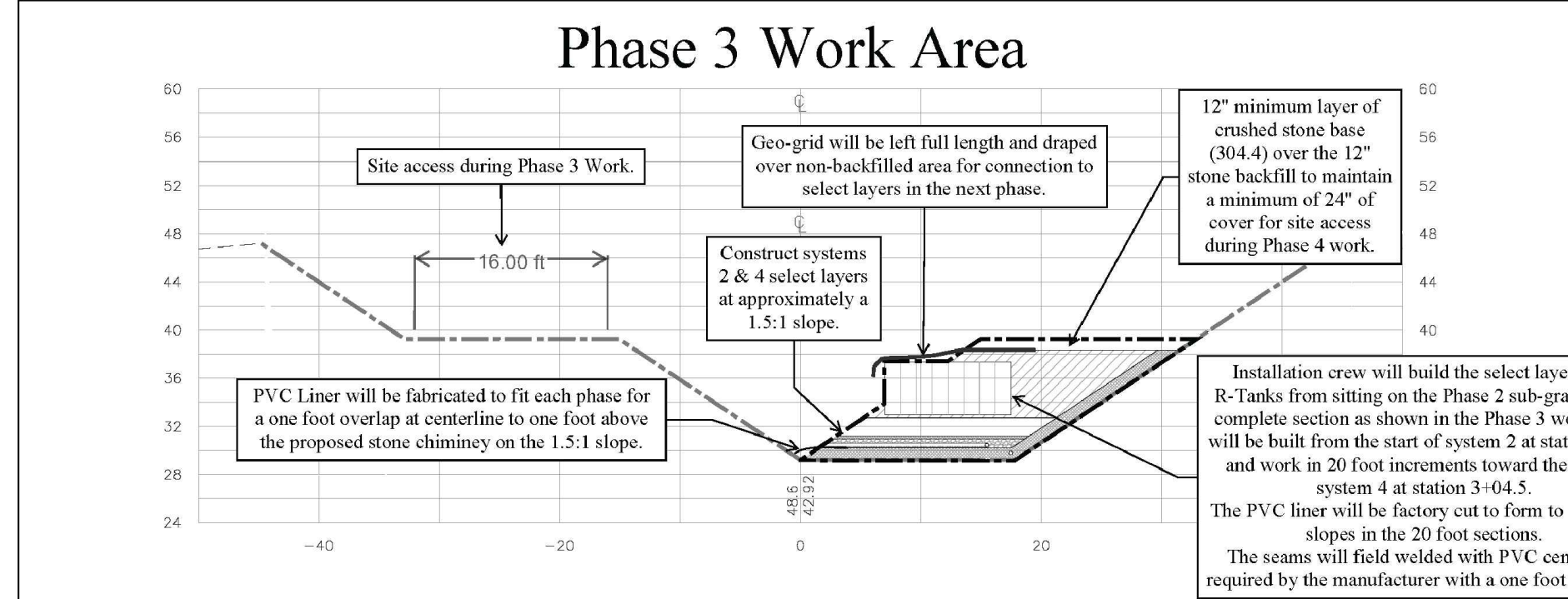
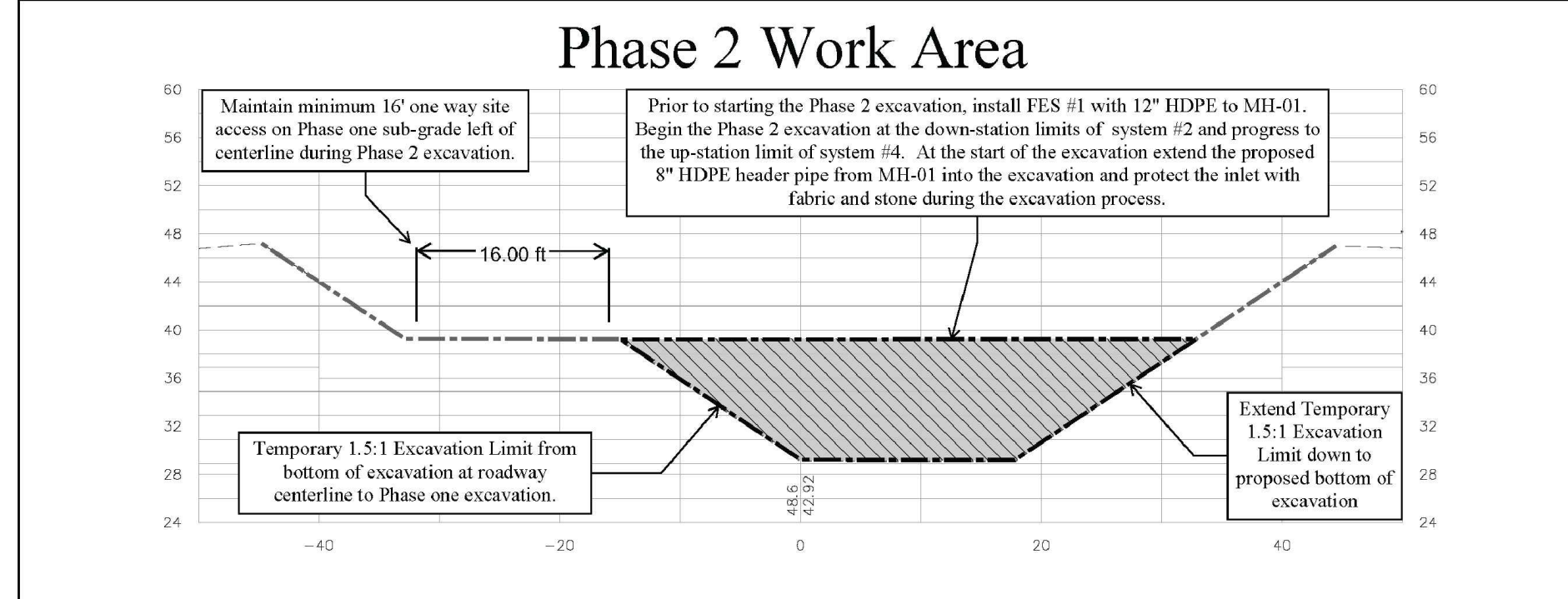
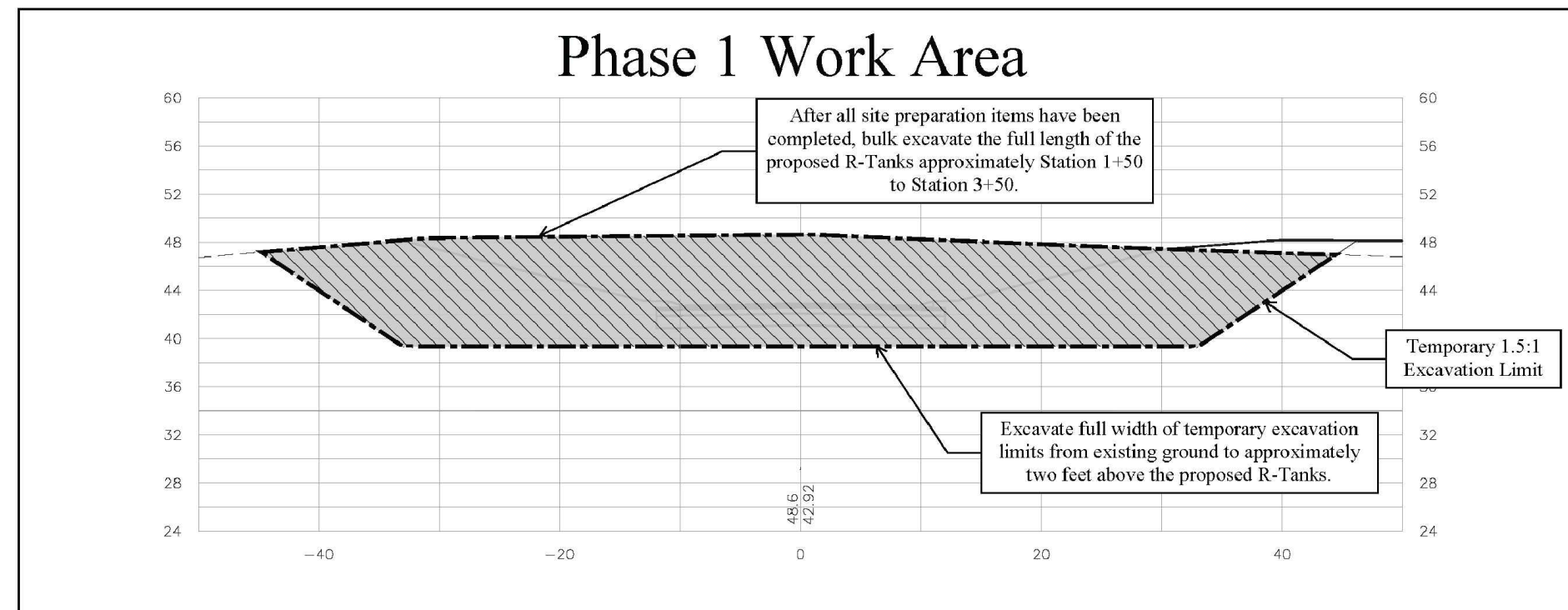

SITE DEVELOPMENT PLANS

TAX MAP 256 LOT 2
DETAILS
THE VILLAGE AT BANFIELD WOODS
PORTSMOUTH, NH
 OWNED BY
WALTER D HETT TRUST
 PREPARED FOR
GREEN & COMPANY REAL ESTATE

SCALE: **SEPTEMBER 25, 2019**

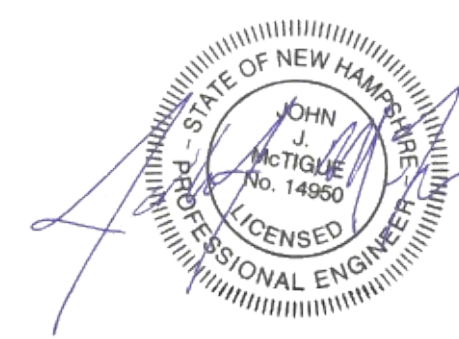

REV	DATE	DESCRIPTION	DR	CK
6	5/5/2020	AoT SUBMITTAL	RCK	JJM
5	4/29/2020	REVISOR PER REGULATORY COMMENTS	RCK	JJM
4	3/20/2020	PROGRESS PRINT	RCK	JJM
3	3/4/2020	UPDATE PLANS PER REGULATORY COMMENTS	RCK	JJM
2	12/27/2019	IN HOUSE REVISIONS	RCK	JJM
1	12/23/19	NO REVISIONS THIS SHEET	RCK	JJM

TFM Civil Engineers
 Structural Engineers
 Traffic Engineers
 Land Surveyors
 Landscape Architects
 Scientists

48 Constitution Drive
 Bedford, NH 03110
 Phone (603) 472-4488
 Fax (603) 472-9747
 www.tfmoran.com

FILE: 47361.00 DR RCK FB
 CK JUM CADFILE
 DETAILS C-41

May 28, 2020 - 12:08pm F:\MISC Projects\47361 - Portsmouth\47361-00 - Green & Co - Banfield Road\Design\Production Drawings\Details.dwg

Copyright 2019 © Thomas F. Moran, Inc.
 48 Constitution Drive, Bedford, N.H. 03110
 All rights reserved. These plans and materials may not be copied, duplicated, replicated or otherwise reproduced in any form whatsoever without the prior written permission of Thomas F. Moran, Inc.
 This plan is not effective unless signed by a duly authorized officer of Thomas F. Moran, Inc.



BIORETENTION FILTER MEDIA MIXTURES			
COMPONENT MATERIAL	% OF MIXTURE BY VOLUME	SIEVE NO.	% BY WEIGHT PASSING STANDARD SIEVE
BIORETENTION FILTER MEDIA OPTION A			
ASTM C-33 CONCRETE SAND	50-55		
LOAMY SAND TOPSOIL WITH FINES AS INDICATED	20-30	200	15 TO 25
MODERATELY FINE SHREDED BARK OR WOOD FIBER MULCH WITH FINES AS INDICATED	20-30	200	<5

3/8" WASHED CRUSHED STONE*		3/4" WASHED CRUSHED STONE*	
SIEVE SIZE	% PASSING BY WIGHT	SIEVE SIZE	% PASSING BY WIGHT
1/2"	100	1"	100
3/8"	95-100	3/4"	90-100
#4	22-55	1/2"	15-55
#8	0-10	#10	0-5

*EQUIVALENT TO STANDARD WASHED STONE-SECTION 702 OF NHDOT STANDARD SPECIFICATIONS

*EQUIVALENT TO STANDARD WASHED STONE-SECTION 702 OF NHDOT STANDARD SPECIFICATIONS

HYBRID BIORETENTION AREA MIX:

THE GRASS THAT IS PLANTED WITHIN A BIO-FILTRATION SYSTEM WITHIN THE BIO-MEDIA MUST CONSIST OF A COMBINATION OF WARM SEASON GRASS SEED AND COLD SEASON GRASS SEED IN ORDER FOR THE GRASS TO START GROWING FOR STABILIZATION AND CONTINUE GROWING IN THE SANDY WELL-DRAINED ENVIRONMENT. PLANTING SPECIFICATION WILL MEET REQUIREMENTS AS OUTLINED IN 'VEGETATION NEW HAMPSHIRE SAND AND GRAVEL PITS' MIX 1 (WARM SEASON GRASSES) (15 LBS/AC) AND INCLUDE ANNUAL AND PERENNIAL RYE GRASS SEED (15 LBS/AC); THE NEW ENGLAND NATIVE WARM SEASON GRASS MIX (23 LBS/AC) BY NEW ENGLAND WETLAND PLANTS, INC.; RAIN GARDEN MIX 180 (15 LBS/AC & 15 LBS/AC OF RYE)/RAIN GARDEN GRASS MIX 180 (20 LBS/AC & 10 LBS/AC OF RYE) BY ERNST CONSERVATION SEEDS, OR APPROVED EQUAL.

ENHANCED BIO-FILTRATION WITH INTERNAL STORAGE RESERVOIR (ISR):

- THE INTERNAL STORAGE RESERVOIR (ISR) WILL PROVIDE A RETENTION TIME OF AT LEAST 24 HOURS IN THE SYSTEM TO ALLOW FOR SUFFICIENT TIME FOR DENITRIFICATION AND NITROGEN REDUCTION TO OCCUR PRIOR TO DISCHARGE, THE FILTER MEDIA HAS BEEN AUGMENTED WITH MATERIALS DESIGNED AND/OR KNOWN TO BE EFFECTIVE AT CAPTURING PHOSPHOROUS. THE TOP TWELVE INCHES OF THE BIO-MEDIA WILL BE AMENDED WITH EITHER 5% BY VOLUME ELEMENTAL IRON FILINGS; 5% BY VOLUME CONTECH IMBRIUM SORPTIVE MEDIA, ABS MATERIALS BIOMAX MEDIA, OR APPROVED EQUAL, OR 5% BY WEIGHT WATER TREATMENT RESIDUALS (WTR). THE VOLUME OF THE ISR WILL EXCEED 25% OF THE WATER QUALITY VOLUME (WQV).

DESIGN REFERENCES:

- UWSC, WWW.UNH.EDU/UNHSC/NEWS/UNHSC-INNOVATIVE-BIORETENTION-TEMPLATE-POLLUTION-REDUCTIONS-GREATBAY-ESTUARY-WATERSHEDS.

NOTES

- WHEN CONTRACTOR EXCAVATES BIORETENTION AREA TO SUBGRADE, DESIGN ENGINEER SHALL PERFORM SUBSURFACE EVALUATION PRIOR TO THE PLACEMENT OF ANY SELECT MATERIAL OR OTHER BACKFILL.
- SOIL BIORETENTION FILTER MEDIA SHALL BE AS SHOWN ABOVE. "BIO-MEDIA" MEANS BIORETENTION FILTER MEDIA.
- DO NOT PLACE THE BIORETENTION SYSTEM INTO SERVICE UNTIL THE BMP HAS BEEN PLANTED AND ITS CONTRIBUTING AREAS HAVE BEEN FULLY STABILIZED.
- DO NOT DISCHARGE SEDIMENT-LADEN WATERS FROM CONSTRUCTION ACTIVITIES (RUNOFF WATER FROM EXCAVATION) TO THE BIORETENTION AREA DURING ANY STAGE OF CONSTRUCTION.
- DO NOT TRAFFIC EXPOSED SOIL SURFACE WITH CONSTRUCTION EQUIPMENT, IF FEASIBLE, PERFORM EXCAVATIONS WITH EQUIPMENT POSITIONED OUTSIDE THE LIMITS OF INFILTRATION COMPONENTS OF THE SYSTEM.
- A PROFESSIONAL ENGINEER SHALL BE PRESENT DURING THE CONSTRUCTION OF THE RAIN GARDENS TO ENSURE THAT ALL OF THE CRITERIA ARE MET AND THAT A REPORT BE SUBMITTED TO NHDES WHEN CONSTRUCTION OF THE BIORETENTION AREAS ARE COMPLETED.

MAINTENANCE REQUIREMENTS

- SYSTEMS SHOULD BE INSPECTED AT LEAST TWICE ANNUALLY, AND FOLLOWING ANY RAINFALL EXCEEDING 2.5 INCHES IN A 25-HOUR PERIOD, WITH MAINTENANCE OR REHABILITATION CONDUCTED AS WARRANTED SUCH INSPECTION.
- PRETREATMENT MEASURES SHOULD BE INSPECTED AT LEAST TWICE ANNUALLY, AND CLEANED OF ACCUMULATED SEDIMENT AS WARRANTED BY INSPECTION, BUT NO LESS THAN ONCE ANNUALLY.
- AT LEAST ONCE ANNUALLY, SYSTEM SHOULD BE INSPECTED FOR DRAWDOWN TIME. IF BIORETENTION SYSTEM DOES NOT DRAIN WITHIN 72-HOURS FOLLOWING A RAINFALL EVENT, THAN A QUALIFIED PROFESSIONAL SHOULD ASSESS THE CONDITION OF THE FACILITY TO DETERMINE MEASURES REQUIRED TO RESTORE FILTRATION FUNCTION OR INFILTRATION FUNCTION, INCLUDING BUT NOT LIMITED TO REMOVAL OF ACCUMULATED OF SEDIMENTS OR RECONSTRUCTION OF FILTER MEDIA.
- VEGETATION SHOULD BE INSPECTED AT LEAST ANNUALLY AND MAINTAINED IN HEALTHY CONDITION, INCLUDING PRUNING, REMOVAL, AND REPLACEMENT OF DEAD OR DISEASED VEGETATION, AND REMOVAL OF INVASIVE SPECIES.

DESIGN REFERENCES:

- UNH STORMWATER CENTER
- NEW HAMPSHIRE STORMWATER MANAGEMENT MANUAL, VOLUME 2, DECEMBER 2008 AS AMENDED.

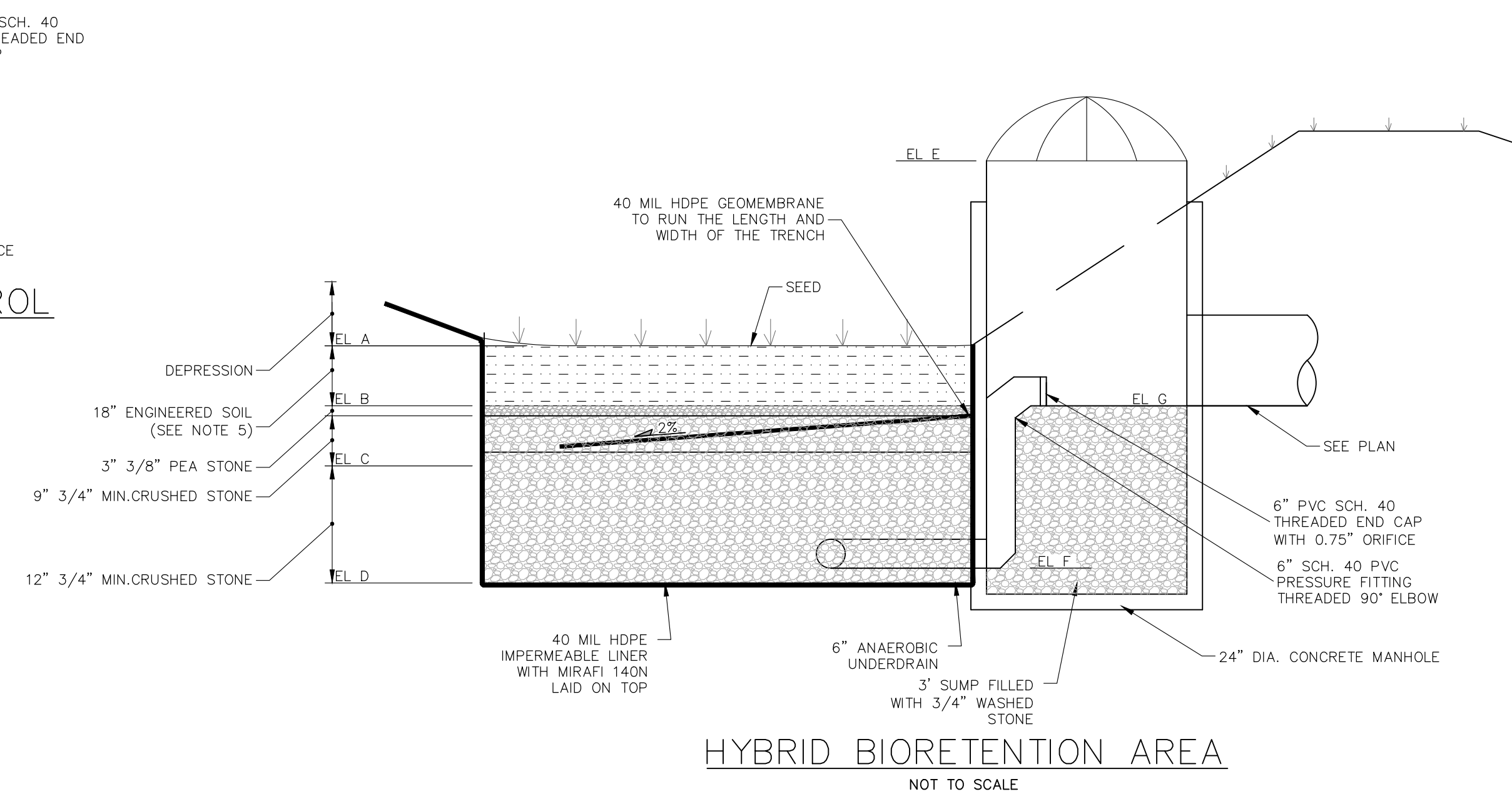
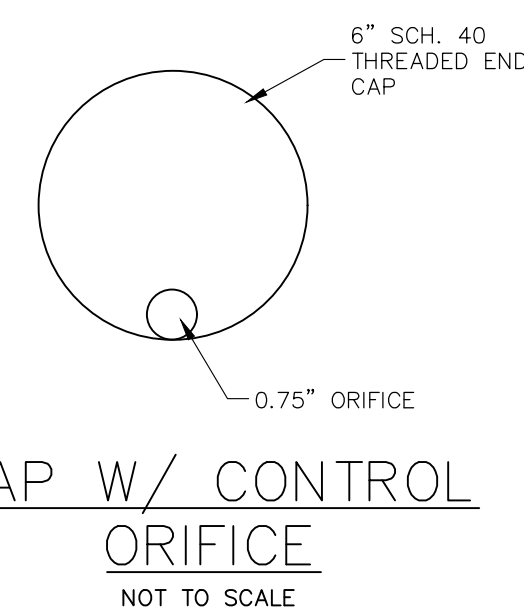
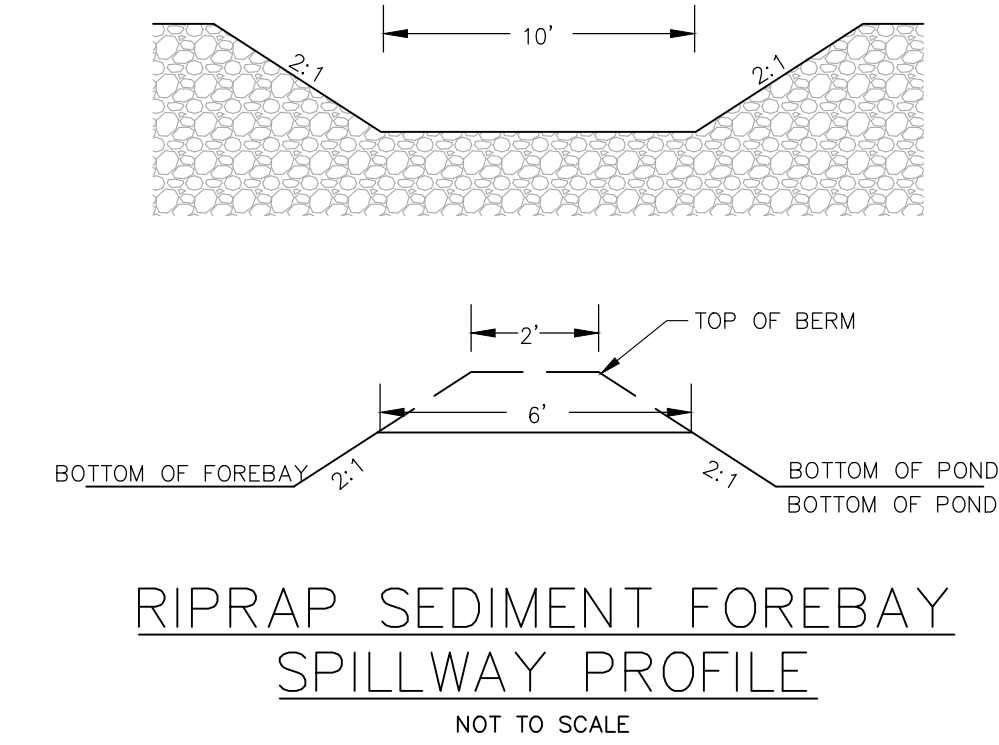
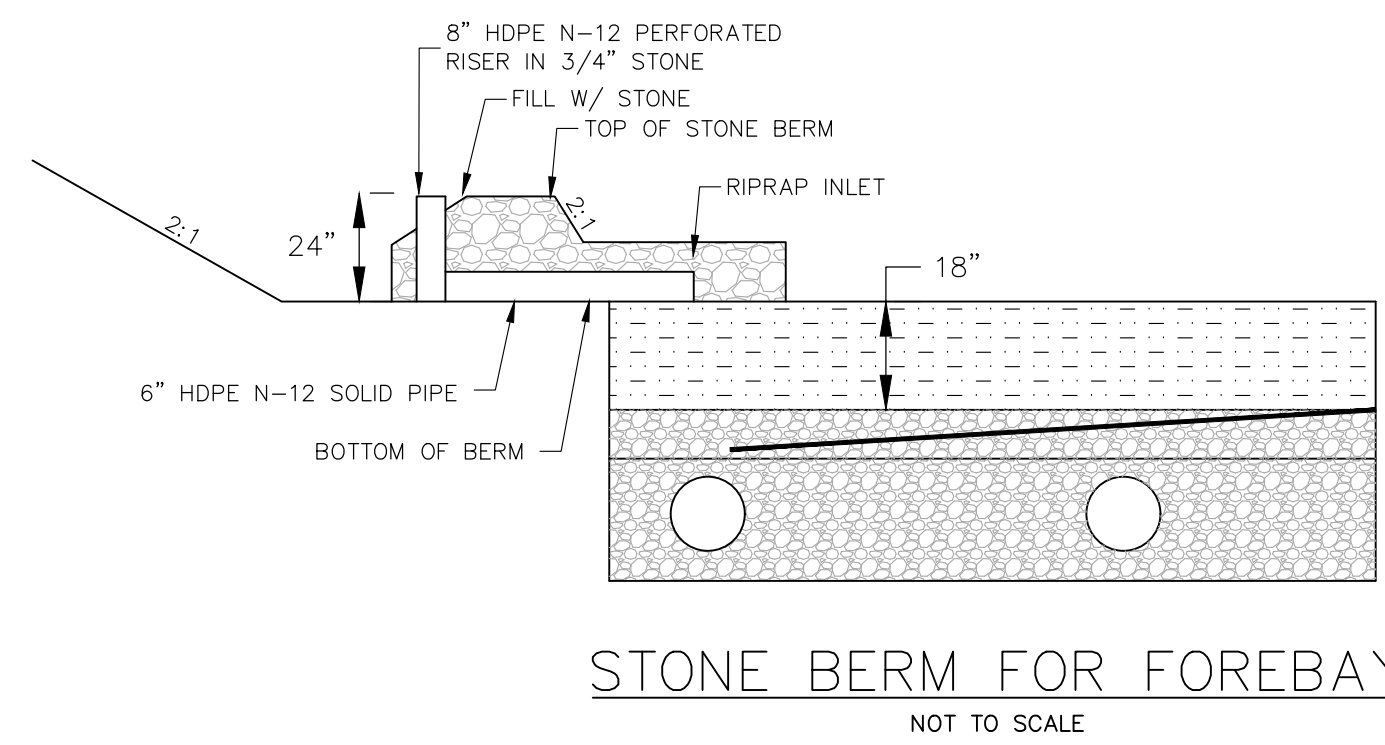
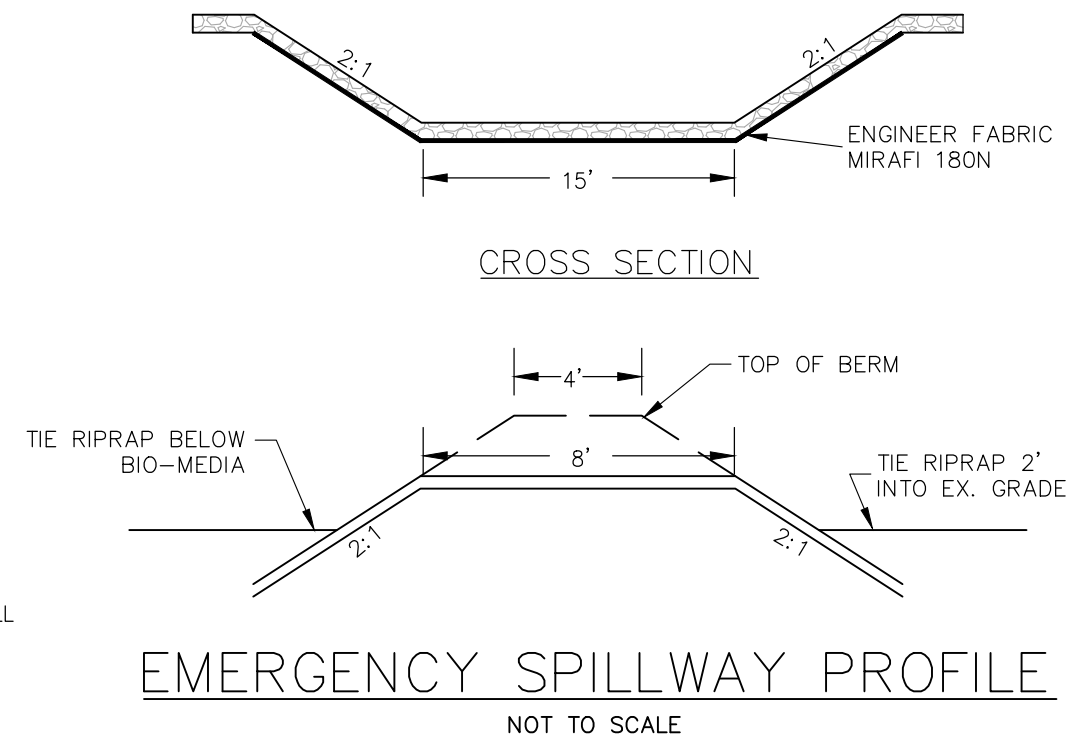

LINER NOTES
ACCEPTABLE OPTIONS INCLUDE:
A. 6-12" IN CLAY SOIL (MINIMUM 15% PASSING #200 SIEVE AND A MAXIMUM PERMEABILITY OF 1X10⁻⁵ CM/S)
* A 40 MIL PVC LINER WITH SAND BEDDING AND NON-WOVEN GEOTEXTILE

ELEVATION TABLE		
	ELEV	ELEV
A	46.00	43.50
B	44.50	42.00
C	43.50	41.00
D	42.50	40.00
E	47.75	45.25
F	45.25 (3" ORIFICE)	42.75 (0.5" ORIFICE)
G	42.75	42.75

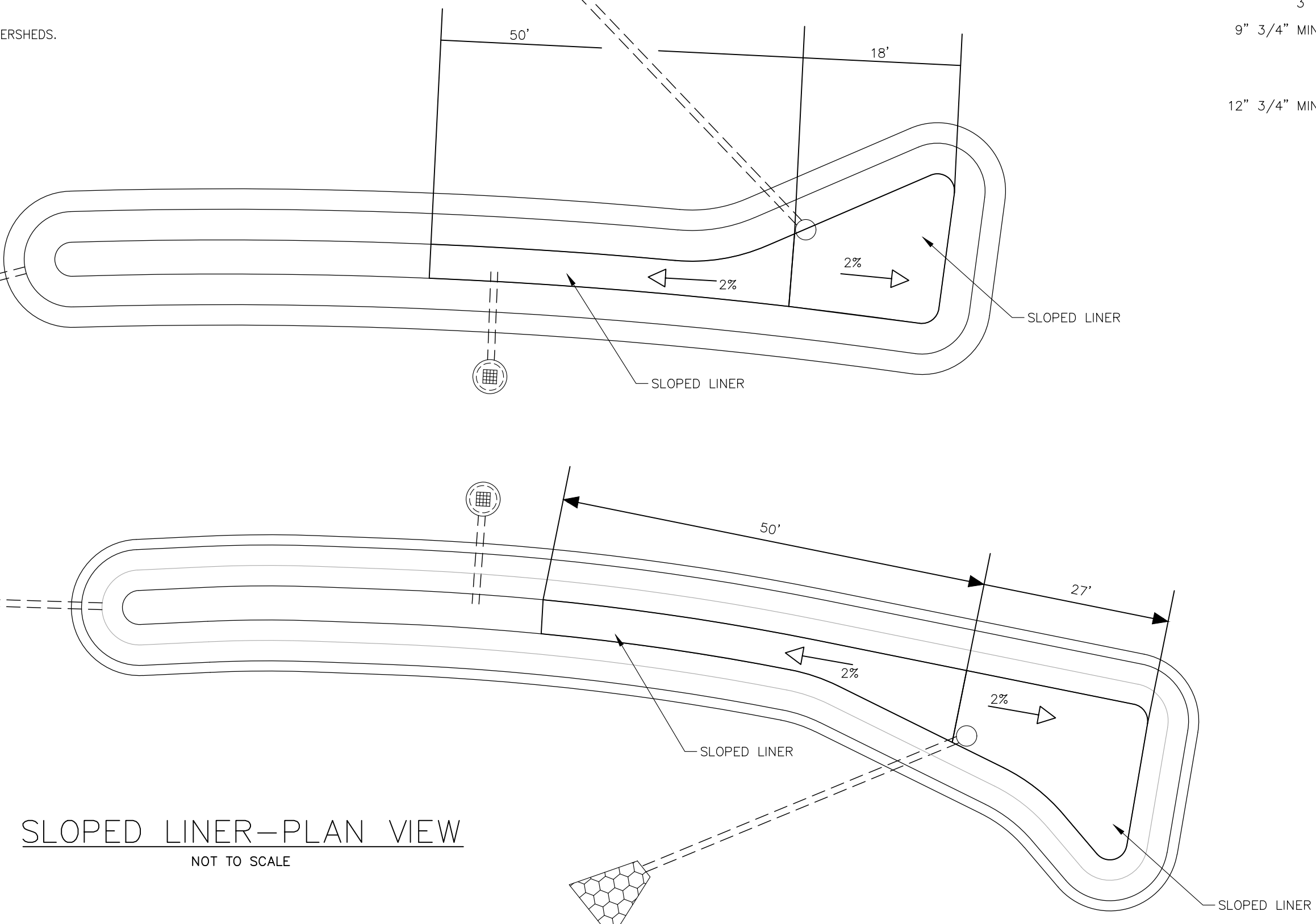

SLOPED LINER-PLAN VIEW
NOT TO SCALE

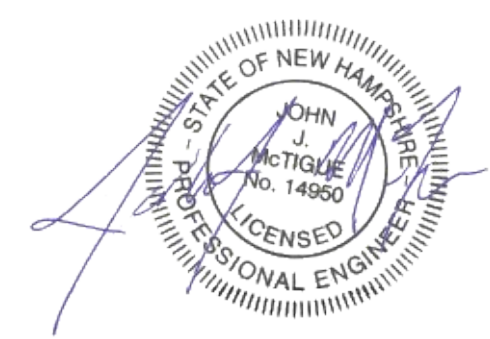

SITE DEVELOPMENT PLANS
TAX MAP 256 LOT 2
DETAILS
THE VILLAGE AT BANFIELD WOODS
PORTSMOUTH, NH
OWNED BY
WALTER D HETT TRUST
PREPARED FOR
GREEN & COMPANY REAL ESTATE
SCALE: SEPTEMBER 25, 2019

REV	DATE	DESCRIPTION	DR	CK
6	5/5/2020	AoT SUBMITTAL	RCK	JJM
5	4/29/2020	REVISOR PER REGULATORY COMMENTS	RCK	JJM
4	3/20/2020	PROGRESS PRINT	RCK	JJM
3	3/4/2020	UPDATE PLANS PER REGULATORY COMMENTS	RCK	JJM
2	12/27/2019	IN HOUSE REVISIONS	RCK	JJM
1	12/23/19	NO REVISIONS THIS SHEET	RCK	JJM

TFM Civil Engineers
Structural Engineers
Traffic Engineers
Land Surveyors
Landscape Architects
Scientists

48 Constitution Drive
Bedford, NH 03110
Phone (603) 472-4488
Fax (603) 472-9747
www.tfmoran.com

47361.00 DR RCK FB
CK JJM CADFILE
DETAILS
C-42

May 28, 2020 - 12:08pm
F:\MISC Projects\47361 - Portsmouth\47361-00 - Green & Co - Banfield Road\Design\Production Drawings\Details.dwg

Copyright 2019 © Thomas F. Moran, Inc.
48 Constitution Drive, Bedford, N.H. 03110
All rights reserved. These plans and materials may not be copied, duplicated, replicated or otherwise reproduced in any form whatsoever without the prior written permission of Thomas F. Moran, Inc.
This plan is not effective unless signed by a duly authorized officer of Thomas F. Moran, Inc.



PRETX SPECIFICATIONS

- A. GENERAL**
- PRETX SYSTEMS ARE A PRE-FILTER AND CRITICAL MAINTENANCE DEVICE THAT EXTENDS THE OPERATING LIFE AND REDUCES THE MAINTENANCE BURDEN OF BIORETENTION SYSTEMS, RAIN GARDENS, BIOSWALES AND OTHER TYPES OF SURFACE BEST MANAGEMENT PRACTICES BY FILTERING OUT SEDIMENT, TRASH AND DEBRIS AT THE INLET.
- B. PRODUCTS**
- PRETX IS AVAILABLE IN 3 MODELS THAT MANAGE MOST BIORETENTION INLET CONFIGURATIONS: CURB, DROP, AND INLINE.
 - PRETX-CURB IS FOR EDGE OF PAVEMENT RUNOFF AT A CURB CUT IN LIEU OF A STONE SPREADER.
 - PRETX-DROP IS FOR USE AS A DROP INLET CONFIGURATION ALONG A CURB LINE AND WOULD BE INSTALLED WITH A STANDARD DROP INLET GRATE.
 - PRETX-INLINE IS FOR USE WITH SUBSURFACE INLET AND OUTLET PIPE.
 - PRETX IS SIZED TO PRETREAT WATER QUALITY FLOWS AND BYPASS LARGER FLOWS THAT HAVE MINIMAL TRASH AND DEBRIS. PRETX CAN BE USED BOTH IN RETROFIT OR NEW INSTALLATIONS.
 - ACCEPTABLE SYSTEM SUPPLIER:
CONVERGENT WATER TECHNOLOGIES, INC. OR ITS AUTHORIZED VALUE-ADDED RESELLER
(800) 711-5428
WWW.CONVERGENTWATER.COM
- C. SUBMITTALS**
- SUBMIT PROPOSED LAYOUT DRAWINGS. DRAWINGS SHALL INCLUDE TYPICAL SECTION DETAILS ANNOTED WITH SYSTEM ELEVATIONS (E.G., RIM, PIPE INVERTS, OUTSIDE BOTTOM OF STRUCTURE, ETC.).
 - SUBMIT MATERIAL CERTIFICATES FOR FRAMES AND COVERS
 - ANY PROPOSED EQUAL ALTERNATE PRODUCT SUBSTITUTION TO THIS SPECIFICATION MUST BE SUBMITTED FOR REVIEW AND APPROVED PRIOR TO BID OPENING.
- D. EXECUTION**
- ALL PUBLIC STORM DRAINAGE SYSTEMS SHALL BE CONSTRUCTED IN ACCORDANCE WITH THE LATEST EDITION OF THE STATE DEPARTMENT OF TRANSPORTATION STANDARDS AND SPECIFICATIONS AND ACCORDING TO LOCAL MUNICIPAL REQUIREMENTS.
 - ALL STORM DRAINAGE SYSTEM CONSTRUCTION IS SUBJECT TO INSPECTION AND APPROVAL BY THE PROJECT ENGINEER.
 - THE CONTRACTOR SHALL NOTIFY THE PROJECT ENGINEER A MINIMUM OF TWO FULL BUSINESS DAYS PRIOR TO THE START OF CONSTRUCTION.
 - THE CONTRACTOR SHALL BE RESPONSIBLE FOR CONTACTING AND OBTAINING APPROVAL FROM DIG-SAFE AND DETERMINING THE LOCATION OF ALL UNDERGROUND UTILITIES PRIOR TO THE START OF CONSTRUCTION/ EXCAVATION AND SHALL NOTIFY THE PROJECT ENGINEER OF ANY POTENTIAL CONFLICTS.
 - TO PROTECT STORMWATER FLOW CONTROL AND QUALITY TREATMENT FACILITIES FROM SEDIMENTATION, THEY SHALL BE CONNECTED TO THE STORM CONVEYANCE SYSTEM ONLY AFTER ALL SITE WORK, ROAD CONSTRUCTION, UTILITY WORK AND LANDSCAPING ARE IN PLACE IN ALL AREAS ABOVE AND UPSTREAM OF THE FACILITY.
 - THE EXISTING STORM SEWER SYSTEM SHALL STAY ISOLATED FROM THE NEW SYSTEM UNTIL THE NEW SYSTEM IS CLEANED, AND APPROVED FOR USE. THERE SHALL BE NO DEBRIS IN THE LINES OR FURTHER CLEANING WILL BE REQUIRED PRIOR TO ACCEPTANCE.
 - PROVIDE A 1.5" MINIMUM GAP BETWEEN THE KNOCKOUT WALL AND THE OUTSIDE OF THE PIPE. AFTER THE PIPE IS INSTALLED, FILL THE GAP WITH JOINT MORTAR.
 - THE OPENING SHALL BE MEASURED AT THE TOP OF THE PRECAST BASE SECTION.
 - ALL PICKUP HOLES SHALL BE GROUTED FULL AFTER THE BASIN HAS BEEN PLACED.
 - STANDARD CURB INLETS AND TIPDOWNS SHALL BE PRECAST CONCRETE OR ASPHALT.
 - PIPE ENDS SHALL BE FLUSH WITH THE INNER WALL OR 1" MAXIMUM INTRUSION. MASONRY, CINDER BLOCKS, OR SIMILAR MATERIALS MAY BE USED TO ADJUST THE RISERS TO GRADE PRIOR TO GROUTING.
 - GROUTING SHALL BE SUFFICIENT TO PREVENT LEAKS BETWEEN THE PRECAST COMPONENTS OF THE COMPLETED STRUCTURE & SHALL BE PERFORMED INSIDE, BETWEEN & OUTSIDE OF ALL RISERS, JOINTS & PIPE PENETRATIONS.
 - MANHOLES TO BE CONSTRUCTED IN ACCORDANCE WITH AASHTO M-199 UNLESS OTHERWISE SHOWN ON PLANS OR NOTED IN THE STANDARD SPECIFICATIONS.
 - ALL REINFORCED CAST IN PLACE CONCRETE SHALL BE CLASS 4000. ALL PRECAST CONCRETE SHALL BE CLASS 4000.
 - RECAST BASES SHALL BE FURNISHED WITH CUTOUTS OR KNOCKOUTS. KNOCKOUTS SHALL HAVE A WALL THICKNESS OF 2" MINIMUM.
 - MATING SURFACES OF MANHOLE RINGS AND COVERS SHALL BE FINISHED TO ASSURE NON-ROCKING FIT WITH ANY COVER POSITIONS.
- E. CONSTRUCTION AND SEQUENCING**
- EXAMINATION
 - VERIFY LAYOUT AND ORIENTATION OF PRE-TX SYSTEM AREA INCLUDING EDGE OF PAVEMENT, TIP DOWN, CURBS AND SIDEWALK, BIOFILTRATION SYSTEM, AND CONNECTIONS.
 - VERIFY EXCAVATION BASE IS READY TO RECEIVE WORK AND EXCAVATIONS, DIMENSIONS, AND ELEVATIONS ARE AS INDICATED ON DRAWINGS.
 - PREPARATION
 - CALL DIG SAFE AND RECEIVE APPROVAL BEFORE PERFORMING WORK.
 - REQUEST UNDERGROUND UTILITIES TO BE LOCATED AND MARKED WITHIN AND SURROUNDING CONSTRUCTION AREAS.
 - IDENTIFY REQUIRED LINES, LEVELS, CONTOURS, AND DATUM.
 - CLEAR AND GRUB THE PROPOSED PRE-TX SYSTEM AREA.
 - EXCAVATION AND INSTALLATION
 - THE FOLLOWING CONSTRUCTION SEQUENCE IS TO BE USED AS A GENERAL GUIDELINE. COORDINATE WITH THE OWNER, AND ENGINEERS FOR REVIEW AND APPROVAL PRIOR TO CONSTRUCTION.
 - INSTALL TEMPORARY EROSION AND SEDIMENT CONTROLS TO DIVERT STORM WATER AWAY FROM THE PRE-TX SYSTEM AREA.
 - EXCAVATE TO THE BOTTOM INVERT OF THE SYSTEM.
 - TO MINIMIZE COMPACTION OF ADJACENT BIOFILTRATION SYSTEMS, WORK EXCAVATORS OR BACKHOES FROM THE SIDES TO EXCAVATE THE PRE-TX SYSTEM AREA TO ITS APPROPRIATE DESIGN DEPTH AND DIMENSIONS.
 - ROUGH GRADE THE PRE-TX SYSTEM AREA DURING GENERAL CONSTRUCTION. EXCAVATE THE PRE-TX SYSTEM FACILITIES TO WITHIN 1 FOOT OF STRUCTURE BOTTOM.
 - PLACE 1 FOOT BED OF COARSE STONE TO ELEVATION OF BASE OF STRUCTURE.
 - ESTABLISH ELEVATIONS FOR ADJACENT CURBS, EDGE OF PAVEMENT AND TIP DOWN, SIDEWALK, PIPE INVERTS FOR INLETS AND OUTLETS AS INDICATED ON DRAWINGS.
 - INSTALLATION
 - PLACE THE PRECAST SYSTEM TO NECESSARY ELEVATION.
 - VERIFY ELEVATIONS FOR ADJACENT CURBS, EDGE OF PAVEMENT, PAVEMENT GRADING FOR INLET GRATE FOR PRETX-DROP, SIDEWALK, PIPE INVERTS FOR INLETS AND OUTLETS, OUTLET INVERT FOR KNEE WALL.
 - FOR PRETX-SURFACE:
 - VERIFY ELEVATIONS FOR ADJACENT CURBS.
 - VERIFY EDGE OF PAVEMENT TIP DOWN PAVEMENT GRADING FOR INLET GRATE.
 - VERIFY CURB ELEVATION IN RELATION TO PAVEMENT AND TIP DOWN.
 - VERIFY OUTLET INVERT FOR KNEE WALL IN RELATION TO FILTER MEDIA.
 - FOR PRETX-DROP:
 - VERIFY ALL INLET PIPES ENTER THE STRUCTURE UPSTREAM OF BAFFLE.
 - VERIFY FRAME AND GRATE OFFSET ON INLET SIDE AND UPSTREAM OF BAFFLE.
 - VERIFY CURB LOCATION WITH RESPECT TO FRAME AND GRATE ORIENTATION.
 - INSTALL BAFFLES, WEIR, AND SCREENS AS INDICATED ON DRAWINGS.
 - VERIFY MAINTENANCE ACCESS THROUGH GRATE OR COVER AND CLEARANCE FOR VACTOR.
 - INSTALL TOP OF STRUCTURE LEVEL WITH ADJACENT CURB OR SIDEWALK AS PER MANUFACTURERS SPECIFICATIONS. ENGINEER FIELD VISIT REQUIRED PRIOR TO BACKFILLING.
- BACKFILLING
 - BACKFILL WITH APPROVED SOIL AND STONE TO THE DESIGN GRADE AS SPECIFIED IN THE DRAWINGS.
 - BACKFILL WITH 12" OF NO. 57 STONE AROUND REAR, LEFT, AND RIGHT SIDES TO LEVEL WITH TOP OF HDPE SCREEN.
 - BACKFILL WITH BIORETENTION SOIL MIX BEYOND STONE BACKFILL TO EQUAL ELEVATION OF THE TOP OF HDPE SCREEN.
 - DO NOT BACKFILL SOIL OR STONE AGAINST STAINLESS SCREEN.
 - DO NOT COMPACT ADJACENT FILTRATION SYSTEM SOIL WITH MECHANICAL EQUIPMENT.
 - STABILIZE ALL REMAINING DISTURBED AREAS AND SIDE SLOPES WITH SEEDING, HYDROSEEDING, AND/ OR EROSION CONTROL BLANKETS AS INDICATED ON DRAWINGS.
- CLEAN UP
 - AFTER COMPLETION OF THE WORK, REMOVE AND PROPERLY DISPOSE ALL DEBRIS, CONSTRUCTION MATERIALS, RUBBISH, EXCESS SOIL, ETC., FROM THE PROJECT SITE. REPAIR PROMPTLY ANY IDENTIFIED DEFICIENCIES AND LEAVE THE PROJECT SITE IN A CLEAN AND SATISFACTORY CONDITION.

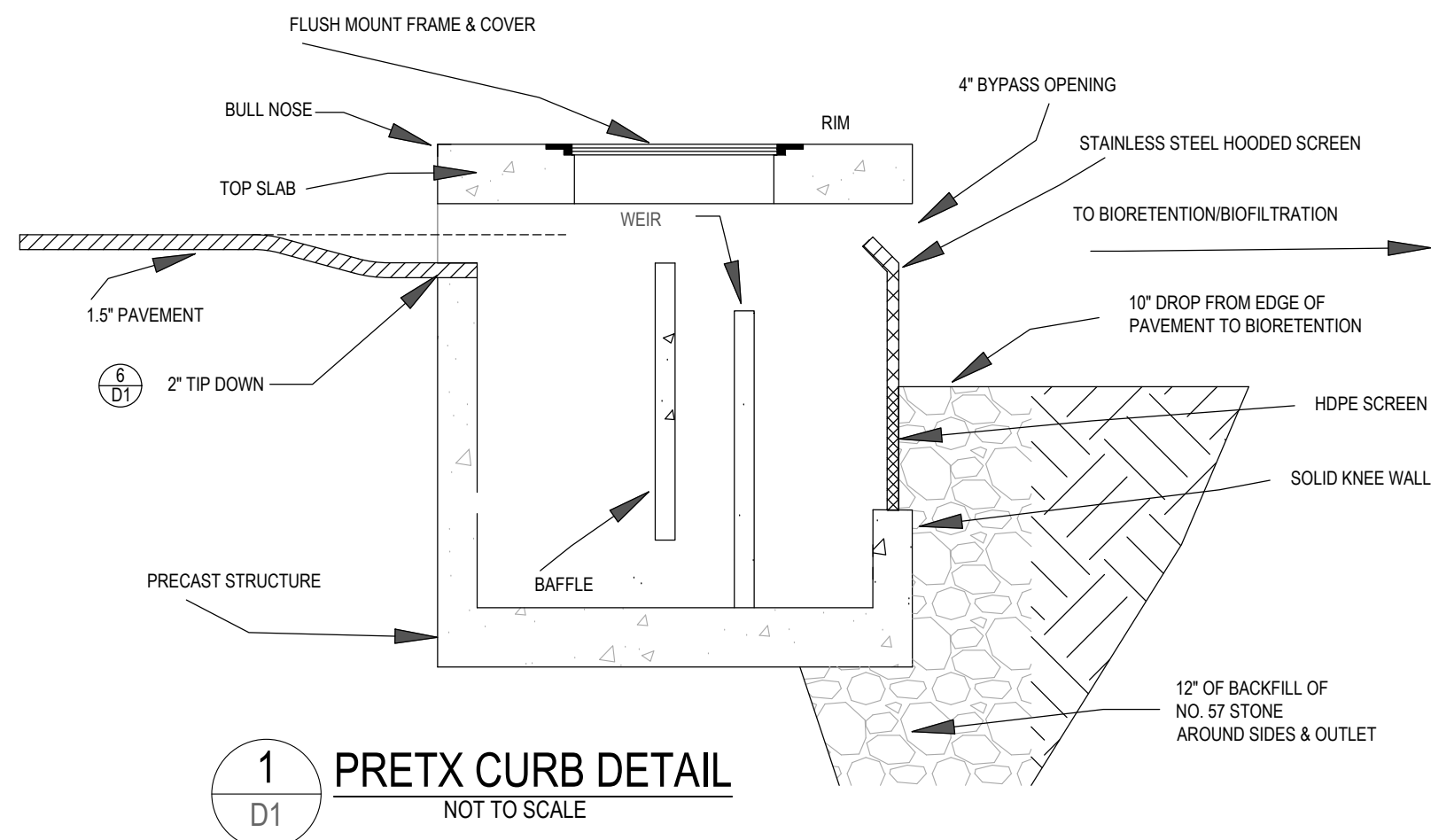

1 PRETX CURB DETAIL
NOT TO SCALE

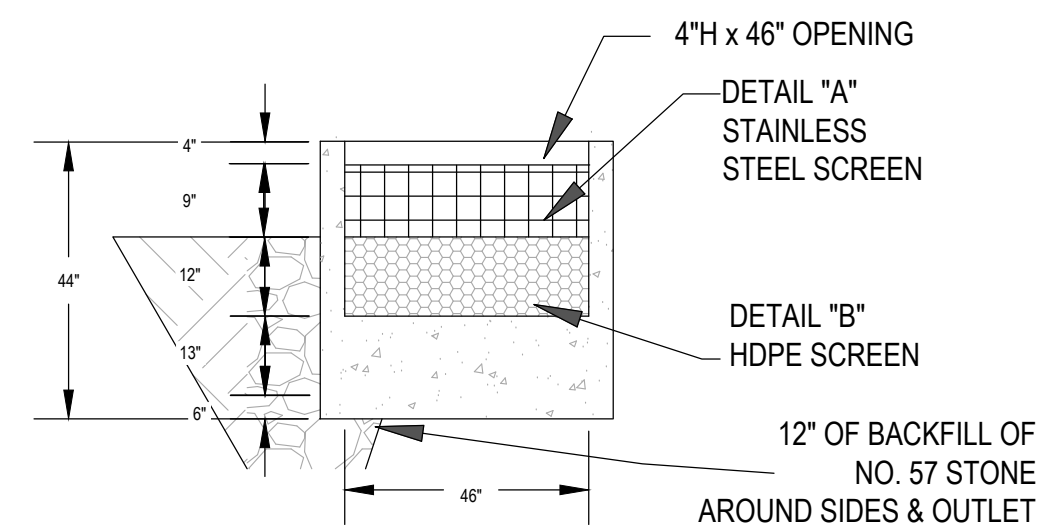

3 PRETX CURB OUTLET SIDE
NOT TO SCALE

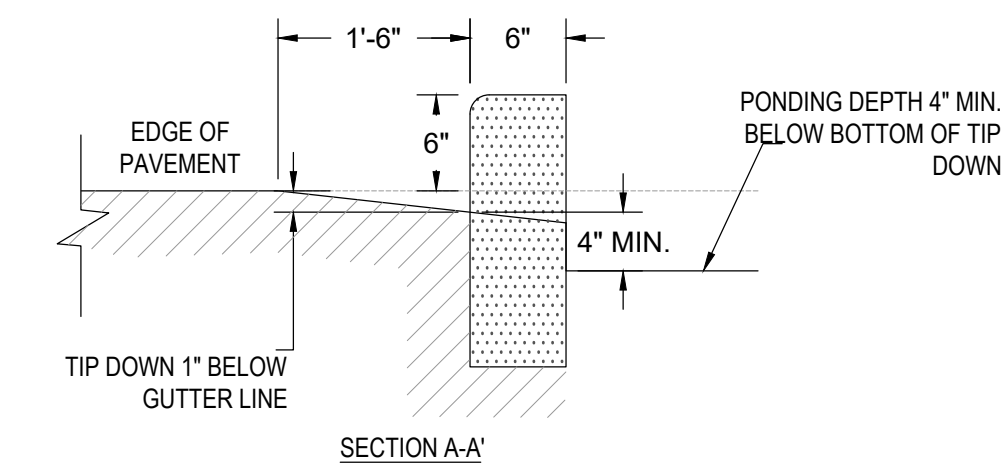

5 TIP DOWN CURB INLET DETAIL
NOT TO SCALE

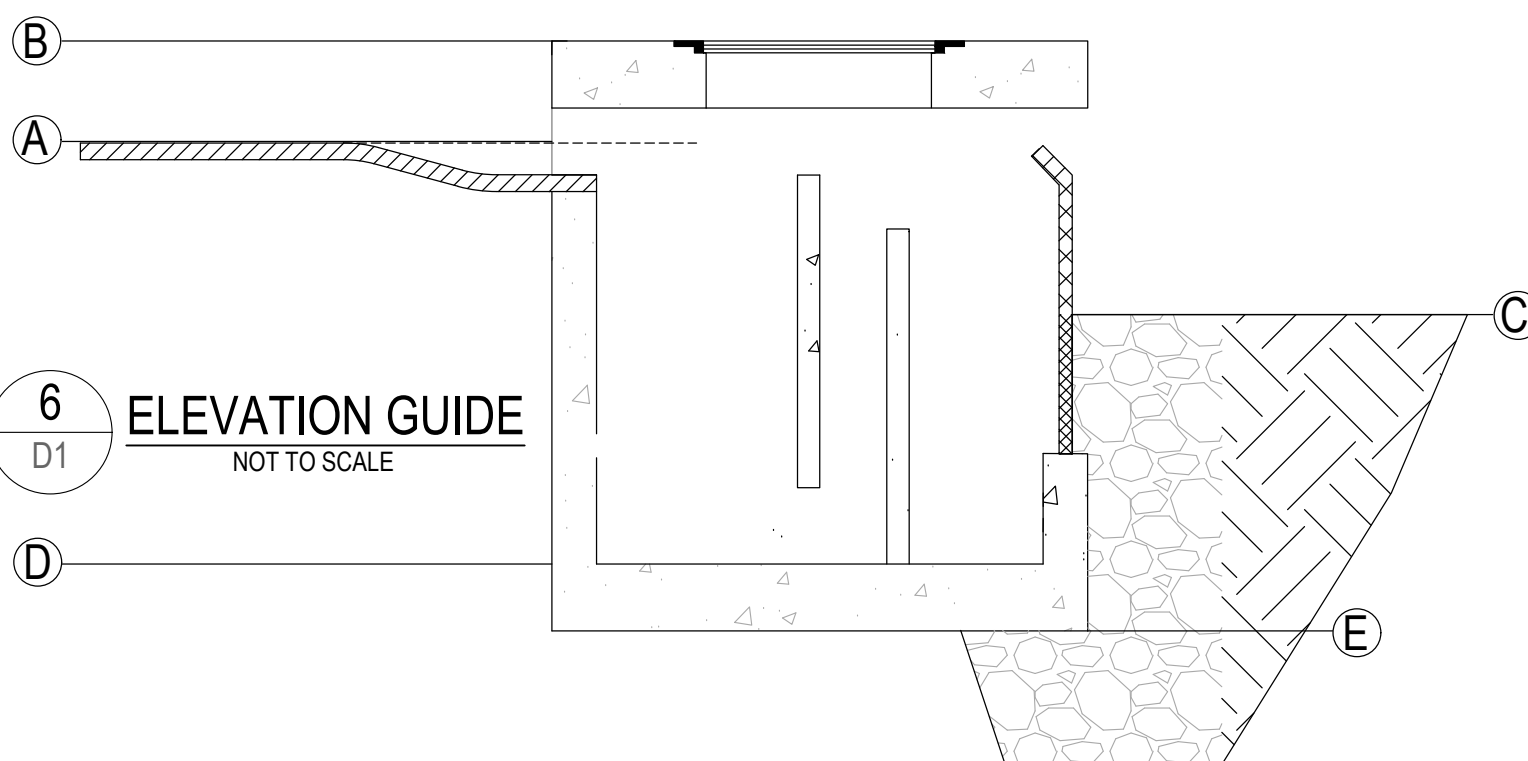

6 ELEVATION GUIDE
NOT TO SCALE

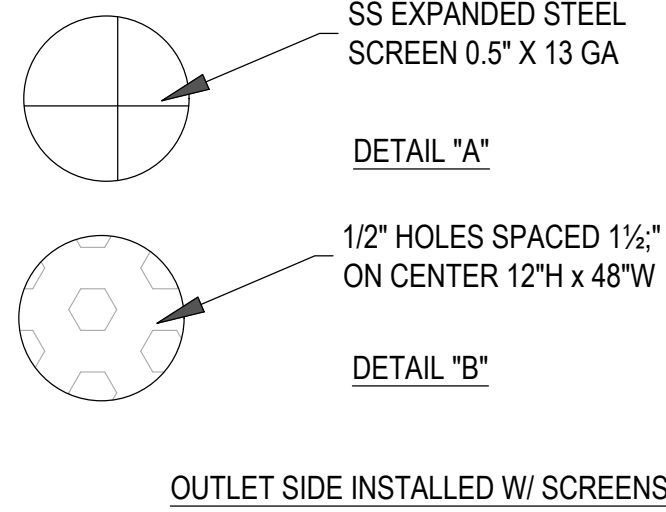

OUTLET SIDE INSTALLED W/ SCREENS

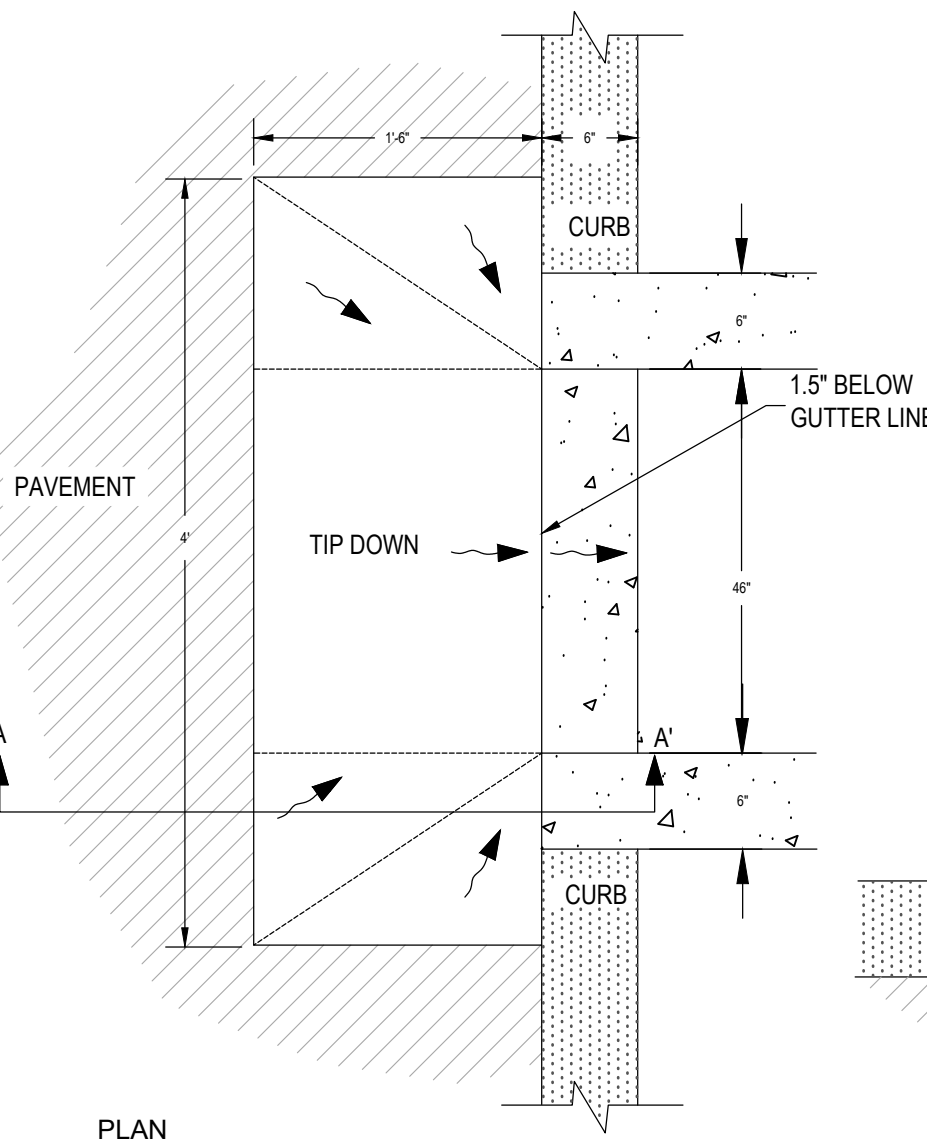

PLAN

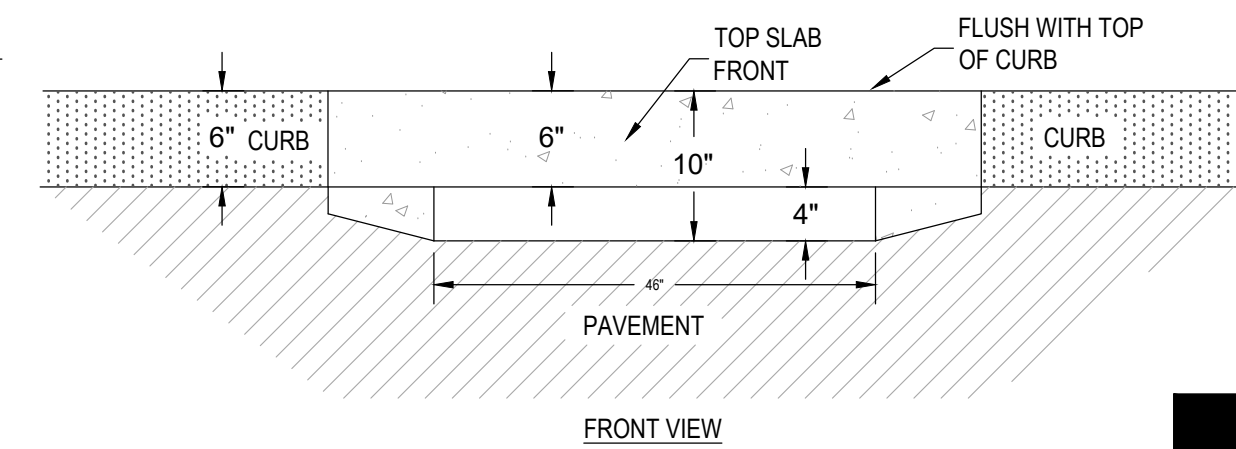

FRONT VIEW

POINT	DESCRIPTION	HEIGHT IN REFERENCE TO PT. A
A	EDGE OF PAVEMENT	0 INCHES
B	OUTSIDE TOP SLAB	8 INCHES
C	TOP OF BIORETENTION	12 INCHES
D	SUMP INVERT	36 INCHES
E	OUTSIDE BOTTOM	42 INCHES

REV	DATE	DESCRIPTION	DR	CK
6	5/5/2020	AoT SUBMITTAL	RCK	JJM
5	4/29/2020	REVISOR PER REGULATORY COMMENTS	RCK	JJM
4	3/20/2020	PROGRESS PRINT	RCK	JJM
3	3/4/2020	UPDATE PLANS PER REGULATORY COMMENTS	RCK	JJM
2	12/27/2019	IN HOUSE REVISIONS	RCK	JJM
1	12/23/19	NO REVISIONS THIS SHEET	RCK	JJM

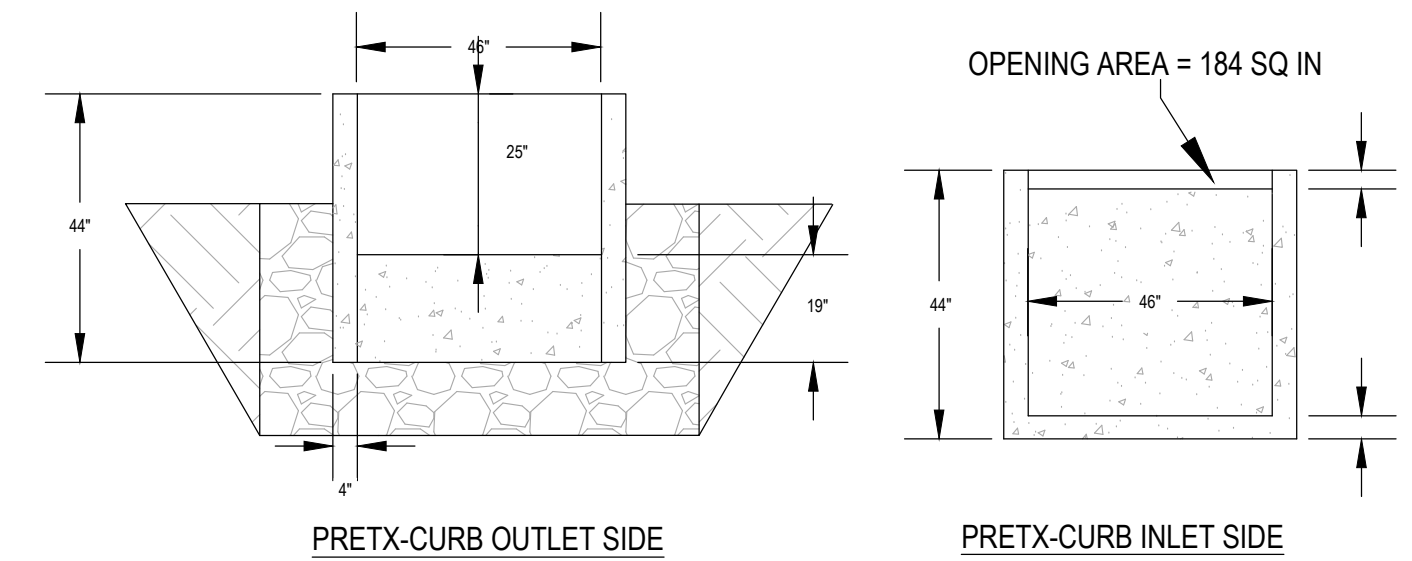

4 PRETX CURB SIDE DETAIL
NOT TO SCALE

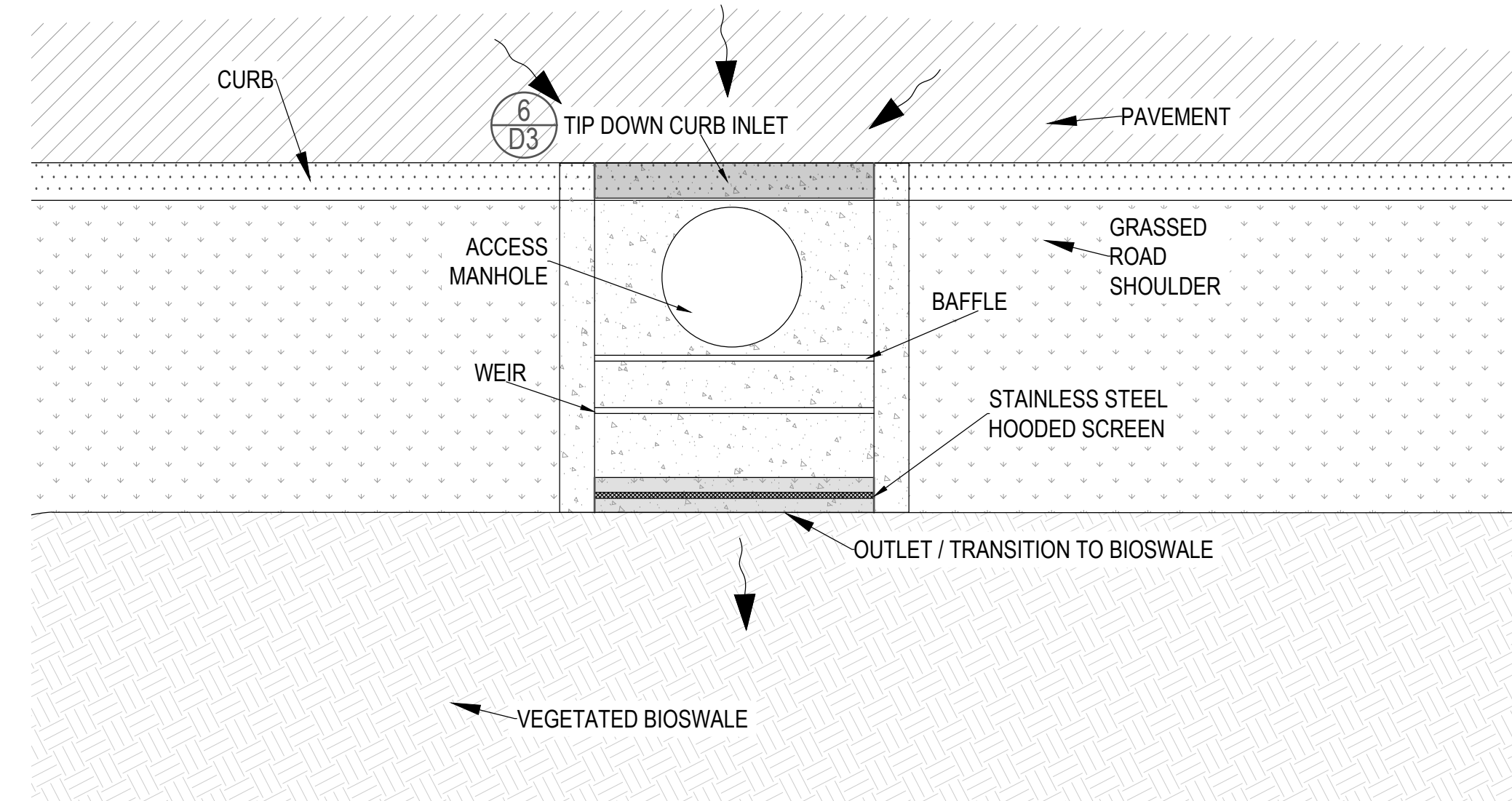

7 PRETX CURB OUTLET TO BIORETENTION CONFIGURATION

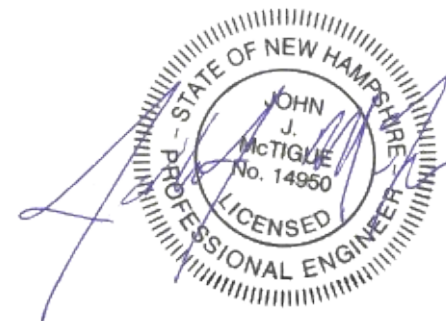

SITE DEVELOPMENT PLANS

TAX MAP 256 LOT 2
DETAILS
THE VILLAGE AT BANFIELD WOODS
PORTSMOUTH, NH
 OWNED BY
WALTER D HETT TRUST
 PREPARED FOR
GREEN & COMPANY REAL ESTATE

SCALE: **SEPTEMBER 25, 2019**

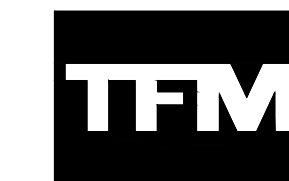

Civil Engineers
 Structural Engineers
 Traffic Engineers
 Land Surveyors
 Landscape Architects
 Scientists

48 Constitution Drive
 Bedford, NH 03110
 Phone (603) 472-4488
 Fax (603) 472-9747
 www.tfmoran.com

47361.00 DR RCK FB
 CK JJM CADFILE
 DETAILS C-43



**DECLARATION OF CONDOMINIUM
OF
BANFIELD WOODS CONDOMINIUM, PORTSMOUTH, NEW HAMPSHIRE**

This Declaration is made this ____ day of _____, 2020 by Green & Co. Building & Development Corp., a Massachusetts corporation with a place of business at 11 Lafayette Road, North Hampton, New Hampshire 03862, and its successors or assigns, (“Declarant”) for the purpose of submitting certain property described in this Declaration to condominium usage and to ownership in accordance with the provisions of the Condominium Act, New Hampshire Revised Statutes Annotated, Chapter 356-B, now and as hereafter may be amended. .

**ARTICLE 1
SUBMISSION OF PROPERTY**

The Declarant hereby submits land located in the City of Portsmouth, Rockingham County, New Hampshire, consisting of approximately ____ acres, more or less, situated on the westerly side of Banfield Road, and more particularly described in **Exhibit A** hereto (“Land”), together with the buildings and other improvements heretofore or hereafter constructed thereon, and all easements, rights and appurtenances thereto described in said **Exhibit A**, or as shown on plans of said land, all of which are owned by the Declarant, to the provisions of the Condominium Act, in order to create a plan of condominium ownership in such property containing up to twenty two (22) units, as shown on the following plan; See plan of land entitled, “Condominium Site Plan,” project for “Banfield Woods, Banfield Road, Portsmouth, New Hampshire 03801” prepared by TF Moran, Inc. **dated** _____ **and recorded in the Rockingham County Registry of Deeds as Plan #D-_____.**

**ARTICLE 2
DEFINITIONS**

As provided in Section 12, I of the Condominium Act capitalized terms not otherwise defined in this Declaration or in the Bylaws attached hereto as Exhibit B, as amended from time to time, shall have the meanings specified in Section 3 of the Condominium Act. The following terms are expressly defined herein:

(a) "Building" means any building constructed on a Unit or on the Limited Common Area assigned to a Unit as permitted herein, which Buildings shall be owned by the Unit Owner of the Unit.

(b) "Bylaws" mean the Bylaws provided for the self-government of the Condominium attached hereto, as amended from time to time.

(c) "Common Area" means all parts of the Property other than the Units, as more fully set forth in Article 5 of this Declaration and in the Site Plans and includes the Limited Common Area.

(d) "Common Expenses" means and includes the actual and estimated expenses of operating the Association, all as may be found to be necessary and appropriate by the Board pursuant to this Declaration and the By-Laws and shall specifically include all of these expenses for which the Association is responsible under the Stormwater Management Operation and Maintenance Manual attached hereto as Exhibit A,.

(e) "Condominium" means "Banfield Woods Condominium", the condominium established by this Declaration.

(f) "Condominium Act" means Chapter 356-B of the New Hampshire Revised Statutes Annotated, as amended.

(g) "Condominium Plan" or "Plans" or "Plat" means the plan entitled Condominium Site Plan," project for, "Banfield Woods, Banfield Road, Portsmouth, NH 03811," prepared by TF Moran, Inc. **dated _ and recorded in the Rockingham County Registry of Deeds as Plan #D-_____**, and any revisions thereof, recorded in the Registry simultaneously herewith or recorded subsequently pursuant to the Condominium Act, and any updated or amended site or floor plans.

(h) "Limited Common Area" means all those certain portions of the Common Area which are assigned to each Unit, 15 feet on either side of each unit, 30 feet behind each unit and 20 feet in front of each unit, or to the edge of pavement, whichever is less. Such Limited Common Area shall be restricted for use by the owner(s) of each such Unit, as more fully set forth in this Declaration and in the Plans, and additional limited common area as Declarant may determine in the future.

(i) "Majority of the Owners" means the Owners of the Units to which more than fifty one percent (51%) of the votes in the Unit Owners' Association appertain. Any specified percentage of the Owners means the Owners of Units to which the specified percentage of the votes in the Unit Owners' Association appertain.

(j) "Owner" or "Unit Owner" means any Person or Persons who holds or hold fee simple title to a Unit. No mortgagee shall be deemed to be an Owner until such mortgagee has acquired such title pursuant to foreclosure or any procedure in lieu of foreclosure.

(k) "Percentage Interest" or "Undivided Percentage Interest" means the interest of each Unit in the Common Area as set forth in **Exhibit E** of this Declaration and as may be amended hereafter, which may be expressed as a fraction.

(l) "Registry" means the Rockingham County Registry of Deeds, or any then applicable real property recording office.

(m) "Property" means the Land and the buildings and all other improvements heretofore and hereafter constructed thereon, and all easements, rights and appurtenances thereto, and all articles of personal property intended for common use in connection therewith which are submitted to the Condominium by this Declaration, as amended from time to time.

(n) "Rules" means those rules and regulations adopted from time to time by the Association relative to the use of the Condominium, provided they are not in conflict with the condominium Act, the Declaration or the Bylaws, the City of Portsmouth Zoning Ordinance and the conditions on the plat approved by the Planning Board.

(o) "Site Plan" means the plat of the land submitted to the Condominium Act by this Declaration, which plat is being recorded in the Registry simultaneously herewith. Such term shall include, as appropriate, any such plat recorded in the Registry: (i) subsequently pursuant to RSA 356-B: 20, III, and 356-B:21 or any other provisions of the Condominium Act, or (ii) subsequently for the purpose of amending any previously recorded plat, as the case may be.

(p) "Unit" means a unit as defined by the Condominium Act, which is bounded and described (i) as shown on the Condominium Site Plan; (ii) Floor Plan; and (iii) as provided in Article 4, below.

(q) "Unit Owners' Association" or "Association" means all of the Owners acting as a group in accordance with this Declaration and Bylaws.

**ARTICLE 3
STATUTORY REQUIREMENTS**

The following information is provided pursuant to the provisions of the Condominium Act:

(a) Name: The name of the Condominium is "Banfield Woods Condominium."

(b) Location: The Condominium is located on Banfield Road, City of Portsmouth, Rockingham County, New Hampshire.

ARTICLE 4

DIVISION OF PROPERTY

The property, together with all buildings and improvements thereon, is hereby divided into twenty two (22) separate freehold condominium units, hereinafter referred to as Units #1, #2, #3, #4, #5, #6, #7, #8, #9, #10, #11, #12, #13, #14, #15, #16, #17, #18, #19, #20, #21 and #22,. The layout, numerical designation, dimensions, and area of each Unit are shown on the Condominium Site Plan.

A. The boundaries of the Units are defined as follows:

The Units shall be Land Units, the vertical boundaries being coextensive with the area identified as such Unit on the Site Plan and the horizontal boundaries being from the center of the earth to the upper edge of the atmosphere and includes the entirety of any building or addition to buildings or improvements to be constructed on the land and includes all rights above the land and any existing building and improvements or any building or improvements constructed within the Land Unit. For the purposes of RSA 356-B, the Condominium Plan shall serve as the Floor Plan for each Land Unit declared herein. In the event a building is constructed within the Land Unit, upon completion of the foundation, a Floor Plan, certified as required by RSA 356-B:20 shall also be recorded, provided the boundary of the Land Unit shall remain the unit boundary.

ARTICLE 5 DESCRIPTION OF COMMON AREAS

Common Areas are set forth on the Condominium Plan Common Areas include, but are not limited to, the following:

SECTION A. All open space, common utilities, walkways, and paths.

SECTION B. All roadways servicing the Condominium and shown on the Plat shall be private and shall be maintained as Common Area by the Association.

ARTICLE 6 DESCRIPTION OF LIMITED COMMON AREA

Limited Common Area (herein "LCA") is defined as a portion of the Common Area which has been reserved for the exclusive use of the specific Unit or Units to which the Limited Common Area is assigned.

Limited Common Area shall be assigned as set forth in these Condominium Instruments. The "Condominium Instruments" is a term collectively referring to the Declaration, the By-Laws, and the Condominium Site Plan, and the building envelopes depicted on the Condominium Site Plan and recorded pursuant to the provisions of the Condominium Act. To the extent there is a conflict within the Condominium Instruments regarding the assignment of

the Limited Common Area to a specific Unit, the assignment of Limited Common Area as set forth on the Condominium Plan shall control.

Reassignment of the LCA is expressly permitted if the reassignment complies with the Condominium Instruments and RSA 356-B, as amended. However, LCA may not be reassigned without the express written permission of the Unit Owner(s) who possesses the exclusive use of the LCA. Any reassignment of the LCA must be recorded in the Rockingham Registry of Deeds to be effective.

It is the intention of the Declarant that the following portions of the Common Area shall be exclusively assigned as LCA:

1. The land shown on the Condominium Plan and which includes the septic system serving the appurtenant units and the appurtenant driveways.
2. All piping, wiring, cable, facilities, improvements, utilities, propane tanks, septic tank or other portions of the Common Area contained within any Limited Common Area shall be exclusively assigned to such appurtenant Units, except the piping, duct work or other improvements which serve the condominium as a whole.

SECTION A. Subject to the restrictions, easements, covenants, conditions, and terms set forth in these Condominium Instruments, the Condominium Act, the ordinance of the City of Portsmouth, and any documents of record, the Owner of the Unit which possesses the assignment and exclusive use of Limited Common Area shall be permitted to encroach upon, use and possess the Limited Common Area. The Declarant shall provide for lawn mowing and landscape maintenance, operation and maintenance of the septic systems, driveway plowing, and walkway snow shoveling within the Limited Common Areas and Unit (collectively referred to as "Maintenance"). The Board of Directors shall be responsible for the Maintenance when it takes control of the Association.

The exterior of Units shall be kept in good repair by the Unit Owner and maintained to the aesthetic and repair standards set forth in this Declaration and By-Laws. Failure of a Unit owner to maintain its Unit to such standards shall give cause to the Association to enter the Limited Common Area to effectuate such repairs or maintenance and to invoice the Unit Owner for the expense thereof.

SECTION B. The LCA, including any improvements or developments, shall run with and be appurtenant to the Unit to which it is assigned and shall automatically pass with the title to the Unit whether or not the LCA is expressly conveyed.

ARTICLE 7
ALLOCATION OF UNDIVIDED INTERESTS ("COMMON INTERESTS")

There is hereby allocated to each Unit an undivided interest in the Common Areas as set forth on **Exhibit E** attached hereto and made a part hereof, under the column "Common Interest". Said undivided interest appurtenant to each Unit is herein called the "common

interest". The interest appurtenant to each Unit are shown on **Exhibit E**. The common interest appurtenant to each Unit will have a permanent character and shall not be altered without the consent of the owner of each Unit affected thereby. The common interest appurtenant to each Unit will not be separated from said Unit even though not expressly mentioned or described in the conveyance or other instrument. The Common Areas will remain equal and undivided and no right shall exist to partition or divide any part thereof except as may be provided in the New Hampshire Condominium Law.

ARTICLE 8

PARKING

Subject to regulation by the Association of Unit Owners (as set forth in the Condominium By-Laws to be recorded with this Declaration as well as Rules and Regulations to be adopted) the Unit owners shall have the exclusive right to park vehicles in the portion of the Limited Common Area associated with his/her Unit as shown on the Plan.

ARTICLE 9

EASEMENTS

SECTION A. Each Unit shall have appurtenant thereto non-exclusive easements in the Common Areas designed for such purposes for ingress to, egress from, and utility services for such Unit, and in the other Common Areas for their use according to their respective purposes, subject always to the exclusive or limited use of the Limited Common Areas as herein provided. These non-exclusive easement rights include, but are not limited to, the right to for the purposes of maintenance or repair of same and any Common Area. If any Unit or Common Area encroaches on any other Unit or Common Area, a valid easement for such encroachment and the maintenance and use thereof so long as it continues shall exist.

SECTION B. To the extent permitted by New Hampshire Revised Statutes Annotated Section 356-B:42 II, as amended from time to time or any successor statute, the Association of Unit Owners shall have the irrevocable power as attorney in fact on behalf of all of the Unit Owners and their successors in title to grant easements through the Common Areas and accept easements benefiting the condominium or any portion thereof;

SECTION C. Declarant hereby expressly reserves the right to grant easements to the owners of abutting property, as well as to the City of Portsmouth, private utilities, electric utilities or gas line utilities, telephone utilities or cable utilities, and any other utilities over, under and through the common and Limited Common Areas of the Condominium for whatever use may be made thereof.

ARTICLE 10
STATEMENT OF PURPOSES, USE, AND RESTRICTIONS.

The Units, Common Areas, and Limited Common Areas shall be occupied subject to the following rules and restrictions:

SECTION A. The Declarant shall have the right to transact any business on the Condominium property necessary to consummate sales of Condominium units; including, but not limited to the right to maintain models, having signs identifying units, maintaining employees in the offices, use of the Common Areas and facilities on the Condominium property, and to show units for sale. All furniture and furnishings and equipment in the model units, signs, and all items pertaining to sales shall not be considered Common Areas and facilities and shall remain the property of the Declarant. In the event there are unsold Condominium units, Declarant's right as the owner of said unsold units shall be the same as all other unit owners in the Condominium; and the Declarant, as the owner of the Condominium units, shall contribute the common expenses in the same manner as other Condominium unit owners once an Occupancy Permit has been issued and the Declarant, as the owner of the Condominium units, shall have a vote in the Association for each unsold Condominium unit.

SECTION B. None of the twenty (22) residential units shall be used for any purpose except residential purposes.

SECTION C. Nothing shall be done or kept in any unit or in the Common Areas or Limited Common Areas, which will increase the rate of insurance in those areas without the prior written consent of the Owners' Association. No owner shall permit anything to be done or kept in his Unit or in the Common Areas or Limited Common Areas which will result in the cancellation of insurance of any unit or any part of the Common Areas or Limited Common Areas, which would be in violation of any law. No waste will be permitted in the Common Areas or the Limited Common Areas.

SECTION D. Units shall be used solely for residential purposes and for uses accessory thereto as may be permitted from time to time by the zoning ordinances of the City of Portsmouth. Notwithstanding the restrictions of this paragraph, the Declarant and its successors in interest may, until all of the residential Units shall have been sold by the Declarant or such successor(s), use unsold Units as models for purposes of promoting the sale or leasing of Units.

SECTION E. .

(1) All buildings and structures shall be architecturally designed in keeping with traditional styles as determined by the Declarant. The Declarant, at Declarant's sole discretion, subject to federal, state, and/or municipal approvals, if applicable, reserves the right to approve the plans and specifications of all residences and other structures for as long as the Declarant is the owner of any Unit in the condominium. At such time as the Declarant relinquishes its control to the Association, the responsibility and/or authority for any architectural approvals in accordance with the Declaration and By-Laws shall become the responsibility of the Board of Directors of the Association or any subcommittee of the Association appointed to perform that

task. The Declarant reserves the right to turn over responsibility for architectural approvals to the Association at any time prior to its conveyance of the last Unit it owns.

(2) No construction of any kind shall be commenced on any Unit nor shall any exterior addition or change or alteration be made to any structure nor shall utility lines be erected or installed until plans for the foregoing have been approved in writing by the Declarant at Declarant's sole discretion, subject to federal, state, and/or municipal approvals, if applicable. A copy of such plans shall be provided to the Association for its records. Without limiting the generality of the foregoing, all renovations, including the painting, repairing and replacing of exterior doors, door frames, windows, window frames, roofs, siding, porches, decks, entries and other exterior features of the buildings shall be subject to the review and approval of the Board of Directors or its subcommittee established for this purpose prior to commencement of the work

(3) The architectural integrity of the buildings and the Units shall be preserved, and to that end, no awnings, antennas, and no exterior change, addition, structure, projection, decoration or other feature which is visible from the exterior of a Unit, shall be erected or placed upon or attached to the buildings or any Unit, or any part of either, unless previously approved by the Declarant, at Declarant's sole discretion, subject to federal, state, and/or municipal approvals, if applicable. This subparagraph, however, shall not restrict the right of the Owner(s) of each Unit to decorate the interiors of the Unit as said Owner(s) may desire.

Commented [JB1]: Already addressed above.

SECTION F. No animals, livestock, or poultry of any kind shall be raised, bred, or kept in any unit or in any of the Common Areas or Limited Common Areas without the express written permission of the Board of Directors. Pets shall be allowed only with the written permission of the Board of Directors and such permission may be withdrawn should the pets become a nuisance to other unit owners. Owners shall strictly comply with all rules and regulations concerning pets as may be adopted by the Association. No exotic pets are allowed. Pets shall be kept under control of their owners at all times and shall not be allowed to run loose except in the presence and under the control of their owner. The board of directors may make further provisions in the Rules for the control and regulation of household pets on the property. The owner of a unit where a pet is kept or maintained shall be responsible for the maintenance of said pet, and any costs incurred by the association in enforcing the rules prescribed or to be prescribed by the Board of Directors for the control and regulation of pets and each such owner, by electing to keep a pet, shall be deemed to indemnify and hold the Board harmless against such loss or liability resulting from said pet. Owner shall comply with all town ordinances related to pets and pet laws.

SECTION G. The Declarant has adopted and the Association Board may amend from time to time detailed rules and regulations for the use and enjoyment of the Common Areas, for avoiding noxious or offensive activity which may disturb the occupants of any Unit, and for the occupants of any Unit, and for the general governing of the Condominium, consistent with, and not in conflict with, this Declaration and the Bylaws. All Owners and their tenants, guests and licensees will strictly comply with said rules and regulations.

SECTION H. Units may be rented. All rental agreements shall be documented by a written lease for a term of not less than six (6) months. The lease shall be subject to the Declaration, Bylaws and Rules and Regulations of the Condominium.

SECTION I. The Declarant shall be responsible for arranging stormwater and drainage system monitoring and maintenance, septic system monitoring and maintenance, wetland buffer monitoring, snow removal and lawn mowing within the Common Areas and Limited Common Areas as a Common Expense. Each owner shall be responsible to maintain his unit so as not to interfere or obstruct with the operation of the stormwater drainage system.

SECTION J. Declarant reserves the right to make use of unsold Units as may facilitate the completion, construction or sale of the Condominium, including the right to enter all Units, and Limited Common Areas, upon reasonable notice to the Owner thereof, or Common Areas for construction purposes. Declarant reserves the right to store materials, to maintain a sales office or a rental office in any unsold Units, to show such Units for sale or lease, and to display appropriate signs, at Declarant's sole discretion, in conjunction therewith, on unsold buildings or building envelopes, and has the right to implement any other marketing signage anywhere in the entire development.

SECTION K. . No sign of any kind, towels, blankets, or laundry of any kind, shall be displayed to the public view on or from any unit without the prior written consent of the Board of Directors. No commercial or advertising signs of any kind shall be erected, placed, permitted or maintained on any common area or limited common area or improvement except such signs as may be approved by the Association for the operation of the condominium or for the sale of Units within the condominium. Declarant shall be permitted, at Declarant's sole discretion, to place signs advertising the sale or lease of units, along with development signage, entrance way signage, directional and temporary signage. Display of the United States Flag shall be regulated by RSA 356-B:47-a and rules and regulations adopted thereunder by the Owners' Association and any applicable Zoning and Planning Regulations of the City of Portsmouth.

SECTION L. . Mobile homes or structures of any kind or character, whether temporary or otherwise, shall not be permitted on any common area or limited common area. However, Declarant, at Declarant's sole discretion, may maintain a trailer for development purposes.

SECTION M. No commercial vehicles, pleasure or commercial boats or vessels of any kind, motor homes, campers, trailers, school buses, all-terrain vehicles, off road vehicles or snow mobiles shall be used in the condominium nor shall they be stored within the common area or limited common area, including, but not limited to parking areas and trails. Golf carts may be allowed on the premises subject to the approval of the Declarant, at Declarant's sole discretion, and subject to the approval of the Association after the Declarant relinquishes control. None of the above referenced vehicles may be kept on the premises except out of sight of the roadway, behind the structure or properly screened from the roadway and abutters or if the same be kept stored in a garage or outbuilding conforming to these covenants. Unregistered or uninspected automobiles or automobiles being repaired, refinished, restored, or otherwise brought onto the premises for a period of more than seven (7) days shall be stored in a garage or other enclosed structure.

SECTION N. . Only the Declarant shall be permitted to cut trees on the property. No unit owner shall be permitted to cut any tree(s) without the express written permission of the Declarant. All clearing shall comply with the City of Portsmouth's land use regulations and ordinances.

SECTION O. No noxious or offensive activities shall be carried on in any unit or in the Common Areas or Limited Common Areas, nor shall anything be done therein which may become an annoyance or nuisance to the other unit owners.

SECTION P. There shall be no violation of the rules of the use of the units, Common Area, or Limited Common Area as adopted by the Owners' Association and furnished in writing to the owners. The Declarant, until such time as the Owners' Association is formed, and thereafter the Owners' Association are authorized to adopt such rules.

SECTION Q. Insofar as may be necessary, the Declarant and persons that they may select shall have the right of ingress and egress over, upon, and across the Common Area and Limited Common Area and the right to store materials thereon and to make such other use thereof as may be reasonable, necessary, and incidental to construction and complete development and sale of the project, but the Declarant and the persons to whom he has granted this permission shall not unduly interfere with the unit owners or persons living in the units and their rights to use the Common Area and Limited Common Area and facilities.

SECTION R. No unit owner shall paint or otherwise decorate or change the appearance or the type of exterior siding of any portion of the exterior of his/her unit.

SECTION S. No unit owner shall make any alterations to his/her unit; provided, however, any unit owner shall have the right to make interior decorating improvements or any interior changes which do not affect any facilities, which are shared with the other units.

SECTION T. . The following are prohibited:

- (1) Clotheslines;
- (2) Above ground swimming pools;
- (3) Antennas or satellite dishes with diameters larger than 24 inches;
- (4) Additions or outbuildings or appurtenances unless prior approval has been obtained;
- (5) Any basketball hoops, soccer nets or other personal property in the right-of-way;

**ARTICLE 11
OPEN SPACE**

The Declarant, or its successors and assigns, covenant that the “Open Space” as depicted on the Condominium Site Plan, is and shall forever be and remain subject to the following covenants and restrictions:

(a) The purpose of the Open Space after completion of the proposed improvements depicted on the Condominium Site Plan is to retain the area in its scenic and open space;

(c) It shall be maintained in perpetuity as open space.

(f) Upon completion of the proposed improvements, no filling or excavation of soil or other alteration of topography or cutting or removal of standing trees shall be allowed, except those that present an imminent threat to person or property. In addition, trees may be removed in accordance with accepted silvicultural forest practices as outlined in the publication entitled Good Forestry Practices in the Granite State by the Society for the Protection of NH Forests. No disturbance of other natural features shall be allowed unless such activities are commonly necessary to maintain the existing natural environment of the open space.

(g) There shall be no dumping or depositing of trash, debris, stumps, yard waste, hazardous fluid or materials, vehicle bodies or parts within the Open Space.

(h) No discharge of firearms or shooting with a bow and arrow or trapping of animals shall be permitted upon the Open Space in violation of RSA 207:3-a, as amended.

(i) The “Open Space” comprises a portion of the Common Area of the Condominium. As such, maintenance, if any, in the Open Space will be performed pursuant to the other provisions of this Declaration and the Bylaws. Costs for the maintenance, monitoring and annual reporting of the Open Space will be treated as a Common Expense and paid by the Unit Owners in accordance with the provisions of this Declaration.

(j) Such reasonable rules and regulations as may from time to time be promulgated by the Condominium Association for “open space recreational uses.”

(m) Acceptance of any deed for any Unit within the condominium constitutes acknowledgment by the purchaser of the existence of these restrictions and agreement to be bound by it and that said purchaser will not take any action which might violate any provision hereof.

(n) The Declarant, its successors or assigns, reserve the right to perform cutting, grading, planting and seeding on the common area or limited common area for construction and to install and maintain drainage structures as needed in the development of the condominium.

(o) The Declarant, its successors or assigns, reserve the right to grant utility easements on the common area or limited common area to install and maintain utilities as needed in the development of the condominium.

(p) Dead, diseased, unsafe, or fallen trees, saplings, shrubs, and ground cover may be removed by the Declarant, its successors or assigns.

ARTICLE 12

. STORMWATER MANAGEMENT, SEPTIC, WETLANDS

(a) The Association will monitor and maintain the storm water systems contained in the Condominium.

(b) The Association will be responsible for and shall monitor and maintain the septic systems within the Association according to acceptable Best Practices for septic system maintenance and care.

(c) The Declarant will mark the wetland buffer by affixing Conservation/Buffer medallions on the trees at the perimeter of the wetland buffer to make all Condominium Owners and Guest aware of the wetland buffer. The wetland buffer is governed by Article 10 of the Portsmouth Zoning Ordinance and more specifically Article 10.1014.20, titled "Wetland Buffers. The purpose of a wetland buffer is to reduce erosion and sedimentation into the adjacent wetland, vernal pool or water body, to aid in the control of nonpoint source pollution, to provide a vegetative cover for filtration of runoff, to protect wildlife habitat, and to help preserve ecological balance.

ARTICLE 13

ENFORCEMENT OF RESTRICTIONS

If any person or entity shall violate or attempt to violate any of the rules or restrictions set forth in this Declaration, in the By-Laws or in any rules or regulations adopted by the Association of Unit Owners, the Association may commence legal action against said person or entity or against the owner(s) of any Units within which such violation are occurring, either to prevent or abate such violation, or to recover damages caused by such violation or both. In the event of a successful prosecution, the Association of Unit Owners will be entitled to receive its costs, including reasonable attorney's fees, as part of its judgment against the defendant.

If the Association of Unit Owners shall fail to enforce this or any one or more of the covenants set forth in this Declaration or any rule contained in the By-Laws or any rules of the Association of Unit Owners after receiving written request to do so from any Unit Owner within the condominium, then any such Unit Owner may attempt to enforce said requirements by giving ten (10) days' prior written notice to the person violating them, followed by legal proceedings

either to enjoin the violation or to recover damages or other compensation, including reasonable collection costs and attorney's fees if the court deems it appropriate under the circumstances.

Notwithstanding anything in this Declaration or in the By-Laws to the contrary, no Unit Owner shall be liable for any violations except such as occur during his or her Unit ownership.

ARTICLE 14 INSURANCE

1. Insurance Required. Pursuant to Section 43 of the Condominium Act, the Board of Directors shall obtain (i) a master casualty policy affording fire and extended coverage in an amount equal to the full replacement value of the common structures within the Condominium; (ii) a master liability policy covering the Association, the Board, the Manager and agents or employees of the foregoing with respect to the Condominium, and all Owners and other persons entitled to occupy any portion of the Condominium; and (iii) such other policies as specified hereinbelow; which insurance shall be governed by the following provisions to the extent obtainable or possible:

(a) Fire insurance with standard extended coverage endorsement, vandalism and malicious mischief endorsements insuring all the common buildings in the Condominium including without limitation all portions of the interior of such buildings are for insurance purposes normally deemed to constitute part of the building and customarily covered by such insurance, such as heating and air conditioning and other service machinery, interior walls, all finished wall surfaces, ceiling and floor surfaces including any wall to wall floor coverings, bathroom and kitchen cabinets and heating and lighting fixtures, except for improvements which exceed a total value of One Thousand Dollars (\$1,000.00) and are not reported to the insurer, such insurance to be in an amount at least equal to the replacement value of the buildings and to be payable to the board as trustee for the Owners and their mortgagees as their respective interests may appear.

(b) Public liability insurance in such amounts as the Board may from time to time determine, but in no event shall the limits of liability be less than One Million Dollars (\$1,000,000.00) for bodily injury and property damage per occurrence, insuring the Association and all individuals referred to in Section I (ii) above, against any liability to anyone, and with cross liability coverage with respect to liability claims of anyone insured thereunder against any other insured thereunder. The insurance, however, shall not insure against individual liability for negligence occurring within a Unit or within the Limited Common Area to which a Unit has exclusive use.

c) Workmen's compensation insurance as required by law.

d) Such other insurance as the Board may determine.

2. General Insurance Provisions.

(a) The Board shall deal with the insurer or insurance agent in connection with the adjusting of all claims under insurance policies provided for under Paragraph 1 above and shall

review with the insurer or insurance agent, at least annually, the coverage under said policies, said review to include an appraisal of improvements within the Condominium, and shall make any necessary changes in the policy provided for under Paragraph 1 (a) above (prior to the expiration date set forth in any agreed amount endorsement contained in said policy) in order to meet the coverage requirements of such Paragraph.

(b) The Board shall be required to make every effort to see that all policies of physical damage insurance provide for under Paragraph 1 above : (i) shall contain waivers of subrogation by the insurer as to claims against the Association, its employees and agents, members of the Board, the Manager, Owners and members of the family of any Owner who reside with said Owner, except in cases of arson and fraud; (ii) shall contain a waiver of defense of invalidity or prejudice on account of the conduct of any of the Owners over which the Association has “no control”; (iii) shall contain a waiver of defense of invalidity or prejudice by failure of the insured, or Owners collectively, to comply with any warranty or condition with regard to any portion of the Condominium over which the insured, or Owners collectively, have no control; (iv) shall provide that such policies may not be canceled or substantially modified without at least thirty (30) days written notice to all of the insureds thereunder and all mortgagees of Units in the Condominium; (v) shall provide that in no event shall the insurance under said policies be brought into contribution with insurance purchased individually by Owners or their mortgagees; (vi) shall exclude policies obtained by individual Owners for consideration under any “no other insurance” clause; and (vii) shall provide that until the expiration of thirty (30) days after the insurer gives notice in writing to the mortgagee of any Unit, the mortgagee’s insurance coverage will not be affected or jeopardized by any act or conduct of the Owner of such Unit, the other Owners, the Board of Directors, or any of their agents, employees or household members, nor canceled for non-payment of premiums.

3. Individual Policies. All Owners shall obtain, at his own expense, insurance insuring his own unit and all buildings thereon and insurance against loss or damage to personal property used or incidental to the occupancy of the Unit, additional living expense, vandalism or malicious mischief, theft, personal liability and the like.

(a) Each Owner shall obtain additional insurance for his own benefit and at his own expense. No such policy shall be written so as to decrease the coverage under any of the policies obtained by the Board pursuant to paragraph 1(a) above, and each Owner hereby assigns to the Board the proceeds to be applied pursuant to the terms hereof as if produced by such coverage. Copies of all such policies (except policies covering only personal property, owned, or supplied by individual Owners) shall be filed with the Association.

(b) Each Owner shall obtain insurance for his own benefit and at his own expense insuring all personal property presently or hereafter located in his Unit or Limited Common Area, any floor coverings, appliances and other personal property not covered in the master policy, and any insurance deductible that the unit may be assessed and all improvements.

(c) Each Owner, prior to commencement of construction of such improvements, shall notify the Board of all improvements to his Unit (except personal property other than fixtures) which exceed a total value of One Thousand Dollars (\$1,000.00).

(d) Each Owner shall obtain liability insurance with respect to his ownership and/or use of his Unit.

4. Notice to Unit Owners. When any policy of insurance has been obtained on behalf of the Association, written notice of the obtainment thereof and of any subsequent changes therein or termination thereof shall be promptly furnished to each Unit Owner by the Secretary of the Association. Such notice shall be sent by U.S. Mail, return receipt requested, to all Unit Owners of record at the address of their respective Units and to such other addresses as any of them may have designated to the Secretary; or such notice may be hand delivered by the Secretary or Manager obtains a receipt of acceptance of such notice from the Unit Owner.

ARTICLE 15 CONDEMNATION

If part of the project shall be taken or condemned by any authority having the power of eminent domain such that no Unit or any part thereof is taken, then all compensation and damages for on account of the taking or the common elements, exclusive of compensation for consequential damages to certain affected Units, shall be payable to the President of the Association as Trustee for all Unit Owners and Mortgagees according to the loss or damage to their respective interests in such common elements. The Association shall have the right to act on behalf of the Unit Owners with respect to all issues related to the taking and compensation affecting the common elements. Such proceeds shall, subject to the prior rights of such mortgagees, become a part of the reserve funds of the Association.

If any Unit or a part thereof is taken, the Unit Owners directly affected by such taking and their respective mortgagees shall represent and negotiate for themselves with respect to the damages affecting their respective Units. The awards so made shall, subject to the prior rights of mortgagees, be used and distributed by the Trustee first to restore the Units on the remaining land of the project in the same manner as provided for restoration under Section 13 hereof to the extent possible, attempting to rebuild the building, containing new units of the same number, size and basic plan as the units taken, with any excess award distributed in accordance with the provisions of this section.

ARTICLE 16 REVIEW OF INSURANCE

The Association will review not less frequently than annually the adequacy of its insurance program and will, if requested by Unit Owners report to each Unit Owner in writing the Association's conclusions and actions taken, from time to time. Such review shall include an appraisal of all improvements to the project by a representative of the insurance carrier writing the Master Policy. Also, the Association shall provide each Unit Owner with notices describing each new policy of insurance and all amendments and terminations thereof, as and when occurring, in the same manner as it provides notices of Association meetings as set forth in the By-Laws, all as required by New Hampshire Revised Statutes Annotated, Section 356-B:43 II, or any successor statute.

**ARTICLE 17
AMENDMENTS TO THE CONDOMINIUM AND TERMINATION**

This Declaration, the By-Laws, the Floor Plan, the Condominium Plan or any other condominium instruments (as defined by New Hampshire Revised Statutes Annotated Chapter 356-B) may be amended from time to time, or this condominium may be terminated, only in strict compliance with New Hampshire Revised Statutes Annotated Section 356-B:34, as amended from time to time, or any successor statute. In no event shall such amendments be made without the consent of at least 2/3 of the Unit Owners.

**ARTICLE 18
DEFINITIONS**

All terms and expressions used in this Declaration which are defined in New Hampshire Revised Statutes Annotated Chapter 356-B shall have the same meanings here unless the context otherwise requires.

**ARTICLE 19
PARTIAL INVALIDITY**

The invalidity of any provision of this Declaration shall not impair or affect the validity of the remainder of this Declaration and all valid provisions shall remain enforceable and in effect notwithstanding such invalidity.

**ARTICLE 20
MORTGAGES**

1. Notice to Board. An Owner who mortgages his Condominium Unit shall notify the Board of the name and address of his mortgagee, and shall file a conformed copy of the mortgage with the Board. The Board shall maintain suitable records pertaining to such mortgages.

2. Notice of Action. Upon written request to the Unit Owners' Association, identifying the name and address of the holder, insurer or guarantor and the Unit number or address, any such Eligible Mortgage Holder or Eligible Insurer or Guarantor will be entitled to timely written notice of:

(a) Any condemnation loss or any casualty loss which affects a material portion of the Condominium or any Unit on which there is a first mortgage held, insured, or guaranteed by such Eligible Mortgage holder or Eligible Insurer or Guarantor, as applicable;

(b) Any delinquency in the payment of assessments or charges owed by an Owner of a Unit subject to a first mortgage held, insured or guaranteed by such Eligible

Mortgage Holder or Eligible Insurer or Guarantor, which remains uncured for a period of 60 days.

(c) Any lapse, cancellation or material modification of any insurance policy or fidelity bond maintained by the Owners' Association;

(d) Any proposed action which the Declaration, these Bylaws or the Condominium Act, requires the consent of a specified percentage of mortgage holders.

3. Notice of Default. The Board shall give written notice to an owner of any default by the Owner in the performance of any obligations under the Act, Declaration or Bylaws and, if such default is not cured within thirty (30) days, shall send a copy of such notice to each holder of a mortgage covering such Unit whose name and address has theretofore been furnished to the Board. No suit or other proceeding may be brought to foreclose the lien for any assessment levied pursuant to the Declaration or these Bylaws except after ten (10) days written notice to the holder of the first mortgage on the Unit which is the subject matter of such suit or proceeding.

4. Notice of Damage. The Board of Directors shall notify (i) the mortgagee of a Unit whenever damage to the Unit covered by the mortgage exceeds One Thousand Dollars (\$1,000.00) and the Board is made aware of such damage; and (ii) all the mortgagees whenever damage to the Common Area exceeds Ten Thousand Dollars (\$10,000.00).

5. Examination of Books. Each Owner and each mortgagee shall be permitted to examine the books on account of the Condominium at reasonable times, on business days, but, with respect to Owners, not more often than once a month.

DECLARATION OF THE BANFIELD WOODS CONDOMINIUM EXECUTED as of the day and year first above written.

GREEN & CO BUILDING AND DEVELOPMENT CO, INC.

Witness

By: _____
Richard W. Green, President
Duly Authorized

STATE OF NEW HAMPSHIRE
COUNTY OF ROCKINGHAM, ss.

This instrument was acknowledged before me on _____, 2020, by Richard W. Green, President of Green & Co Building and Development Co. Inc.

Notary Public
Printed Name: _____
My Commission Expires: _____

EXHIBIT A
LEGAL DESCRIPTION

EXHIBIT B
EXHIBIT C
CONVERTIBLE LAND

EXHIBIT D

EXHIBIT E
COMMON INTEREST

<u>Unit No.</u>	<u>Common Interest</u>
1	1/22
2	1/22
3	1/22
4	1/22
5	1/22
6	1/22
7	1/22
8	1/22
9	1/22
10	1/22
11	1/22
12	1/22
13	1/22
14	1/22
15	1/22
16	1/22
17	1/22
18	1/22
19	1/22
20	1/22
21	1/22
22	1/22

**BYLAWS
OF
BANFIELD WOODS CONDOMINIUM OWNERS ASSOCIATION**

1. PURPOSE AND DEFINITIONS

Purpose. The administration of Banfield Woods Condominium (the “Condominium”) shall be governed by these By-Laws which are annexed to the Declaration of Banfield Woods Condominium (the “Declaration”) and are made a part thereof.

Definitions. Certain of the terms used in these By-Laws have been defined in the Declaration and, when used herein, shall have the same meaning as set forth in the Declaration, unless the context clearly indicates a different meaning therefor.

Applicability of By-Laws. The provisions of these By-Laws are applicable to all of the property which now constitutes or hereafter may be added to the Condominium, and to the use and occupancy thereof.

2. MEMBERS AND MEETINGS

A. Members and Voting Rights. Each unit owner and the Declarant, until such time as all of the Declarant’s development rights have expired or been terminated (each an “Owner” and collectively the “Owners”) shall be a member of Banfield Woods Condominium Owner’s Association. The membership of the Association shall consist of all of the Owners. The Owner of each Unit shall be entitled to one (1) vote.

B. Transfer of Membership. Membership in the Association may be transferred only as an incident to the transfer of title to a Unit and shall become effective upon recordation of a deed of conveyance to the said Unit.

C. Annual Meeting. The annual meeting of the members shall be held on the second Monday of March, for the purpose of electing officers and for the transaction of such other business as may come before the meeting.

D. Regular Meetings. Regular meetings of the Board of Directors shall be held in accordance with the provisions of RSA 356-B: 37-c at such time and place as shall be determined, from time to time, by a majority of the directors, but at least quarterly meetings shall be held during each twelve month period after the annual meeting of the Unit Owners’ Association. Notice of regular meetings of the Board of Directors shall be posted to the community and given to each director, personally or by mail, e-mail, telephone or telegraph, at least five (5) business days prior to the day named for such meeting, except that no notice shall be required for a regular meeting held immediately after, and at the same place as the annual meeting of the Association. Directors may attend vote and participate at meetings by telephone or E-Mail pursuant to RSA 356-B:37-b. Pursuant to RSA 356-B:37-c (II) at least once per

quarter the Board shall hold open regular meeting to afford owners an opportunity to comment on any matter affecting the Association. Notice of the meeting and any materials distributed to the Board shall be available to the owner pursuant to RSA 356-B:37 (c) (III) and (IV).

E. Special Meetings. Special meetings of the Owners may be called at any time for the purpose of considering matters which, by the terms of the Declaration, these By-Laws, or the Condominium Act, (the "Act"), require the approval of the Owners, or for any other reasonable purposes. Special meetings shall be called by the President upon at least three (3) days written notice prior to the date of the meeting.

F. Contents of Notice. Pursuant to RSA 356-B:37 (I) and 356-B:37-a, it shall be the duty of the clerk or secretary, to send to all owners of record, at least twenty-one (21) days in advance of any meeting notice of any meeting. Said Notice shall state the time, place and purpose of the meeting and shall be sent to the unit owners at the addresses on file with the Association. The clerk or secretary shall attest that the notice was sent to the list of owners attached to the affidavit at the addresses on file with the association in the manner conforming with RSA 356-B: 37-a. Any such notice shall be deemed waived by any Owner who expressly waives the same in writing or who is present in person or by proxy at any such meeting.

G. Quorum. The presence in person or by proxy at the commencement of any meeting of the Association of Unit Owners of two thirds of the Unit Owners shall constitute a quorum at all meetings of the Unit Owners. In determining a quorum, the term "all Unit Owners" in this paragraph will not include Units the title of which is held by the Association. Pursuant to RSA 356-B: 38 (III) if a quorum is not met for an annual meeting, the board shall reschedule the meeting within sixty days and provide proper notice and proxies.

H. (1). Number of Directors and Initial Selection of Board. The Board of Directors shall be composed of three (3) persons. Until the election of the Board of Directors takes place at the first annual meeting of the Unit Owners' Association, the Board of Directors shall consist of such persons as shall have been designated by the Declarant. Thereafter, anything in these Bylaws to the contrary notwithstanding, until seven (7) years after the date of recordation of this Declaration, or until ninety percent (90%) of the Units have been conveyed by the Declarant, whichever occurs later, the members of the Board of Directors shall be selected and designated by the Declarant. The Declarant shall have the right in its sole discretion to replace such Directors as may be so selected and designated by it, and to select and designate their successors. The Declarant may relinquish its rights hereunder at any prior time. Directors shall consist only of Owners or spouses of Owners, or, where a Person which is an Owner is not a natural person, any natural person having authority to execute deeds in behalf of such person.

(2). Election and Term of Office. The initial Board of Directors shall be elected to staggered terms of one, two and three years. Thereafter, each Director shall serve a three (3) year term and one Director shall be elected at every annual meeting. At the expiration of the initial term of office of each director, his successor shall serve a term of three (3) years and each director shall hold office until his successor has been appointed or elected as appropriate.

I. Voting and Minutes. At any meeting of the Association, the Owners shall be entitled to cast their votes for each condominium unit owned as provided in the Declaration. The

majority vote of all Unit Owners shall be required to adopt decisions at any meeting of the Association. Any Owner may attend and vote at such meeting in person or by proxy. The provisions of the Condominium Act shall govern all votes (including proxy votes and the votes of units owned by more than one person) at meetings of the Association. Pursuant to RSA 356-B: 37 (VI) the Board of Directors shall make copies of the minutes of all meetings available to the unit owners within 60 days of the date of the meeting or 15 days of the date the minutes are approved by the Board whichever occurs first. The association may opt to provide the minutes electronically or post them on the association website in which case the owners shall be informed of the web address.

J. **Budget Ratification.** Pursuant to RSA 356-B:40-c (I) the board of directors shall annually adopt a budget for the unit owners' association for consideration by the unit owners at a meeting. The board of directors shall, within 30 days of adoption of the proposed budget, provide the owners a summary of the budget, including any reserves and a statement of the basis on which any reserves are calculated and funded. The board of directors shall set a date not less than 10 days or more than 60 days after providing the budget summary to consider the ratification of the budget. Unless at that meeting, 2/3 of all unit owners reject the budget the budget is ratified whether or not a quorum is present. If no budget is proposed or the proposed budget is rejected, the last budget ratified by the owners shall be in effect until a new budget is ratified by the owners. Pursuant to RSA 356-B:40-c (II) the board of directors at any time may propose a special assessment which shall be ratified by the owners. The assessment shall be in accordance with the provisions of RSA 356-B:40-c (III).

3. POWERS

Powers and Duties. The Association shall have all of the powers and responsibilities assigned by the New Hampshire Condominium Act, RSA 356-B, as amended from time to time or any successor statute. Without limiting the generality of the preceding sentence, the Association will have all of the powers and duties necessary for the administration of the affairs of the condominium. Said powers and duties shall include, but not be limited to, the following:

- A. Operation, care, upkeep, and maintenance of the common areas;
- B. The employment, dismissal and replacement of agents and employees to facilitate the operation, care, upkeep, and maintenance of the common areas;
- C. To make or cause to be made additional improvements on and as part of the common areas (subject to Article VII, Section 2 below);
- D. To acquire, hold, manage, convey, and encumber title to real property (including but not limited to condominium Units conveyed to or acquired by the Association) in the name of and on behalf of the Association;
- E. To grant easements through the common areas and to accept easements benefitting the condominium or any portion thereof;

F. The assessment and collection of the common expenses from the Unit Owners, and the enforcement of liens to secure unpaid assessments, pursuant to RSA Section 356-B:46, as amended from time to time, or any successor statute;

G. The adoption and amendment of rules and regulations covering the details of the operation and use of the condominium, the common areas or any portion thereof;

H. Opening of bank accounts on behalf of the Association and designating the signatories required for such accounts;

I. Obtaining and administering insurance for the condominium as set forth in the Declaration;

J. Repairing, restoring, or replacing common areas after damage or destruction, or as a result of eminent domain proceedings, as provided in the By-Laws;

K. Procuring legal and accounting services necessary or proper in the operation of the condominium or the enforcement of these By-Laws;

L. The assessment of costs or damages against any Unit Owner whose actions have proximately caused damages to the common areas;

M. Payment of any amount necessary to discharge any lien or encumbrance levied against the entire condominium or any part thereof which may in the opinion of the Association constitute a lien against the condominium or against the common areas, rather than merely against the interests of particular Unit Owners (where one or more Owners are responsible for the existence of such lien, they shall be jointly and severally liable for the cost of discharging it and the costs incurred by the Association by reason of said lien or liens);

N. All other powers granted by the Declaration or these By-Laws, permitted by law or enjoyed by associations of this kind.

4. OFFICERS

A. Officers. The officers of the Association shall be a president, a treasurer and a secretary, all of whom shall be appointed by the Unit Owners. Such other officers and assistant officers as may be deemed necessary may be appointed by the Association. Any two or more offices may be held by the same person. Pursuant to RSA 356-B:35 (II), the board of directors/officers shall have a fiduciary relationship to members of the unit owners' association.

B. Appointment and Term of Office. The officers of the Association shall be appointed at the annual meeting. If the appointment of officers shall not be made at such meeting, such appointment shall be made as soon thereafter as conveniently may be. Each officer shall hold office until his successor shall have been duly appointed and shall have qualified or until his death or until he shall resign or shall have been removed in the manner hereinafter provided.

C. Removal. Any officer or agent may be removed by the Association whenever, in its judgment, the best interests of the Association will be served thereby, but such removal shall be without prejudice to the contract rights, if any, of the person so removed. Appointment of an officer or agent shall not in and of itself create contract rights. Removal of officers or directors shall be by a vote held in accordance with RSA 356-B: 40-b.

D. Vacancies. A vacancy in any office because of death, resignation, removal, disqualification, or otherwise may be filled by the Association for the unexpired portion of the term.

E. President. The president shall be the principal executive officer of the Association and shall in general supervise and control all of the business and affairs of the corporation. He shall, when present, preside at all meetings of the unit owners at meetings of the Association. He may sign with the secretary or with any other proper officer of the Association, deeds, mortgages, bonds, contracts, or other instruments which the Association has authorized to be executed, except in cases where the signing and execution thereof shall be expressly delegated by the Association or by these bylaws to some other officer or agent of the Association, or which is required by law to be otherwise signed or executed; and in general shall perform all duties incident to the office of president and such other duties as may be prescribed by the Association from time to time.

F. The Secretary. The secretary shall: (a) keep the minutes of the proceedings of the annual meeting in one or more books provided for that purpose; (b) see that all notices are duly given in accordance with the provisions of these bylaws or as required by law; (c) be custodian of the Unit Owner records of the Association; (d) keep a register of the post office address of each Unit Owner which shall be furnished to the secretary by such Unit Owner; (e) have general charge of the books of the Association; and (f) in general perform all duties incident to the office of secretary and such other duties as from time to time may be assigned to him by the president or by the Association.

G. The Treasurer. The treasurer if any is appointed and, if none, then the president shall: (a) have charge and custody of and be responsible for all funds and securities of the Association; (b) receive and give receipts for monies due and payable to the Association from any source whatsoever and deposit all such monies in the name of the Association in such banks, trust companies, or other depositories as may be authorized by the Association; (c) in general perform all of the duties incident to the office of treasurer and such other duties as from time to time may be assigned to him by the president or by the Association.

H. Execution of Instruments. All checks, drafts, notes, deeds, acceptances, conveyances, contracts or other instruments shall be signed on behalf of the Association by such person or persons as shall be provided authority by general or special resolution of the Association or, in the absence of any such resolution applicable to such instrument, by the President and by the Treasurer.

5. INTERIM MANAGEMENT BY DECLARANT

From and after the date of the recording of these By-Laws, the Declarant shall exercise all powers and responsibilities assigned by these By-Laws, the Declaration and by the New Hampshire Condominium Act to the Association of Unit Owners, and the Officers until such time as it turns over said powers and responsibilities to the Unit Owners. Said transfer of said powers and responsibilities shall in no event occur later than the first to occur of (1) the time at which the Declarants have completed the passing of title to third party purchasers of Units to which are assigned a total of 90% of the undivided interest in the common areas, or (2) the expiration of seven (7) years from the date of the incorporation of the Association. No contract binding the Association of Unit Owners, or the Unit Owners as a group, which shall have been entered into during the period of Declarant's control as described in this Article shall be binding after the termination of the Declarant's control unless ratified or renewed with the consent or affirmative vote of Unit Owners of a majority of the Units in the Association of Unit Owners.

6. COMMON EXPENSES

A. Common Expenses. The Owner of each Unit shall be liable for and shall pay as and when assessed a share of common expenses in proportion to his or her common interest. Common expenses will include all charges, costs and expenses of every kind incurred by or on behalf of the Association for and in connection with the administration of the condominium, including without limitation all charges for taxes (except real property taxes or other such taxes which are or may hereafter be assessed separately on each Unit and the common interest appurtenant thereto or the personal property or any other interest of a Unit Owner) assessments, insurance, liability for loss or damage arising out of or in connection with the common areas or any fire, accident or nuisance thereon, the cost of repair, reinstatement, rebuilding and replacement of facilities in the common areas, wages, accounting and legal fees, management fees and all other necessary expenses of upkeep, maintenance, management and operation incurred on or for the common areas. The common expenses may also include such amount as the Association may deem proper to make up any deficit in the reserve. Common expenses will also include all common expense assessments against all Units, title to which is held by the Association.

B. Capital Improvements. Whenever in the judgment of the Association the common areas should be improved by new construction, any such new or replacement construction may be made by the Association only after obtaining approval of all Units. If such approval is so obtained, the cost thereof shall constitute a part of the common expenses.

C. Reserves. The Association shall assess as a common expense an amount or amounts on a monthly basis for the purpose of establishing and maintaining a general operating reserve and general replacement reserve, against anticipated future outlays for operations or for maintenance or replacement of facilities within the common areas or equipment or other property held by the Association in connection with the condominium. The size of any such reserve shall be reviewed at each annual meeting of the Association. The funds will be deposited in a responsible bank and may be intermingled with the Association's general operating account, or segregated in a separate account, in the Association's discretion.

Any such reserve may be used at the discretion of the Association to meet any deficiencies in operating funds from time to time resulting from higher than expected operating expenses and maintenance costs, or any delinquency by any Unit Owner or Owners in the payment of assessment for common expenses. Said reserve shall not operate to exempt any Owner from liability to contribute his or her proportionate share of such expenses or to pay any such assessments thereof and any funds withdrawn from said reserve for the purpose of making up any delinquency shall be reimbursed upon the payment of such delinquent assessments. The proportionate interest of each Owner in said reserve shall not be withdrawn or assigned separately but shall be deemed to be transferred with each Unit even though not mentioned or described expressly in the instrument of transfer.

D. Expenses for Limited Common Areas. Common expenses relating to the limited common areas shall be charged in accordance with Article 6, Section A of the Declaration.

i. Maintenance and Repair. The Board of Directors shall be responsible for the maintenance, repair and replacement (unless necessitated by the negligence, misuse or neglect of an Owner, or of a person gaining access with said Owner's actual or implied consent, in which case such expenses shall be charged to such Owner) of all Limited Common Area, whether located inside or outside of the Units, the costs of which shall be charged to all Owners as a Common Expense except the cost of repairing and replacing Limited Common Area shall be assessed to the units assigned such Limited Common Area.

E. Books. The Association will maintain books of account for common expenses for the common areas, general operating reserves and replacement reserves, in accordance with generally recognized accounting practices, and will have such books of account available for inspection by each Owner or his authorized representative at reasonable business hours. The Association will not less frequently than annually render or cause to be rendered a statement to each Owner of all receipts and disbursements during the preceding year and the balances of the various accounts.

F. Enforcement. The Association of Unit Owners shall have a lien on every Unit for unpaid assessments of common expenses levied against the Unit, which may be applicable to said Unit, in accordance with the provisions of the New Hampshire Condominium Act. Reference is made to RSA Section 356-B:46, as amended from time to time, and any successor statute, describing the enforcement of the Association's lien rights.

G. Delinquent Assessments. In the event an assessment is not paid within thirty (30) days of the date it is due and payable, the Association, through its Board of Directors, may proceed to enforce and collect the said assessment, with interest at the maximum lawful rate of eighteen percent (18%) per annum, whichever is greater, against the unit Owner owing the same in the manner set forth in RSA 356-B:46. Each delinquent unit Owner shall be responsible for attorney's fees, interest and costs incurred by the Association incident to the collection of such delinquent assessments or enforcement of any lien held by the Association for unpaid assessments.

H. Assessments. The Association shall determine the amounts and frequency of assessments for common expenses. In determining the amount, the Association shall in its discretion set a figure for a reasonable prospective period (up to one year) sufficient to accumulate and pay when due the anticipated common expenses for that period. In determining the frequency of the payments, the Association has full discretion to levy the assessments on a quarterly basis or as otherwise determined by the Association. If at the end of any assessment period it is determined that the assessments were estimated too low, the deficiency may be forthwith assessed by the Association and paid by the Unit Owners as a special assessment or assessments.

I. Expense to Unit Owner. No one shall obstruct, commit any waste in or otherwise cause any damage beyond reasonable wear and tear to the Common Area and anyone causing such damage shall pay the expense incurred by the Association in repairing same.

8. GENERAL PROVISIONS

A. Violations. In the event of a violation other than non-payment violation of the Declaration, these By-Laws, or the applicable portions of the Act, the Association, by direction of its Board of Directors, may notify the unit owner by written notice of such breach, and if such violation shall continue for a period of thirty (30) days from the date of this notice, the Association, through its Board of Directors, shall have the right to treat such violation as an intentional and inexcusable and material breach of the Declaration, the By-Laws, or the pertinent provisions of the Condominium Act, and the Association may then, at its option, have the following election: (a) an action at law to recover for its damage on behalf of the Association or on behalf of the other unit owners; (b) an action in equity to enforce performance on the part of the unit owner; or (c) an action in equity for such equitable relief as may be necessary under the circumstances, including injunctive relief. Failure on the part of the Association to maintain such an action at law or in equity within ninety (90) days from date of a written request, signed by a unit owner, sent to the Board of Directors, shall authorize any unit Owner to bring an action in equity or suit at law on account of the violation. Any violations which are deemed by the Board of Directors to be a hazard to public health may be corrected immediately as an emergency matter. The Association shall be entitled to collect all legal fees incurred as a result of any such action or any action instituted for collection of any unpaid assessments.

B. Waiver. The failure of the Association of Unit Owners to insist in any one or more instances upon strict performance of or compliance with any of the covenants of the Owner hereunder, or to exercise any right or option herein contained or to serve any notice, or to institute any action or summary proceeding, shall not be construed as a waiver or a relinquishment for the future, of such covenant or option or right, but such covenant or option or right shall continue and remain in full force and effect.

C. Notices. All notices to Unit Owners shall be deemed given if hand delivered or sent by Registered or Certified Mail, Return Receipt Requested, to the Owner, addressed to the Owner's address appearing on the records of the Association. Any notice given or mailed to one

co-Owner shall be presumed to have been properly given to any other co-Owner, regardless of whether a separate notice was given or sent to said other co-Owner. When any policy of insurance has been obtained on behalf of the Association, written notice of the obtainment thereof and of any subsequent changes therein or termination thereof shall be promptly furnished to each Unit Owner by the Secretary of the Association. Pursuant to the provisions of RSA 356-B:43 (II) all notices shall be sent in accordance with the provisions of the last sentence of RSA 356-B:37-a.

D. Amendment. Except as otherwise provided in the Condominium Act and this Declaration and Bylaws, this Declaration and Bylaws may only be amended by agreement of at least two thirds (2/3) of the Owners, provided, however, that (i) any such amendment shall be executed by such two thirds (2/3) of the Owners or by the President and Treasurer of the Association accompanied by a certification of vote of the Secretary; (ii) evidence of such amendment shall be duly recorded at the Registry pursuant to Section 34 IV, of the Condominium Act; (iii) no amendment to the Declaration shall be adopted that could interfere with the construction, sale, lease or other disposition or use of such Units; (iv) no such amendment shall be contrary to the provisions of the Condominium Act. Any approval of amendments by Mortgagees shall be subject to the provisions of and limitations of RSA 356-B.

E. Resale by Purchaser. In the event of any resale of a unit or any interest therein by any person (other than the Declarant or its successors in interest) the prospective Unit Owner shall have the right to obtain from the Association, prior to the contract date of the disposition, the following:

i. A statement of any capital expenditures and major maintenance expenditures anticipated by the Association within the current or succeeding two fiscal years;

ii. A statement of the status and amount of any reserve for the major maintenance or replacement fund, and any portion of such fund earmarked for any specified project by the Association;

iii. A copy of the income statement and balance sheet of the Association for the last fiscal year for which such statement is available;

iv. A statement of the status of any pending suits or judgments in which the Association is a defendant;

v. A statement setting forth what insurance coverage is provided for all Unit Owners by the Association and what additional insurance coverage would normally be secured by each individual Unit Owner;

vi. A statement that any improvements or alterations made to the Unit or the limited common area assigned thereto by the prior Unit Owner are not known to be in violation of the Declaration.

The President of the Association or any other Officer of the Association shall furnish such statements upon written request of any prospective Unit Owner within ten (10) days of the receipt of such request.

Said statement once issued shall be binding upon the Association, and every other Unit Owner. The Association may establish a fee to be charged to the Unit Owner in consideration of issuing said statement, which fee shall not exceed \$10.00 for each request, unless a higher amount is permitted by law.

F. Notices to or from Mortgagees

i. Notice to Board. A Unit Owner who mortgages his condominium unit shall notify the Board of the name and address of his mortgagee and the principal amount of such mortgage. The Board shall maintain suitable records pertaining to such mortgages.

ii. Reporting. The Board, whenever so requested in writing by a mortgagee of a condominium unit, shall promptly report any then unpaid assessments for common expenses due from, or any other default by, the Owner of the mortgaged condominium unit. The Board shall be entitled to require a fee of Ten Dollars (\$10.00) for each report provided a mortgagee.

iii. Default. The Board shall give written notice to an Owner of any default by the Owner in the performance of any obligations under the Condominium Instruments and, if such default is not cured within thirty (30) days, shall send a copy of such notice to each holder of a mortgage covering such unit whose name and address has theretofore been furnished to the Board. No suit or other proceeding may be brought to foreclose the lien for any assessment levied pursuant to the Declaration or these By-Laws except after ten (10) days written notice to the holder of the first mortgage on the unit which is the subject matter of such suit or proceeding.

Dated this ____ day of _____, 2020.

**GREEN & CO BUILDING AND
DEVELOPMENT CO, INC.**

Witness

By: _____
Richard W. Green, President
Duly Authorized

STATE OF NEW HAMPSHIRE
COUNTY OF ROCKINGHAM, ss.

This instrument was acknowledged before me on _____, 2020, by
Richard W. Green, Manager of Midlands Investments, LLC, a New Hampshire limited liability
company.

Notary Public
Printed Name: _____
My Commission Expires: _____

ARCHITECTURAL PLANS

Condominium Development
Banfield Road
Tax Map 256, Lot 2
December 5, 2019

This Page is intentionally Blank

Balmalcolm

540.126.v12 ER

© 2013-2018 Artform Architecture, all rights reserved . You may not build this design without purchasing a license, even if you make changes. This design may have geographic restrictions.



Dear Builders and Home Buyers,

In addition to our Terms and Conditions (the "Terms", available on ArtformHomePlans.com), please be aware of the following:

As defined in the Terms, this is a Design Drawing and may not yet have Construction Drawings (CDs) or the CDs may not reflect design changes. During the conversion of a Design Drawing to Construction Drawings, changes may be necessary including, but not limited to, dimensional changes or changes to the framing and structural supports.

We require that our designs be built substantially as shown in the Drawings. Markups agreed to by Builder and Home Buyer must still be approved by Artform, and may require additional changes, such as structural updates. While we attempt to accommodate requested changes where possible and reasonable, including considerations of design integrity, any and all changes to Drawings must be approved in writing by Artform. It is recommended that you have your Design Drawings updated by Artform prior to attaching any Drawing to any builder agreement. Artform shall not be responsible for the misuse of or unauthorized alterations to any of its Drawings.

- To maintain design integrity, we pay particular attention to features on the front facade, including but not limited to door surrounds, window casings, finished porch column sizes, and roof friezes. While we may allow builders to add their own flare to aesthetic elements, we don't allow our designs to be stripped of critical details. Any such alterations require the express written consent of Artform.
- Increasing or decreasing ceiling heights requires adjustments to window sizes and other exterior elements.

We are not responsible for typographical errors. Home Buyer shall give thoughtful consideration to all drawings and documents provided to them and shall be solely responsible for ensuring that they understand features in the home that are important to them.

Balmalcolm

540.126.v12 ER

© 2013-2018 Artform Architecture, all rights reserved . You may not build this design without purchasing a license, even if you make changes. This design may have geographic restrictions.



Baimalcolm

540.126.v12 ER

© 2013-2018 Artform Architecture, all rights reserved . You may not build this design without purchasing a license, even if you make changes. This design may have geographic restrictions.

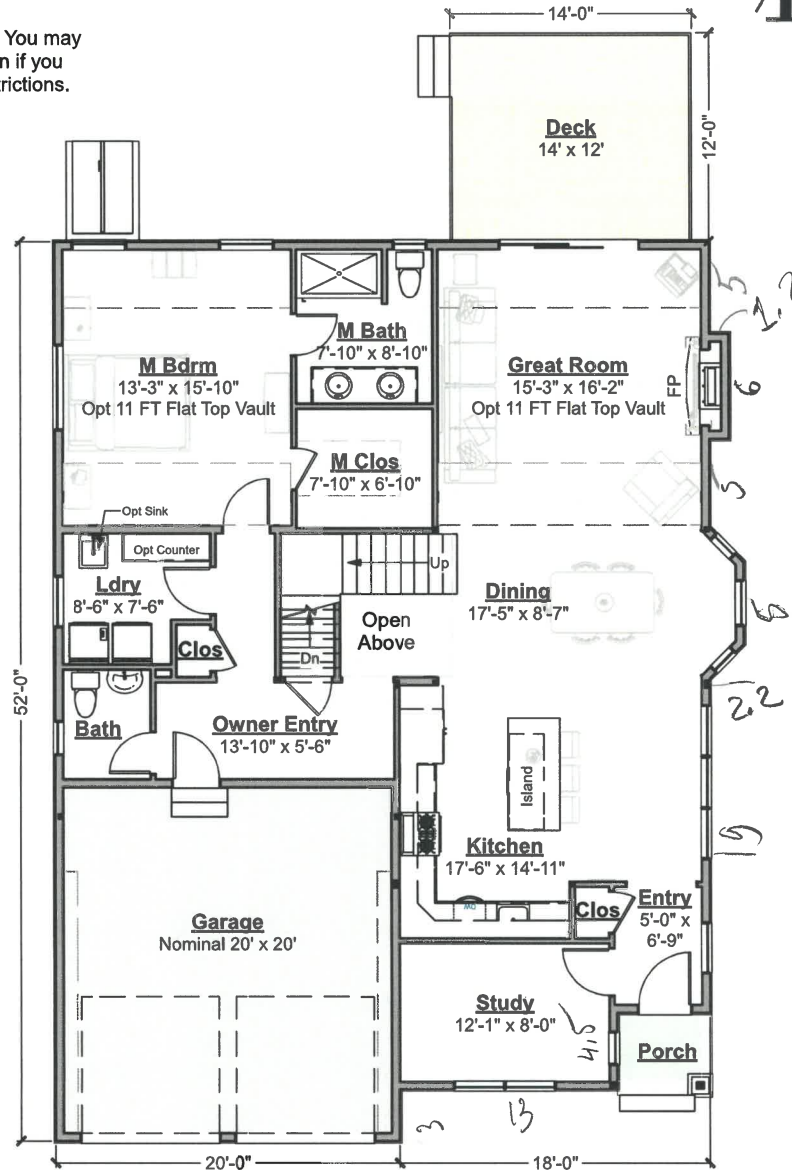

Living Area this Floor: 1515 sq ft
First Floor - 9 FT Ceiling unless noted otherwise

First Floor Plan
Scale: 3/32"=1'

Balmaicoin

540.126.v12 ER

© 2013-2018 Artform Architecture, all rights reserved . You may not build this design without purchasing a license, even if you make changes. This design may have geographic restrictions.

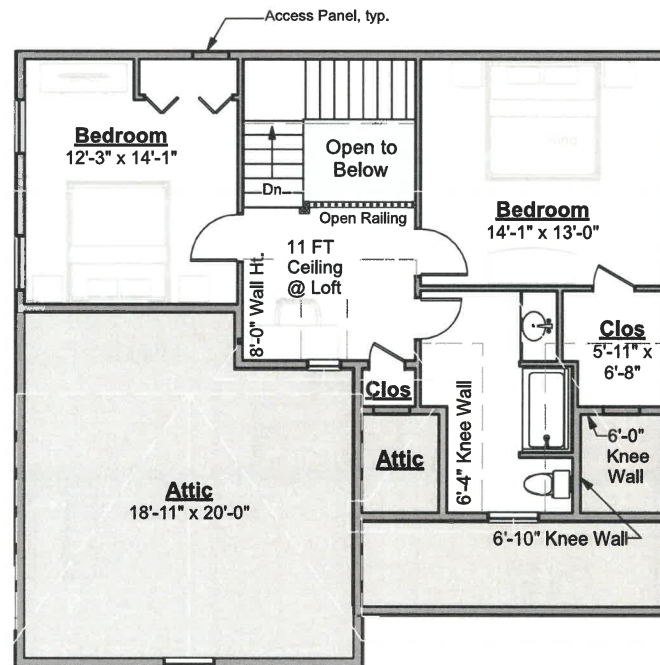

Living Area this Floor: 755 sq ft
First Floor - 9 FT Ceiling unless noted otherwise

Second Floor Plan
Scale: 3/32"=1'

Balmaicollm

540.126.v12 ER

© 2013-2018 Artform Architecture, all rights reserved . You may not build this design without purchasing a license, even if you make changes. This design may have geographic restrictions.

IMPORTANT BASEMENT NOTES:

- Unless an area is specifically designed as "no posts", additional posts may be required.
- Unless specifically noted otherwise, basement beams will be framed below the floor joists.
- Basement spaces accommodate utilities, mechanical equipment and the horizontal movement of plumbing pipes, electrical wires and heating ducts. Both as part of any Construction Drawings produced based on this design and as future decisions made by the builder, changes to accommodate these items must be expected.
- Basement window locations are dependent on site conditions and utility locations. Clarify number and location with your builder.

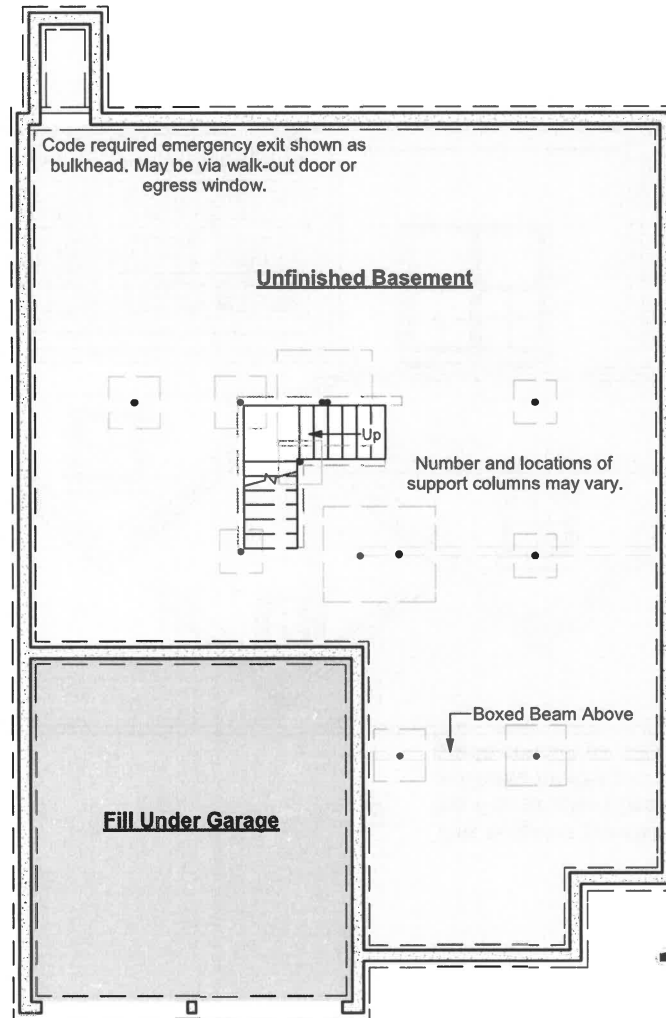

Foundation Plan
Scale: 3/32"=1'

Balmaicollm

540.126.v12 ER

© 2013-2018 Artform Architecture, all rights reserved . You may not build this design without purchasing a license, even if you make changes. This design may have geographic restrictions.

B This height is consistent with the Construction Drawings available for this plan. Your grade conditions may vary.

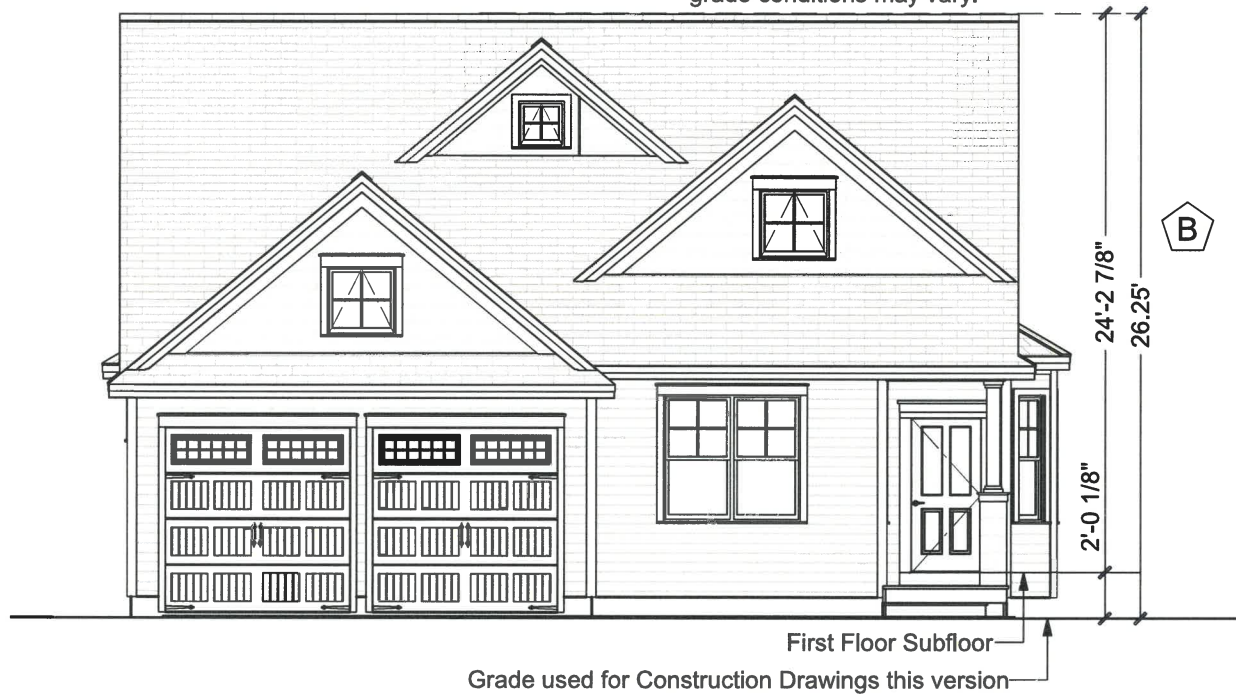

Front Elevation
Scale: 3/32"=1'

Balmalcolm

540.126.v12 ER

© 2013-2018 Artform Architecture, all rights reserved . You may not build this design without purchasing a license, even if you make changes. This design may have geographic restrictions.



Right Elevation
Scale: 3/32"=1'

Balmaicoin

540.126.v12 ER

© 2013-2018 Artform Architecture, all rights reserved . You may not build this design without purchasing a license, even if you make changes. This design may have geographic restrictions.



Rear Elevation
Scale: 3/32"=1'

Balmaicollm

540.126.v12 ER

© 2013-2018 Artform Architecture, all rights reserved . You may not build this design without purchasing a license, even if you make changes. This design may have geographic restrictions.



Left Elevation
Scale: 3/32"=1'

Hennessy Premier, 34 x 30

© 2010-2015 Wendy Welton, all rights reserved . You may not build this design without purchasing a license, even if you make changes. This design may have geographic restrictions.

294.129.v2

 **Artform Home Plans**

603-431-9559



Some items shown are optional and/or may vary. Builder's written specifications always govern.

1. Gas fireplace and it's surround or mantel
2. Kitchen - island, cabinet style & trim, countertop material, etc.
3. Door styles and trim
4. Window grilles and trim, window treatments
5. Stair balusters or low walls at stairs
6. Lighting
7. Material selections (flooring, siding, roofing, paint colors, etc.)
8. Other furnishings
9. Landscaping, paving and walkways
10. Gutters, shutters and other exterior trim components
11. Deck size, railing style, stair location, etc.
12. Amount of exposed basement and/or wood framed walls at basement.

These images are not of any specific building site. Sun and view through windows will vary, as will the site around the house on the exterior and the slope of the land.

Hennessy Premier, 34 x 30
294.129.v2

© 2010-2015 Wendy Welton, all rights reserved . You may not build this design without purchasing a license, even if you make changes. This design may have geographic restrictions.



603-431-9559



Hennessy Premier, 34 x 30

294.129.v2

© 2010-2015 Wendy Welton, all rights reserved. You may not build this design without purchasing a license, even if you make changes. This design may have geographic restrictions.



603-431-9559

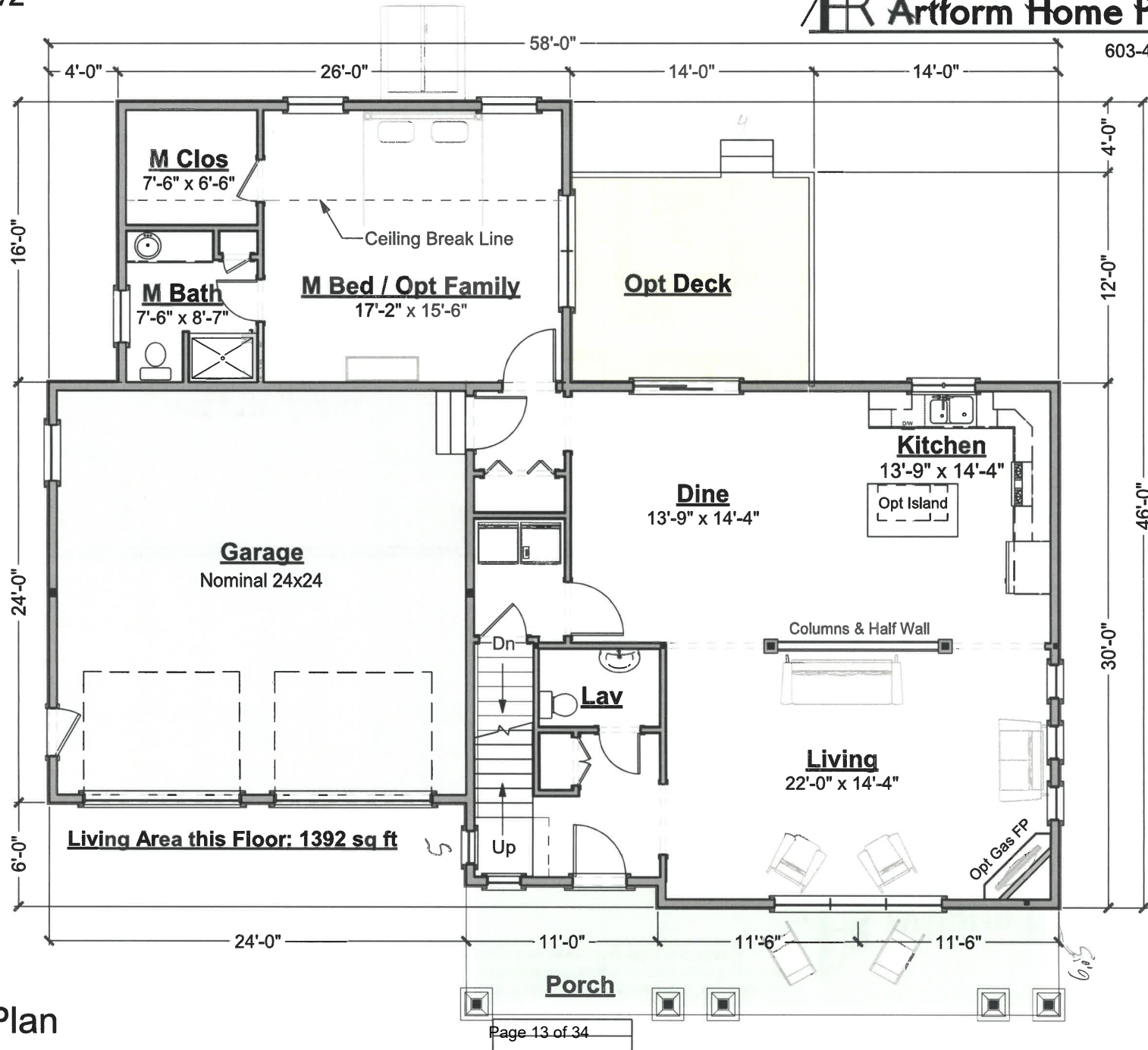

First Floor Plan

Hennessy Premier, 34 x 30

294.129.v2

© 2010-2015 Wendy Welton, all rights reserved . You may not build this design without purchasing a license, even if you make changes. This design may have geographic restrictions.



603-431-9559

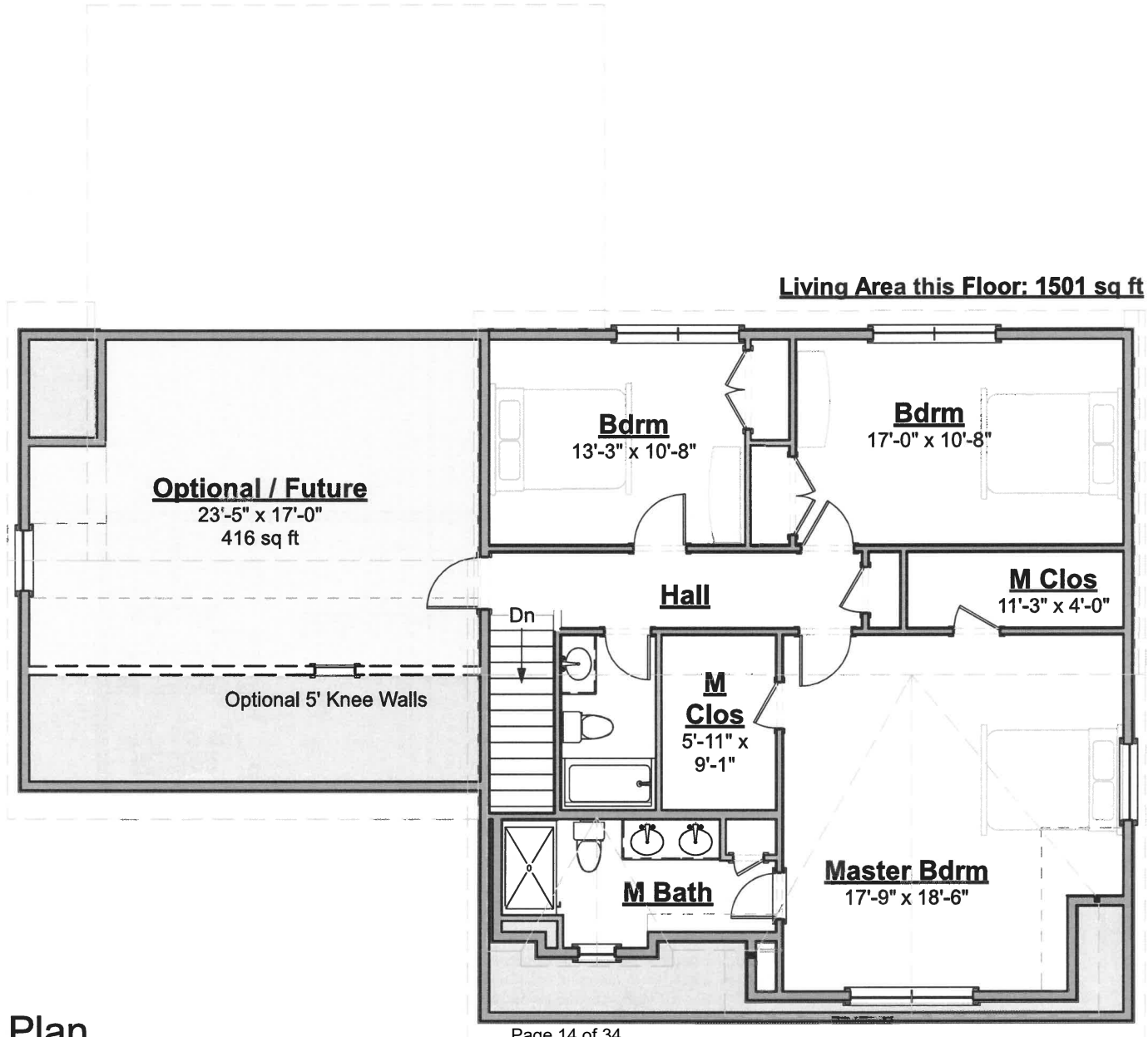

Second Floor Plan

Hennessy Premier, 34 x 30

294.129.v2

© 2010-2015 Wendy Welton, all rights reserved. You may not build this design without purchasing a license, even if you make changes. This design may have geographic restrictions.



603-431-9559

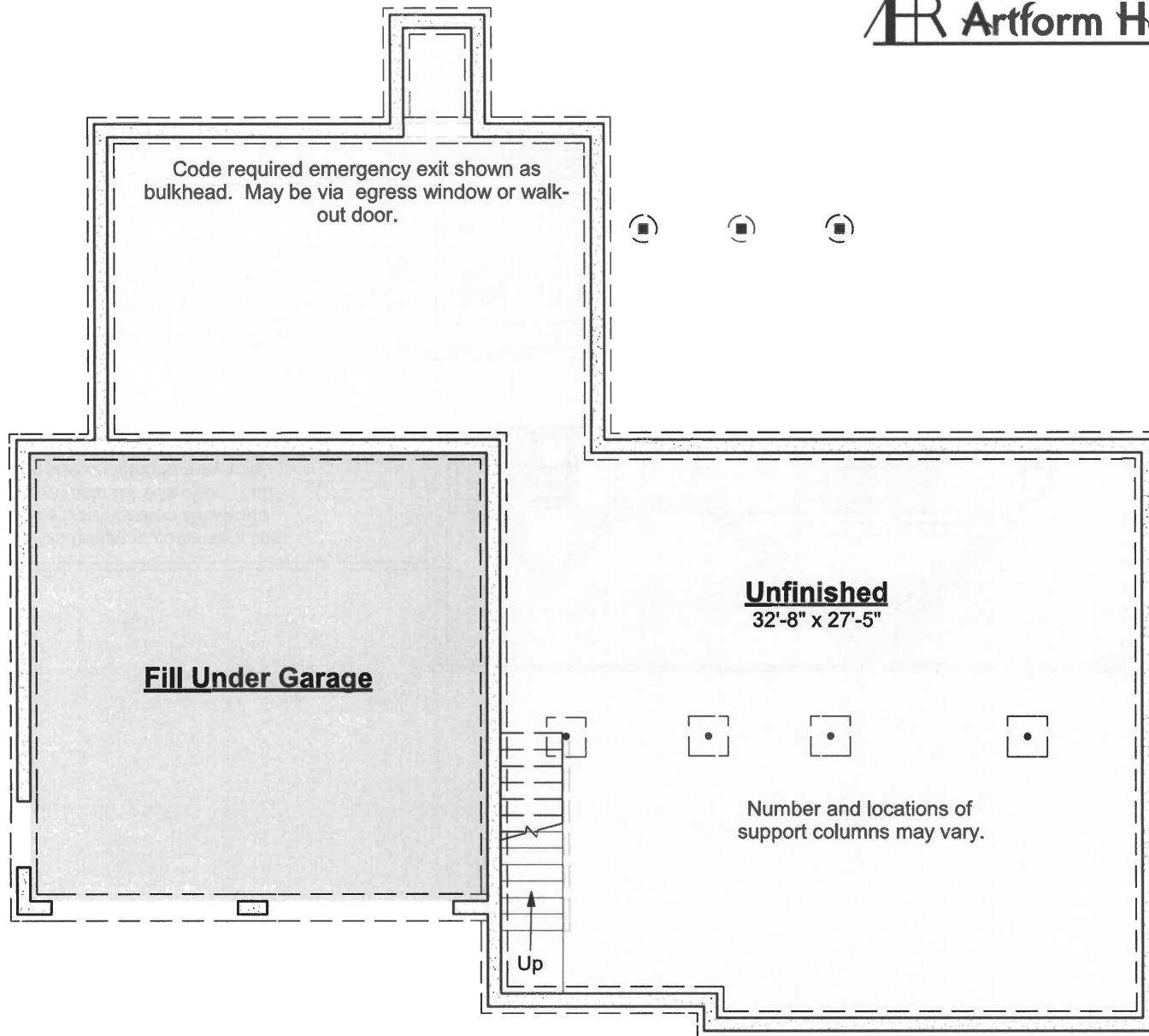

Hennessy Premier, 34 x 30

294.129.v2

© 2010-2015 Wendy Welton, all rights reserved . You may not build this design without purchasing a license, even if you make changes. This design may have geographic restrictions.



603-431-9559



Front Elevation

Hennessy Premier, 34 x 30

294.129.v2

© 2010-2015 Wendy Welton, all rights reserved . You may not build this design without purchasing a license, even if you make changes. This design may have geographic restrictions.



603-431-9559



Right Elevation

Hennessy Premier, 34 x 30

294.129.v2

© 2010-2015 Wendy Welton, all rights reserved . You may not build this design without purchasing a license, even if you make changes. This design may have geographic restrictions.



603-431-9559



Rear Elevation

Hennessy Premier, 34 x 30
294.129.v2

© 2010-2015 Wendy Welton, all rights reserved . You may not build this design without purchasing a license, even if you make changes. This design may have geographic restrictions.



603-431-9559



Left Elevation

May Tulip

318.127.v2 KL

© 2008-2015 Wendy Welton, all rights reserved . You may not build this design without purchasing a license, even if you make changes. This design may have geographic restrictions.



Some items shown are optional and/or may vary. Builder's written specifications always govern.

1. Gas fireplace and it's surround or mantel
2. Kitchen - island, cabinet style & trim, countertop material, etc.
3. Door styles and trim
4. Window grilles and trim, window treatments
5. Stair balusters or low walls at stairs
6. Lighting
7. Material selections (flooring, siding, roofing, paint colors, etc.)
8. Other furnishings
9. Landscaping, paving and walkways
10. Gutters, shutters and other exterior trim components
11. Deck size, railing style, stair location, etc.
12. Amount of exposed basement and/or wood framed walls at basement.

These images are not of any specific building site. Sun and view through windows will vary, as will the site around the house on the exterior and the slope of the land.

May Tullip

318.127.v2 KL

© 2008-2015 Wendy Welton, all rights reserved . You may not build this design without purchasing a license, even if you make changes. This design may have geographic restrictions.



May Tullip

318.127.v2 KL

© 2008-2015 Wendy Welton, all rights reserved . You may not build this design without purchasing a license, even if you make changes. This design may have geographic restrictions.

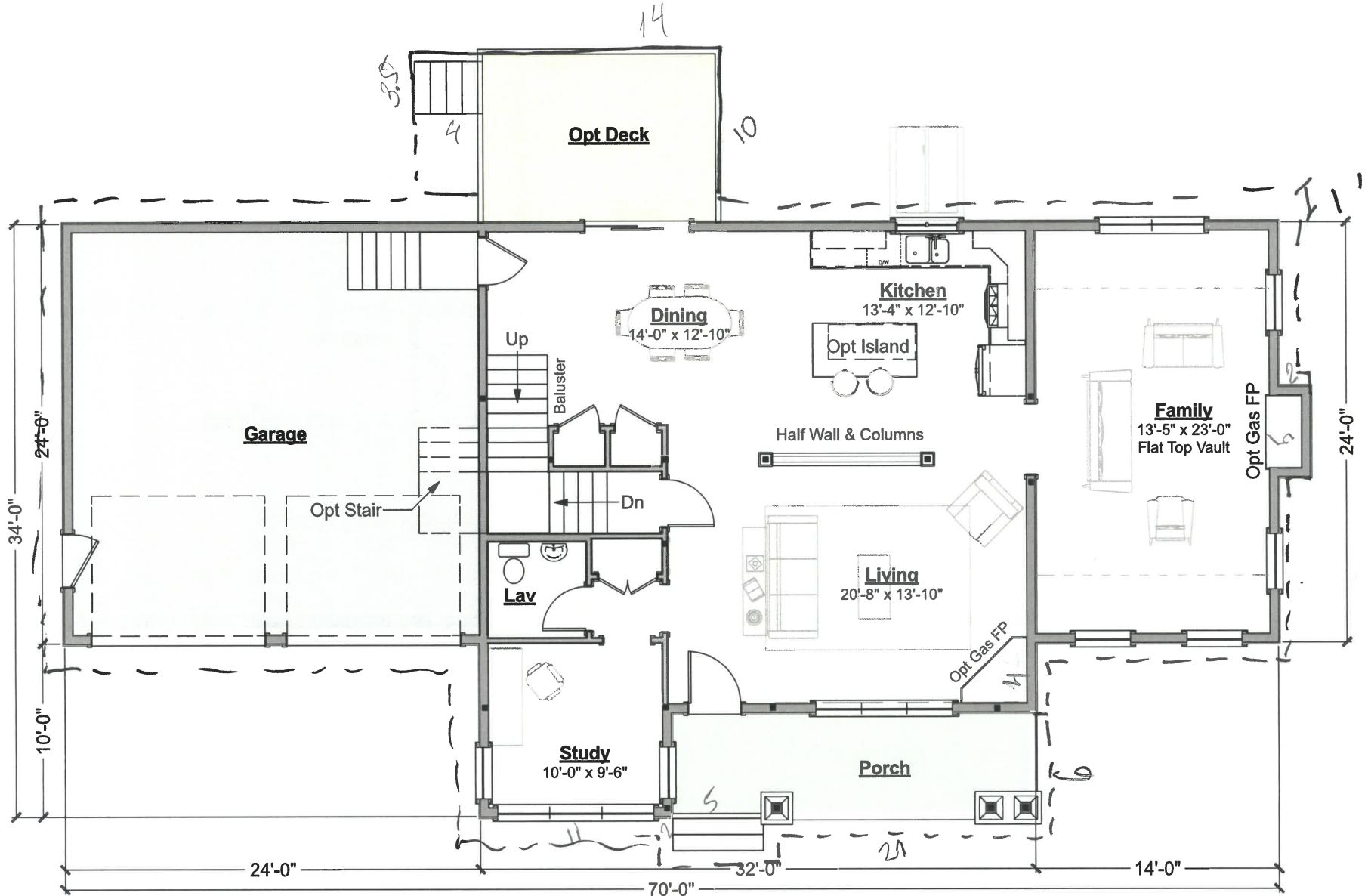

First Floor Plan

May Tullip

318.127.v2 KL

© 2008-2015 Wendy Welton, all rights reserved . You may not build this design without purchasing a license, even if you make changes. This design may have geographic restrictions.

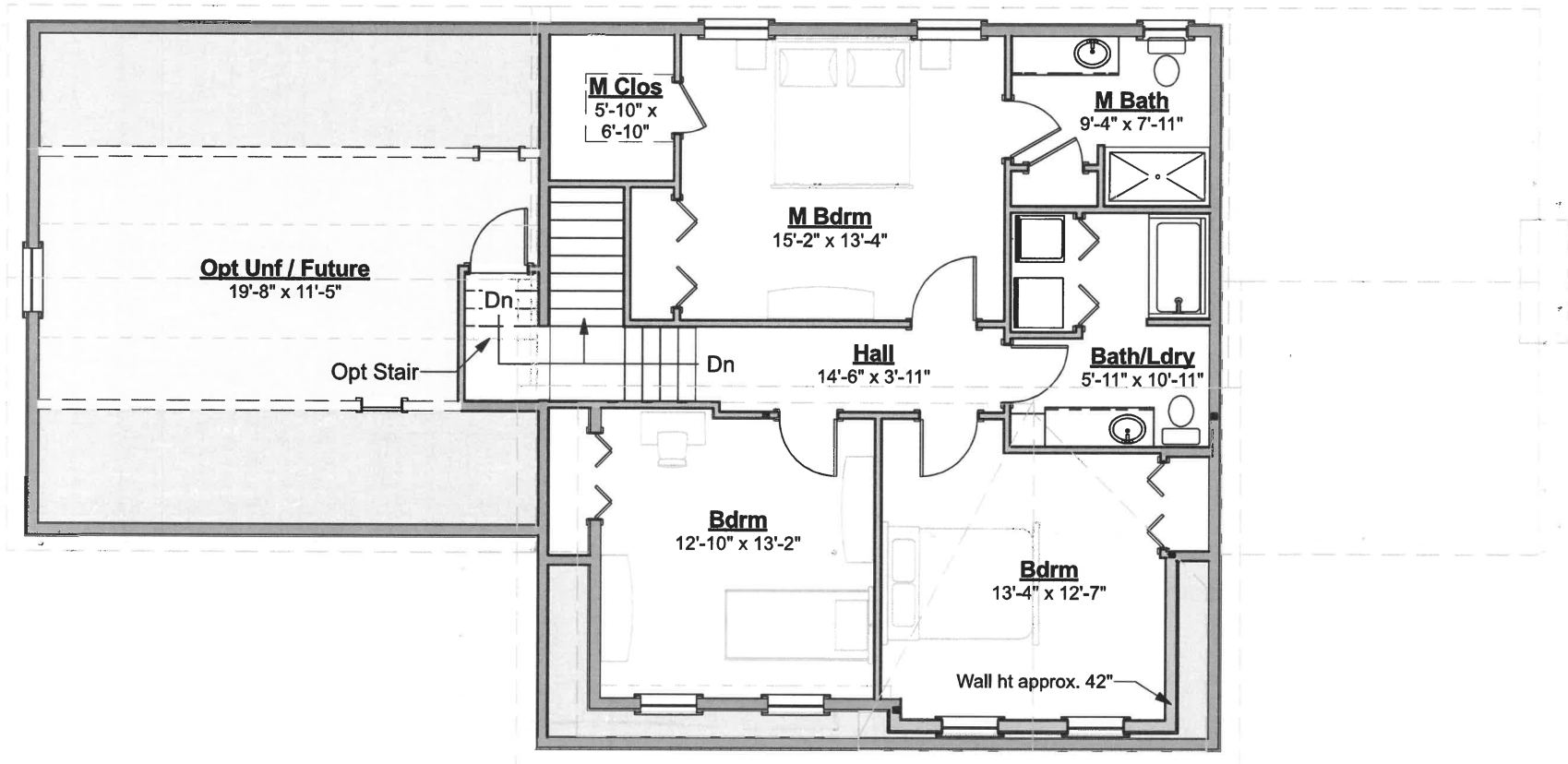

Second Floor Plan

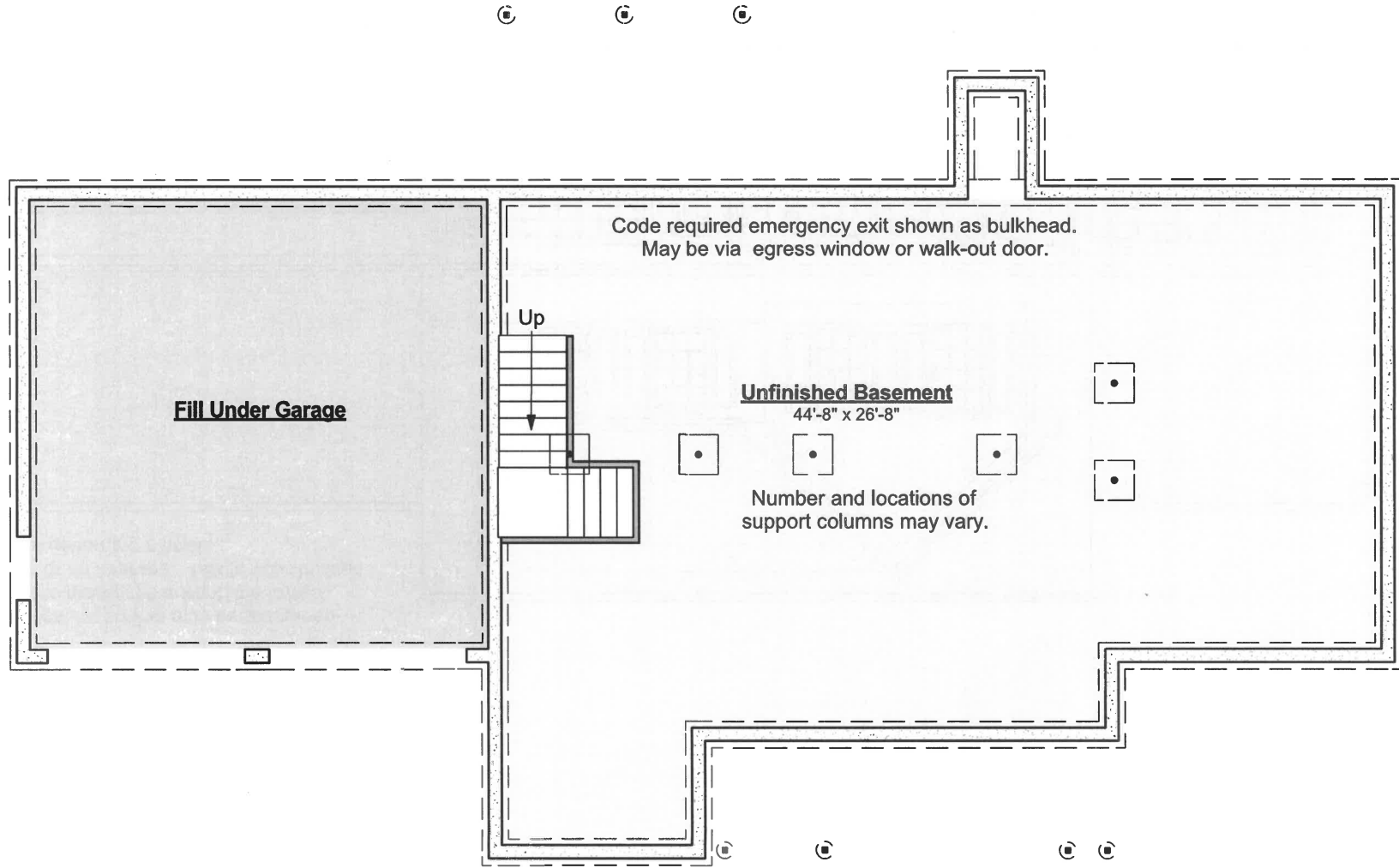

May Tullip

318.127.v2 KL

© 2008-2015 Wendy Welton, all rights reserved . You may not build this design without purchasing a license, even if you make changes. This design may have geographic restrictions.



AFHP Default Grade *1 is 1'-9" below first floor subfloor for consistency in how we list height on the web site. The distance to grade is often more. Talk to your builder.

*3 Height for zoning may be measured from the grade at the front, the lowest grade or an average. Talk to your builder and/or governing officials.



May Tullip

318.127.v2 KL

© 2008-2015 Wendy Welton, all rights reserved . You may not build this design without purchasing a license, even if you make changes. This design may have geographic restrictions.



Right Elevation

May Tullip

318.127.v2 KL

© 2008-2015 Wendy Welton, all rights reserved . You may not build this design without purchasing a license, even if you make changes. This design may have geographic restrictions.



Rear Elevation

May Tullip

318.127.v2 KL

© 2008-2015 Wendy Welton, all rights reserved . You may not build this design without purchasing a license, even if you make changes. This design may have geographic restrictions.



Left Elevation



FRONT ELEVATION

THE WESTFORD

TO BE CONSTRUCTED AT
PAGE FARM OF
ATKINSON, NH
A PLANNED DEVELOPMENT BY GREEN & COMPANY REAL ESTATE

<u>SQUARE FOOTAGE TABLE</u>	
TOTALS EXCLUDE UNFINISHED/STORAGE, GARAGE & OPEN AREAS	
<u>PLAN</u>	<u>SQ. FTG.</u>
FIRST FLOOR	1,047
SECOND FLOOR	1,126
BONUS ROOM	309
TOTAL: W/ BONUS	2,482
TOTAL: W/O BONUS	2,173

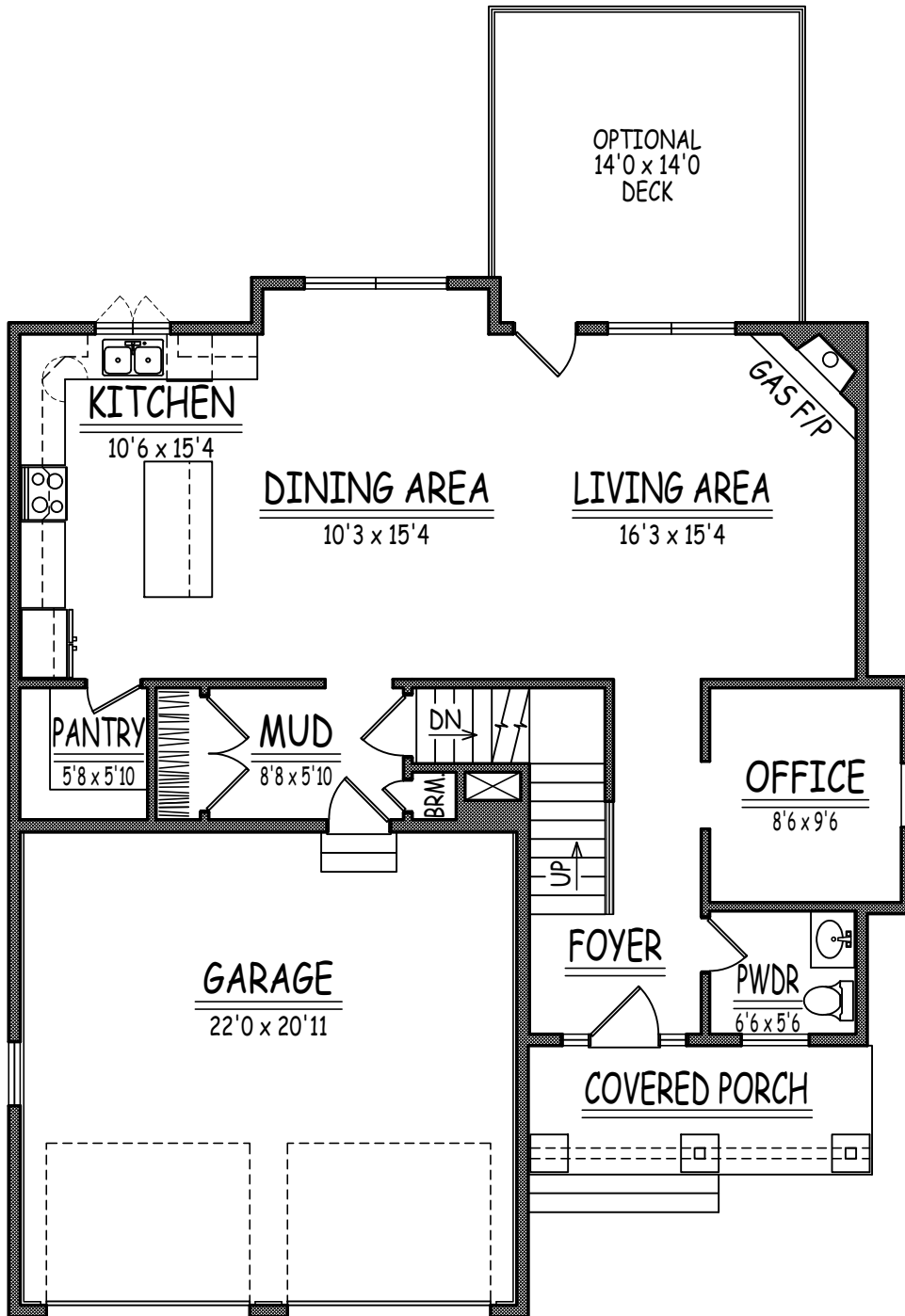

FIRST FLOOR PLAN

1,047 SQUARE FEET
THE WESTFORD

TO BE CONSTRUCTED AT
PAGE FARM OF
ATKINSON, NH

A PLANNED DEVELOPMENT BY GREEN & COMPANY REAL ESTATE

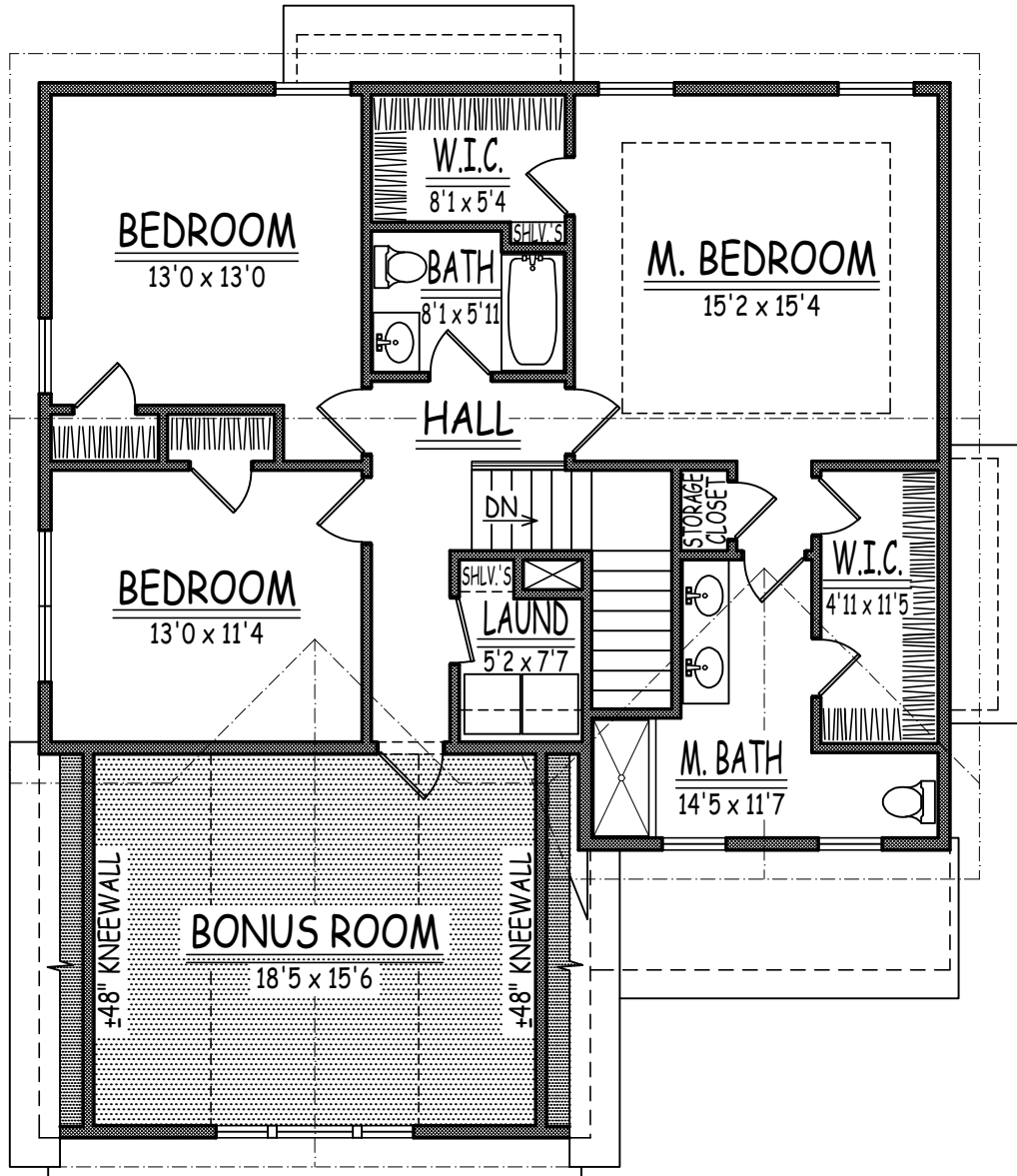

SECOND FLOOR PLAN

1,126 SQUARE FEET
THE WESTFORD

TO BE CONSTRUCTED AT
PAGE FARM OF
ATKINSON, NH

A PLANNED DEVELOPMENT BY GREEN & COMPANY REAL ESTATE

905.120 High Skipper Mate



©2017 Art Form Architecture
High Skipper Mate
Artform Home Plans

	Main	Future	Apt	Main + Future	Main + Apt	All
Living Area	2295 SF	0 SF	0 SF	2295 SF	2295 SF	2295 SF
Bedrooms	3	1	0	4	3	4
Baths	2.5	0.0	0.0	2.5	2.5	2.5

Note - this design has not yet been built. It's here to offer a starting point for customization. It's priced so that changes that do not increase the size significantly will be at no additional charge. Hourly design fees will apply if you make changes.

Use of this document is governed by our **Terms and Conditions**, found on our website:
<http://www.artformhomeplans.com/TermsConditions.a5w>

© 2017 Art Form Architecture, Inc. ALL RIGHTS RESERVED.
You may not build this Design without purchasing a License to Build (as defined in our Terms). Unauthorized

Dear Builders and Home Buyers,

In addition to our Terms and Conditions (the "Terms"), please be aware of the following:

This design may not yet have Construction Drawings (as defined in the Terms), and is, therefore, only available as a Design Drawing (as defined in the Terms and together with Construction Drawings, "Drawings"). It is possible that during the conversion of a Design Drawing to a final Construction Drawing, changes may be necessary including, but not limited to, dimensional changes. Please see Plan Data Explained on www.ArtformHomePlans.com to understand room sizes, dimensions and other data provided. We are not responsible for typographical errors.

Artform Home Plans ("Artform") requires that our Drawings be built substantially as designed. Artform will not be obligated by or liable for use of this design with markups as part of any builder agreement. While we attempt to accommodate where possible and reasonable, and where the changes do not denigrate our design, any and all changes to Drawings must be approved in writing by Artform. It is recommended that you have your Drawing updated by Artform prior to attaching any Drawing to any builder agreement. Artform shall not be responsible for the misuse of or unauthorized alterations to any of its Drawings.

Facade Changes:

- To maintain design integrity, we pay particular attention to features on the front facade, including but not limited to door surrounds, window casings, finished porch column sizes, and roof friezes. While we may allow builders to add their own flare to aesthetic elements, we don't allow our designs to be stripped of critical details. Any such alterations require the express written consent of Artform.
- Increasing ceiling heights usually requires adjustments to window sizes and other exterior elements.

Floor plan layout and/or Structural Changes:

- Structural changes always require the express written consent of Artform
- If you wish to move or remove walls or structural elements (such as removal of posts, increases in house size, ceiling height changes, addition of dormers, etc), please do not assume it can be done without other additional changes (even if the builder or lumber yard says you can).

905.120 High Skipper Mate

First Floor

	Area	Beds	Baths
Main	1119 SF	0	0.5
Future	0 SF	1	0
Apt	0 SF	0	0
Total	1119 SF	1	0.5

Ceiling Height

Shown 9'-0"

Possible* 8'-0"

* See Major Change information on plan page for cost

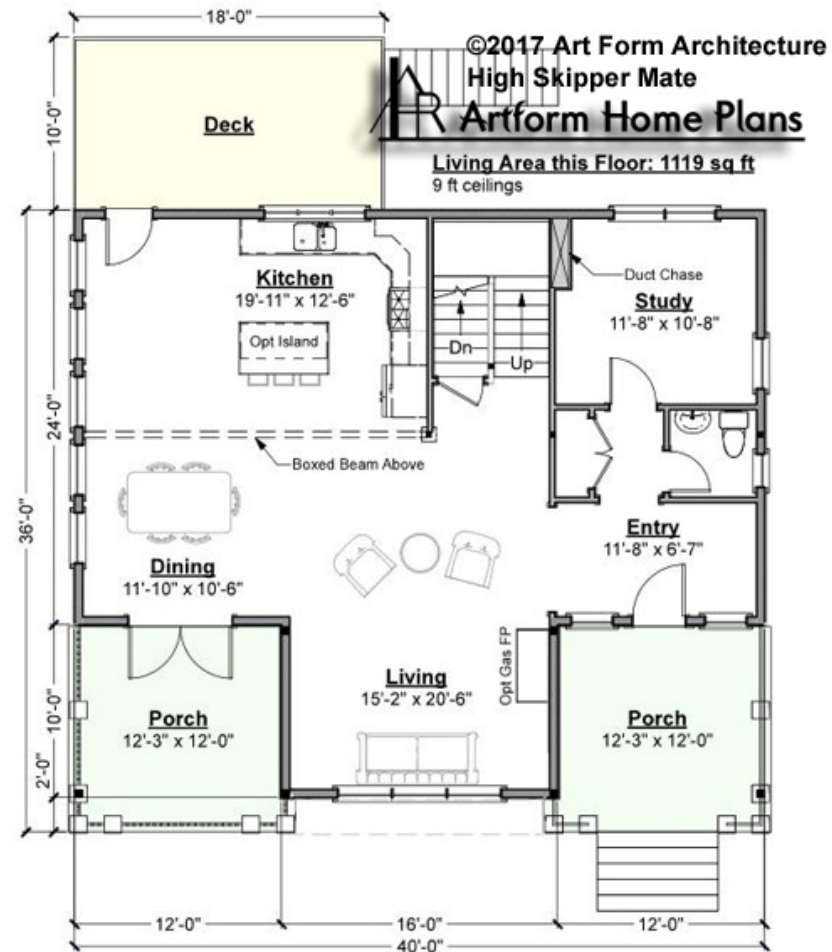

CRS 905.120 High Skipper Mate

Use of this document is governed by our **Terms and Conditions**, found on our website:
<http://www.artformhomeplans.com/TermsConditions.a5w>

© 2017 Art Form Architecture, Inc. ALL RIGHTS RESERVED.
You may not build this Design without purchasing a License to Build (as defined in our Terms). Unauthorized changes are not permitted and violate copyright laws, which provide substantial penalties for infringement.

Some features show are optional. Your Purchase & Sale Agreement governs, whether items are labeled "optional" in this document or not.

We are not responsible for typographical errors.

905.120 High Skipper Mate

Second Floor

	Area	Beds	Baths
Main	1176 SF	3	2
Future	0 SF	0	0
Apt	0 SF	0	0
Total	1176 SF	3	2

Ceiling Height	
Shown	8'-0"
Possible*	8'-0"

* See Major Change information on plan page for cost



CRS 905.120 High Skipper Mate

Use of this document is governed by our **Terms and Conditions**, found on our website:
<http://www.artformhomeplans.com/TermsConditions.a5w>

© 2017 Art Form Architecture, Inc. ALL RIGHTS RESERVED.
You may not build this Design without purchasing a License to Build (as defined in our Terms). Unauthorized changes are not permitted and violate copyright laws, which provide substantial penalties for infringement.

Some features show are optional. Your Purchase & Sale Agreement governs, whether items are labeled "optional" in this document or not.

We are not responsible for typographical errors.

905.120 High Skipper Mate

Basement Floor

	Area	Beds	Baths
Main	0 SF	0	0
Future	0 SF	0	0
Apt	0 SF	0	0
Total	0 SF	0	0

Ceiling Height		
Shown	7'-8"	
Possible*	7'-8"	

* See Major Change information on plan page for cost

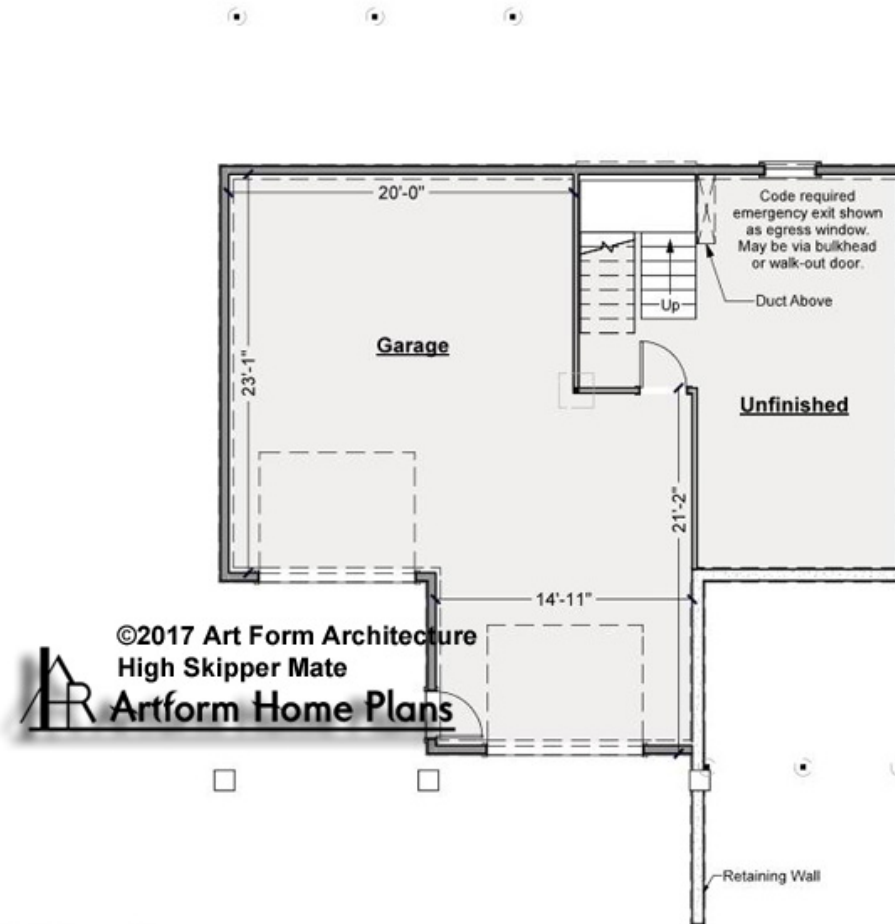

CRS 905.120 High Skipper Mate

Use of this document is governed by our **Terms and Conditions**, found on our website: <http://www.artformhomeplans.com/TermsConditions.a5w>

© 2017 Art Form Architecture, Inc. ALL RIGHTS RESERVED.
 You may not build this Design without purchasing a License to Build (as defined in our Terms). Unauthorized changes are not permitted and violate copyright laws, which provide substantial penalties for infringement.

Some features show are optional. Your Purchase & Sale Agreement governs, whether items are labeled "optional" in this document or not.

We are not responsible for typographical errors.

905.120 High Skipper Mate

Front Elevation



CRS 905.120 High Skipper Mate

Use of this document is governed by our **Terms and Conditions**, found on our website:
<http://www.artformhomeplans.com/TermsConditions.a5w>

© 2017 Art Form Architecture, Inc. ALL RIGHTS RESERVED.
You may not build this Design without purchasing a License to Build (as defined in our Terms). Unauthorized changes are not permitted and violate copyright laws, which provide substantial penalties for infringement.

Some features show are optional. Your Purchase & Sale Agreement governs, whether items are labeled "optional" in this document or not.

We are not responsible for typographical errors.

905.120 High Skipper Mate

Right Elevation

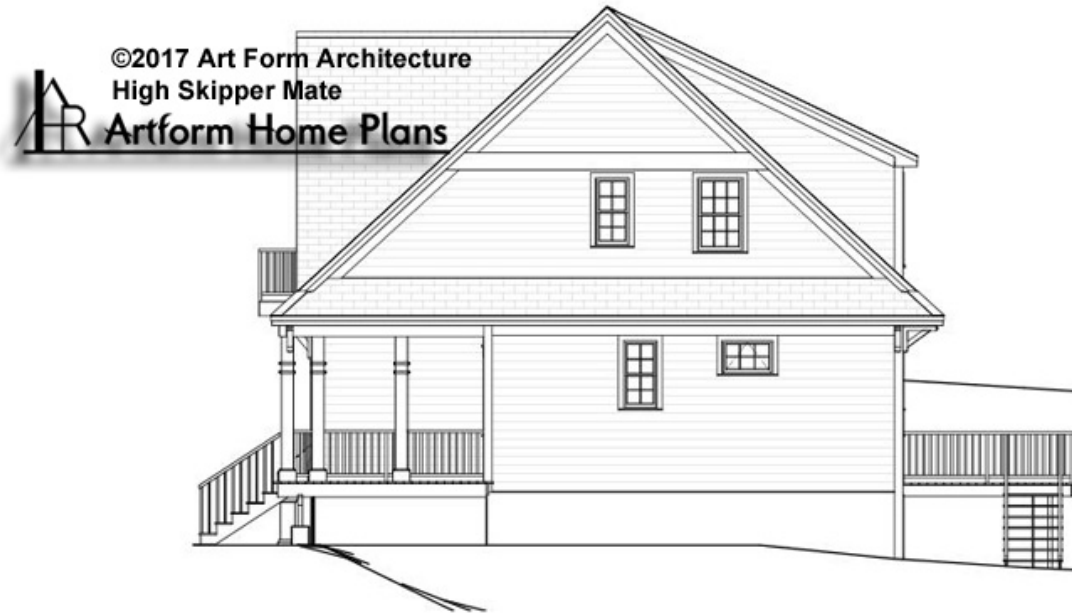

CRS 905.120 High Skipper Mate

Use of this document is governed by our **Terms and Conditions**, found on our website:
<http://www.artformhomeplans.com/TermsConditions.a5w>

© 2017 Art Form Architecture, Inc. ALL RIGHTS RESERVED.
You may not build this Design without purchasing a License to Build (as defined in our Terms). Unauthorized changes are not permitted and violate copyright laws, which provide substantial penalties for infringement.

Some features show are optional. Your Purchase & Sale Agreement governs, whether items are labeled "optional" in this document or not.

We are not responsible for typographical errors.

905.120 High Skipper Mate

Rear Elevation

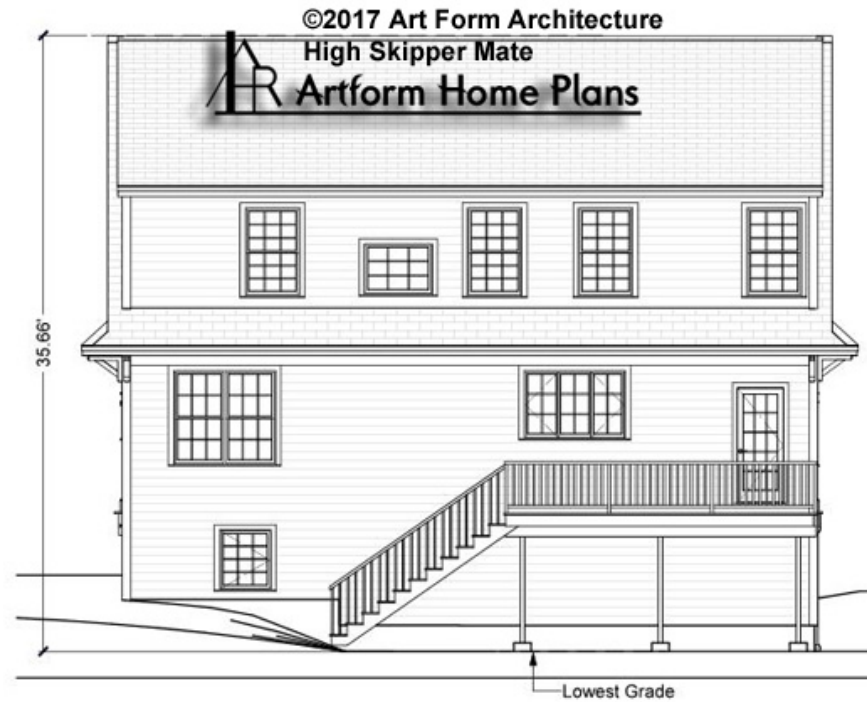

CRS 905.120 High Skipper Mate

Use of this document is governed by our **Terms and Conditions**, found on our website:
<http://www.artformhomeplans.com/TermsConditions.a5w>

© 2017 Art Form Architecture, Inc. ALL RIGHTS RESERVED.
You may not build this Design without purchasing a License to Build (as defined in our Terms). Unauthorized changes are not permitted and violate copyright laws, which provide substantial penalties for infringement.

Some features show are optional. Your Purchase & Sale Agreement governs, whether items are labeled "optional" in this document or not.

We are not responsible for typographical errors.

905.120 High Skipper Mate

Left Elevation



CRS 905.120 High Skipper Mate

Use of this document is governed by our **Terms and Conditions**, found on our website:
<http://www.artformhomeplans.com/TermsConditions.a5w>

© 2017 Art Form Architecture, Inc. ALL RIGHTS RESERVED.
You may not build this Design without purchasing a License to Build (as defined in our Terms). Unauthorized changes are not permitted and violate copyright laws, which provide substantial penalties for infringement.

Some features show are optional. Your Purchase & Sale Agreement governs, whether items are labeled "optional" in this document or not.

We are not responsible for typographical errors.



Civil Engineers
Structural Engineers
Traffic Engineers
Land Surveyors
Landscape Architects
Scientists

June 23, 2020

TFM Project No: 47361.00

Juliet Walker, Planning Director
Portsmouth Planning Department
City Hall, 3rd Floor
1 Junkins Avenue
Portsmouth, NH 03801

Re: Response to Conditions of Approval from the April TAC Review for Condominium Development, Banfield Road, Tax Map 256, Lot 2

Dear Juliet,

On behalf of our client, Green & Company, TF Moran, Inc. (TFM) respectfully submits the following revised plans and letter in response to the Conditions of Approval made by the Technical Advisory Committee (TAC) at our April meeting.

Included in this submittal are the following material:

- Electronic Copies: 11"x17" Plan Set of the "The Village at Banfield Woods", Banfield Road, Portsmouth, NH, Tax Map 256, Lot 2, Dated September 25, 2019, last revised April 29, 2020.
- Electronic Copy: "Drainage Analysis Summary for The Village ay Banfield Woods," By TFMoran, Dated April 29, 2020.

To facilitate your review of the plans, we have provided TAC Conditions of Approval along with our responses, which are shown in *blue*.

Comments from the January TAC Review for Condominium Development:

- 1) Applicant shall overlay landscape plans with utility plans, check for conflicts and revise as necessary;**

The landscape plan was overlaid with the utility plan to check for conflicts, and none exist. A worksheet has been included for your review.

- 2) Applicant shall modify water main per the sketch provided by DPW separately;**

The water main has been modified based on the sketch provided by the Department of Public Works.



- 3) Street name sign to be added to plan that is compliant with MUTCD and DPW standards;**

Street name sign has been added to plans. See sheet C-33.

- 4) Gas is shown on utility plan as deepest utility. Typical depth is 3'. Applicant to update plans as required by DPW;**

The detail was provided to show minimum horizontal separation. The detail was revised to call for the gas line to be an average depth of three feet. See sheet C-34.

- 5) Sheet C-34, Buried Gate Valve Detail shall be updated to show anchor tees with gate valves. Same detail, note 1 does not apply to this detail, note 2 is incorrect. Valve to open right;**

The Gate Valve detail has been modified to use anchor tees and the notes have been updated.

- 6) Water Service Connection Detail says type K copper services, plan says CTS, please specify properly and update. If CTS, tracer wire will be required;**

The Water Service Connection Detail has been modified specifying CTS service pipe. See Sheet C-34. A call for a tracer wire (Indicator tape) has been added to this detail.

- 7) Add note to hydrant, 'hydrant to open right';**

The note for the fire hydrant detail has been revised calling for the hydrant to open to the right. See Sheet C-34.

- 8) Specify NH standard frame and grate for catch basins;**

The catch basin details have been revised to specify standard NH frame and grates. See sheets C-33 and C-34.

- 9) Water main shall be DI, PVC shown on detail is not approved and shall be updated;**

The PVC option has been removed from Water Main Trench Detail, leaving only the DI option. See sheet C-34.

- 10) Gravel select should extend at least 24" past EOP because road is so narrow;**

The Roadway Typical Section has been revised to show the select extending 2' beyond the face of curb. See sheet C-36.

- 11) Details for retaining walls along the roadway need to be designed and stamped by PE and submitted for review;**

A note has been added to the Retaining Wall Typical Section stating that the retaining wall must be designed and stamped by a professional engineer prior to construction and that the plans must be submitted to the City of Portsmouth for their approval. See sheet C-36.

- 12) Applicant shall add a note to the Lighting Plan that roadway lighting shall be dark sky friendly and lighting details shall be updated accordingly;**

Notes have been added to the Lighting Plan and details calling for dark sky friendly lighting. See sheets C-20A, B and C and C-33.

- 13) Stormwater maintenance plan and cleaning report need to be submitted yearly to the DPW and Planning Department. Applicant shall include a note on the plan for this requirement;**

The Stormwater Operation and Maintenance Plan is included in this submittal. This plan includes a provision requiring the Condominium Association submit a report to the City of Portsmouth Planning Department and Department of Public Works by January 1st of every year. See sheet C-01, General Note #17.

- 14) Extent of guardrail to be used shall be shown clearly and plans shall call out where guardrail locations are required. Plans shall specify requirements per AASHTO;**

Guardrail is not necessary for this roadway and therefore not shown on plans pursuant to AASHTO Guidelines for Geometric Design of Low-Volume Roads, Second Edition, 2019.

- 15) Move the stop sign and stop bar to 10 feet from the edge of Banfield Road;**

The stop bar has been moved to 10 feet off the edge of Banfield road and the stop sign aligned with it. See sheet C-05.

- 16) There appears to be a tree in the path of the fire truck turning path at the intersection with the first internal cross street. The landscape plans and the fire truck turning path plans should be overlaid to determine if there are any other locations where conflicts may occur;**

The proposed landscaping is shown on the Fire Truck Movement Plans, see Sheets C-30 & C-31. The landscaping has been revised to avoid any conflicts with the turning paths.

- 17) See separate comments provided by peer reviewer (CMA) for drainage system. Final sign off from peer review is required for the drainage system design;**

A letter from CMA has been included stating their concurrence with our engineering analysis and the proposed construction appears reasonable.

- 18) Sewer design plan shall be submitted and shall include percolation test data as required by TAC. Third party review and approval is required for the design prior to submission to Planning Board;**

An Overview Layout of all Individual Sewage Disposal Systems have been submitted to CMA for their review. This plan is also included in the submittal to the Planning Board.

- 19) Applicant shall provide documentation that an analysis of the habitat crossings proposed are the preferred design versus a bridge crossing as previously discussed with TAC;**

Additional documentation demonstrating that a bridge is not a practical solution, is provided herewith.

20) Applicant shall update plans to fully align the two common access driveways at the front end of the development.

The two common drives have been revised and are now fully aligned. See sheets P-01, C-04 and C-06.

Conditions to be included in Planning Board approval:

21) Utilities and storm drainage to be overseen by third party during construction;

A note requiring a third-party inspector has been added to the Utility Notes (Note 14) and Grading Notes (Note 15). See sheet C-01.

22) Hydrant maintenance plan shall be provided;

Per discussion with DPW, a Private Fire Hydrant Service Application is required in lieu of a Hydrant Maintenance Plan. This will be submitted prior to construction.

23) ECO Passage Grates to be reviewed every 5 years for compliance with H2O loading by NH PE, report to be submitted to DPW. Applicant shall submit Condominium documents that outline this requirement subject to final review and approval by DPW, Planning, and Legal Departments.

The 5-year inspection for the ecopassage grates has been added to the Stormwater Management System Operation & Maintenance Manual.

We trust the above responses satisfy the Conditions of Approval from the April 7, 2020 meeting. We look forward to presenting this project at the May Planning Board meeting.

Respectfully,
TFMoran, Inc.

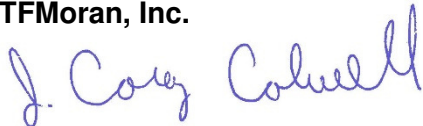

J. Corey Colwell, LLS
Principal

JCC/alb

cc: Rick Green, Michael Green, Jenna Green

Nov 12, 2019 - 1:41pm
F:\MSC Projects\47381 - Portsmouth\47381-00 - Green & Co - Banfield Road\Design\Production Drawings\Details.dwg

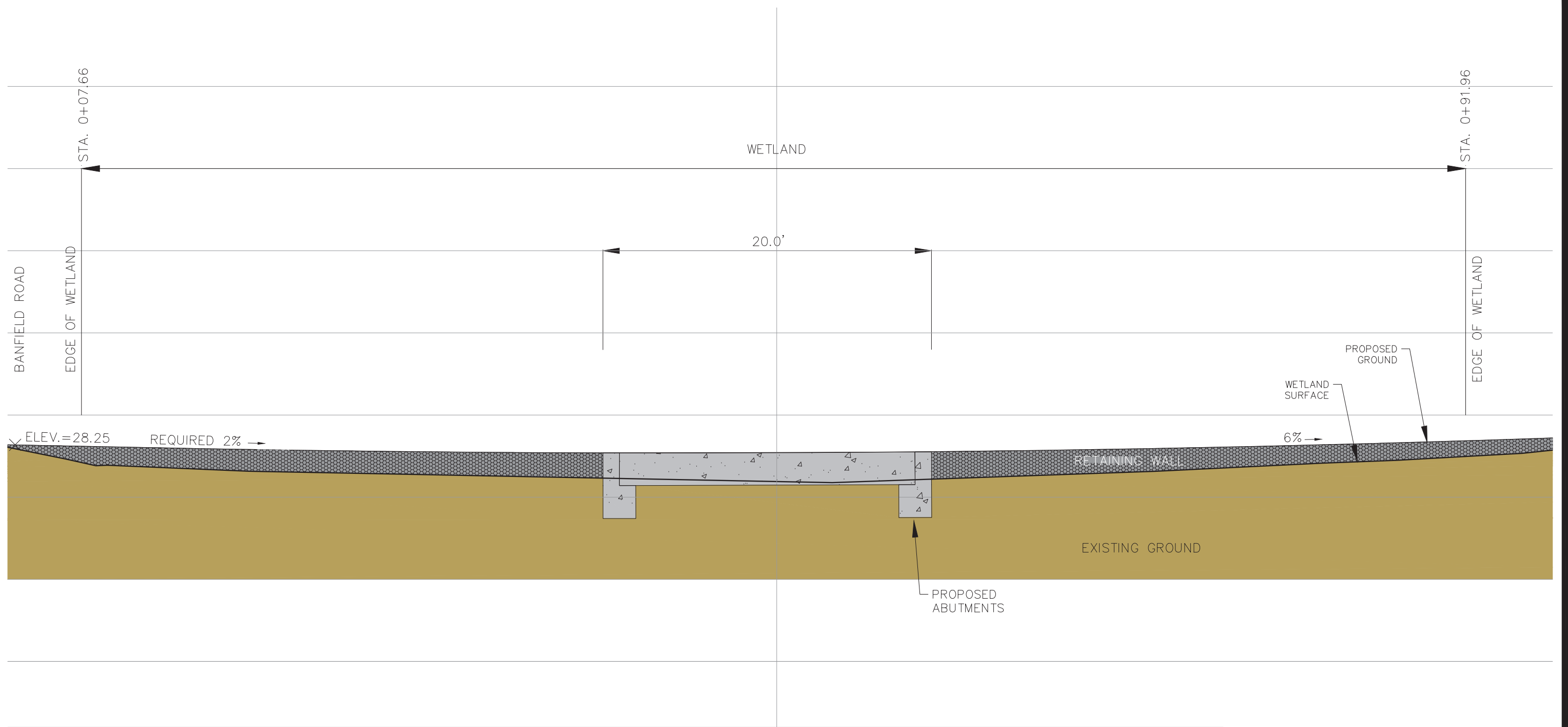

BRIDGE OPTION

SITE DEVELOPMENT PLANS
 TAX MAP 256 LOT 2
DETAILS
BANFIELD ROAD
PORTSMOUTH, NH
 OWNED BY
WALTER D HETT TRUST
 PREPARED FOR
GREEN & COMPANY REAL ESTATE
 SCALE: NTS SEPTEMBER 25, 2019

Copyright 2019 © Thomas F. Moran, Inc.
 48 Constitution Drive, Bedford, N.H. 03110
 All rights reserved. These plans and materials may not be copied, duplicated, replicated or otherwise reproduced in any form whatsoever without the prior written permission of Thomas F. Moran, Inc.
 This plan is not effective unless signed by a duly authorized officer of Thomas F. Moran, Inc.



REV	DATE	DESCRIPTION	DR	CK

TFM	Civil Engineers	48 Constitution Drive Bedford, NH 03110 Phone (603) 472-4488 Fax (603) 472-9747 www.tfmoran.com	
	Structural Engineers Traffic Engineers Land Surveyors Landscape Architects Scientists		
FILE 47361.00	DR RCK FB CK JUM CADFILE	- DETAILS	D-02

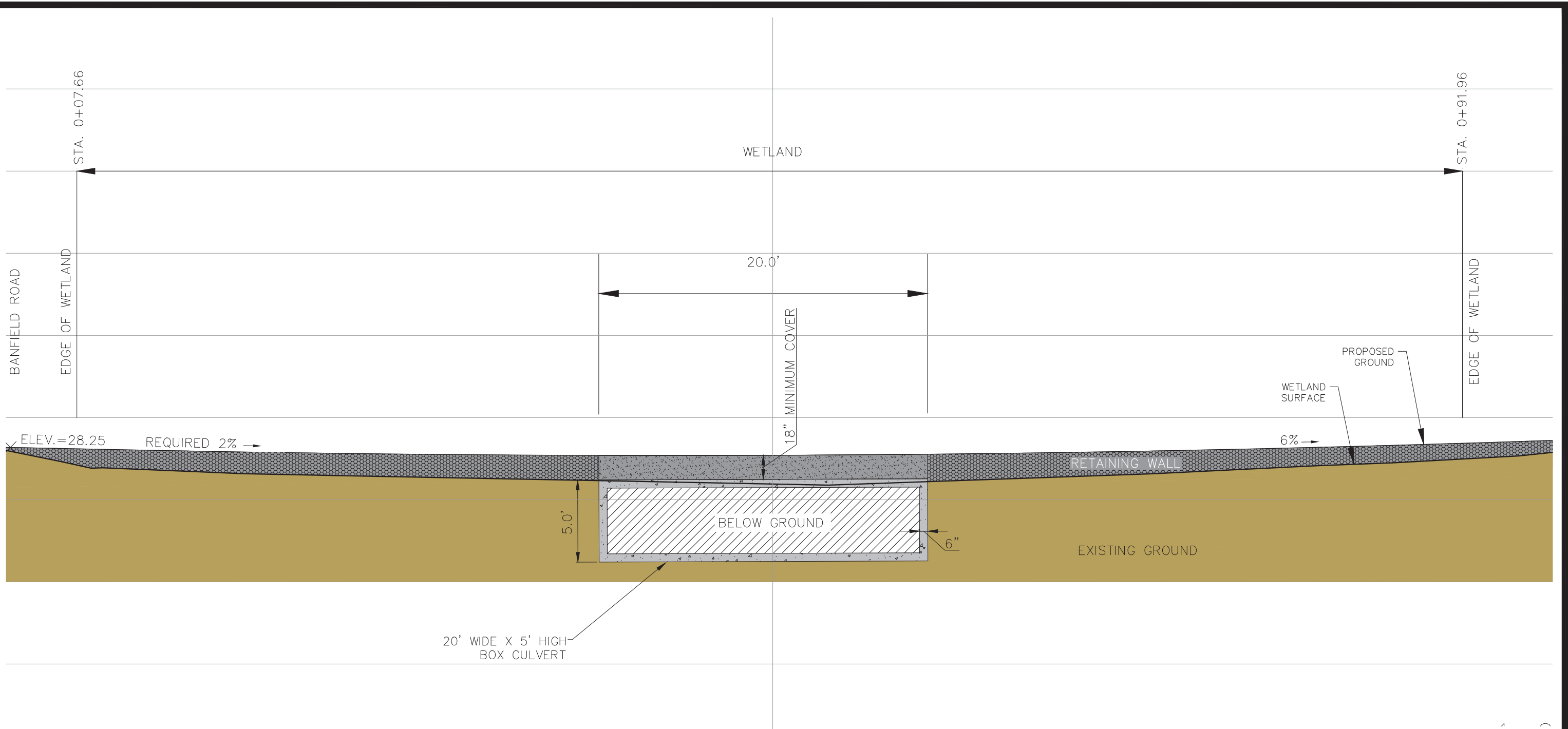

20' WIDE X 5' HIGH
BOX CULVERT

BOX CULVERT
OPTION

SITE DEVELOPMENT PLANS
 TAX MAP 256 LOT 2
DETAILS
BANFIELD ROAD
PORTSMOUTH, NH
 OWNED BY
WALTER D HETT TRUST
 PREPARED FOR
GREEN & COMPANY REAL ESTATE
 SCALE: NTS SEPTEMBER 25, 2019

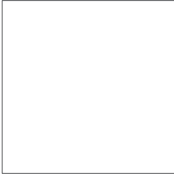

REV	DATE	DESCRIPTION	DR	CK

	Civil Engineers Structural Engineers Traffic Engineers Land Surveyors Landscape Architects Scientists	48 Constitution Drive Bedford, NH 03110 Phone (603) 472-4488 Fax (603) 472-9747 www.tfmoran.com	
	47361.00	DR RCK FB CK JUM CADFILE	- DETAILS

Nov 12, 2019 - 1:37pm

Copyright 2019 © Thomas F. Moran, Inc.
 48 Constitution Drive, Bedford, N.H. 03110
 All rights reserved. These plans and materials may not be copied, duplicated, replicated or otherwise reproduced in any form whatsoever without the prior written permission of Thomas F. Moran, Inc.
 This plan is not effective unless signed by a duly authorized officer of Thomas F. Moran, Inc.



F:\MISC Projects\47361 - Portsmouth\47361-00 - Green & Co - Banfield Road\Design\Production Drawings\Details.dwg



Civil Engineers
Structural Engineers
Traffic Engineers
Land Surveyors
Landscape Architects
Scientists



LANDSCAPE SUMMARY

Project: The Village at Banfield Woods

Date: 01 May 2020

The proposed open space planned unit development of 22 residential units was designed with the goals of creating a quaint residential community that is in harmony with its surroundings. The tree lined road layout gently bends through the site and creates two distinct living communities. The houses were carefully placed with the garages facing the neighbors living areas, limiting inside to inside interaction, while also staying outside of the wetland buffers. The layout of homes maintains the 100' wetland buffer to the adjacent wetlands. The landscaping chosen for these homes, and the entire site, will enhance this buffer and provide vegetation beyond the natural 100' buffer.

Eighty six percent of the plant materials selected for the site are native or improved native species. The remaining fourteen percent have been selected for their hardiness to the area, to add vibrant differing colors, textures and hues of green, as most all native plant materials only have white flowers. The native shade trees have varying shaped silhouettes, branching structures, and will provide four season interest. The fall colors range from multiple shades of yellows, to orange, and vibrant reds. Smaller flowering understory trees will also provide a transitioning flower schedule and attract wildlife to feed in their berries. The shrubs are a mixture of low, medium, large flowering deciduous, and evergreens to provide a layering effect from low to high. The mixture of different sized, evergreen and deciduous plant materials has been utilized as plant massing between homes to create an aesthetically pleasing screening effect, adding additional privacy to the front and rear yards for the residents to enjoy.

A typical Conservation subdivision landscape budget is \$4,000 to \$5,000 per home. Our discussions with the applicant regarding landscaping for this site were about exceeding the typical amount to enhance aesthetic quality. The applicant gave us flexibility to add as many plantings as we felt the site would sustain. With this freedom, we have put extra thought into designing the entire site as-a-whole to create a common sense of place, with bloom times to be offset from one another to add multiple periods of color throughout the year. Each homes' foundation plantings were designed on an individual level to take into account the grading for each site, and how it reflects to the neighboring homes in lieu of providing a typical house landscape, with one tree and many shrubs. Because of this freedom to increase the amount of landscaping above the typical average, each homes' landscape installation cost will range from \$17,000 to \$20,000.

Summary by:

TFMoran, Inc.

Michael Krzeminski, PLA

TFM Project 47361.00

TFMoran, Inc.

48 Constitution Drive, Bedford, NH 03110
T(603) 472-4488 www.tfmoran.com



TFMoran, Inc. Seacoast Division

170 Commerce Way—Suite 102, Portsmouth, NH 03801
T(603) 431-2222



LEGEND	
PROPOSED	
	LARGE DECIDUOUS SHRUBS
	SMALL DECIDUOUS SHRUBS
	LARGE EVERGREEN SHRUBS
	SMALL EVERGREEN SHRUBS
	EVERGREEN TREE
	ORNAMENTAL DECIDUOUS TREE
	MAJOR DECIDUOUS TREE

NOTE:
SELECTED LANDSCAPE PLANT SPECIES TO BE
NATIVE OR APPROVED NATIVE TO NEW ENGLAND.

HORIZONTAL SCALE 1"=30'
30 15 0 30

SITE DEVELOPMENT PLANS
 TAX MAP 256 LOT 2
PRELIMINARY LANDSCAPE PLAN
THE VILLAGE AT BANFIELD WOODS
 PORTSMOUTH, NH
 OWNED BY
WALTER D HETT TRUST
 PREPARED FOR
GREEN & COMPANY REAL ESTATE
 SCALE: 1"=30' SEPTEMBER 25, 2019

TFM Civil Engineers
 Structural Engineers
 Traffic Engineers
 Land Surveyors
 Landscape Architects
 Scientists

48 Constitution Drive
 Bedford, NH 03110
 Phone (603) 472-4488
 Fax (603) 472-9747
 www.tforman.com

47361.00 DR RCK FB
 OK JAM CADFILE LANDSCAPE LANDSCAPE

Copyright 2019 © Thomas F. Moran, Inc.
 48 Constitution Drive, Bedford, N.H. 03110
 All rights reserved. These plans and materials may not be copied,
 duplicated, republished or otherwise reproduced in any form whatsoever
 without the prior written permission of Thomas F. Moran, Inc.
 This plan is not effective unless signed by a duly authorized officer of
 Thomas F. Moran, Inc.

Dec 03, 2019 - 8:47am
 F:\MS-C Projects\47361 - Portsmouth\Banfield Woods - Portsmouth\47361-001 - Green & Co - Banfield Woods\Design\Production Drawings\Landscape.dwg

BANFIELD ROAD

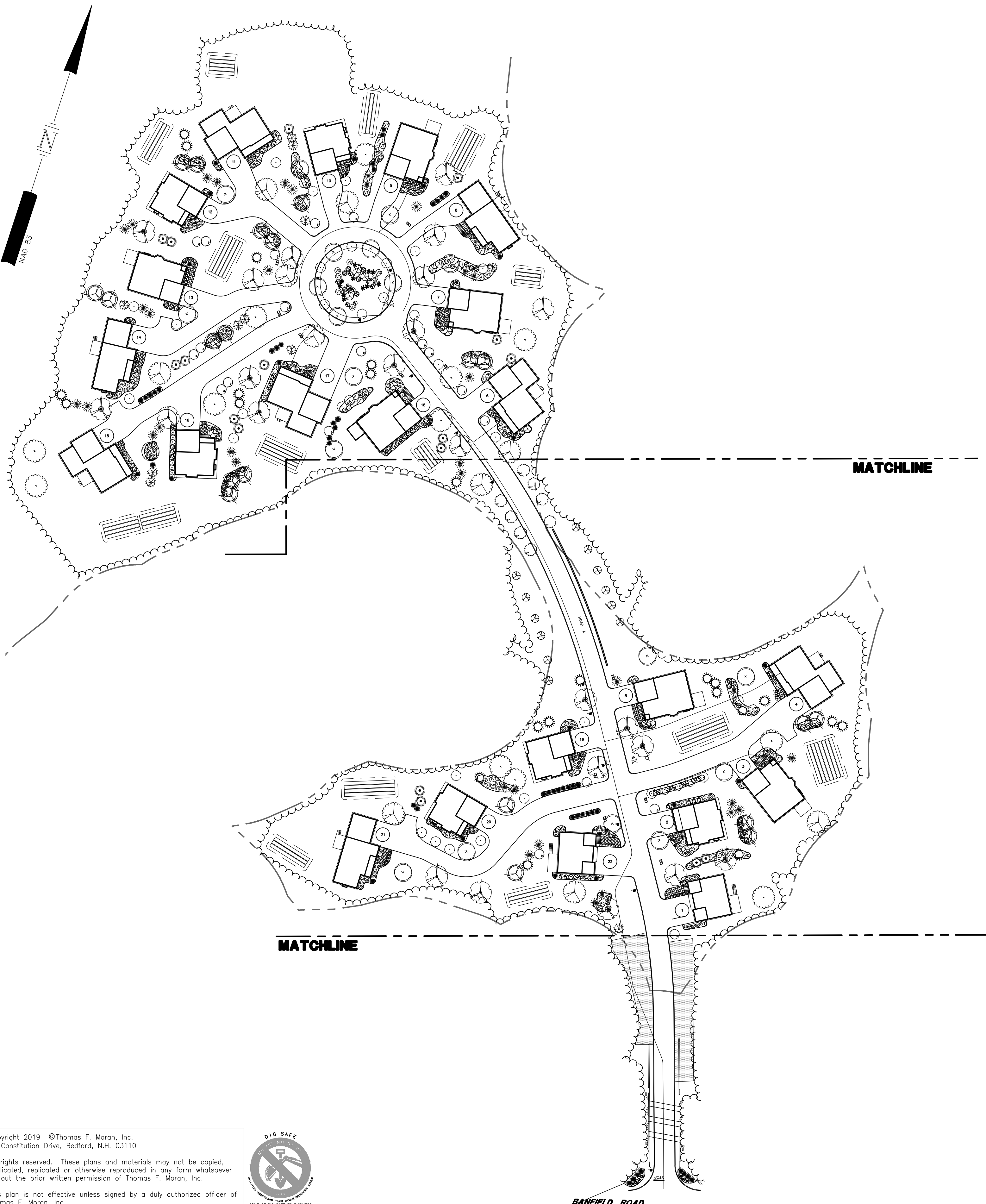

LANDSCAPE NOTES

1. CONTRACTOR WILL LOCATE, VERIFY AND MARK ALL EXISTING AND NEWLY INSTALLED UNDERGROUND UTILITIES PRIOR TO ANY LAWNWORK OR PLANTING. ANY CONFLICTS WHICH MIGHT OCCUR BETWEEN PLANTING AND UTILITIES WILL IMMEDIATELY BE REPORTED TO THE LANDSCAPE ARCHITECT OR OWNERS' REPRESENTATIVE, SO THAT ALTERNATE PLANTING LOCATIONS CAN BE DETERMINED.
2. CONTRACTOR WILL FURNISH AND PLANT ALL PLANTS IN QUANTITIES AS SHOWN ON THIS PLAN. IN CASES OF DISCREPANCY BETWEEN PLAN AND LIST CLARIFY WITH LANDSCAPE ARCHITECT PRIOR TO PLACING PURCHASE ORDER AND AGAIN PRIOR TO PLANTING.
3. SEE PLANTING DETAILS AND IF INCLUDED, SPECIFICATIONS FOR ADDITIONAL INFORMATION.
4. PLANT TYPES MAY VARY BASED ON AVAILABILITY AND SUPPLY. THIS LAYOUT REPRESENTS THE INTENT OF THE PLANTING AND APPROXIMATE NUMBERS OF PLANTS TO BE PROVIDED.
5. IT IS THE CONTRACTOR'S RESPONSIBILITY TO MAKE THE APPROPRIATE ARRANGEMENTS TO PROVIDE ALL PLANTS AND MATERIALS TO ACCOMMODATE PLANTING WITHIN THE TIME ALLOWED BY THE CONSTRUCTION SCHEDULE.
6. PLANTING SHALL BE COMPLETED FROM APRIL 15TH THROUGH OCTOBER 15TH UNLESS OTHERWISE NOTED IN SPECIFICATIONS. THERE WILL BE NO PLANTING DURING JULY AND AUGUST UNLESS SPECIAL PROVISIONS ARE MADE FOR DROUGHT BY PROVIDING ADDITIONAL WATERING.
7. ALL PLANTS WILL BE NURSERY GROWN.
8. PLANTS WILL BE IN ACCORDANCE, AT A MINIMUM, WITH CURRENT EDITION OF "AMERICAN STANDARDS FOR NURSERY STOCK" AS PUBLISHED BY THE AMERICAN HORTICULTURE INDUSTRY ASSOCIATION.
9. TREES WILL BE PRUNED IN ACCORDANCE WITH THE LATEST EDITION OF ANSI A300 PART 1, "TREE, SHRUB AND OTHER WOODY PLANT MAINTENANCE STANDARD PRACTICES".
10. PLANTS MATERIAL IS SUBJECT TO APPROVAL / REJECTION BY THE LANDSCAPE ARCHITECT AT THE SITE AND AT THE NURSERY.
11. ALL PLANTS WILL BE MOVED WITH ROOT SYSTEMS AS SOLID UNITS AND WITH BALLS OF EARTH FIRMLY WRAPPED WITH BURLAP. NO PLANT WILL BE ACCEPTED WHEN BALL OF EARTH SURROUNDING ITS ROOTS HAS BEEN BADLY CRACKED OR BROKEN BEFORE PLANTING. ALL PLANTS THAT CANNOT BE PLANTED AT ONCE WILL BE HELED-IN BY SETTING IN THE GROUND AND COVERING THE BALLS WITH SOIL AND THEN WATERING. DURING TRANSPORT, ALL PLANT MATERIALS WILL BE WRAPPED WITH WIND PROOF COVERING.
12. NEWLY PLANTED MATERIAL WILL BEAR THE SAME RELATIONSHIP TO FINISHED GRADE AS TO THE ORIGINAL GRADE OF THE PLANT PRIOR TO DIGGING.
13. PROPOSED TREES OVERHANGING SIDEWALKS, ROADS OR PARKING WILL BEGIN BRANCHING NATURALLY (NOT PRUNED) AT 6' HEIGHT.
14. MULCH FOR PLANTED AREAS (NOT INCLUDING RAIN GARDENS) WILL BE AGED SHREDDED PINE BARK, PARTIALLY DECOMPOSED, DARK BROWN IN COLOR AND FREE OF WOOD CHIPS UNLESS OTHERWISE SHOWN.
15. PLANT MATERIAL WILL BE LOCATED OUTSIDE BUILDING DRIPLINES AND ROOF VALLEY POINTS OF CONCENTRATION TO PREVENT DAMAGE TO PLANTS. CLARIFY DISCREPANCIES WITH LANDSCAPE ARCHITECT PRIOR TO INSTALLATION.
16. ALL DISTURBED AREAS NOT TO BE PAVED OR OTHERWISE TREATED, WILL RECEIVE SIX (6) INCH LOAM AND SEED AT THE DIRECTION OF THE LANDSCAPE ARCHITECT OR OWNER'S REPRESENTATIVE.
17. TREE STAKES AND WRAP WILL REMAIN IN PLACE FOR NO LESS THAN 6 MONTHS AND NO MORE THAN 1 YEAR. CONTRACTOR WILL REMOVE.
18. ALL PLANT GROUPINGS WILL BE IN MULCH BEDS UNLESS OTHERWISE SPECIFIED OR NOTED ON PLANS. WHERE MULCHED PLANT BED ABUTS LAWN, PROVIDE TURF CUT EDGE.
19. ALL PLANT BEDS WILL INTERSECT WITH PAVEMENT AT 90 DEGREES UNLESS OTHERWISE NOTED ON PLANS.

LANDSCAPE GUARANTEE AND MAINTENANCE NOTES

1. CONTRACTOR WILL BE RESPONSIBLE FOR ALL MEANS, METHODS AND TECHNIQUES OF WATERING.
2. CONTRACTOR WILL BEGIN WATERING IMMEDIATELY AFTER PLANTING. ALL PLANTS WILL BE THOROUGHLY WATERED TWICE DURING THE FIRST 24 HOUR PERIOD AFTER PLANTING. ALL PLANTS WILL BE WATERED WEEKLY, OR MORE OFTEN, IF NECESSARY DURING THE FIRST GROWING SEASON BUT NOT LESS THAN ONE YEAR.
3. WATER ALL LAWNS AS REQUIRED. DO NOT LET NEWLY PLANTED LAWNS DRY OUT DURING THE FIRST FOUR WEEKS MINIMUM.
4. ALL NEW LAWNS WILL BE MAINTAINED AND MOWED A MINIMUM THREE (3) TIMES BEFORE REQUESTING REVIEW BY LANDSCAPE ARCHITECT OR OWNER'S REPRESENTATIVE FOR ACCEPTANCE. MAINTENANCE AND MOWING WILL CONTINUE UNTIL ACCEPTED BY LANDSCAPE ARCHITECT OR OWNER'S REPRESENTATIVE IS ISSUED IN WRITING.
5. THE CONTRACTOR WILL MAINTAIN AND GUARANTEE ALL PLANTINGS TO BE IN GOOD HEALTHY, FLOURISHING AND ACCEPTABLE CONDITION FOR A PERIOD OF ONE (1) YEAR BEGINNING AT THE DATE OF ACCEPTANCE BY THE LANDSCAPE ARCHITECT OR OWNER'S REPRESENTATIVE. ALL GRASSES, TREES AND SHRUBS THAT, IN THE OPINION OF THE LANDSCAPE ARCHITECT OR OWNER'S REPRESENTATIVE SHOWING LESS THAN 80% HEALTHY GROWTH AT THE END OF ONE (1) YEAR PERIOD WILL BE IMMEDIATELY REPLACED BY THE CONTRACTOR.
6. DECIDUOUS PLANT MATERIAL INSTALLED AFTER SEPTEMBER 30 AND BEFORE APRIL 15 WILL NOT BE REVIEWED THAT SEASON FOR ACCEPTANCE DUE TO STAGE OF LEAF PHYSIOLOGY. THIS PLANT MATERIAL WILL NOT BE REVIEWED UNTIL FOLLOWING GROWING SEASON. GUARANTEE PERIOD WILL BEGIN ONLY AFTER ACCEPTANCE BY LANDSCAPE ARCHITECT OR OWNER'S REPRESENTATIVE.
7. EVERGREEN PLANT MATERIAL INSTALLED AFTER OCTOBER 30 AND BEFORE APRIL 15 WILL NOT BE REVIEWED THAT SEASON FOR ACCEPTANCE DUE TO END OF GROWTH SEASON. THIS PLANT MATERIAL WILL NOT BE REVIEWED UNTIL FOLLOWING GROWING SEASON. GUARANTEE PERIOD WILL BEGIN ONLY AFTER ACCEPTANCE BY LANDSCAPE ARCHITECT OR OWNER'S REPRESENTATIVE.

HYDROSEEDING NOTES

1. HYDROSEEDING MAY BE USED AS AN ALTERNATE METHOD OF SEEDING. THE APPLICATION OF LIMESTONE AS NECESSARY, FERTILIZER AND GRASS SEED MAY BE ACCOMPLISHED IN ONE OPERATION BY THE USE OF A SPRAYING MACHINE APPROVED BY THE LANDSCAPE ARCHITECT OR CIVIL ENGINEER. THE MATERIALS SHALL BE MIXED WITH WATER IN THE MACHINE AND SHALL CONFORM TO RELATIVE REQUIREMENTS OF SECTION 644 OF NH. STANDARD SPECIFICATIONS FOR ROAD AND BRIDGE CONSTRUCTION.
2. (FOR MASSACHUSETTS PROJECTS PLUG IN - SECTION 765.65 OF MASS. DPW CURRENT STANDARD SPECIFICATIONS FOR HIGHWAYS AND BRIDGES).

INVASIVE PLANT NOTES

1. EXISTING NON-NATIVE, INVASIVE PLANT SPECIES WILL BE IDENTIFIED, REMOVED, DESTROYED AND LEGALLY DISPOSED OF OFF-SITE IN ACCORDANCE WITH THE LATEST UNIVERSITY OF NEW HAMPSHIRE COOPERATIVE EXTENSION METHODS OF DISPOSING NON-NATIVE INVASIVE PLANTS. SEE "MANAGE AND CONTROL INVASIVES" AND PROPERLY DISPOSE OF INVASIVE PLANTS".

PRICING & CONSTRUCTION DOCUMENT NOTES

1. CONTRACTOR WILL PRICE PLANT MATERIAL IN QUANTITIES SUFFICIENT TO COMPLETE PLANTINGS GRAPHICALLY SHOWN ON THESE DRAWINGS OR IN PLANT LIST, WHICHEVER IS GREATER. IN CASES OF DISCREPANCY BETWEEN PLAN AND LIST CLARIFY WITH LANDSCAPE ARCHITECT PRIOR TO PLACING PURCHASE ORDER AND AGAIN PRIOR TO PLANTING.
2. CONTRACTOR WILL VERIFY PRIOR TO PRICING IF SITE SOILS ARE VERY POORLY DRAINING OR IF LEDGE IS PRESENT. IF CONTRACTOR ENCOUNTERS VERY POORLY DRAINING SOILS (BATH TUB EFFECT) OR LEDGE THAT IMPACTS PROPOSED PLANTING PLAN, NOTIFY LANDSCAPE ARCHITECT OR OWNERS' REPRESENTATIVE FOR DIRECTION PRIOR TO PRICING AND AGAIN PRIOR TO PERFORMING ANY WORK.
3. CONTRACTOR WILL STAKE OR PLACE ON GROUND ALL PROPOSED PLANT MATERIALS PER PLAN. CONTACT LANDSCAPE ARCHITECT FOR REVIEW AND APPROVAL PRIOR TO INSTALLATION.
4. COORDINATE WITH LANDSCAPE ARCHITECT'S CONTRACTED NUMBER OF SITE VISITS WHEN PLANNING FOR INSPECTION. NOTIFY LANDSCAPE ARCHITECT 72 HOURS MINIMUM IN ADVANCE OF REQUESTED SITE VISIT.
5. CONTRACTOR WILL DEVELOP A WRITTEN WATERING SCHEDULE AND WILL SUBMIT WATERING SCHEDULE TO OWNERS' REPRESENTATIVE. CONTRACTOR WILL WATER ALL NEW PLANTS INCLUDING LAWNS THAT ARE NOT "IRRIGATED" VIA A PERMANENT IRRIGATION SYSTEM FOR THE FIRST 12 MONTHS.

PORTSMOUTH NOTES

1. THE PROPERTY OWNER AND ALL FUTURE PROPERTY OWNER'S WILL BE RESPONSIBLE FOR THE MAINTENANCE AND OF ALL REQUIRED SCREENING AND LANDSCAPE MATERIALS INDICATED ON THESE PLANS.
- 2.
3. ALL REQUIRED PLANT MATERIAL WILL BE TENDED TO AND KEPT FREE OF REFUSE AND DEBRIS.
4. ALL REQUIRED FENCES AND WALLS WILL BE MAINTAINED IN GOOD REPAIR.
5. THE PROPERTY OWNER WILL BE RESPONSIBLE TO REMOVE AND REPLACE DEAD OR DISEASED PLANT MATERIALS IMMEDIATELY WITH THE SAME TYPE, SIZE AND QUANTITY OF PLANT MATERIALS AS ORIGINALLY INSTALLED. UNLESS ALTERNATIVE PLANTINGS ARE REQUESTED, JUSTIFIED AND APPROVED BY THE PLANNING BOARD OR PLANNING DIRECTOR.
6. ALL IMPROVEMENTS SHOWN ON THIS PLAN WILL BE CONSTRUCTED AND MAINTAINED IN ACCORDANCE WITH THIS PLAN BY THE PROPERTY OWNER AND ALL FUTURE PROPERTY OWNERS. NO CHANGES WILL BE MADE TO THIS PLAN WITHOUT THE WRITTEN APPROVAL OF THE PORTSMOUTH PLANNING BOARD OR PLANNING DIRECTOR.
7. THE LANDSCAPE PLAN WILL BE RECORDED IN THE ROCKINGHAM COUNTY REGISTRY OF DEEDS.

SEEDING NOTES

1. SLOPES UP TO AND INCLUDING 3:1 GRADE, SEED WILL BE NEW ENGLAND EROSION CONTROL & RESTORATION MIX PER NEW ENGLAND WETLANDS PLANTS INC., AMHERST, MA.
2. SLOPES STEEPER THAN 3:1 GRADE, SEED WILL BE NEW ENGLAND EROSION CONTROL & RESTORATION MIX PER NEW ENGLAND WETLANDS PLANTS INC., AMHERST, MA. SEE CIVIL FOR ADDITIONAL EROSION CONTROL MEASURES.
3. GENERAL SEED WILL BE NHDOT SPECIFICATION SECTION 644, TABLE 644-1-PARK SEED TYPE 15, INCLUDING NOTES TO TABLE 1, 2 & 3.

SITE DEVELOPMENT PLANS

TAX MAP 256 LOT 2
OVERALL LANDSCAPE PLAN
THE VILLAGE AT BANFIELD WOODS
PORTSMOUTH, NH
 OWNED BY
WALTER D HETT TRUST
 PREPARED FOR
GREEN & COMPANY REAL ESTATE
1"=120' (11"X17")
SCALE: 1"=60' (22"X34") **SEPTEMBER 25, 2019**

Copyright 2019 © Thomas F. Moran, Inc.
 48 Constitution Drive, Bedford, N.H. 03110
 All rights reserved. These plans and materials may not be copied, duplicated, replicated or otherwise reproduced in any form whatsoever without the prior written permission of Thomas F. Moran, Inc.
 This plan is not effective unless signed by a duly authorized officer of Thomas F. Moran, Inc.

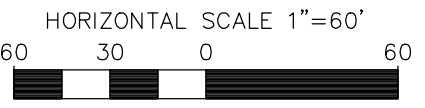

REV	DATE	DESCRIPTION	DR	CK
6	5/5/2020	REVISE NOTE PER CLIENT REQUEST	MSK	JJM
1	12/23/19	NO REVISIONS THIS SHEET	RCK	JJM

	Civil Engineers Structural Engineers Traffic Engineers Land Surveyors Landscape Architects Scientists			48 Constitution Drive Bedford, NH 03110 Phone (603) 472-4488 Fax (603) 472-9747 www.tfmoran.com	
	47361.00	DR MSK CK JUM	FB CADFILE	LANDSCAPE	
					C-16

May 06, 2020 - 11:12am F:\MISC Projects\47361 - Portsmouth\47361-00 - Green & Co - Banfield Road\Design\Production Drawings\Landscape.dwg

MATCHLINE

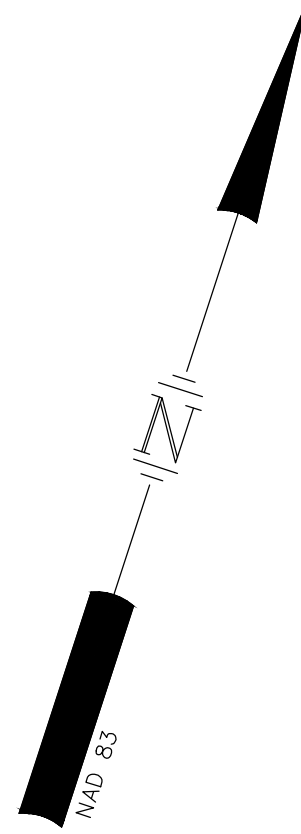
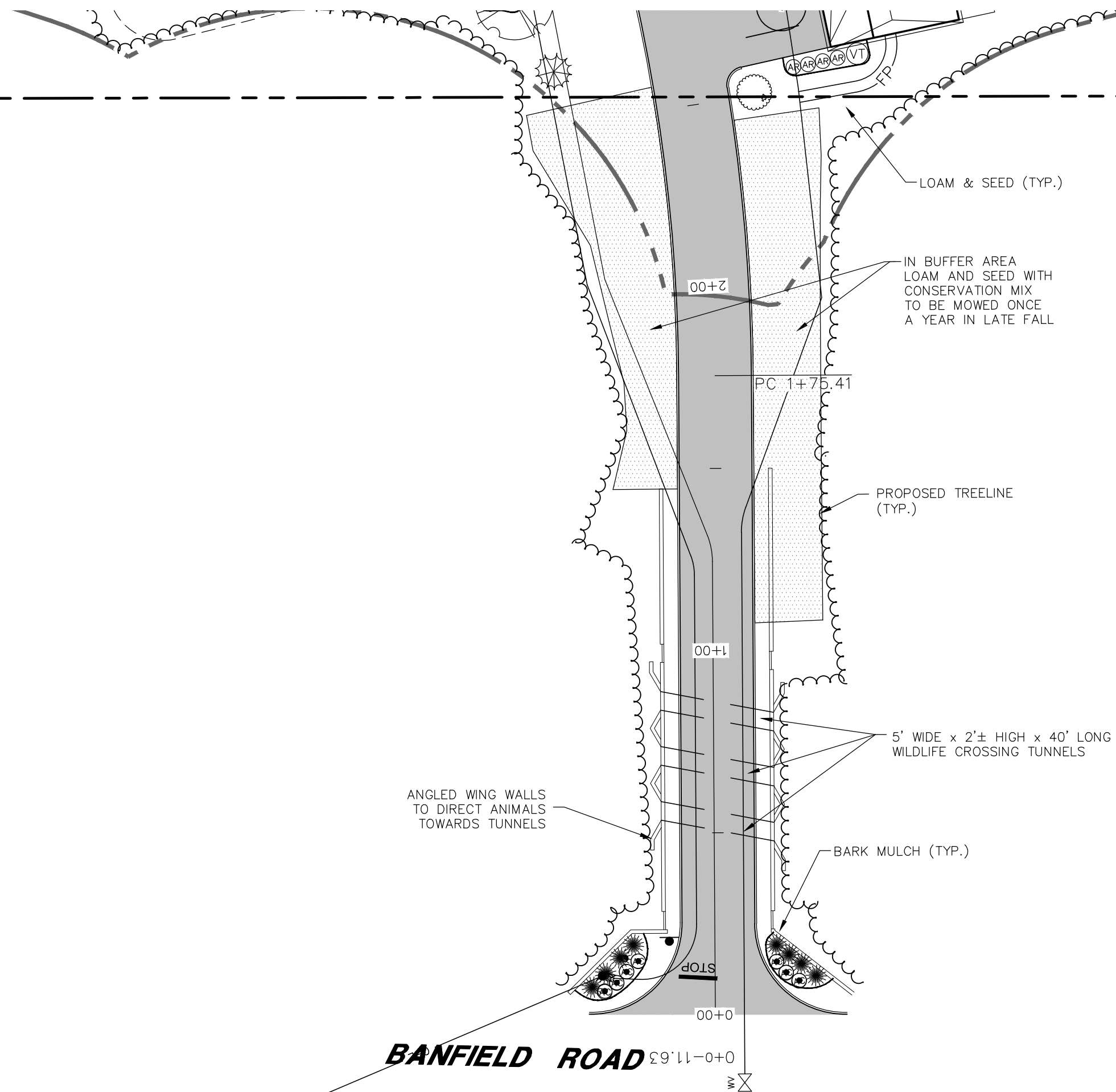

LANDSCAPE LEGEND

SYMBOL	QTY	BOTANICAL NAME COMMON NAME	SIZE	REMARKS
SHADE TREES				
	12	ACER RUBRUM 'OCTOBER GLORY' **OCTOBER GLORY RED MAPLE	3" TO 3 1/2" CAL.	B&B
	10	ACER SACCHARUM 'COMMEMORATION' **COMMEMORATION SUGAR MAPLE	3" TO 3 1/2" CAL.	B&B
	20	BETULA N. 'HERITAGE' *RIVER BIRCH	12' TO 14' CLUMP	B&B
	20	NYSSA SYLVATICA *BLACK GUM	2 1/2 TO 3" CAL.	B&B
	12	QUERCUS ALBA *WHITE OAK	3" TO 3 1/2" CAL.	B&B
	11	QUERCUS RUBRA *RED OAK	3" TO 3 1/2" CAL.	B&B

LANDSCAPE LEGEND

SYMBOL	QTY	BOTANICAL NAME COMMON NAME	SIZE	REMARKS
SMALL/FLOWERING TREES				
	8	CARPINUS CAROLINIANA *AMERICAN HORNBEAM	2' TO 2 1/2" CAL.	B&B
	36	CRATAEGUS CRUSGALLI INERMIS **THORNLESS COCKSPUR HAWTHORN	2 1/2" TO 3" CAL.	B&B
	22	PRUNUS VIRGINIANA 'SCHUBERT' *CANADA RED CHERRY	2 1/2" TO 3" CAL.	B&B
EVERGREEN TREES				
	17	ABIES BALSAMAE *BALSAM FIR	6' TO 7'	B&B
	11	JUNIPERUS VIRGINIANA *EASTERN RED CEDAR	6' TO 7'	B&B
	35	PICEA GLAUCA *WHITE SPRUCE	7' TO 8'	B&B
	23	PINUS STROBUS *WHITE PINE	6' TO 7'	B&B

LANDSCAPE LEGEND

SYMBOL	QTY	BOTANICAL NAME COMMON NAME	SIZE	REMARKS
DECIDUOUS SHRUB				
	24	AMELANCHEIR CANADENSIS *SHADBLOW SERVICEBERRY	5' TO 6' CLUMP	B&B
	33	CLETHRA ALNIFOLIA 'COMPACTA' **COMPACT SUMMERSWEET	7 GAL.	CONT.
	51	CORNUS SERICEA 'ALLEMAN'S COMPACTA' **ALLEMAN'S COMPACT RED-OSIER DOGWOOD	3' TO 4'	CONT.
	48	PHYSOCARPUS O. 'BURGUNDY CANDY' **BURGUNDY CANDY NINEBARK	2 GAL.	CONT.
	14	VIBURNUM DENTATUM *ARROWWOOD VIBURNUM	4' TO 5'	B&B
	17	VIBURNUM TRILOBUM *AMERICAN CRANBERRY VIBURNUM	4' TO 5'	B&B
	3	VIBURNUM PRUNIFOLIUM *BLACKHAW VIBURNUM	4' TO 5'	B&B

LANDSCAPE LEGEND

SYMBOL	QTY	BOTANICAL NAME COMMON NAME	SIZE	REMARKS
EVERGREEN SHRUB				
	23	ARCTOSTAPHYLOS UVA-URSI *BEARBERRY	1 GAL.	CONT.
	26	AZALEA 'GIRARD'S CRIMSON' GIRARD'S CRIMSON AZALEA	3 GAL.	CONT.
	26	AZALEA 'GIRARD'S RENEE MICHELE' GIRARD'S RENEE MICHELE AZALEA	3 GAL.	CONT.
	30	RHODODENDRON 'ROSEUM PINK' **ROSEUM PINK CATAWBA RHODODENDRON	7 GAL.	CONT.
	20	ILEX GLABRA 'COMPACTA' **COMPACT INKBERRY	3 GAL.	CONT.
	25	JUNIPERUS H. 'BAR HARBOR' *BAR HARBOR JUNIPER	3 GAL.	CONT.
	121	JUNIPERUS C. 'ANGELICA BLUE' ANGELICA BLUE JUNIPER	5 GAL.	CONT.
	14	PINUS M. 'MOPS' MOPS MUGO PINE	3 GAL.	CONT.
	65	THUJA O. NIGRA *DARK AMERICAN ARBORVITAE	5' TO 6'	B&B

*NATIVE
**IMPROVED NATIVE
NOTE:
PLANT TYPES MAY VARY BASED ON AVAILABILITY AND SUPPLY. THIS LAYOUT REPRESENTS THE INTENT OF THE PLANTINGS AND APPROXIMATE NUMBERS OF PLANTS TO BE PROVIDED.

SYMBOL	QTY	BOTANICAL NAME COMMON NAME	SIZE	REMARKS
GRASSES AND GRASS MIXES				
	11	PANICUM VIRGATUM 'CLOUD NINE' CLOUD NINE SWITCH GRASS	3 GAL.	CONT.
	3 LBS	NEW ENGLAND CONSERVATION WILDLIFE MIX	25 LBS/ACRE	BULK LBS

SITE DEVELOPMENT PLANS

TAX MAP 256 LOT 2
LANDSCAPE PLAN
THE VILLAGE AT BANFIELD WOODS
PORTSMOUTH, NH

OWNED BY
WALTER D HETT TRUST

PREPARED FOR
GREEN & COMPANY REAL ESTATE

1"=60' (11'X17')

SCALE: 1"=30' (22'X34")

SEPTEMBER 25, 2019



Civil Engineers
Structural Engineers
Traffic Engineers
Land Surveyors
Landscape Architects
Scientists

48 Constitution Drive
Bedford, NH 03110
Phone (603) 472-4488
Fax (603) 472-9747
www.tfmoran.com



REV	DATE	DESCRIPTION	DR	CK
6	5/5/2020	REVISE NOTE PER CLIENT REQUEST	MSK	JJM
3	3/4/2020	UPDATE PLANS PER REGULATORY COMMENTS	RCK	JJM
2	12/27/2019	IN HOUSE REVISIONS	RCK	JJM
1	12/23/19	NO REVISIONS THIS SHEET	RCK	JJM

FILE	47361.00	DR	MSK	FB			
		CK	JJM	CADFILE	LANDSCAPE		
							C-17

May 06, 2020 - 11:12am F:\MISC Projects\47361 - Portsmouth\47361-00 - Green & Co - Banfield Road\Design\Production Drawings\Landscape.dwg

Copyright 2019 © Thomas F. Moran, Inc.
48 Constitution Drive, Bedford, N.H. 03110
All rights reserved. These plans and materials may not be copied, duplicated, replicated or otherwise reproduced in any form whatsoever without the prior written permission of Thomas F. Moran, Inc.
This plan is not effective unless signed by a duly authorized officer of Thomas F. Moran, Inc.



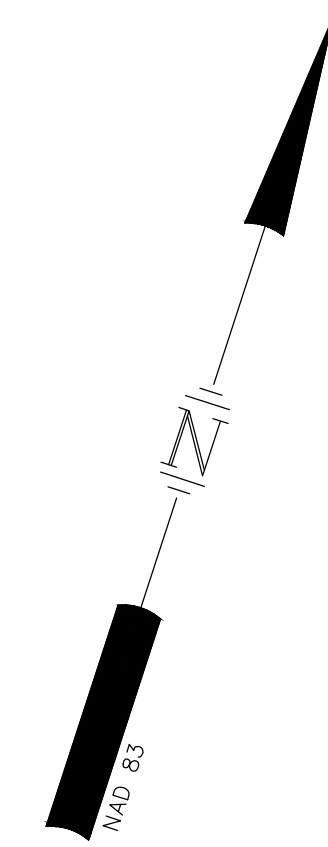

SITE DEVELOPMENT PLANS

TAX MAP 256 LOT 2
LANDSCAPE PLAN
THE VILLAGE AT BANFIELD WOODS
PORTSMOUTH, NH
 OWNED BY
WALTER D HETT TRUST
 PREPARED FOR
GREEN & COMPANY REAL ESTATE
1"=60' (11'X17")
SCALE: 1"=30' (22'X34") **SEPTEMBER 25, 2019**

Copyright 2019 ©Thomas F. Moran, Inc.
 48 Constitution Drive, Bedford, N.H. 03110
 All rights reserved. These plans and materials may not be copied, duplicated, replicated or otherwise reproduced in any form whatsoever without the prior written permission of Thomas F. Moran, Inc.
 This plan is not effective unless signed by a duly authorized officer of Thomas F. Moran, Inc.

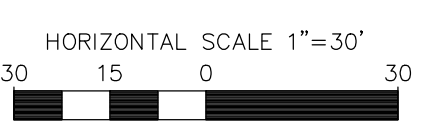

REV	DATE	DESCRIPTION	DR	CK
6	5/5/2020	REVISE NOTE PER CLIENT REQUEST	MSK	JJM
3	3/4/2020	UPDATE PLANS PER REGULATORY COMMENTS	RCK	JJM
2	12/27/2019	IN HOUSE REVISIONS	RCK	JJM
1	12/23/19	NO REVISIONS THIS SHEET	RCK	JJM

	Civil Engineers Structural Engineers Traffic Engineers Land Surveyors Landscape Architects Scientists			48 Constitution Drive Bedford, NH 03110 Phone (603) 472-4488 Fax (603) 472-9747 www.tfmoran.com		
	47361.00	DR MSK CK JJM	FB CADFILE	- LANDSCAPE	C-18	

May 06, 2020 - 11:13am
 F:\MISC Projects\47361 - Portsmouth\47361-00 - Green & Co - Banfield Road\Design\Production Drawings\Landscape.dwg

May 06, 2020 - 11:13am
 F:\MISC Projects\47361 - Portsmouth - Green & Co - Banfield Road\Design\Production Drawings\Landscapes.dwg

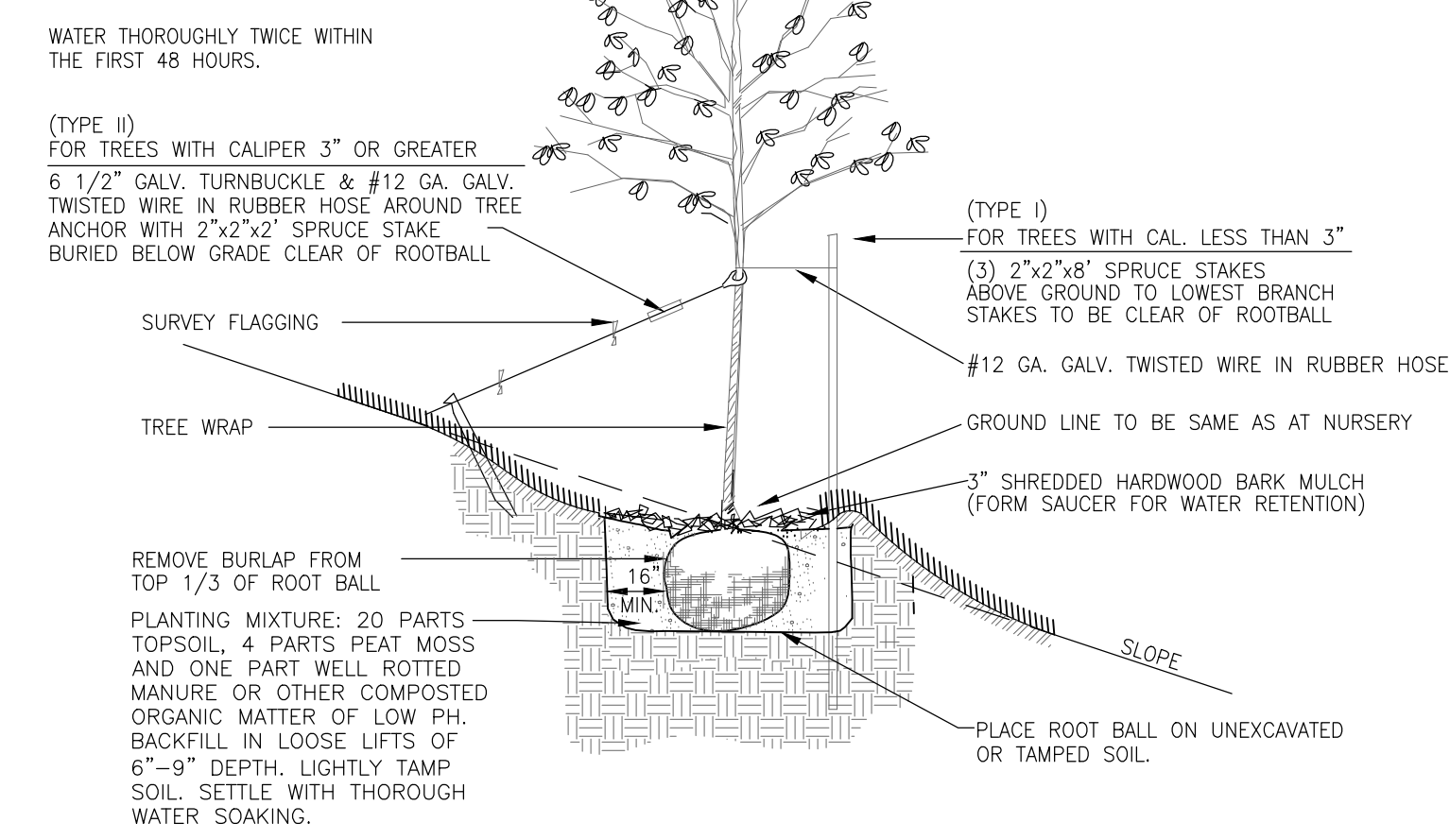
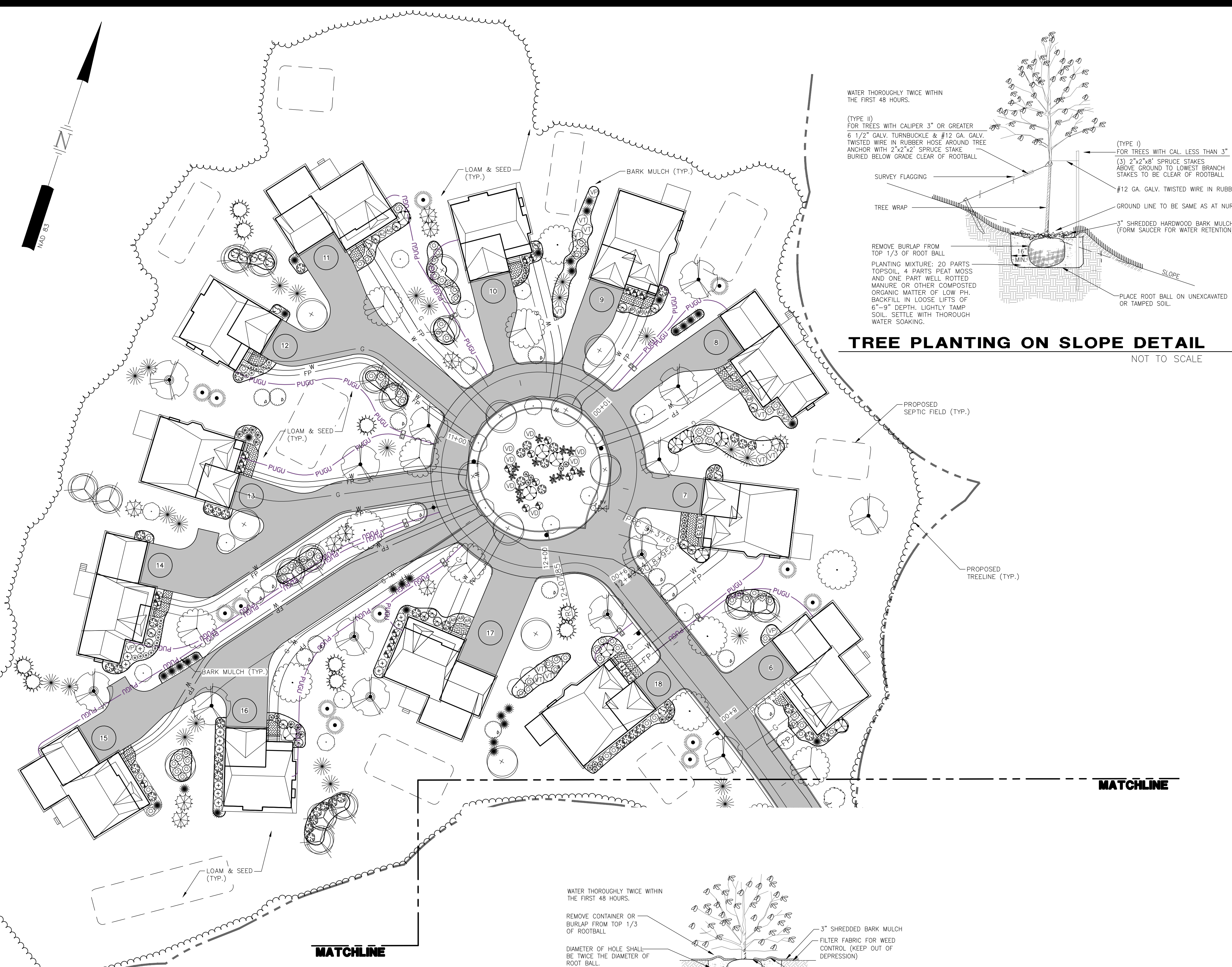

TREE PLANTING ON SLOPE DETAIL
 NOT TO SCALE

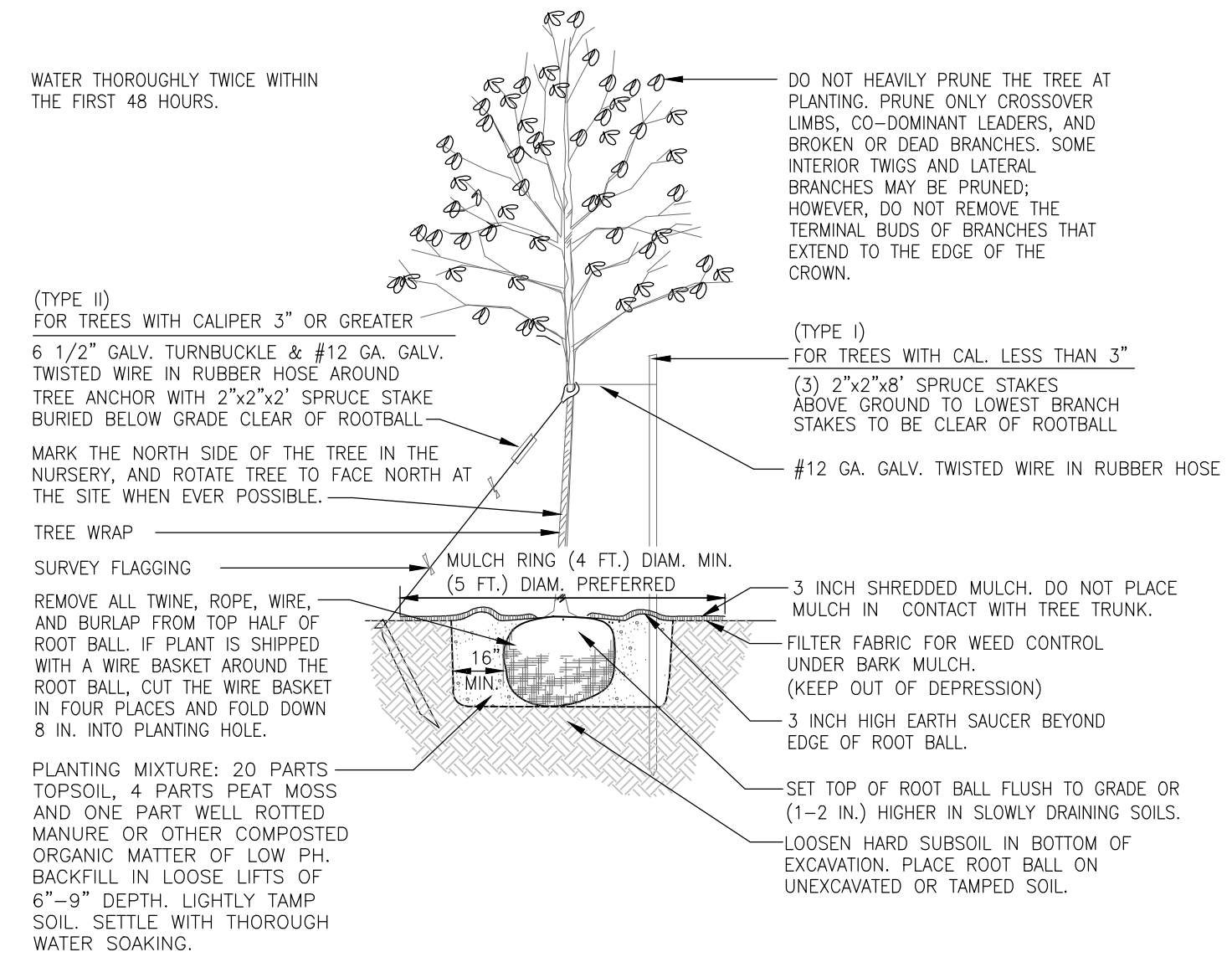

DECIDUOUS TREE PLANTING
 NOT TO SCALE

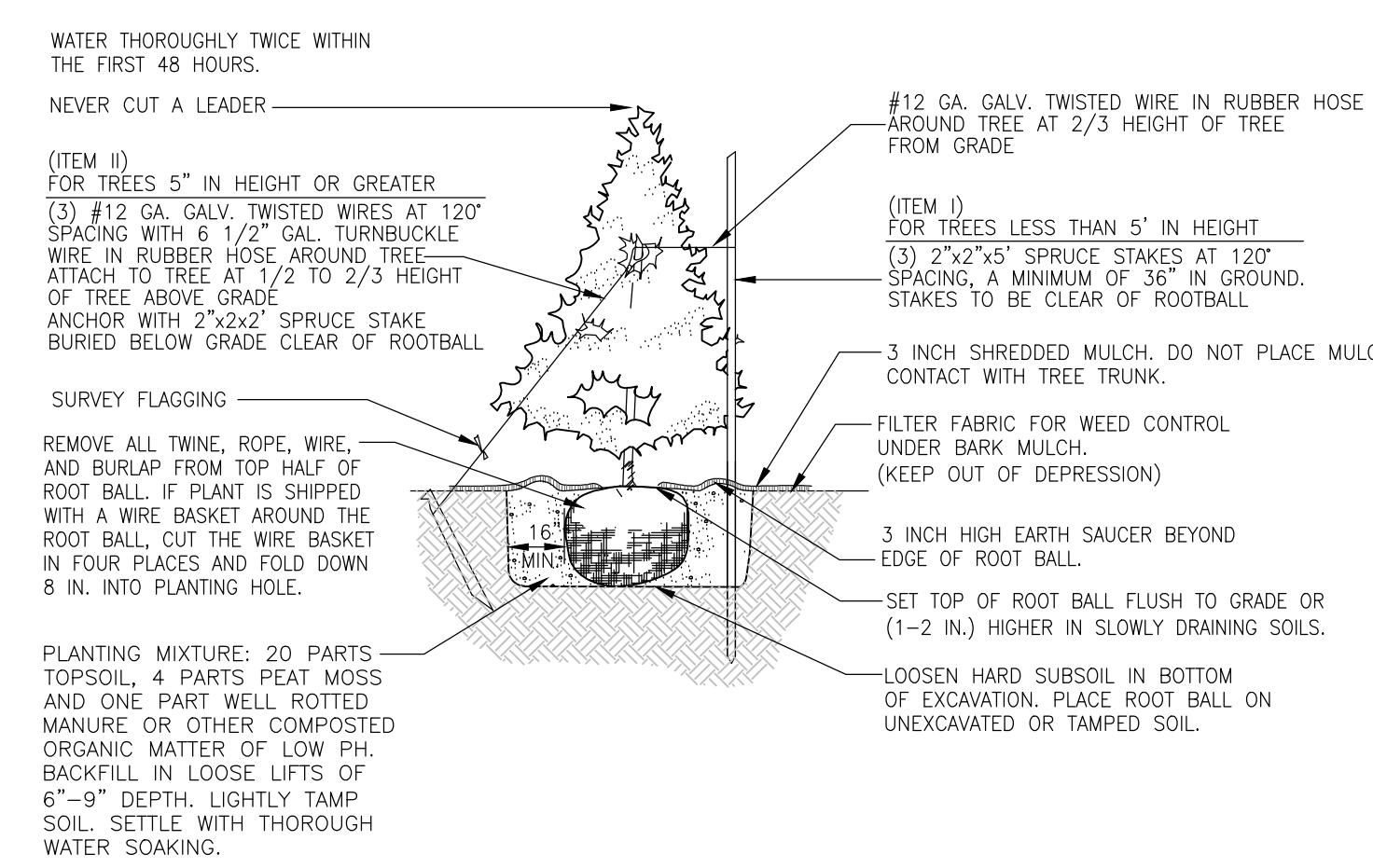

EVERGREEN PLANTING
 NOT TO SCALE

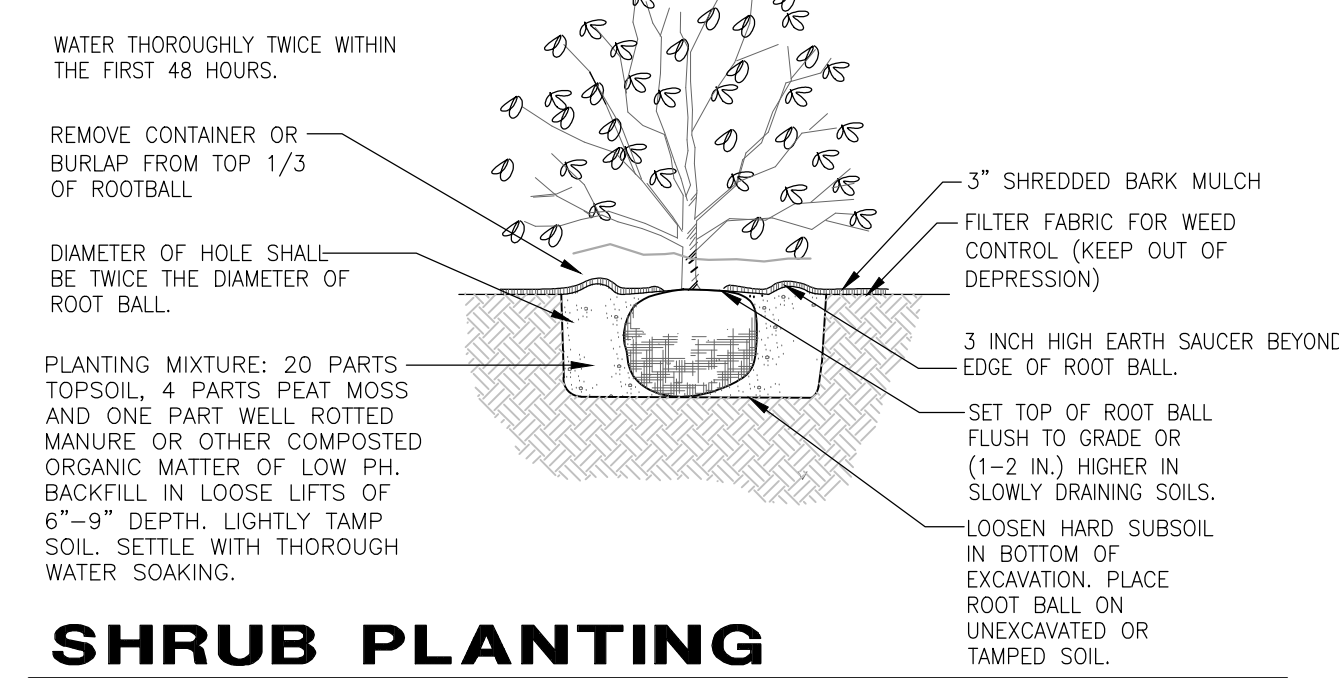

SHRUB PLANTING
 NOT TO SCALE

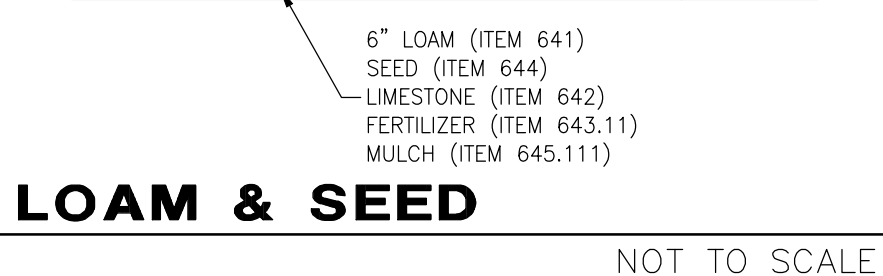

LOAM & SEED
 NOT TO SCALE

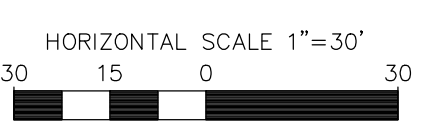

REV	DATE	DESCRIPTION	DR	CK
6	5/5/2020	REVISE NOTE PER CLIENT REQUEST	MSK	JJM
3	3/4/2020	UPDATE PLANS PER REGULATORY COMMENTS	RCK	JJM
2	12/27/2019	IN HOUSE REVISIONS	RCK	JJM
1	12/23/19	NO REVISIONS THIS SHEET	RCK	JJM

SITE DEVELOPMENT PLANS
 TAX MAP 256 LOT 2
LANDSCAPE PLAN
THE VILLAGE AT BANFIELD WOODS
PORTSMOUTH, NH
 OWNED BY
WALTER D HETT TRUST
 PREPARED FOR
GREEN & COMPANY REAL ESTATE
1"=60' (11"X17")
SCALE: 1"=30' (22"X34") **SEPTEMBER 25, 2019**

TFM Civil Engineers
 Structural Engineers
 Traffic Engineers
 Land Surveyors
 Landscape Architects
 Scientists

48 Constitution Drive
 Bedford, NH 03110
 Phone (603) 472-4488
 Fax (603) 472-9747
 www.tfmoran.com

47361.00 DR MSK FB
 CK JUM CADFILE LANDSCAPE

C-19

Copyright 2019 © Thomas F. Moran, Inc.
 48 Constitution Drive, Bedford, N.H. 03110
 All rights reserved. These plans and materials may not be copied, duplicated, replicated or otherwise reproduced in any form whatsoever without the prior written permission of Thomas F. Moran, Inc.
 This plan is not effective unless signed by a duly authorized officer of Thomas F. Moran, Inc.

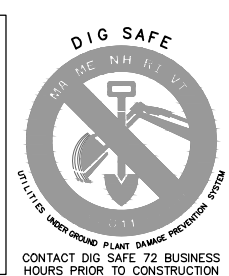

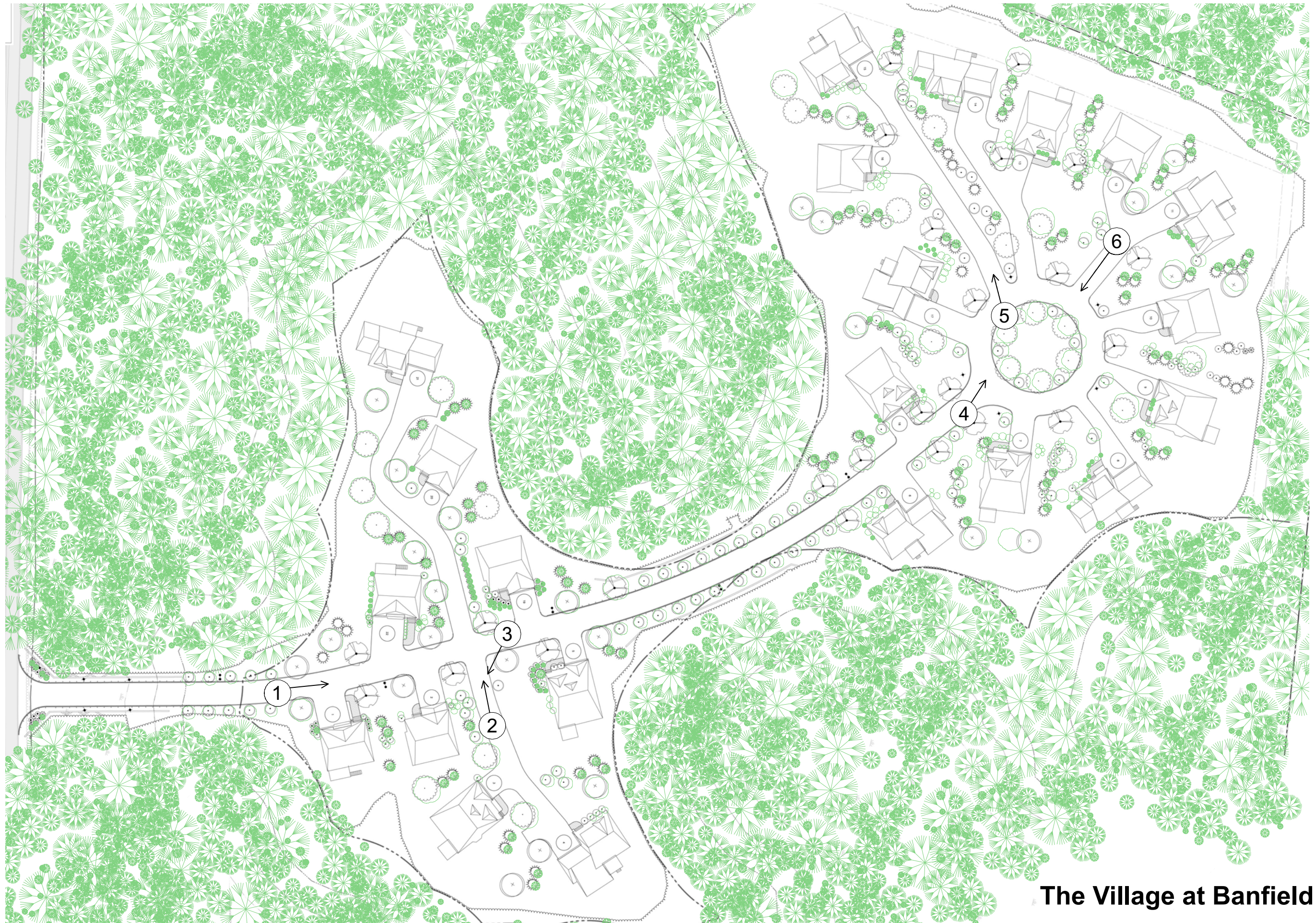

The Village at Banfield Woods



©2019 Art Form Architecture
The Village at Banfield Woods

The Village at Banfield Woods



©2019 Art Form Architecture
The Village at Banfield Woods

The Village at Banfield Woods



©2019 Art Form Architecture
The Village at Banfield Woods

The Village at Banfield Woods



©2019 Art Form Architecture
The Village at Banfield Woods

The Village at Banfield Woods



©2019 Art Form Architecture
The Village at Banfield Woods

The Village at Banfield Woods



©2019 Art Form Architecture
The Village at Banfield Woods

The Village at Banfield Woods

Photography: Oleo Woods, Newburyport

Green & Company Subdivision

26 Units on 6.3 Acres

39.7 Acres Left in Open Space



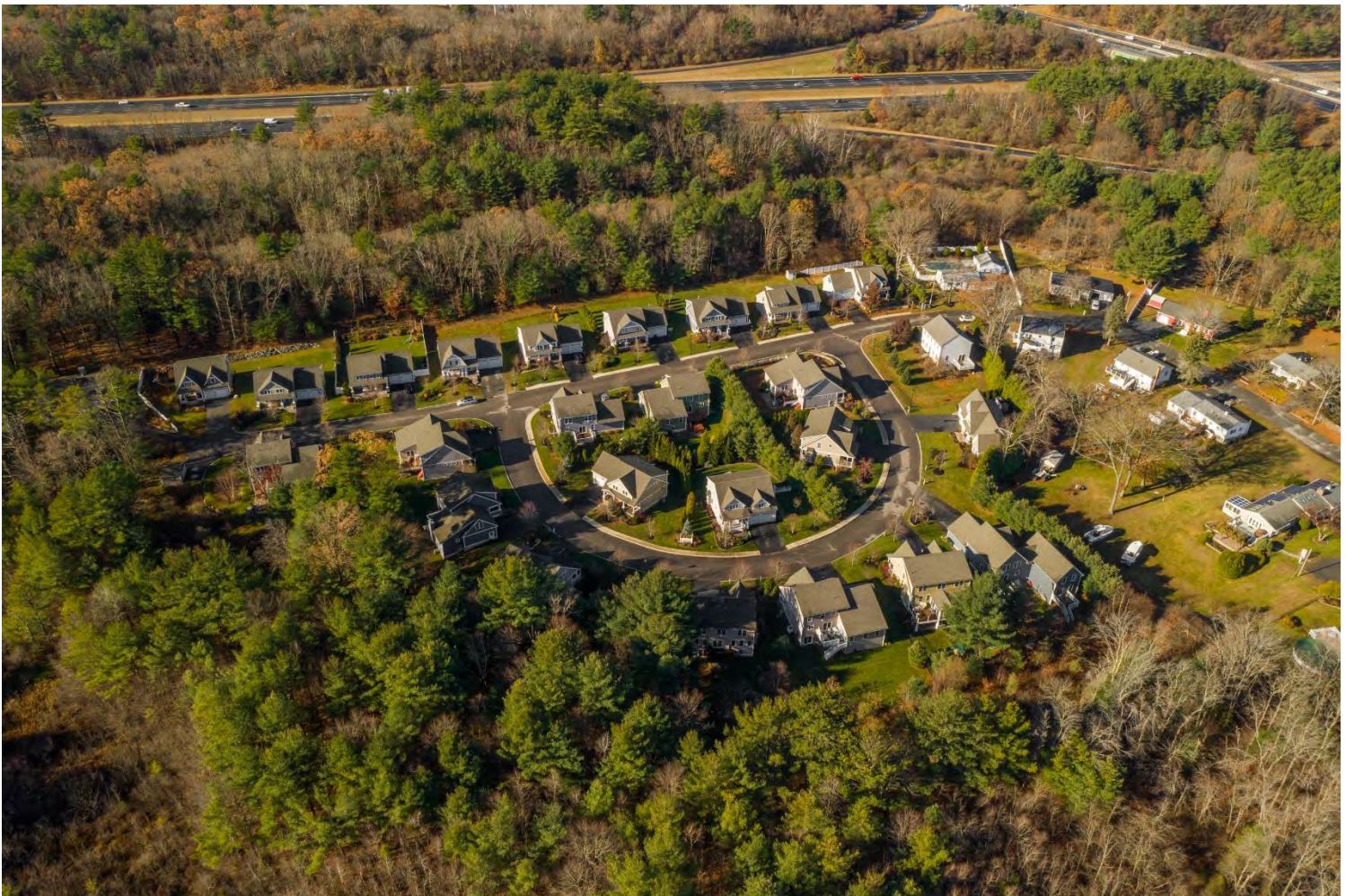



Civil Engineers
 Structural Engineers
 Traffic Engineers
 Land Surveyors
 Landscape Architects
 Scientists

**Tree Count in Wetland Buffer Impact Areas
 for New Design (over 6" DBH)**

12/2/2019

Project # 47361.00 - Map 256 Lot 2

0 Banfield Road Portsmouth, NH

Trees within 0'-25' of Wetland Buffer

Tree	Count
6" Oak	1
6" Maple	1
8" Maple	1
26" White Pine	1
Total Trees	4

Trees within 25'-100' of Wetland Buffer

Tree	Count
6" Oak	1
7" Oak	3
8" Oak	4
12" Oak	6
13" Oak	1
14" Oak	1
16" Oak	2
18" Oak	1
8" White Pine	1
9" White Pine	2
7" White Pine	1
10" White Pine	2
12" White Pine	3
8" Beech	4
Total Trees	32

Total Trees within Wetland Buffer	36
--	-----------

This total reduced from 91 (see back page)



Civil Engineers
 Structural Engineers
 Traffic Engineers
 Land Surveyors
 Landscape Architects
 Scientists

**Tree Count in Wetland Buffer Impact Areas
 for Previous Design (over 6" DBH)**

Project # 47361.00 - Map 256 Lot 2
 0 Banfield Road Portsmouth, NH

Trees within 0'-25' of Wetland Buffer

Tree	Count
14" Oak	1
18" Oak	1
9" Maple	1
11" Poplar	1
Total Trees	4

Trees within 25'-100' of Wetland Buffer

Tree	Count
6" Oak	1
7" Oak	3
8" Oak	5
9" Oak	5
10" Oak	2
11" Oak	4
12" Oak	7
13" Oak	4
14" Oak	7
15" Oak	6
16" Oak	4
18" Oak	2
23" Oak	1
6" Maple	2
7" Maple	4
8" Maple	4
9" Maple	1
10" Maple	1
6" Beech	1
8" Beech	2
12" Poplar	1
15" Poplar	1
6" White Pine	2
7" White Pine	4
8" White Pine	1
9" White Pine	1
10" White Pine	4
11" White Pine	2
12" White Pine	1
13" White Pine	1
15" White Pine	1
19" White Pine	1
22" White Pine	1
Total Trees	87

Total Trees within Wetland Buffer	91
--	-----------



Strategic Resource | Proven Results

One Willow Lane, Rye NH 03870

June 23, 2020

Dear Juliet and Portsmouth Planning Board Members,

Green & Company has retained August Consulting, PLLC to complete a Peer Review of the response to TAC comments and the Planning Board submission package prepared by T.F. Moran for the proposed Village at Banfield Woods. I have reviewed the complete submission package prepared by TF Moran including the multiple consultant independent reviews. In addition, I have viewed the TAC and Conservation Commission meeting videos and reviewed staff and CMA comments.

Executive Summary

I am familiar with the various projects that Green & Company has developed around the Seacoast over the past 30+ years, but this is the first opportunity I have had to work with them. I am impressed with the level of thought and detail that has gone into the project layout and plan development. In addition, the peer review consultants they have retained have prepared thorough plan reviews.

I note the following project highlights:

- Avoidance and minimization to wetland impacts and wetland buffers
- Thoughtfully designed roadway and community layout
- Extensive proposed landscaping
- Appropriate and effective low-impact stormwater design
- Preservation of open space
- Wildlife measures incorporated into the design

Landscaping and Density: The landscaping plan, sheet C-17 details the installation of 237 trees and 550 shrubs and bushes. The landscaping narrative explains how the variety of plants and bushes were chosen to provide seasonal colors and screening, and how the houses were situated to maximize the privacy between residences. The landscape architect has done a nice job creating attractive tree lined roadways and driveways and providing a variety of vegetation that will provide privacy screening between the neighborhoods. The design team has done a notable job of minimizing buffer impacts.

According to the Site Data summary provided by TF Moran on sheet S-04, 22 units are proposed where 23 are allowed. In addition, the dimensional requirements on sheet S-03 state that 95% open space is provided, far exceeding the 25% requirement. Only 2% building coverage is proposed where up to 10% is allowed. The combination of the large amount of open space and enhanced landscaping translates into less stormwater runoff.

Stormwater Management: I have reviewed the Staff and Peer review comments on the stormwater management system effectiveness, installation process, operation and maintenance. I have reviewed the installation procedures prepared by Professional Engineers at TF Moran with input from Severino Trucking, as well as the manufacturer's information on installation, reliability and treatment results.

Furthermore, Green & Company has retained Dr. Rob Roseen, Waterstone Engineering, a respected stormwater expert to perform a peer review. Also, Keach-Nordstrom prepared a second peer review of the system. In addition to the 3 professional engineering reviews by Green & Company consultants, I have read the CMA correspondence. Additionally, the system is being-reviewed by the New Hampshire Department of Environmental Services as part of the Alteration of Terrain permit process.

The design review of the stormwater system by 5 different consultants/engineers should give the City confidence that the system has been properly reviewed. In my opinion the stormwater design, installation and operation has been properly vetted and the design team has come up with a solution that minimizes site disturbance, eliminates buffer impacts, provides the most comprehensive treatment of stormwater, is easy to maintain, has a reliability record and is not creating a potential safety hazard for residents.

Wildlife and Wetlands: I understand from reading the TAC and Conservation Commission comments and watching videos of prior meetings, there has been discussion on wildlife impacts. I reviewed the 3 wildlife studies, that in my opinion, thoroughly address the issue. Design revisions, as suggested and endorsed by the wildlife consultants, have been made to the plans, to accommodate different sizes of wildlife that may traverse the site. The preservation of 11 acres of land into permanent open space is an added benefit mentioned by the wildlife consultants. It is also my understanding that Green & Company is considering increasing the open space to 16.3 acres, by adding all the land east of the electric easement into permanent open space.

In closing, after careful review of all the information submitted, in my opinion the submission package by TF Moran is complete, addresses staff and peer review comments and incorporates the multiple recommendations provided by the design teams' wildlife, stormwater and engineering consultants.

Having designed and permitted projects in Portsmouth since 1985, I am pleased to have had the opportunity to provide an independent review of the project and am confident this project will be an attractive and popular housing opportunity for Portsmouth residents.

Regards,



Gregg M. Mikolaities, PE
President, August Consulting, PLLC

Cc w/ Encl: Corey Colwell, TF Moran
Green & Company

The Village at Banfield Woods

Site Development Intensity Chart

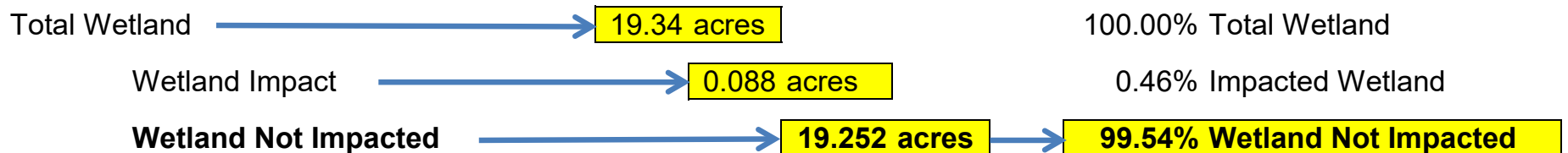
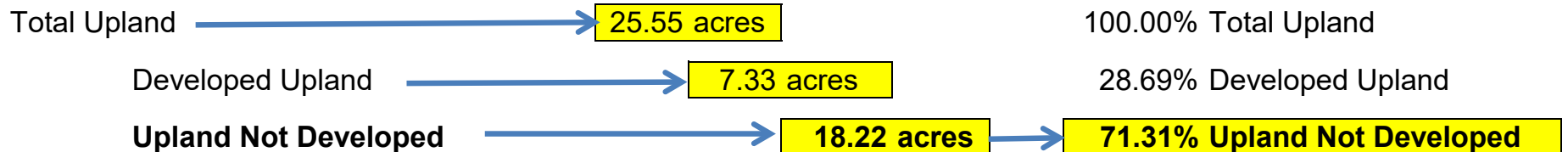
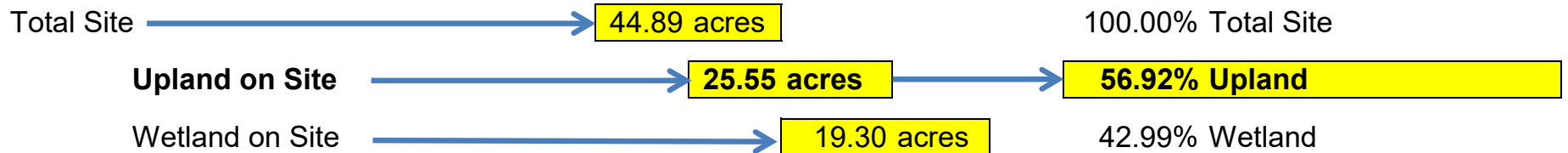
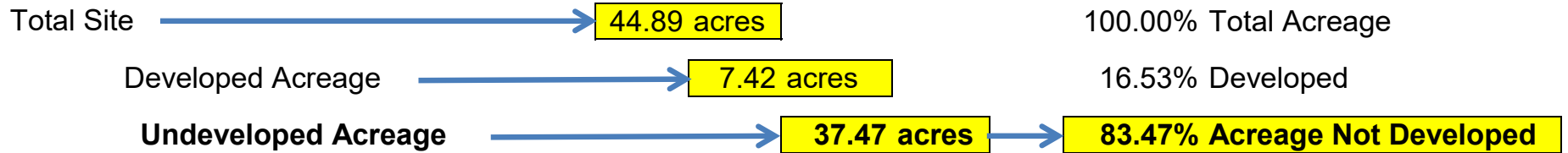

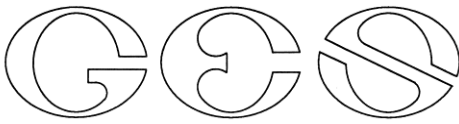

GOVE ENVIRONMENTAL SERVICES, INC.

THE VILLAGE AT BANFIELD WOODS
BANFIELD ROAD
PORTSMOUTH, NH

EXECUTIVE SUMMARY OF WETLANDS, SOILS, SEPTIC TEST PITS, SEPTIC PERC TESTS, WETLAND FUNCTIONS AND VALUES, DIRECT IMPACTS TO WETLANDS, AND IMPACTS TO WILDLIFE HABITAT

18 MAY, 2020

1- WETLANDS

- a. Wetlands were delineated in spring of 2019.
- b. Delineation was confirmed by Rockingham County Conservation District review.
- c. 18.87 acres of the 44.88 acre parcel are wetlands

2- SOILS

- a. Site-specific Soil Map was prepared for stormwater management analysis.
- b. The site is primarily loamy soils with some areas shallow to bedrock.
- c. Upland soils are suitable for development.

3- SEPTIC TEST PITS

- a. Test pits were dug in late summer and fall of 2019.
- b. Test pits were viewed by the Rockingham County Conservation District.
- c. The test pits identified areas that were suitable for septic systems.
- d. Septic systems will be over 100 feet away from wetland edges.
- e. Septic systems will have no hydrologic impact to wetlands.

4- SEPTIC PERC TESTS

- a. Perc tests were conducted in spring of 2020 in areas identified as being suitable for septic systems.
- b. Perc test found that all areas tested would meeting infiltration requirements.

5- WETLAND FUNCTIONS AND VALUES

- a. Wetland functions and values were analyzed using the US Army Corps of Engineers Highway Methodology Supplement.
- b. Wetlands are Freshwater Red Maple Forested Wetlands, which are the most common wetland found in New Hampshire.
- c. There are not Prime Wetlands designated on the site.
- d. There are no vernal pools on the site.
- e. Per Natural Heritage Inventory, there are no Threatened or Endangered species of plants or animals on the site.

8 Continental Dr Bldg 2 Unit H, Exeter, NH 03833-7526

Ph (603) 778 0644 / Fax (603) 778 0654

www.gesinc.biz

info@gesinc.biz

- f. Per the New Hampshire Wildlife Action Plan, the site is not the highest ranked habitat in the state, the site is not the highest ranked habitat in the region, rather, the site is supporting landscape for wildlife.
- 6- DIRECT IMPACT TO WETLANDS
- a. There is one wetland impact for a crossing to access developable uplands.
 - b. The crossing is at the narrowest point to impact the least amount of wetlands.
 - c. There is no other way to access the developable uplands.
 - d. The impact to wetlands is 3,838 square feet,
 - e. The New Hampshire Department of Environmental Services Wetlands Bureau classifies this level of impact as Minor.
 - f. State Dredge and Fill Permit to impact the wetland was issued of 18 May 2020 with permit number 2020-00344.
- 7- IMPACTS TO WILDLIFE HABITAT
- a. Uplands were found to be typical forested areas with sections of exposed ledge.
 - b. Uplands were found to have limited wildlife usage.
 - c. Low valleys, including wetlands, were found to have more wildlife use and movement.
 - d. Wildlife movement corridors were found both onsite and offsite.
 - e. The wetland impact access crossing will have minimal impact on the wildlife movement, both due to mitigating measures and due to other movement corridors that are preferred by the wildlife.
 - f. Mitigating measures were the addition of three ecopassages and the lowering/removal of retaining walls.
 - g. Movement corridors that are more preferred by wildlife lay to the north and west of the site.
 - h. The development envelope maintains the City of Portsmouth 100-foot forested buffer to wetlands.
 - i. The number of units inside the development envelope has no impact upon wildlife movement or use outside of the development envelope,
 - j. The number of housing units inside the development envelope is moot.
 - k. As long as the development envelop maintains the 100-foot forested buffer to wetlands, the number of houses inside the development envelope has no bearing of wildlife usage.

Complied by JP Gove.



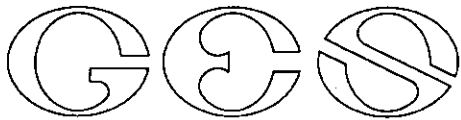

GOVE ENVIRONMENTAL SERVICES, INC.

TECHNICAL REPORT OF WETLAND FUNCTIONS AND VALUES

Date of Report: 6-27-2019

Amended 11-18- 2019

GES Project No.: 2017071

Project Location: BANFIELD ROAD, PORTSMOUTH

Prepared for: GREEN & COMPANY

Site Area Observed: TAX MAP 256, LOT 2

Site Conditions: FORESTED.

Wetlands Present: THREE WETLAND AREAS EVALUATED – A (east), A (west), B.

Seasonal Conditions: SITE WAS VISITED IN FALL OF 2018 AND SPRING 2019

Field Delineators: JP Gove CWS 051, CSS 004

Standards Utilized: THE HIGHWAY METHODOLOGY WORKBOOK SUPPLEMENT. WETLAND FUNCTIONS AND VALUES A DESCRIPTIVE APPROACH. US ARMY CORPS OF ENGINEERS, NEW ENGLAND DIVISION. 2016.

Compiled by: James P. Gove

A (east) : LARGEST WETLAND ONSITE. PRINCIPAL FUNCTIONS ARE FLOODFLOW ALTERATION, SEDIMENT/TOXICANT RETENTION, NUTRIENT REMOVAL, WILDLIFE HABITAT.

A (west): DRAINS INTO A(east). PRINCIPAL FUNCTIONS ARE SEDIMENT/TOXICANT RETENTION, NUTRIENT REMOVAL, WILDLIFE HABITAT.

B: SMALLEST WETLAND ONSITE, PRINCIPAL FUNCTION IS WILDLIFE HABITAT.

NO OBSERVATIONS ON SITE BY NHB19-1807

NO PRIME WETLANDS

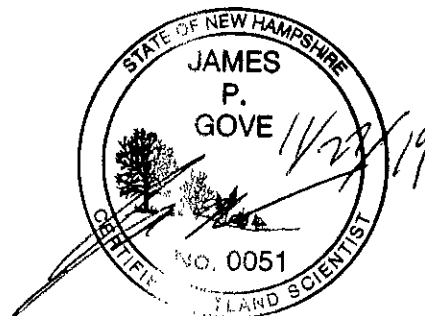

8 Continental Dr Bldg 2 Unit H, Exeter, NH 03833-7526
Ph (603) 778 0644 / Fax (603) 778 0654
info@gesinc.biz
www.gesinc.biz

This Page is intentionally Blank

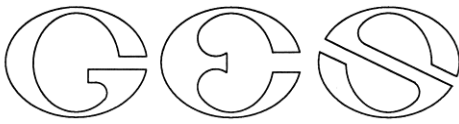

GOVE ENVIRONMENTAL SERVICES, INC.

WILDLIFE HABITAT ASSESSMENT
GREEN & COMPANY
BANFIELD ROAD, PORTSMOUTH
11/29/2019
Compiled by Luke Hurley

The site consists of approximately 45 acres of woodland and wetland areas. The site also has an existing maintained powerline easement bisecting the property into two pieces. The site is bordered by Banfield Road to the south and forested, unfragmented land to the north, east, and west. The site is somewhat of an island between Rote 95 to the north, Middle and Peverly Hill Roads to the east and Ocean Road to the west.

Upland Areas

Field analysis of this community type reveals a dominance of mixed-age red maple (*Acer rubrum*), sugar maple (*Acer sacharum*), yellow birch (*Betula allegheniensis*), white pine (*Pinus strobus*), and American beech (*Fagus grandifolia*), along with red oak (*Quercus rubra*) and eastern white pine (*Tsuga canadensis*) comprising the overstory of this natural community. Species in the canopy range in size from pole-size to mature trees. Small inclusions within this site are dominated by white pine in the tree layer

The shrub layer includes low bush blueberry (*Vaccinium angustifolium*) as well as regenerating canopy species. Analysis of herbaceous species reveals the presence of wintergreen (*Gaultheria procumbens*), partridgeberry (*Mitchella repens*), clubmoss (*Lycopodium spp.*), and bracken fern (*Pteridium aquilinum*), as well as several bryophytes and grasses.

There is very little variation in this natural community type throughout the wooded area of the parcel. This is similarly found in the other surrounding woodlands.

This natural community is common in southern New Hampshire.

Wetland Areas

There are two wetland areas on the site. Wetland A (both A-east and A-west) is located on the south and eastern portion of the lot. This wetland continues north to the powerlines. It is a combination of forested (PFO1E) and scrub shrub (PSS1E) vegetation. The wetland is dominated by red maple, Eastern Hemlock, American elm, and yellow birch in the tree layer, highbush blueberry, winterberry, sweet pepper bush, gray dogwood, and speckled alder in the shrub layer and cinnamon, sensitive, and royal fern, swamp dewberry, *Sphagnum* moss, and a variety of sedges and rushes in the herbaceous layer.

8 Continental Dr Unit H, Exeter, NH 03833-7507
Ph (603) 778 0644 / Fax (603) 778 0654
www.gesinc.biz
info@gesinc.biz

On April 25, 2019, GES conducted a site walk to view the two on site potential vernal pool areas that lay west of the powerline. The two areas did not have any vernal pool activity and did not appear to have enough water to support a vernal pool hydroperiod. No off-site areas were checked for vernal pool activity.

The smaller wetland on site, noted on the plans as “B”, is a forested wetland shrub wetland (PFOE1) with highbush blueberry, winterberry, gray dogwood, and speckled alder in the shrub layer and cinnamon, sensitive, and royal fern, swamp dewberry, and *Sphagnum* moss in the herbaceous layer. The tree layer is primarily red maple with a few white pines.

No prime wetlands are found on site. Results from the New Hampshire Natural Heritage Bureau indicates no known occurrences of rare, threatened, or endangered species, or natural communities on site. The results, which are attached, show two natural communities and two plant species in the large wetland area to the west, but not directly on site.

As part of the assessment several hours were spent on site to observe signs and calls for wildlife that might be present on site or that had recently used the site for travel. Those noted on site are listed below. Overall, the site had little notable, direct observation of wildlife usage. The survey was performed on July 15 and temperatures were high. While the primary wildlife survey was conducted on this day multiple visits to the site have been conducted, through wetland delineations, vernal pool surveys, soil mapping and test pits. The habitat assessment for direct wildlife usage was not based on one single day of field work. Though the survey started in the morning, the temperature rose quickly, and this often results in wildlife seeking shelter from the mid-day heat and therefore they lessen their activity. Noted species are common throughout this area of the state. There was noted deer activity sporadically throughout the site, but no main corridors were observed. As the site is relatively flat with gentle slopes, large wildlife such as deer were not confined to ridges or lowlands for travel. Older evidence of presence was observed, such as scat was dried out and digging areas also appeared to be older.

Several areas of large rock out crops were present on site. However, no direct use by wildlife was observed. As prominent ledge knobs, they lacked significant areas of open “cave-like” places for larger mammals such as, fox, coyote or porcupine. These rock outcrops can often be a place for small mammals (such as chipmunks, mice, and squirrels) to den and retreat from predators. The stone walls lining the parcel are also a potential source of habitat for these mentioned species.

We have projected possible wildlife corridors on site. A map indicating these areas is attached. It will depict predicted corridors for small mammals, large mammals, as well as amphibious and reptilian species.

Observed Species:

Birds

Black-capped chickadee

Downy woodpecker

Tufted titmouse



Red breasted nuthatch
Turkey

Mammal
White-tailed deer (old)

Potential Wildlife Usage

The potential for various species of wildlife to occur onsite is subjective and is not always the best way to assess the value of a site. A parcel like this one, within a larger undeveloped block of land, has a high potential for use by wildlife, based on the cover types, wetland areas on and adjacent to the site, undeveloped corridors to travel to and from areas of denning and foraging and the presence of food sources from those of primary producers through plants, to primary and secondary consumers of insects and small mammals, reptiles and amphibians and deer, to tertiary and quaternary consumers through various weasel, canine and birds of prey species.

The deeper areas of the forest have the potential for less common avian species, of thrush, vireos and warblers, which are considered neo-tropical migrants and use this region of the state and country for spring and summer nesting and fly south for the winter. The wetland areas on the site are used in the same manner, as many of the shrub species within the wetlands are flower and subsequently fruit and seed bearing, that attract pollinating insects as food sources, and fruits/seeds to be eaten as many species of finches, warblers, vireos, thrushes, grackles are passing through during migration. Common year-round species, like those noted above, as well as robins, goldfinches, cardinals, many species of small to larger woodpeckers, blue jays, grey catbird, mockingbird, as well as winter species of finches and juncos summering in the north and winter in this area. These areas can also be used by hawk and owl species with adequate areas for nesting and hunting. The presence of significant hard mast trees and numerous acorn production could also be used by turkey.

The site in general has the potential for use by numerous mammal species from mice, moles and shrews, to skunks, opossum, racoon, to fox and coyote and deer.

With this, the potential for a site to have a significant and diverse wildlife population, does not always mean that it will. Much like the ideal habitat for a vernal pool, may not have any breeding activity, though it seems like it should. While the site is located within a larger overall area of over 950 acres, travel to and from the parcel is limited to the area on the south west side. Heavy development to the north and east, with I-95 to the north west significantly limit travel in and out of this parcel. The area to the southwest has the crossing limitation of Ocean Road, but in the greater geographic area, is the least obstructed area for wildlife movement towards and away from the site.

Impacts to wildlife is always a threat with any development and this project is no different. The greatest issue with this development is the bisecting of the site with the proposed road, limiting any existing and potential wildlife travel. While the site itself is approximately 45 acers, only the area to the west of the power lines is slated for development. That still leaves over 900 acres of undeveloped land in the area and approximately half of the 45-acre site intact. The development



has taken into consideration the connectivity of the site from the east to the west and has incorporated an open box culvert, outside of the wetlands, to facilitate the movement of small species that may not be as apt to go around and over the proposed road. Ample area will still be available to the north of the proposed development for wildlife to move from the west to the east. Wetland impacts are a small fraction of the overall wetland area on site and would not be expected to have impacts on those wetland dependent species, with the maintaining of the 100-foot buffer.



Photolog





1. Representative view of the central upland area on site. Note stonewall in background.



2. Additional view of upland with possible cavity nesting tree for small birds or rodents.



3. Large rock outcrop on site. One of the many located throughout the property.



4. Cavity nesting tree for small rodents or birds.



5. Older deer droppings.



6. Wood frog



7. Mushroom with chewing on side. Most likely from a mouse or chipmunk.



8. Possible small rodent burrow.



9. Additional photo of older deer droppings

Potential Wildlife Movement

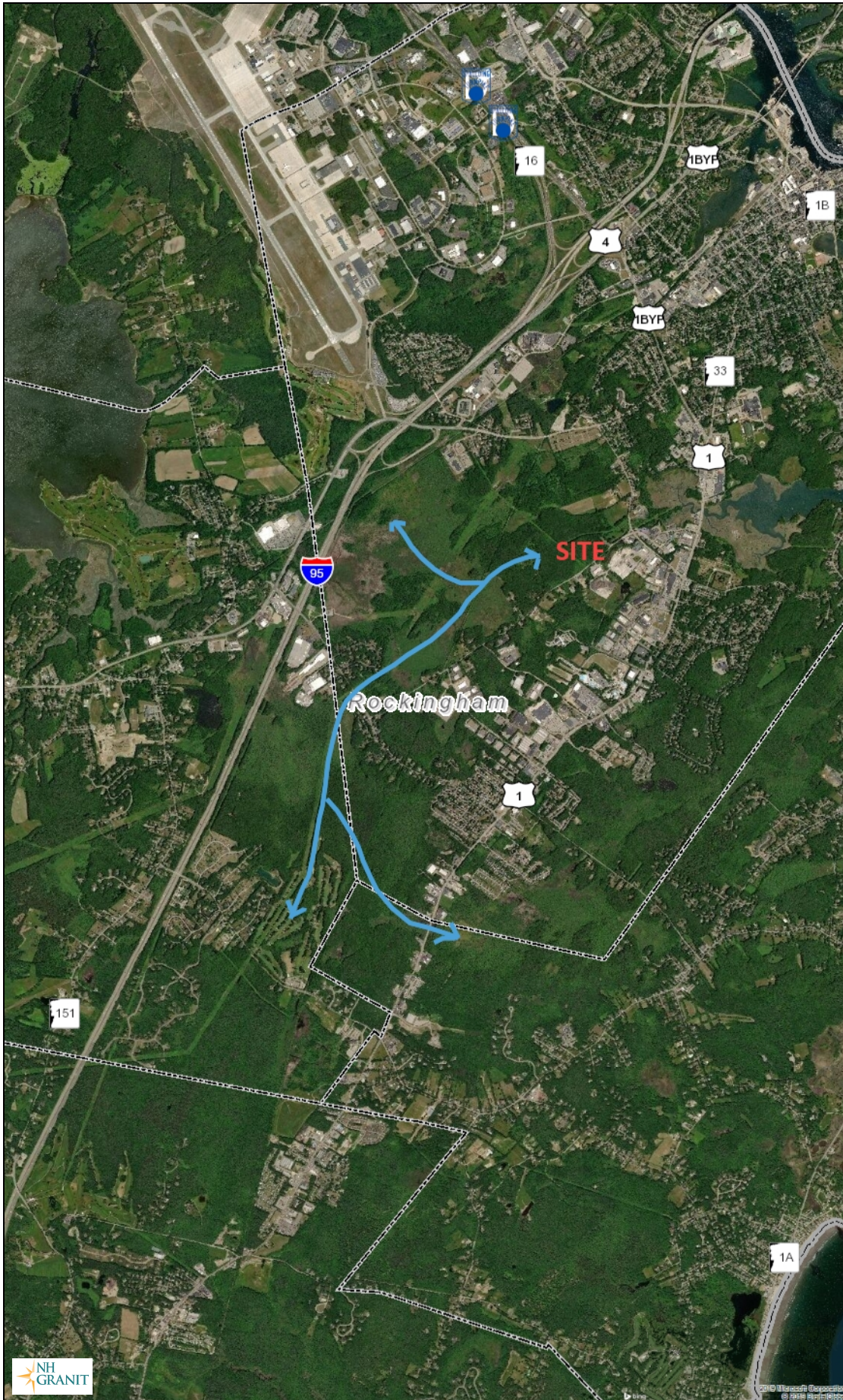

Legend

- State
- County
- City/Town

Map Scale

1: 51,953

© NH GRANIT, www.granit.unh.edu

Map Generated: 11/27/2019



Notes

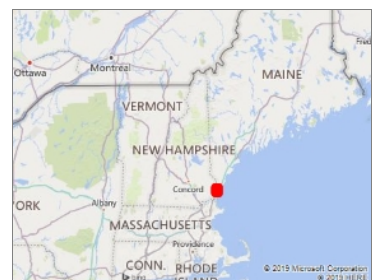

This Page is intentionally Blank

Wetland Function-Value Evaluation Form

Total area of wetland 17 AC Human made? No Is wetland part of a wildlife corridor? Yes or a "habitat island"? No
 Adjacent land use Developed and Forest Distance to nearest roadway or other development Adjacent
 Dominant wetland systems present PFO1C & PSS1C Contiguous undeveloped buffer zone present Yes
 Is the wetland a separate hydraulic system? No If not, where does the wetland lie in the drainage basin? Middle
 How many tributaries contribute to the wetland? 2 Wildlife & vegetation diversity/abundance (see attached list)

Wetland I.D. BaA (east)

Latitude _____ Longitude _____
 Prepared by: JPG Date 6-27-19

Wetland Impact: _____ Area N/A
 Type None

Evaluation based on:
 Office X Field X
 Corps manual wetland delineation completed? Y X N

Function/Value	Suitability Y / N	Rationale (Reference #)*	Principal Function(s)/Value(s)	Comments
Groundwater Recharge/Discharge	Y	6, 7, 13	N	Marine Silts - Discharge area
Floodflow Alteration	Y	1, 3, 5, 6, 7, 8, 9, 13, 18	Y	Large, flat, constricted outlet
Fish and Shellfish Habitat	N	1	N	Intermittent streams only
Sediment/Toxicant Retention	Y	1, 2, 3, 4, 5, 7	Y	Runoff from Banfield Road
Nutrient Removal	Y	1, 3, 4, 6, 7, 8, 9, 12	Y	Runoff from Banfield Road
Production Export	Y	1, 4, 5, 7	N	Not a high degree of diversity or open water
Sediment/Shoreline Stabilization	N		N	No shoreline present
Wildlife Habitat	Y	1, 5, 6, 7, 8, 10, 13	Y	Not a high degree if diversity but is a wildlife corridor
Recreation	N	3	N	Private land, limited access
Educational/Scientific Value	N	2	N	Private land, limited access
Uniqueness/Heritage	N		N	No NHB hits on site
Visual Quality/Aesthetics	N		N	No viewing points, no open water
Endangered Species Habitat	N		N	No NHB hits on site
Other	Y	Vernal Pools	---	4 vernal pools present

Notes: _____

* Refer to backup list of numbered considerations.

Wetland Function-Value Evaluation Form

Total area of wetland 4 AC Human made? No Is wetland part of a wildlife corridor? Yes or a "habitat island"? No
 Adjacent land use Developed and Forest Distance to nearest roadway or other development Adjacent
 Dominant wetland systems present PFO1C Contiguous undeveloped buffer zone present Yes
 Is the wetland a separate hydraulic system? No If not, where does the wetland lie in the drainage basin? Upper to Middle
 How many tributaries contribute to the wetland? 1 Wildlife & vegetation diversity/abundance (see attached list)

Wetland I.D. A (west)
 Latitude _____ Longitude _____
 Prepared by: JPG Date 6-27-19
 Wetland Impact: Type Crossing Area <3000 SF
 Evaluation based on: Office X Field X
 Corps manual wetland delineation completed? Y X N

Function/Value	Suitability Y / N	Rationale (Reference #)*	Principal Function(s)/Value(s)	Comments
Groundwater Recharge/Discharge	Y	6,7,13	N	Marine Silts - Discharge area
Floodflow Alteration	Y	2,5,6,9	N	Sloping, narrow, little ponding
Fish and Shellfish Habitat	N	1	N	Intermittent stream
Sediment/Toxicant Retention	Y	1,2,4,7,8,9	Y	Runoff from Banfield Road
Nutrient Removal	Y	1,3,4,6,7,8,9,12	Y	Runoff from Banfield Road
Production Export	Y	1,4,5	N	Not a high degree of diversity or open water
Sediment/Shoreline Stabilization	N		N	No shoreline present
Wildlife Habitat	Y	1,4,5,7,8,16,18	Y	Not a high degree if diversity but is a wildlife corridor
Recreation	N	3	N	Private land, limited access
Educational/Scientific Value	N	2	N	Private land, limited access
Uniqueness/Heritage	N		N	No NHB hits on site
Visual Quality/Aesthetics	N		N	No viewing points, no open water
ES Endangered Species Habitat	N		N	No NHB hits on site
Other	N	Vernal Pools	---	None present

Notes: * Refer to backup list of numbered considerations.

Wetland Function-Value Evaluation Form

Total area of wetland 1/2 AC Human made? No Is wetland part of a wildlife corridor? No or a "habitat island"? No

Adjacent land use Forest Distance to nearest roadway or other development 500 ft +













Dominant wetland systems present PFO1C Contiguous undeveloped buffer zone present Yes

Is the wetland a separate hydraulic system? Yes If not, where does the wetland lie in the drainage basin? _____

How many tributaries contribute to the wetland? 0 Wildlife & vegetation diversity/abundance (see attached list)

Wetland I.D. B
 Latitude _____ Longitude _____
 Prepared by: JPG Date 6-27-19
 Wetland Impact: _____ Area N/A

Evaluation based on:
 Office Field
 Corps manual wetland delineation completed? Y N

Function/Value	Suitability Y / N	Rationale (Reference #)*	Principal Function(s)/Value(s)	Comments
 Groundwater Recharge/Discharge	N		N	Isolated, seasonal runoff hydrology
 Floodflow Alteration	Y	3.5.,9	N	Small, isolated, limited storage
 Fish and Shellfish Habitat	N	1	N	No stream
 Sediment/Toxicant Retention	N	4	N	No sources
 Nutrient Removal	Y	3,7,8,9	N	Small and isolated
 Production Export	N	1	N	Small and isolated
 Sediment/Shoreline Stabilization	N		N	No shoreline present
 Wildlife Habitat	Y	1,3,4, 5,7,8,18	Y	Limited to birds and small mammals
 Recreation	N	3	N	Private land, limited access
 Educational/Scientific Value	N	2	N	Private land, limited access
 Uniqueness/Heritage	N		N	No NHB hits on site
 Visual Quality/Aesthetics	N		N	No viewing points, no open water
 ES Endangered Species Habitat	N		N	No NHB hits on site
Other	N	Vernal Pools	---	None present, low water levels

Notes: _____ * Refer to backup list of numbered considerations.

This Page is intentionally Blank

CONFIDENTIAL – NH Dept. of Environmental Services review

Memo



NH NATURAL HERITAGE BUREAU
NHB DATACHECK RESULTS LETTER

To: Luke Hurley, Gove Environmental Services, Inc.
8 Continental Drive
Exeter, NH 03833

From: Amy Lamb, NH Natural Heritage Bureau
Date: 6/17/2019 (valid for one year from this date)

Re: Review by NH Natural Heritage Bureau

NHB File ID: NHB19-1807

Town: Portsmouth

Location: Tax Maps: 256-2

Description: This project is planned to be a 22 unit open space residential facility.

As requested, I have searched our database for records of rare species and exemplary natural communities, with the following results.

Comments: Please send NHB a plan set showing proposed wetland impacts, stormwater structures, building and parking infrastructure, and “open space” areas.

Natural Community	State ¹	Federal	Notes
Drainage marsh - shrub swamp system	--	--	Threats to this community include changes to the wetland’s hydrology either through damming or increasing drainage. Significant increases in nutrients and pollutants from stormwater runoff could also have a deleterious effect on the wetland.
Red maple - sensitive fern swamp	--	--	These swamps are influenced by groundwater seepage and springs which moderate water fluctuations and maintain conditions favorable for the accumulation of organic matter. The primary threats are changes to the hydrology of the wetland complex, particularly raising or lowering the water levels, and increased nutrient and pollutant input carried in by stormwater runoff.
Plant species	State ¹	Federal	Notes
great bur-reed (<i>Sparganium eurycarpum</i>)	T	--	Threats to aquatic species include changes in water quality, e.g., due to pollution and stormwater runoff, and significant changes in water level.
tufted yellow-loosestrife (<i>Lysimachia thyrsoiflora</i>)*	T	--	As a resident of peatlands, this species is susceptible to any changes to the wetland’s hydrology (especially that which causes pooling), increased nutrient input from stormwater runoff, and sedimentation from nearby disturbances.

¹Codes: "E" = Endangered, "T" = Threatened, "SC" = Special Concern, "--" = an exemplary natural community, or a rare species tracked by NH Natural Heritage that has not yet been added to the official state list. An asterisk (*) indicates that the most recent report for that occurrence was more than 20 years ago.

A negative result (no record in our database) does not mean that a sensitive species is not present. Our data can only tell you of known occurrences, based on information gathered by qualified biologists and reported to our office. However, many areas have never been surveyed, or have only been surveyed for certain species. An on-site survey would provide better information on what species and communities are indeed present.

CONFIDENTIAL – NH Dept. of Environmental Services review

NHB19-1807

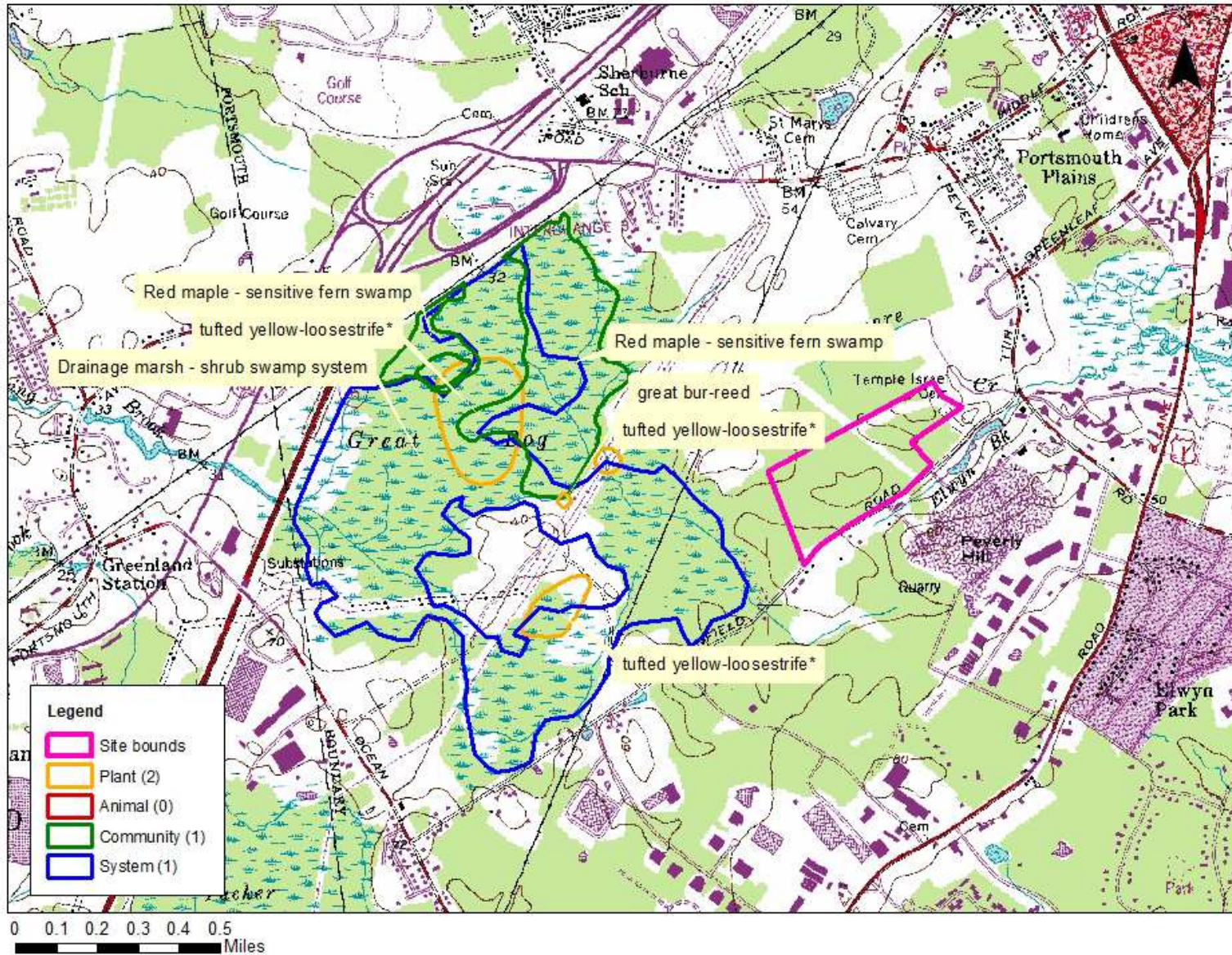

New Hampshire Natural Heritage Bureau - System Record

Drainage marsh - shrub swamp system

Legal Status

Federal: Not listed
State: Not listed

Conservation Status

Global: Not ranked (need more information)
State: Demonstrably widespread, abundant, and secure

Description at this Location

Conservation Rank: Good quality, condition and landscape context ('B' on a scale of A-D).
Comments on Rank: Despite the compromised condition and context ranks, this is an exemplary system because it is a very large, diverse emergent marsh system with coastal plain affinities.

Detailed Description: 2009: Emergent marsh, seepage marsh, meadow marsh, and shrub thicket communities cover most of Great Bog, a broad, coastal plain basin with very poorly drained marine sediment soil and moderate to deep mucky peat soils (over marine sediments). Sedges and/or cattails dominate the marsh communities, which occupy most of the treeless or sparsely wooded areas of the larger wetland. Shrub thickets are also common but occupy a minority of the system. These various communities cover large areas individually, but also occur together in more complex, fine-scaled mosaics in places. Herbaceous seepage marsh and cattail marsh are apparently the most extensive communities. Herbaceous seepage marshes, described from earlier visits and dominated by *Carex lacustris* (lake sedge), occupy large areas in the western part of Great Bog on Maybid silt loam soil, and possibly occur elsewhere. *Typha latifolia* (common cattail) dominate the cattail marshes in most areas on deeper mucks, but some are dominated by *Typha angustifolia* (narrow-leaved cattail), including the south-central portion of the wetland (south of the upland island in the middle of the wetland). *Carex stricta* (tussock sedge) dominates areas of **tall graminoid meadow marsh** and **mixed tall graminoid - scrub-shrub marsh**, along with various other sedges, grasses, forbs, and medium-height to tall shrubs. Shrub thickets include **alder - dogwood - arrowwood alluvial thicket** and **highbush blueberry - winterberry shrub thicket**. *Ilex verticillata* (winterberry), *Vaccinium corymbosum* (highbush blueberry), *Clethra alnifolia* (sweet pepperbush), *Alnus incana* ssp. *rugosa* (speckled alder) are abundant. *Lyonia ligustrina* (male berry) and *Toxicodendron vernix* (poison sumac) are occasional. Small to large colonies of *Phragmites australis* (common reed) occupy portions of the wetland, including the eastern lobe adjacent to Banefield Rd., which was sprayed with herbicide in September 2009. The marsh and shrub communities extend to the upland margin around most of the periphery, but transition to various swamp communities along the northeast side and discontinuously elsewhere.

General Area: 2009: Great Bog is set in low-relief coastal terrain, surrounded by both dry and mesic Appalachian oak - hickory forests, as well as swamps along subtle drainages that feed into the wetland. A complex mosaic of parent materials in the surrounding landscape include shallow ablation till, outwash sediments, and silt and clay soils of marine origin. Upland forests and swamps occur on the largely undeveloped northeast side. Roads, parking lots, and other residential and industrial development are common close to the wetland in other border areas. Invasive exotic shrubs are common in the upland areas immediately adjacent to the wetland, including vast forest thickets of *Frangula alnus* (alder-buckthorn) on the upland island in the central part of the wetland, through which the powerline corridor runs. These are perhaps the most extensive, old, and impenetrable thickets of alder-buckthorn this surveyor has seen, covering dozens of acres. Eighty percent or more cover of alder-buckthorn was common, with very little or no other vegetation in the understory. Other portions of this upland island were more open old fields with remnant orchard trees. Numerous other invasives are present, including *Rosa multiflora* (multiflora rose), *Berberis thunbergii* (Japanese barberry), and *Celastrus orbiculatus* (Asian bittersweet).

General Comments:
Management
Comments:

Location

Survey Site Name: Great Bog
Managed By: Portsmouth I, City of

County: Rockingham
Town(s): Portsmouth
Size: 349.3 acres Elevation:

Precision: Within (but not necessarily restricted to) the area indicated on the map.

Directions: 2009: Accessed site from railroad tracks that cross Banefield Rd.

Dates documented

First reported: 2009-09-29 Last reported: 2009-09-29

New Hampshire Natural Heritage Bureau - Community Record

Red maple - sensitive fern swamp

Legal Status

Federal: Not listed
State: Not listed

Conservation Status

Global: Not ranked (need more information)
State: Rare or uncommon

Description at this Location

Conservation Rank: Good quality, condition and landscape context ('B' on a scale of A-D).

Comments on Rank: This is a fairly mature and very large example in a compromised landscape context. This part of Great Bog is less influenced by hydrologic alterations than portions nearer the outlet to the west.

Detailed Description: 2002: Two seepage swamp associations were observed at the north end of the seepage swamp system. Area 1 occurs further east (ie along border of development to the east) and has a denser *Acer rubrum* (red maple) cover (60-70%) and a sparse shrub layer. It is dominated by *Carex stricta* (tussock sedge; 35%), *Calamagrostis canadensis* (blue-joint; 15-20%), and *Onoclea sensibilis* (sensitive fern), with lesser quantities of *Carex lacustris* (lake sedge) and *Toxicodendron radicans* (climbing poison ivy). Area 2 is a classic red maple/lake sedge seepage swamp, with all the species of Area 1 present in lower abundance, less dense red maple (40%), a dominant layer of *Carex lacustris* (lake sedge; 60%) and sensitive fern (5%), and a denser shrub layer consisting mostly of *Vaccinium corymbosum* (highbush blueberry; 30%) and *Ilex verticillata* (winterberry; 5%). *Ulmus americana* (American elm) is occasional in the subcanopy. 1989: *Acer rubrum* (red maple) dominates. Understory dominants include *Carex stricta* (tussock sedge), *Alnus serrulata* (smooth alder), *Onoclea sensibilis* (sensitive fern), *Symplocarpus foetidus* (skunk cabbage). *Lysimachia thyrsoiflora* (tufted loosestrife) also occurs here.

General Area: 2002: The seepage swamp is the dominant community in eastern portion of Great Bog, and bounded to the west by the large seepage marsh, to the north by railroad tracks, to the south by powerlines and upland. While surrounded by development, Great Bog is so large that it is actually one of the largest and least developed tracts of land in Portsmouth.

General Comments: 1989: Further field work needed.

Management

Comments:

Location

Survey Site Name: Great Bog

Managed By: Griffin

County: Rockingham

Town(s): Portsmouth

Size: 100.0 acres

Elevation:

Precision: Within (but not necessarily restricted to) the area indicated on the map.

Directions: Great Bog. North and west of powerline right-of-way. Best approach to portion of site visited in 2002 (without pulling over on I-95) is from north via the railroad tracks just south of crossing of Rte. 33 and I-95. Park in vicinity of Rte. 33 crossing of railroad tracks, at industrial complex on Griffen Rd to south of Rte. 33 (closest but dense shrub border along RR track) or at RR bridge by Greenland and Borthwick Streets just north of Rte. 33 (easiest). Proceed southwest on RR tracks. The seepage swamp is located to the south just past the industrial complex (0.25 miles from Rte. 33); the seepage marsh is found further along past the seepage swamp (open area with few trees ca. 0.45 miles from Rte. 33); and the swamp white oak swamp is found where trees pick up again south of the RR tracks closer to the highway crossing (0.7 miles from Rte. 33).

Dates documented

CONFIDENTIAL – NH Dept. of Environmental Services review

First reported: 1989-05-30

Last reported: 2002-09-27

New Hampshire Natural Heritage Bureau - Plant Record

great bur-reed (*Sparganium eurycarpum*)**Legal Status**

Federal: Not listed
 State: Listed Threatened

Conservation Status

Global: Demonstrably widespread, abundant, and secure
 State: Imperiled due to rarity or vulnerability

Description at this Location

Conservation Rank: Poor quality, condition and/or landscape context ('D' on a scale of A-D).
 Comments on Rank: Small population size.

Detailed Description: 2010: At least 2 stems, with fruit/flowers.

General Area: 2010: Edge of a partially shaded (red maple?) swamp. Skunk cabbage (*Symplocarpus foetidus*) present along with some buttercup or crowfoot (*Ranunculus* sp.) species and a sedge (*Carex* sp.) with large fruits (0.5 inches diameter, 2 inches long).

General Comments:
 Management
 Comments:

Location

Survey Site Name: Great Bog
 Managed By: Portsmouth I, City of

County: Rockingham

Town(s): Portsmouth

Size: .4 acres

Elevation:

Precision: Within (but not necessarily restricted to) the area indicated on the map.

Directions: 2010: From Rte. 33 in Greenland, go SE on Ocean Road crossing I-95. The next left is Buckminster Way which has a short spur driveway that is blocked off with posts and a chain. Park here; a trail leads NE through woods to a large open upland area crisscrossed by power lines. The spot in question is right near the edge of a wetland and is fairly easy to access from the upland area (43.04553N, 70.80095W). Note that this spot may be difficult to access if water levels are high.

Dates documented

First reported: 2010-06-21

Last reported: 2010-06-21

New Hampshire Natural Heritage Bureau - Plant Record

tufted yellow-loosestrife (*Lysimachia thyrsiflora*)**Legal Status**

Federal: Not listed
 State: Listed Threatened

Conservation Status

Global: Demonstrably widespread, abundant, and secure
 State: Imperiled due to rarity or vulnerability

Description at this Location

Conservation Rank: Historical records only - current condition unknown.
 Comments on Rank: New Hampshire's best population.

Detailed Description: 2010: Searched for but not found.
2004: Searched for but not found.
2002:
 Searched for but not found.
1989: Thousands of budding plants.
1983: 2 small
 populations, 11-50 individuals. Specimen collected.

General Area: 1989: SNE seepage marsh. Also in red maple swamp. With *Carex rostrata* (beaked sedge),
Acer rubrum (red maple), *Typha latifolia* (common cat-tail), and *Osmunda cinnamomea*
 (cinnamon fern). 1983: Where a powerline crosses a branch of a brook.

General Comments: 1989: Occurs in 2 areas of seepage marsh.

Management 2004: Lots of exotic species present.

Comments:

Location

Survey Site Name: Great Bog
 Managed By: Griffin

County: Rockingham

Town(s): Portsmouth

Size: 45.8 acres

Elevation:

Precision: Within (but not necessarily restricted to) the area indicated on the map.

Directions: Great Bog. South and east of crook in powerline right-of-way.
1989: Areas 2 and 3: Park at
 railroad crossing of Banfield Road. Access via dirt road heading NW from Banfield Road about 0.2
 miles north of the railroad (much of this road was flooded to 18 inches).
1983: Area 1: Great
 Bog. At crossing of branch of Pickering Brook and the electric line (brook crossing of utility line and
 service lane).

Dates documented

First reported: 1983-06-16

Last reported: 1989-05-30

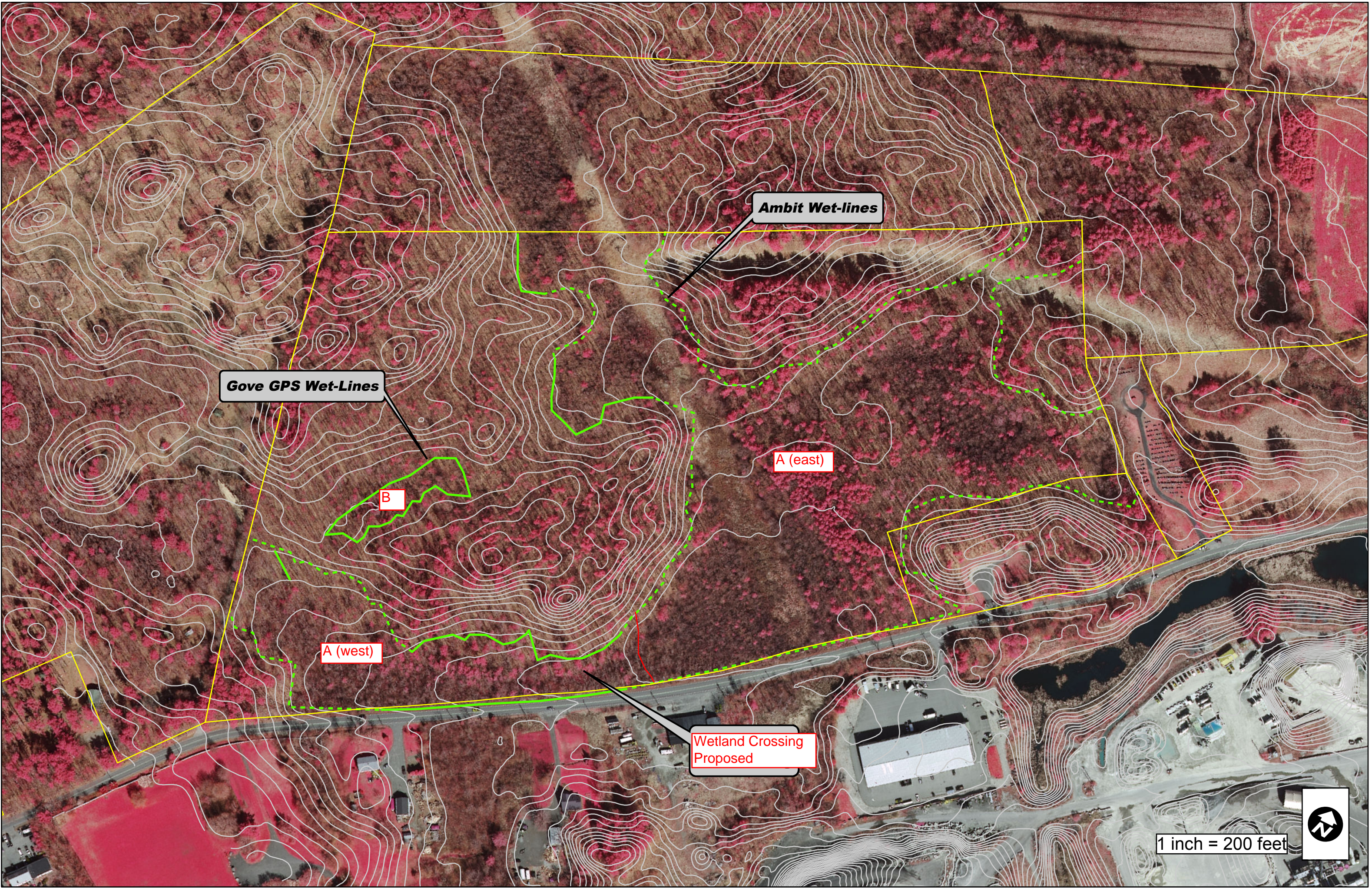

Ambit Wet-lines

Gove GPS Wet-Lines

A (east)

B

A (west)

Wetland Crossing Proposed

1 inch = 200 feet



This Page is intentionally Blank

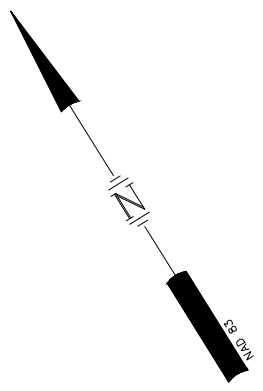

-  Potential Vernal Pools
-  Predicted Large Mammal corridor
-  Predicted Small Mammal Corridor
-  Predicted Amphibian & Reptile Corridor



- NOTES:
- THE PURPOSE OF THIS PLAN IS TO SHOW THE CITY OF PORTSMOUTH WETLAND IMPACTS AND WETLAND BUFFER IMPACTS ASSOCIATED WITH THE CONDOMINIUM DEVELOPMENT OF TAX MAP 256 LOT 2.
 - FIELD SURVEY WAS COMPLETED BY TCE AND EJS IN MAY & JUNE 2019 USING A TOPCON DS103 AND A TOPCON FC-5000 DATA COLLECTOR.
 - THE PURPOSE OF THE BUILDING FOOTPRINTS SHOWN ON THE PLAN ARE FOR ILLUSTRATIVE PURPOSES ONLY. FOOTPRINTS MAY CHANGE DURING CONSTRUCTION, BUT WILL REMAIN WITHIN REQUIRED SETBACKS. INDIVIDUAL GRADING PLAN ARE REQUIRED FOR EACH AREA OF HOMES TO BE DEVELOPED (PRIOR TO BUILDING PERMIT).
 - DENSITY CALCULATIONS:
 TOTAL LOT AREA: 44.88 ACRES
 WETLAND AREA: 18.97 ACRES
 STEEP SLOPES OVER 15%: 2.20 ACRES
 TOTAL DEVELOPABLE AREA: 23.71 ACRES (REMAINING LAND IS WETLANDS AND STEEP SLOPES OVER 15%)
 MAXIMUM UNITS FOR DEVELOPMENT: 23 SINGLE FAMILY HOUSES
 PROPOSED UNITS FOR OPEN SPACE PLANNED UNIT DEVELOPMENT: 22 THREE (3) BEDROOM UNITS
 - PARKING CALCULATIONS:
 REQUIRED: 1.3 SPACES/UNIT PLUS ONE (1) VISITOR SPACE FOR EVERY 5 DWELLING UNITS.
 TOTAL REQUIRED = 33 SPACES

 PROPOSED: 88 SPACES (2 GARAGED SPACES PER UNIT, PLUS 44 SPACES ON PRIVATE DRIVEWAYS)
 - WETLANDS DELINEATION WAS COMPLETED BY COVE ENVIRONMENTAL SERVICES IN MAY 2019 AND FIELD LOCATED BY MSC A DIVISION OF TFMORAN, INC.
 - STEEP SLOPE AREAS ARE APPROXIMATE. TOWN REGULATIONS DEFINE SLOPES OF 15% AND GREATER TO BE NON-BUILDABLE.
 - EXAMINATION OF THE FLOOD INSURANCE RATE MAP FOR THE TOWN OF PORTSMOUTH, NEW HAMPSHIRE, ROCKINGHAM COUNTY, COMMUNITY PANEL NUMBER 0270, EFFECTIVE DATE: MAY 17, 2005, INDICATES THAT THE SUBJECT PARCEL IS NOT LOCATED WITHIN A FLOOD HAZARD AREA.
 - WETLAND IMPACTS WILL REQUIRE AN APPLICATION TO NHDES WETLANDS BUREAU AND A CONDITIONAL USE PERMIT FROM THE CITY OF PORTSMOUTH. OBTAINING THESE PERMITS WILL DEPEND ON THE WETLAND FUNCTION AND VALUES, AND SENSITIVITY OF THE PROJECT.
 - TESTING FOR SUITABLE AREAS FOR SEPTIC SYSTEMS AND WELLS WILL BE REQUIRED TO CONFIRM THAT SERVICES CAN BE PROVIDED ON SITE, AND/OR AVAILABLE MUNICIPAL SEWER AND WATER CAPACITY WILL NEED TO BE VERIFIED DURING THE DESIGN PROCESS.
 - SITE DEVELOPMENT MAY REQUIRE RETAINING WALLS FOR GRADE CHANGES.
 - PRIOR TO ANY EXCAVATION ON SITE THE CONTRACTOR SHALL CONTACT DIG SAFE AT 811.

WETLAND IMPACTS TABLE					
WETLAND	WETLAND AREA	TEMPORARY WETLAND IMPACT	PERMANENT WETLAND IMPACT	TEMPORARY BUFFER IMPACT	PERMANENT BUFFER IMPACT
A	815,360 S.F.	1,135 S.F.	2,693 S.F.	720 S.F.	5,858 S.F.
B	26,935 S.F.	0 S.F.	0 S.F.	386 S.F.	297 S.F.
TOTALS	842,295 S.F.	3,828 S.F.		7,261 S.F.	

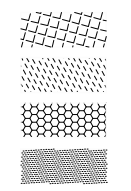

TAX MAP 256 LOT 2
WETLAND IMPACT PLAN - ALTERNATE ALIGNMENT
THE VILLAGE AT BANFIELD WOODS
PORTSMOUTH, NH
 OWNED BY
WALTER D HETT TRUST
 PREPARED FOR
GREEN & COMPANY REAL ESTATE
1"=160' (11"X17")
SCALE: 1"=80' (22"X34") **SEPTEMBER 25, 2019**

Copyright 2019 © Thomas F. Moran, Inc.
 48 Constitution Drive, Bedford, N.H. 03110
 All rights reserved. These plans and materials may not be copied, duplicated, replicated or otherwise reproduced in any form whatsoever without the prior written permission of Thomas F. Moran, Inc.
 This plan is not effective unless signed by a duly authorized officer of Thomas F. Moran, Inc.

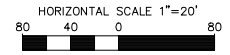

REV.	DATE	DESCRIPTION	DR	CK
1	12/03/19	Revised Alignment Per Regulatory Comments		

	Civil Engineers Structural Engineers Traffic Engineers Land Surveyors Landscape Architects Scientists	48 Constitution Drive Bedford, NH 03110 Phone (603) 472-4488 Fax (603) 472-9747 www.tfmoran.com
	F I L E 47361.00 DR RCK FB CK J.M. CAD:WETLAND_IMPACT_WITH_WILDLIFE-CORRIDOR	C-03

Dec 03, 2019 - 11:17am F:\MISC Projects\47361 - Portsmouth\47361-00 - Green & Co - Banfield Road\Design\Production Drawings\EXHIBIT\Wetland Impact_Wthr_Wildlife-Corridor.dwg

This Page is intentionally Blank

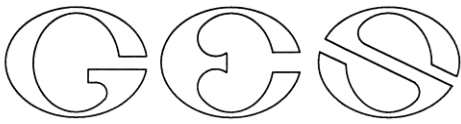

GOVE ENVIRONMENTAL SERVICES, INC.

2019 VERNAL POOL ASSESSMENT

Banfield Rd
Portsmouth, NH

1.0 INTRODUCTION

Gove Environmental Services, Inc. (GES) presents this Vernal Pool Monitoring Report for approximately 45 acres of land located off of Banfield Rd in Portsmouth, NH. The analysis contained in this report is based on the field assessment conducted during the 2019 breeding season

It addresses:

- Amphibian and other obligate species activity; and
- Existing conditions in the upland envelope surrounding the pool.

All field data collection and analysis for this report was conducted by GES.

Location and Site Description

The site is primarily comprised of undisturbed, open, mature forest dominated by oaks, pines, and maples. Areas of the property adjacent to or within wetland areas have a dominant scrub shrub understory comprised of highbush blueberry, winterberry, speckled alder and iron wood. The site has a large wetland complex which nearly surrounds the two defined upland lobes to the west. The terrain of the site is very distinct as there are prominent ledge outcrops in several areas on the site. The site has two utility right-of-ways which divide the property almost evenly into two blocks of land.

Regulations

NH Department of Environmental Services defines vernal pools, under Env- Wt 101.99 as a surface water or wetland, including an area intentionally created for purposes of compensatory mitigation, which provides breeding habitat for amphibians and invertebrates that have adapted to the unique environments provided by such pools and which:

- (a) Is not the result of on-going anthropogenic activities that are not intended to provide compensatory mitigation, including but not limited to:
- (1) Gravel pit operations in a pit that has been mined at least every other year; and
 - (2) Logging and agricultural operations conducted in accordance with all applicable New Hampshire statutes and rules; and
- (b) Typically has the following characteristics:
- (1) Cycles annually from flooded to dry conditions, although the hydroperiod, size, and shape of the pool might vary from year to year;
 - (2) Forms in a shallow depression or basin;
 - (3) Has no permanently flowing outlet;
 - (4) Holds water for at least 2 continuous months following spring ice-out;
 - (5) Lacks a viable fish population; and

8 Continental Dr Bldg 2 Unit H, Exeter, NH 03833-7526

Ph (603) 778 0644 / Fax (603) 778 0654

www.gesinc.biz

info@gesinc.biz

(6) Supports one or more primary vernal pool indicators, or 3 or more secondary vernal pool indicators.

2.0 METHODOLOGY

The assessment is based on the on-site review of areas that were previously observed as having potential for vernal pool habitat. Characteristics observed include: depth of the pool, the presence or lack of defined outlet or flow, and overall suitability of habitat for the amphibians to lay their eggs and for those eggs to persist.

Egg mass counts are conducted in these areas by slowly wading the pools while wearing polarized glasses for a better view through the water. Egg mass species identification was made using the professional experience of the biologist in conjunction with the publication *Vernal Pools: Natural History and Conservation*.¹ During surveys, adult amphibians and other vernal pool indicator species were noted. Other factors, which contribute to the significance of the pool, were also recorded including ponding depth, canopy cover, the character of the surrounding upland, and the presence of predator species. The following section provides a brief description of the pools assessed on site.

3.0 VERNAL POOL DESCRIPTIONS & DISCUSSION

In June of 2017, a preliminary site walk was done at the request of the client to perform an overall review of both previously flagged wetlands and newly flagged areas. During this preliminary site assessment four areas were observed as having potential vernal pool characteristics, however, due to the site walk taking place in June, it was not the appropriate time to perform a vernal pool assessment.

On April 25th 2019 GES conducted a reassessment of the potential vernal pools. Due to the location of the proposed development the vernal pool survey only focused on the assessment of potential vernal pools #1-3. During the assessment potential vernal pool area #3 was determined to be off property and thus was not further assessed. Potential vernal pool areas 1&2 were assessed using the aforementioned methodology and are described below.

Area #1:

This potential vernal pool area is located in the front of the site to the east and exists within a scrub shrub wetland that is bordered by Banfield Rd. as well as the utility right of way on property. The area primarily drains slowly from the west to the east along Banfield Rd. and settles out in an area of the utility right of way which then drains the water to the opposite side of Banfield Rd off site. During the assessment no adults wood frogs or spotted salamanders were observed. The area did have some standing water about 3-4 inches in the deepest areas. It is because of this observed lack of inundation the area was ruled out as having a suitable hydroperiod to be characterized as a viable vernal pool. No primary or secondary indicators were observed within this area.

¹ Colburn, Elizabeth A., Ph.D. *Vernal Pools: Natural History and Conservation*. Blacksburg, VA: McDonald and Woodward Publishing Company, 2004.



Area #2:

This potential vernal pool area is to the north of assessed potential vernal pool area #1. This area is within the contiguous wetland system that exists on the property and like Area 1 is within a large scrub shrub area bordered by the utility right of way. During the assessment no adult wood frogs or spotted salamanders were observed in the area. This area had similar inundation to area #1 with only a few inches of standing water at most. As the description of the first area addressed, this lack of inundation the area was ruled out as having a suitable hydroperiod to be characterized as a viable vernal pool. No primary or secondary indicators were observed within this area.



Photo Log
Representative photos taken in the fall of 2019.



Photo #1: Looking to the east at Potential Vernal Pool Area #1.



Photo #2: Looking at the base of the scrub-shrub vegetation noting there are no signs of persistent variable water depth that would support viable vernal pool habitat.



Photo #3: Looking at potential vernal pool area #2.



Photo #2: Looking at the base of the scrub-shrub vegetation noting there are no signs of persistent variable water depth that would support viable vernal pool habitat.

Vernal Pool Location Map



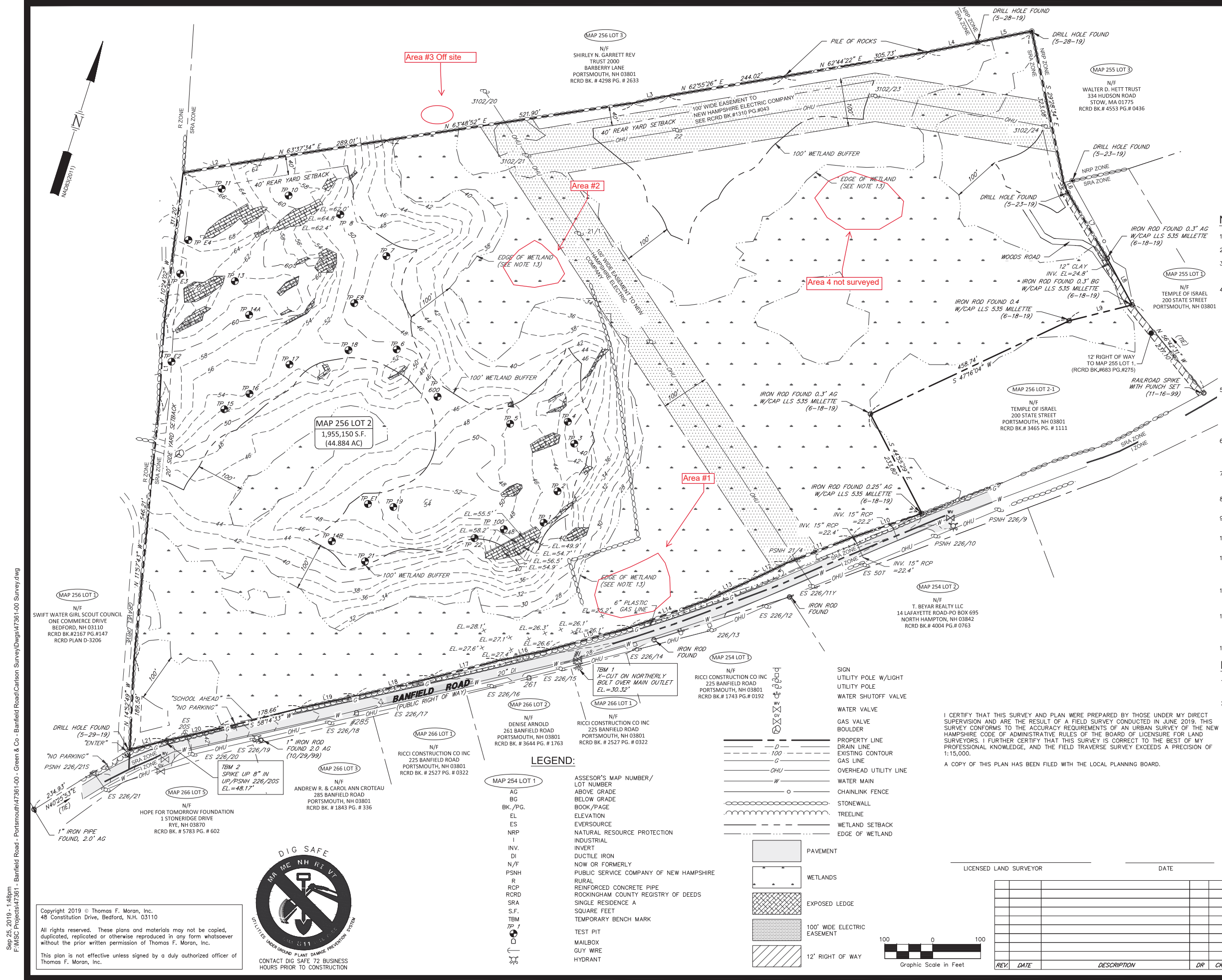

LINE	BEARING	DISTANCE
L1	N 14°03'49" W	163.61'
L2	N 62°46'56" E	140.17'
L3	N 83°47'10" E	174.31'
L4	N 61°20'44" E	105.56'
L5	N 60°58'42" E	115.75'
L6	S 40°08'01" E	22.98'
L7	S 48°30'23" E	159.80'
L8	S 45°44'06" E	110.28'
L9	S 58°19'16" W	135.27'
L10	S 53°23'55" W	154.49'
L11	S 51°04'17" W	145.81'
L12	S 45°41'16" W	85.08'
L13	S 48°05'39" W	99.00'
L14	S 52°42'56" W	173.00'
L15	S 57°03'44" W	173.81'
L16	S 62°20'11" W	108.27'
L17	S 57°50'14" W	143.89'
L18	S 59°00'53" W	162.66'
L19	S 60°14'59" W	117.96'
L20	S 59°39'51" W	113.08'
L21	S 58°23'21" W	176.30'

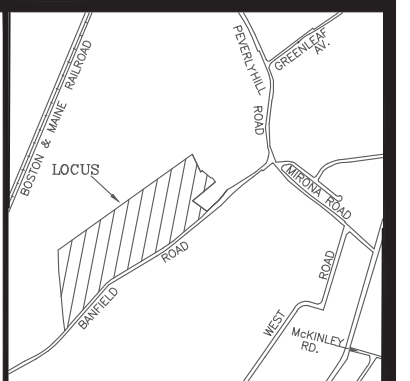

LOCATION PLAN

NOTES:

- THE PARCEL IS LOCATED IN THE SINGLE RESIDENCE A (SRA) ZONING DISTRICT.
- THE PARCEL IS SHOWN ON THE CITY OF PORTSMOUTH ASSESSOR'S MAP 256 AS LOT 2.
- THE PARCEL IS LOCATED IN ZONE X AS SHOWN ON NATIONAL FLOOD INSURANCE PROGRAM (NFIP), FLOOD INSURANCE RATE MAP (FIRM) ROCKINGHAM COUNTY, NEW HAMPSHIRE, PANEL 270 OF 681, MAP NUMBER 33015C0270E, WITH AN EFFECTIVE DATE OF MAY 17, 2005.
- DIMENSIONAL REQUIREMENTS:**
 MINIMUM LOT SIZE: 1 ACRE
 LOT AREA PER DWELLING UNIT: 1 ACRE
 CONTINUOUS STREET FRONTAGE: 150'
 LOT DEPTH: 200'
MINIMUM YARD DIMENSIONS:
 FRONT: 30'
 SIDE: 20'
 REAR: 40'
MAXIMUM STRUCTURE DIMENSIONS:
 STRUCTURE HEIGHT: 35'(SLOPED ROOF) 30'(FLAT ROOF)
 BUILDING COVERAGE: 10%
 MINIMUM OPEN SPACE: 50%
 PER THE CITY OF PORTSMOUTH ZONING ORDINANCE SECTION 10.520.
- OWNER OF RECORD:**
 MAP 256 LOT 2:
 THE WALTER D. HETT TRUST
 WALTER D. HETT, TRUSTEE
 334 HUDSON ROAD
 STOW, MA 01775
 RCRD BK.#4553 PG.#432
- PARCEL AREA:**
 MAP 256 LOT 2:
 1,955,150 S.F.
 (44.884 ACRES)
- THE INTENT OF THIS PLAN IS TO SHOW THE LOCATION OF BOUNDARIES IN ACCORDANCE WITH THE CURRENT LEGAL DESCRIPTIONS. IT IS NOT AN ATTEMPT TO DEFINE THE EXTENT OF OWNERSHIP OR DEFINE THE LIMITS OF TITLE.
- THE PURPOSE OF THIS PLAN IS TO SHOW THE BOUNDARY LINES, TOPOGRAPHY AND CURRENT SITE FEATURES OF MAP 256 LOT 2.
- FIELD SURVEY COMPLETED BY TCE AND EJS IN MAY & JUNE 2019 USING A TOPCON DS103 AND A TOPCON FC-5000 DATA COLLECTOR.
- HORIZONTAL DATUM IS NAD83 (2011) PER STATIC GPS OBSERVATIONS. THE VERTICAL DATUM IS NAVD88 (GEOID12B) PER STATIC GPS OBSERVATIONS. THE CONTOUR INTERVAL IS 2 FEET.
- EASEMENTS, RIGHTS, AND RESTRICTIONS SHOWN OR IDENTIFIED ARE THOSE WHICH WERE FOUND DURING RESEARCH PERFORMED AT THE ROCKINGHAM COUNTY REGISTRY OF DEEDS. OTHER RIGHTS, EASEMENTS, OR RESTRICTIONS MAY EXIST WHICH A TITLE EXAMINATION OF SUBJECT PARCEL(S) WOULD DETERMINE.
- THE LOCATION OF ANY UNDERGROUND UTILITY INFORMATION SHOWN ON THIS PLAN IS APPROXIMATE. TFMORAN, INC. MAKES NO CLAIM TO THE ACCURACY OR COMPLETENESS OF UNDERGROUND UTILITIES SHOWN. PRIOR TO ANY EXCAVATION ON SITE THE CONTRACTOR SHALL CONTACT DIG SAFE.
- WETLAND DELINEATION WAS COMPLETED BY GOVE ENVIRONMENTAL SERVICES IN MAY, 2019 IN ACCORDANCE WITH THE 1987 ARMY CORP OF ENGINEERS WETLAND MANUAL AND THE 2012 REGIONAL SUPPLEMENT TO THE CORPS OF ENGINEERS WETLAND DELINEATION MANUAL: NORTHCENTRAL AND NORTHEAST REGION. FIELD LOCATED BY TFMORAN, INC.
- SEE SHEET C-02 FOR TEST PIT LOGS.

PLAN REFERENCES:

- "SUBDIVISION PLAN FOR WALTER D. HETT & THE TEMPLE OF ISRAEL BANFIELD ROAD COUNTY OF ROCKINGHAM PORTSMOUTH, NH", BY MILLETTE, SPRAGUE, AND COLWELL, INC. DATED JUNE 25, 1999 WITH REVISION 3 DATED 12/02/99. RCRD PLAN D-27695.
- "PROPERTY OF SWIFTWATER GIRL SCOUT COUNCIL, CITY OF PORTSMOUTH" BY JON MOORE DATED AUGUST 1972. RCRD PLAN D-3206

I CERTIFY THAT THIS SURVEY AND PLAN WERE PREPARED BY THOSE UNDER MY DIRECT SUPERVISION AND ARE THE RESULT OF A FIELD SURVEY CONDUCTED IN JUNE 2019. THIS SURVEY CONFORMS TO THE ACCURACY REQUIREMENTS OF AN URBAN SURVEY OF THE NEW HAMPSHIRE CODE OF ADMINISTRATIVE RULES OF THE BOARD OF LICENSURE FOR LAND SURVEYORS. I FURTHER CERTIFY THAT THIS SURVEY IS CORRECT TO THE BEST OF MY PROFESSIONAL KNOWLEDGE, AND THE FIELD TRAVERSE SURVEY EXCEEDS A PRECISION OF 1:15,000.

A COPY OF THIS PLAN HAS BEEN FILED WITH THE LOCAL PLANNING BOARD.

- LEGEND:**
- ASSESSOR'S MAP NUMBER/ LOT NUMBER
 - AG ABOVE GRADE
 - BG BELOW GRADE
 - BK./PG. BOOK/PAGE
 - EL ELEVATION
 - ES EVERSOURCE
 - NRP NATURAL RESOURCE PROTECTION
 - I INDUSTRIAL
 - INV INVERT
 - DI DUCTILE IRON
 - N/F NOW OR FORMERLY
 - PSNH PUBLIC SERVICE COMPANY OF NEW HAMPSHIRE
 - R RURAL
 - RCRCD REINFORCED CONCRETE PIPE
 - SRA ROCKINGHAM COUNTY REGISTRY OF DEEDS
 - S.F. SINGLE RESIDENCE A
 - TEMPORARY BENCH MARK
 - TEST PIT
 - MAILBOX
 - GUY WIRE
 - HYDRANT
- SIGN
 - UTILITY POLE W/LIGHT
 - UTILITY POLE
 - WATER SHUTOFF VALVE
 - WATER VALVE
 - GAS VALVE
 - BOULDER
 - PROPERTY LINE
 - DRAIN LINE
 - EXISTING CONTOUR
 - GAS LINE
 - OHU OVERHEAD UTILITY LINE
 - W WATER MAIN
 - CHAINLINK FENCE
 - STONEWALL
 - TREELINE
 - WETLAND SETBACK
 - EDGE OF WETLAND

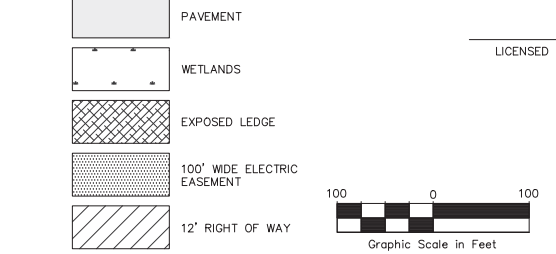

REV.	DATE	DESCRIPTION	DR	CK

TAX MAP 256 LOT 2
EXISTING CONDITIONS PLAN
BANFIELD ROAD
PORTSMOUTH, NEW HAMPSHIRE
COUNTY OF ROCKINGHAM
 OWNED BY
THE WALTER D. HETT TRUST
 PREPARED FOR
GREEN & COMPANY REAL ESTATE

SCALE: 1" = 100' (22x34)
1" = 200' (11x17)

SEPTEMBER 26, 2019

TFM **MSC**

Civil Engineers
 Structural Engineers
 Traffic Engineers
 Land Surveyors
 Landscape Architects
 Scientists

170 Commerce Way, Suite 102
 Portsmouth, NH 03801
 Phone (603) 431-2222
 Fax (603) 431-0910
 www.tfmoran.com

A division of **TFMoran, Inc.**

47361-00 DR EJS FB 559
 CK BMK CADFILE
 C-01

Copyright 2019 © Thomas F. Moran, Inc.
 48 Constitution Drive, Bedford, N.H. 03110

All rights reserved. These plans and materials may not be copied, duplicated, replicated or otherwise reproduced in any form whatsoever without the prior written permission of Thomas F. Moran, Inc.

This plan is not effective unless signed by a duly authorized officer of Thomas F. Moran, Inc.



This Page is intentionally Blank

*Memorandum*

Date: Friday, February 28, 2020
To: Peter Britz, Environmental Planner
Org: Portsmouth Planning Department, 1 Junkins Avenue, Portsmouth, NH 03801
From: Jim Gove
Re: Banfield Road Project for Green and Company
Subject: Response to Mark West Review of January 28, 2020 and questions related to Wildlife corridors as related to the site

The review points out that the Nature Conservancy shows the site in question as part of a prioritized habitat block and wildlife corridor. The GES, Inc. reports have identified the presence of wildlife corridors on the site of which there are many both on and off the site as summarized below.

As noted by the review, GES, Inc. identified the access road to the site as potentially limiting wildlife movement along that specific corridor. What has not been recognized is that numerous wildlife corridors exist over the entire site and the lands beyond. GES, Inc. has attached a plan showing the site and the surrounding areas. The plan is named "Upland/Wetland Habitat Map". The base map is an infrared aerial photo with the wetlands boundaries (outside of the site) being interpreted and the wetlands shown colored in green and the wildlife corridors have been shown as black arrows.

There are numerous wildlife corridors on and off the site. Wildlife movement is not confined to just the areas of the development but are present around the site and in adjacent parcels. Most movement is along drainage ways, valleys, edges of wetlands, and along any streams. Wildlife also moves along man-made corridors, like railroad tracks and electric powerlines. Less movement is over the tops of hills, rock outcrops, and steep areas. The wildlife has many ways to move around the area, and move around the proposed development.

Of the numerous wildlife corridors shown, only two would be limited by the development.

- a. The first is at the wetland impact area along Banfield Road. In the West review, there was a concern that the proposed eco-passage was built with less height than recommended. The recommendation for the eco-passages is 2 feet high, with an opening of 2 feet wide. In redesigning this area, the eco-passages have been changed in the design, and are now proposed to have heights of 1.9 feet, 2.0 feet, and 2.2 feet. The openings all have a width of 5 feet which is 2.5 times larger than recommended, allowing for better wildlife passage. Where typically only one eco-passage is used, the project is proposing three eco-passages. The eco-passages now meet or exceed the recommended design. As discussed at the

Conservation Commission meeting, these eco-passages are to help reptile and amphibian species to continue to move in the wetland. Also, the height of the access road across the wetlands is from 1.4 feet tall to 2.7 feet tall. This height of road will not be an impediment to deer, fox, coyote, raccoon, skunk, weasel, fisher, squirrel and chipmunk. There will continue to be wildlife movement through this corridor.

- b. The second is a valley between the two lobes of the development. The West review noted that the large retaining walls connecting the two development areas will permanently impact wildlife movement because the walls were up to 10 feet high and West recommended the elimination of the large retaining walls. In redesigning this area the retaining wall for the road connecting the two development areas is now reduced to 2 feet to 3.2 feet in height. This height will not be an impediment from the movement of mammals crossing along the corridor. As discussed above, deer, fox, coyote, skunk, raccoon, fisher, weasel, squirrel, or chipmunk will not find a 2-foot retaining wall an impediment to crossing through the valley between the two wetland areas. Further, the retaining wall is only on the north side of the proposed road, with the south side having no retaining wall.

These modifications clearly show that the Applicant has significantly minimized these impacts to these 2 travel corridors.

Another important point to note is that there has been discussion about the development area being the only upland on site, and that it is the only island of upland habitat in the area and is surrounded by wetlands. The Upland/Wetland Habitat Map shows that this is in fact not the case. To the south, west and north of the development site are large areas of uplands. Going west from the development envelope is an uninterrupted continuous tract of upland habitat. To the south, after crossing a wetland, is another tract of upland. To the north, after crossing a wetland, is another tract of uplands.

On the site, of the 44.8 acres making up the subject property, 19.34 acres is wetlands and 25.46 acres of upland, with only 7.3 acres of upland and 0.09 acres of wetland for the crossing being used for the development area. This means that on the site, outside of the development envelope, is 18.2 acres of upland, which means approximately 40% of the 44.88 acre site will remain as undeveloped upland and approximately 83% of the 44.8 acre site will remain undeveloped overall.

In the West review, a recommendation was to provide information as to how the open space area will be managed and protected from future impact. The following is adapted from the Open Space restrictions of a condominium project in Atkinson:

The Open Space as depicted on the plans, is and shall forever be and remain subject to the following deed restrictions:



- 1) The purpose of the Open Space after completion of the proposed development depicted on the site plan is to retain the area forever in its scenic and open space conditions and to prevent any use of the Open Space that will significantly impair, or interfere with, its conservation value.
- 2) To protect and conserve the natural biological diversity of the region including exemplary natural communities, wetlands and other significant wildlife habitats on the restricted property.
- 3) It shall be maintained in perpetuity as open space.
- 4) No structure of any kind, size or shape shall be constructed on the Open Space.
- 5) Upon completion of the proposed development, no filling or excavation of soil or other alteration of topography or cutting or removal of standing trees shall be allowed, except those that present an imminent threat to person or property. In addition, trees may be removed in accordance with accepted silvicultural forest practices as outlined in the publication entitled **Good Forestry Practices in the Granite State** by the Society for the Protection of NH Forests. No disturbance of other natural features shall be allowed unless such activities are commonly necessary to maintain the existing natural environment of the open space.
- 6) There shall be no dumping or depositing of trash, debris, stumps, yard waste, hazardous fluid or materials, vehicle bodies or parts within the Open Space.

There has been discussion that there may be an alternative access to the site via an abutting parcel of land. The abutting parcel is not owned by the project and it --was found not to be available to the project. In addition, the abutting property -- would also require a longer wetland crossing to access uplands. This is not a feasible access because it is not the least impacting alternative and is not owned by the project. Therefore, the proposed access road at the location depicted on Banfield Road is the least impacting alternative.

Copy to:

NH DES Wetlands Bureau Application# 2020-0344.
Amended plans of eco-passages.

Attachments:

- 1) West Environmental Inc. letter of 01-28-2020
- 2) Upland/Wetland Habitat Plan
- 3) Eco-passage cross-section
- 4) RetainWall cross-section



THIS PAGE IS INTENTIONALLY BLANK

Peter Britz, Environmental Planner
Portsmouth Planning Department
1 Junkins Avenue
Portsmouth, NH 03801

January 28, 2020

RE: Third Review of Banfield Road Project Green and Company Portsmouth

Dear Peter:

West Environmental, Inc. (WEI) submits this third review report of the above referenced project based on information presented by the applicant at the December 11, 2019. Some of the new information presented addressed issues raised in our report from December 10, 2019 but no formal response to the report was submitted.

2019 Wildlife Habitat Assessment

As discussed in our 12-10-19 report the revised Wildlife Habitat Assessment (WHA) provides more information on wildlife habitat and the species that likely utilize this site. We have attached the Connect the Coast Map prepared by the Nature Conservancy indicating that the Hett parcel to be developed is within a Prioritized Habitat Block. In addition, this map confirms that wildlife movement is in an east-west direction.

WEI agrees with the statement "*The greatest issue with this development is the bisecting of the site with the proposed road, limiting any existing and potential wildlife travel.*" The reports from Gove Environmental indicate that development itself and the large retaining walls in the stretch of road connecting the two development areas **will permanently impact wildlife movement on the site**. The applicant's consultants presented information regarding the retaining walls (up to 10 feet high) and the proposed 4'x4' box culvert. While we understand that this design eliminated impacts to the wetland buffers the road itself now has a greater impact to wildlife movement.

The eco-passage located at the wetland crossing was also presented at the Conservation Commission Meeting to help reptile and amphibian species continue to move through the wetland. It is proposed to be built with less height than is recommended which may reduce its effectiveness to promote passage. WEI recommended consultation with the NH Fish and Game and we have reviewed email correspondence with Kim Tuttle.

She indicated that the design was interesting and had some basic recommendations but did not endorse the design. She also referred the applicant to Sandi Houghton at her office.

It is our understanding that the hydrology and septic designs are being independently reviewed.

Recommendations:

1. The applicant's consultants should examine alternative stormwater management designs that eliminate the large retaining walls in the under-road detention option and distribute the treatment systems into smaller watersheds. Some impact in the outer 25 feet of the 100-foot wetland buffer for smaller detention/treatment systems would have less impact on wildlife. These areas could also be planted with shrub buffers on their outer slopes to minimize habitat impact. There are also areas outside the 100-foot buffers where rain gardens could be located.
2. The applicant's consultants should continue to research the eco-passages to verify that they will function with an altered design.
3. The applicant should provide information as to how the open space area will be managed and protected from future impact. This element of the project is the most important mitigation for wildlife habitat impacts and it will require signage and other permanent restrictions.

Sincerely,
West Environmental, Inc.

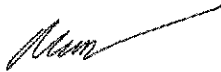

Mark C. West,
NH Certified Wetland Scientist

Cc: Vicky Nelson

Upland Wetland Habitat Map

Prepared By: Gove Environmental Services, Inc.
Date: 2/27/2020
BW 1 Inch = 400 Feet

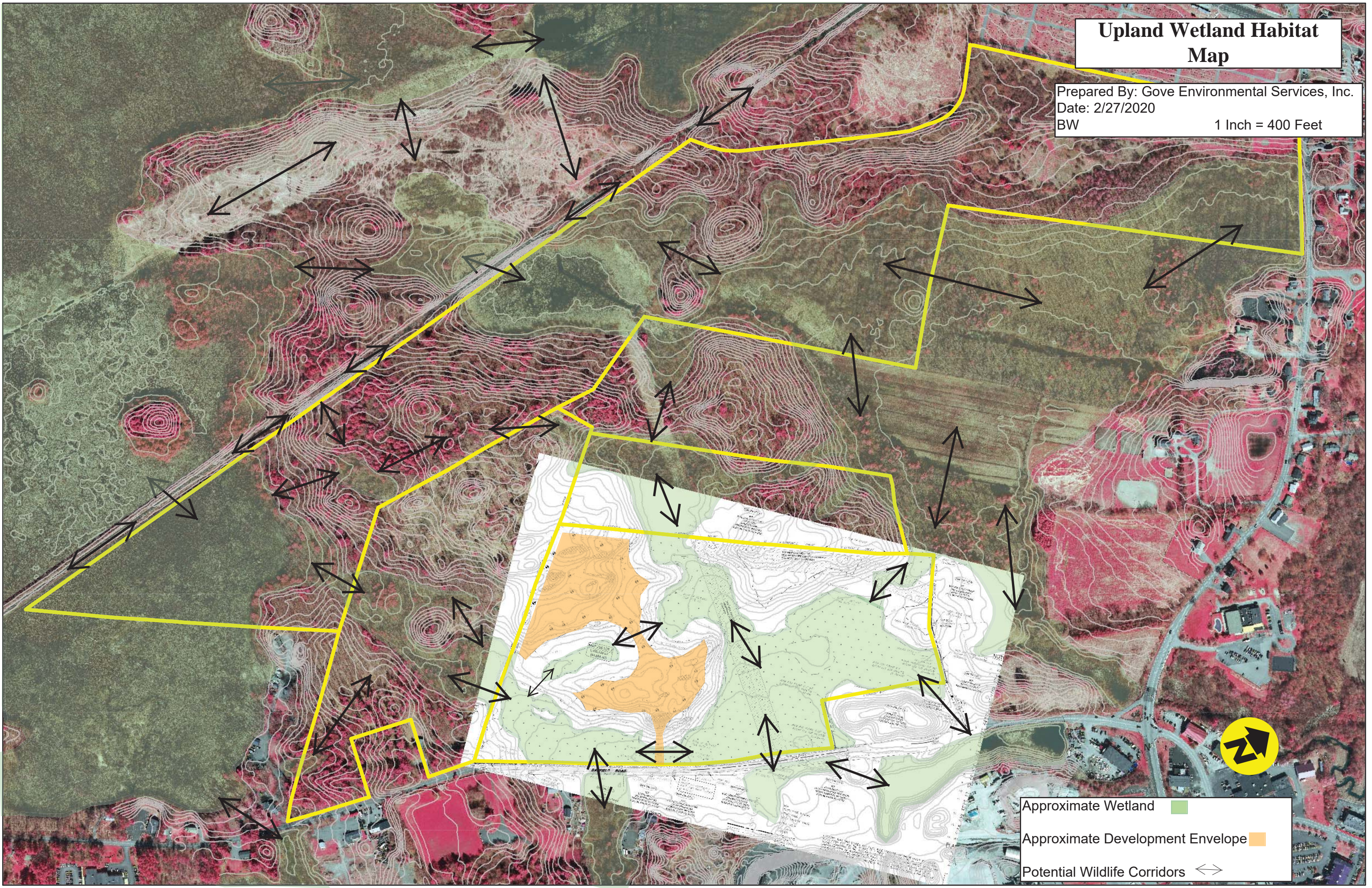

Approximate Wetland 

Approximate Development Envelope 

Potential Wildlife Corridors 

THIS PAGE IS INTENTIONALLY BLANK

James P. Gove, CSS, CWS; CPSC; CPESC
President

James P. Gove is President of Gove Environmental Services, Inc

Mr. Gove's particular areas of expertise include wetland delineation procedures, wetland impact permitting, wetland mitigation and restoration, site-specific soil surveys, hydric soil assessments, and soil profile analysis. He has been working in the field of soil and wetland science since 1978, including eight years as a Soil Scientist with the US Department of Agriculture Soil Conservation Service. Mr. Gove is recognized by the national ARCPACS organization as a Certified Professional Soil Classifier, by the Soil and Water Conservation Society as a Certified Professional in Erosion and Sediment Control, and by the State of New Hampshire as both a Certified Soil Scientist and a Certified Wetland Scientist.

Mr. Gove's professional activities have included terms as Chairman and Vice Chairman on the NH Board of Natural Scientists; President of the NH Association of Wetland Scientists; testimony before the NH Legislature; the Ad-Hoc Committee for Soil-Based Lot Sizing, and the NHDES Ad-Hoc Committees; President of the Society of Soil Scientists of Northern New England; member of the New England Hydric Soils Technical Committee; contributor to *Field Indicators for Identifying Hydric Soils in New England*; and co-author of the *High Intensity Soil Mapping Standards*.



The State of New Hampshire
Department of Environmental Services



Robert R. Scott, Commissioner

May 18, 2020

MAUD HETT REVOCABLE TRUST
 WALTER D HETT TTEE
 334 HUDSON RD
 STOW MA 01775

Re: Wetlands Permit Approval (RSA 482-A)
NHDES File Number: 2020-00344
Subject Property: Banfield Rd, Portsmouth, Tax Map #256, Lot #2

Dear Mr. Hett:

Attached please find Wetlands Permit # 2020-00344 to dredge and fill 2,693 square feet of palustrine forested wetland for access to a buildable upland for a multi-unit residential development. In addition, temporarily impact 1,135 square feet of palustrine wetland for construction and installation.

The decision to approve this project was based on the following findings:

1. This is classified as a minor impact project per Rule Env-Wt 524.06(c)(4), as no component of the residential development project meets the requirements for major impact classification specified in Env-Wt 407, Env-Wt 903, or Chapter 500 Administrative Rules.
2. Per Rule Env-Wt 306.05, the applicant has addressed all of the required planning items that are used to determine the appropriate impact classification of a project and the type of approval required.
3. Per Rule Env-Wt 313.03(a), the applicant has demonstrated that potential impacts to jurisdictional areas have been avoided to the maximum extent practicable and that any unavoidable impacts have been minimized.
4. The applicant has demonstrated specifically that each factor listed in Env-Wt 313.03(b) has been considered in the design of the proposed minor project.
5. The residential development project meets the all of the approval criteria established in Env-Wt 524.02.
6. The project includes uniquely designed wildlife passage to protect and maintain hydrologic connection and existing wildlife-dependent habitat and associated migratory pathways, per Rule Env-Wt 313.03(b) and 524.04(f).
7. Per Rule Env-Wt 313.01(a)(5), and as required by RSA 482-A:11, II, this permit for work to dredge or fill will not 'infringe on the property rights or unreasonably affect the value or enjoyment of property of abutting owners' based on documentation that the proposed dredge and fill activity will be located entirely within the boundary of the applicant's property interest and will not result in any observable change in off-site surface water levels or flows.
8. Per Rule Env-Wt 311.06(h), the municipal conservation commission recommended denial of the proposed project on March 13, 2020. The applicant has addressed all concerns raised relative to the jurisdiction of this review.

9. In correspondence dated March 05, 2020, comments of concern were received by NHDES from the abutting property owner. However, the concerns raised are beyond the scope of jurisdiction of this review.
10. Per Rule Env-Wt 313.01(a)(2), all applicable conditions specified in Env-Wt 307 have been met.
11. Per Rule Env-Wt 313.01(a)(1)(a), the applicant has met the requirements of Env-Wt 311.10 regarding functional assessments.
12. Per Rule Env-Wt 311.01(b), the applicant coordinated with the NH Fish and Game Department (NHF&G) and the Natural Heritage Bureau (NHB) to determine how to avoid and minimize project-related impacts on rare or protected animal species and habitat, and on protected plants or exemplary natural communities.

Any person aggrieved by this decision may appeal to the NH Wetlands Council (the Council) by filing an appeal that meets the requirements specified in RSA 482-A:10, RSA 21-O:14, and the rules adopted by the Council, Env-WtC 100-200. The appeal must be filed **directly with the Council within 30 days** of the date of this decision and must set forth fully **every ground** upon which it is claimed that the decision complained of is unlawful or unreasonable. Only those grounds set forth in the notice of appeal can be considered by the Council.

Information about the Council, including a link to the Council's rules, is available at <http://nhec.nh.gov/> (or more directly at <http://nhec.nh.gov/wetlands/index.htm>.) Copies of the rules also are available from the NHDES Public Information Center at (603) 271-2975.

If you have any questions, please contact the NHDES Wetlands Bureau at (603) 271-2147.

Sincerely,

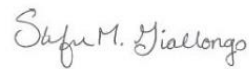

Stefanie M. Giallongo
Wetlands Specialist
Land Resources Management, Water Division

cc: Portsmouth Municipal Clerk/Conservation Commission
Brenden Walden, Gove Environmental Services

ec: Ridge Mauck, NHDES Alteration of Terrain Bureau



The State of New Hampshire
Department of Environmental Services



Robert R. Scott, Commissioner

=====

WETLANDS AND NON-SITE SPECIFIC PERMIT 2020-00344

NOTE CONDITIONS

PERMITTEE: MAUD HETT REVOCABLE TRUST
WALTER D HETT TRUSTEE
334 HUDSON RD
STOW MA 01775

PROJECT LOCATION: BANFIELD RD, PORTSMOUTH
TAX MAP #256, LOT #2

WATERBODY: UNNAMED WETLAND

APPROVAL DATE: MAY 18, 2020

EXPIRATION DATE: MAY 18, 2025

=====

Based upon review of the above referenced application, in accordance with RSA 482-A and RSA 485-A:17, a Wetlands Permit and Non-Site Specific Permit was issued by the New Hampshire Department of Environmental Services (NHDES). This permit shall not be considered valid unless signed as specified below.

PERMIT DESCRIPTION: Dredge and fill 2,693 square feet of palustrine forested wetland for access to a buildable upland for a multi-unit residential development. In addition, temporarily impact 1,135 square feet of palustrine wetland for construction and installation.

THIS APPROVAL IS SUBJECT TO THE FOLLOWING PROJECT SPECIFIC CONDITIONS:

1. All work shall be done in accordance with the approved plans dated September 25, 2019, revised through February 10, 2020 by TFM, Inc., as received by the NH Department of Environmental Services (NHDES) on February 26, 2020, in accordance with Env-Wt 307.16.
2. The permittee shall submit a construction notice with the department at least 48 hours prior to commencing work, in accordance with Env-Wt 524.05(a).
3. Water quality control measures shall be comprised of wildlife-friendly erosion control materials, not to be composed of welded plastic, if erosion control blankets are utilized, in accordance with Env-Wt 307.03(c)(2).
4. Fill shall be clean sand, gravel, rock, or other material that meets the project's specifications for its use; and does not contain any material that could contaminate surface or groundwater or otherwise adversely affect the ecosystem in which it is used, in accordance with Env-Wt 307.11(a).
5. Slopes shall be immediately stabilized by a method specified in Env-Wq 1506 or Env-Wq 1508, as applicable, to prevent erosion into adjacent wetlands or surface waters, in accordance with Env-Wt 307.11(c).
6. Prior to construction, any heavy machinery shall be inspected for and cleaned of all vegetative matter by a method and in a location that prevents the spread of the vegetative matter to jurisdictional areas, in accordance with Env-Wt 307.05(a).
7. To prevent the use of soil or seed stock containing nuisance or invasive species, the contractor responsible for work shall follow Best Management Practices for the Control of Invasive and Noxious Plant Species (Invasive Plant BMPs), in accordance with Env-Wt 307.05(e).
8. Mulch used within an area being restored shall be natural straw or equivalent non-toxic, non-seed-bearing organic material, in accordance with Env-Wt 307.12(d).

9. All work, including management of soil stockpiles, shall be conducted so as to minimize erosion, minimize sediment transfer to surface waters or wetlands, and minimize turbidity in surface waters and wetlands using the techniques described in Env-Wq 1505.02, Env-Wq 1505.04, Env-Wq 1506, and Env-Wq 1508; the applicable BMP manual; or a combination thereof, if the BMP manual provides less protection to jurisdictional areas than the provisions of Env-Wq 1500, in accordance with Env-Wt 307.03(b).
10. Mobile heavy equipment working in wetlands shall not be stored, maintained, or repaired in wetlands, except that repairing or refueling in a wetland is allowed if equipment cannot practicably be removed and secondary containment is provided, in accordance with Env-Wt 307.15(b).
11. The person in charge of construction equipment shall inspect such equipment for leaking fuel, oil, and hydraulic fluid each day prior to entering surface waters or wetlands or operating in an area where such fluids could reach groundwater, surface waters, or wetlands, in accordance with Env-Wt 307.03(g)(1).
12. The person in charge of construction equipment shall maintain oil spill kits and diesel fuel spill kits, as applicable to the type(s) and amount(s) of oil and diesel fuel used, on site so as to be readily accessible at all times during construction; and train each equipment operator in the use of the spill kits, in accordance with Env-Wt 307.03(g)(3) and (4).
13. Wetland areas where permanent impacts are not authorized shall be restored to their pre-impact conditions and elevation by replacing the removed soil and vegetation in their pre-construction location and elevation such that post-construction soil layering and vegetation schemes are as close as practicable to pre-construction conditions, in accordance with Env-Wt 307.12(i).
14. If any temporary impact area that is stabilized with seeding or plantings does not have at least 75% successful establishment of wetlands vegetation after 2 growing seasons, the area shall be replanted or reseeded, as applicable, in accordance with Env-Wt 307.12(f). Restored areas shall not be deemed successful if invaded by nuisance species during the first full growing season following the completion of construction.

GENERAL CONDITIONS THAT APPLY TO ALL NHDES WETLANDS PERMITS:

1. Pursuant to RSA 482-A:12, a copy of the permit shall be posted in a secure manner in a prominent place at the site of the approved project.
2. In accordance with Env-Wt 313.01(a)(5), and as required by RSA 482-A:11, II, work shall not infringe on the property rights or unreasonably affect the value or enjoyment of property of abutting owners.
3. In accordance with Env-Wt 314.01, a standard permit shall be signed by the permittee and the principal contractor who will build or install the project prior to start of construction; and will not be valid until signed.
4. In accordance with Env-Wt 314.03(a), the permittee shall notify the department in writing at least one week prior to commencing any work under the permit.
5. In accordance with Env-Wt 314.08(a), the permittee shall file a completed notice of completion of work and certificate of compliance with the department within 10 working days of completing the work authorized by the permit.
6. In accordance with Env-Wt 314.06, transfer of this permit to a new owner shall require notification to and approval by NHDES.
7. In accordance with Env-Wt 307.02, in order to be in compliance with federal requirements, all work in areas under the jurisdiction of the U.S. Army Corps of Engineers (US ACE) shall comply with all conditions of the applicable state general permit (see attached notice).
8. In accordance with Env-Wt 307.06(a) through (c), no activity shall jeopardize the continued existence of a threatened or endangered species, a species proposed for listing as threatened or endangered, or designated or proposed critical habitat under the Federal Endangered Species Act, 16 U.S.C. §1531 et seq.; State Endangered Species Conservation Act, RSA 212-A; or New Hampshire Native Plant Protection Act, RSA 217-A. A copy of this permit shall be posted on site during construction in a prominent location visible to inspecting personnel.

APPROVED:

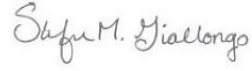

Stefanie M. Giallongo
Land Resources Management, Water Division

=====

BY SIGNING BELOW, I HEREBY CERTIFY THAT I HAVE FULLY READ THIS PERMIT AND AGREE TO ABIDE BY ALL PERMIT CONDITIONS.

OWNER'S SIGNATURE (required)

CONTRACTOR'S SIGNATURE (required)

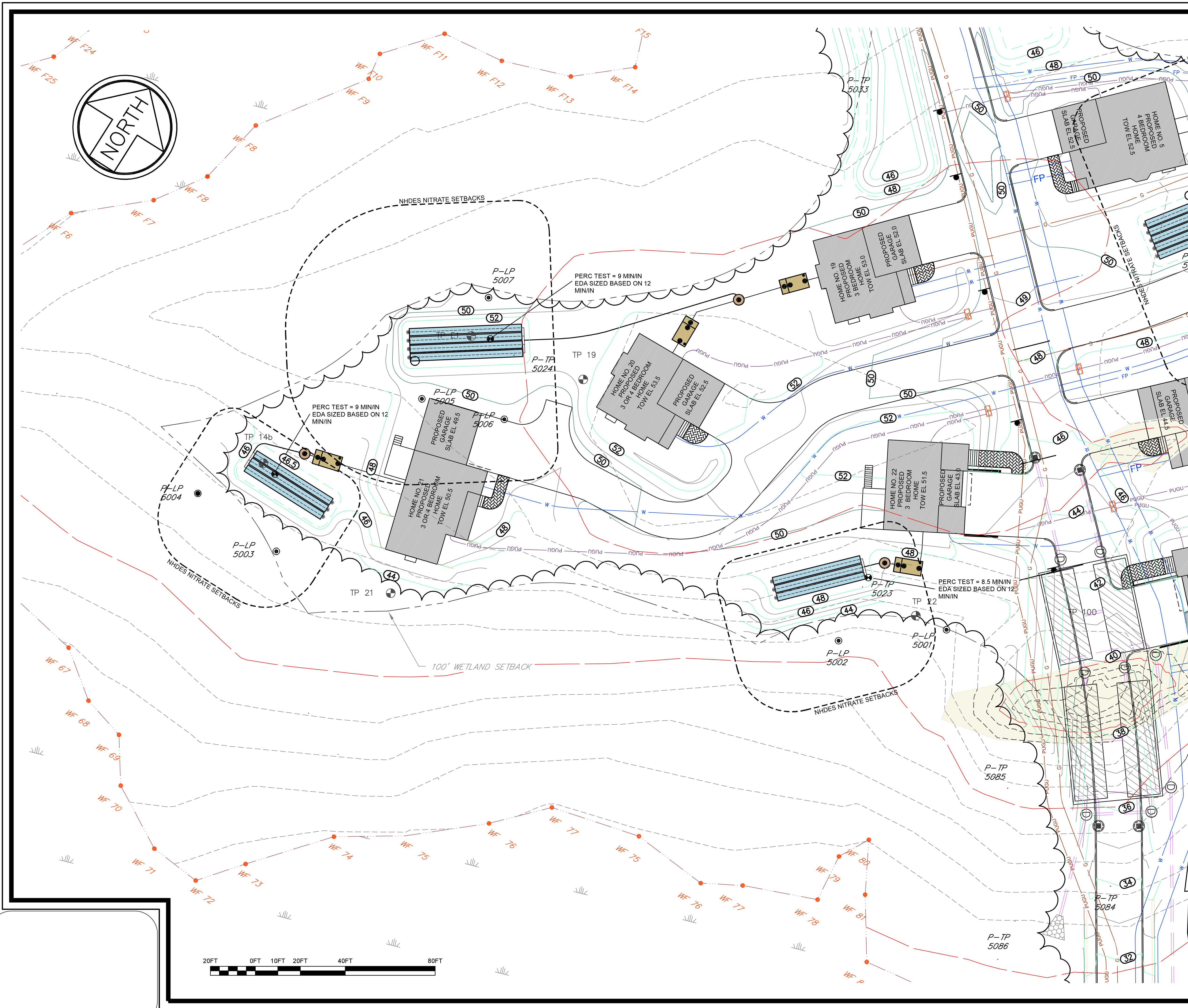

GENERAL NOTES:

1. THIS PLAN SHOWS THE PROPOSED LAYOUT OF EFFLUENT DISPOSAL AREAS (EDA'S) FOR THE PROPOSED DEVELOPMENT. THIS PLAN IS NOT TO BE USED FOR CONSTRUCTION OF THE EDA'S.
2. NHDES CONSTRUCTION APPROVAL IS REQUIRED PRIOR TO CONSTRUCTION.
3. SEE SITE DEVELOPMENT PLANS PREPARED BY TFM. ANY DISCREPANCY BETWEEN THIS PLAN, SITE DEVELOPMENT PLANS AND THE FIELD CONDITIONS TO BE REPORTED TO THE DESIGNER PRIOR TO CONSTRUCTION.
4. ALL TOWN AND NHDES APPROVALS ARE REQUIRED PRIOR TO STARTING CONSTRUCTION.
5. APPROVAL OF THIS PLAN ALLOWS FOR THE CONSTRUCTION OF AN ISDS ONLY. SEE SITE DEVELOPMENT PLANS FOR ALL OTHER INFORMATION.
6. PRIOR TO USING VERIFY THE SCALE OF THE DRAWING BY CHECKING THE BAR SCALE PRINTED ON THE PLAN. REPRODUCTION OF THE DRAWING MAY RESULT IN ERRORS WHEN SCALING FROM DRAWING. IF A CRITICAL DIMENSION IS REQUIRED AND NOT SHOWN ON THE PLAN, CONSULT WITH THE DESIGNER.
7. DO NOT SCALE FROM DRAWING. IF A REQUIRED DIMENSION IS NOT GIVEN, CONSULT WITH THE DESIGNER.

GEOMAT CONSTRUCTION NOTES

1. INSTALLER SHALL FOLLOW LATEST MANUFACTURER'S INSTALLATION GUIDELINES AND HAVE REVIEWED THE GEOMAT MANUAL APPROVED BY NHDES.
2. ALL TREES, TOPSOIL, ROOTS, AND ORGANIC MATTER MUST BE REMOVED FROM THE AREA TO BE FILLED. OUT TO AND INCLUDING THE AREA UNDER THE FILL EXTENSION TO THE TOE OF SLOPE.
3. CONTRACTOR TO PROTECT BASAL AREAS FROM SILTATION AND COMPACTION DURING CONSTRUCTION.
4. FILL MATERIAL USED TO BRING THE GRADE TO WITHIN 6" OF THE BED BOTTOM SHALL MEET NHDES Env-Wq 1021.03 (FILL MATERIAL). IN ADDITION FILL SHALL NOT BE FROZEN OR EXCEED THE PERC RATE OF THE PARENT MATERIAL. FILL SHALL BE PLACED IN 12" LIFTS. FILL TO BE MIXED INTO THE NATURAL SOIL TO A DEPTH OF 12"
5. THE FIRST 6" OF MATERIAL BELOW AND 18" BEYOND THE EDGE OF THE GEOMAT UNITS MUST MEET THE MOST RECENT SAND BEDDING REQUIREMENTS OF THE MANUFACTURER. (ASTM-C33 SEPTIC SAND)
6. A SIMTECH PRESSURE EFFLUENT FILTER IS RECOMMENDED WHEN EFFLUENT IS PUMPED TO A GRAVITY GEOMAT SYSTEM.
7. SIMTECH PRESSURE EFFLUENT FILTER IS REQUIRED WHEN EFFLUENT IS PUMPED TO A PRESSURE DISTRIBUTION GEOMAT SYSTEM.
8. VENTING IS NOT ALLOWED WITH THE GEOMAT SYSTEM.
9. A SOILAIR UNIT MUST BE INSTALLED WHEN THE DEPTH OF COVER OVER THE GEOMAT SYSTEM IS 24" OR GREATER
10. THE GEOMAT SYSTEM IS NOT RATED FOR H-20 LOADS
11. SEPTIC TANK ACCESS STACKS SHALL BE BROUGHT TO WITHIN 6" OF THE FINISH GRADE.
12. ACCESS STACKS THAT HAVE AN EFFLUENT FILTER SHALL BE BROUGHT TO GRADE.
13. SYSTEMS THAT REQUIRE AN EFFLUENT PUMP - ACCESS TO THE PUMP CHAMBER SHALL BE BROUGHT TO GRADE.
14. INSTALLER SHALL SEAL THE SEPTIC TANK(S) / PUMP CHAMBER AND ALL PIPE PENETRATIONS TO PREVENT GROUND WATER INFILTRATION.
15. THERE SHALL BE A MINIMUM 4" (COMPACTED) OF LOAM SUITABLE FOR SEEDING ON ALL DISTURBED AREAS. ALL AREAS SHALL BE STABILIZED WITH MULCH OR HYDRO SEEDING. ALL LAWN AREAS SHALL BE RAKED PRIOR TO PLACING SEED.

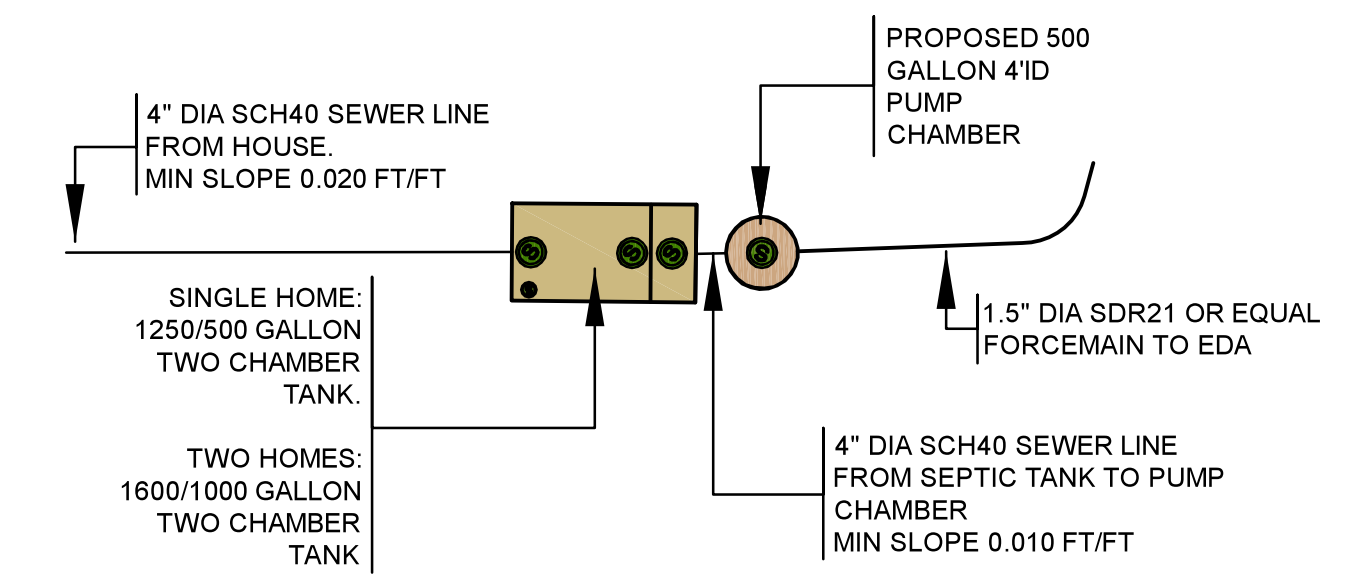

SEPTIC TANK AND PUMP CHAMBER LAYOUT (TYP)

**OVERVIEW LAYOUT OF ISDS
FOR HOMES 19 - 22
Tax Map 256 Lot 2
BANFIELD ROAD
PORTSMOUTH, NH**

SCALE: 1"=20'

DATE: APRIL 22, 2020

OWNER:
WALTER D HETT TRUST

PREPARED FOR:
**PREPARED FOR
GREEN & COMPANY**

g.r.spaulding design consultants, LLC
 providing a balance between growth and the environment
 PO BOX 248, CANTERBURY, NH 03224
 Phone (603) 496-9797
 spauldingdesignllc@comcast.net

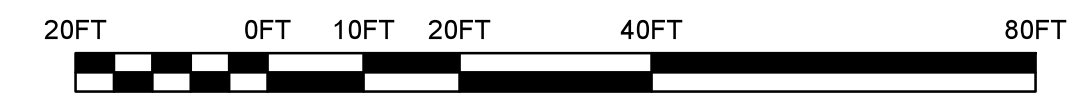
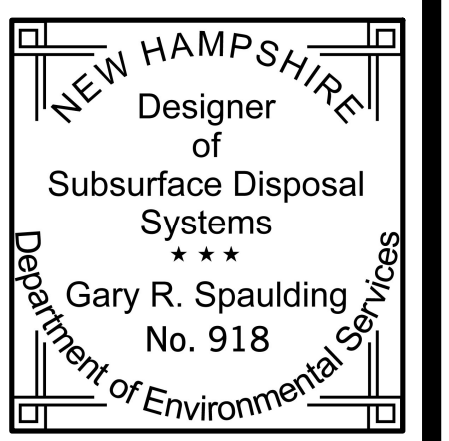

REV.	DATE	DESCRIPTION
1		

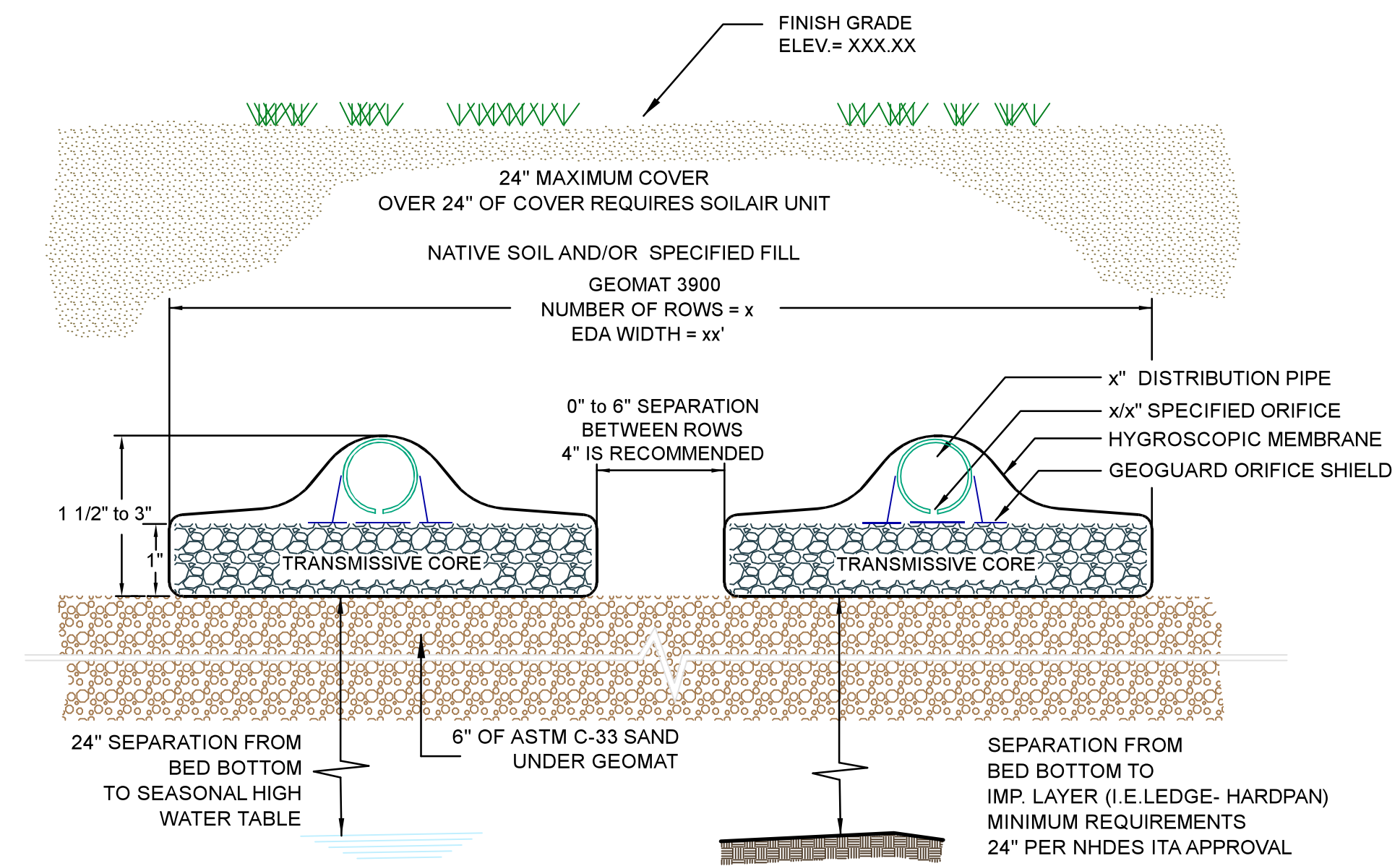
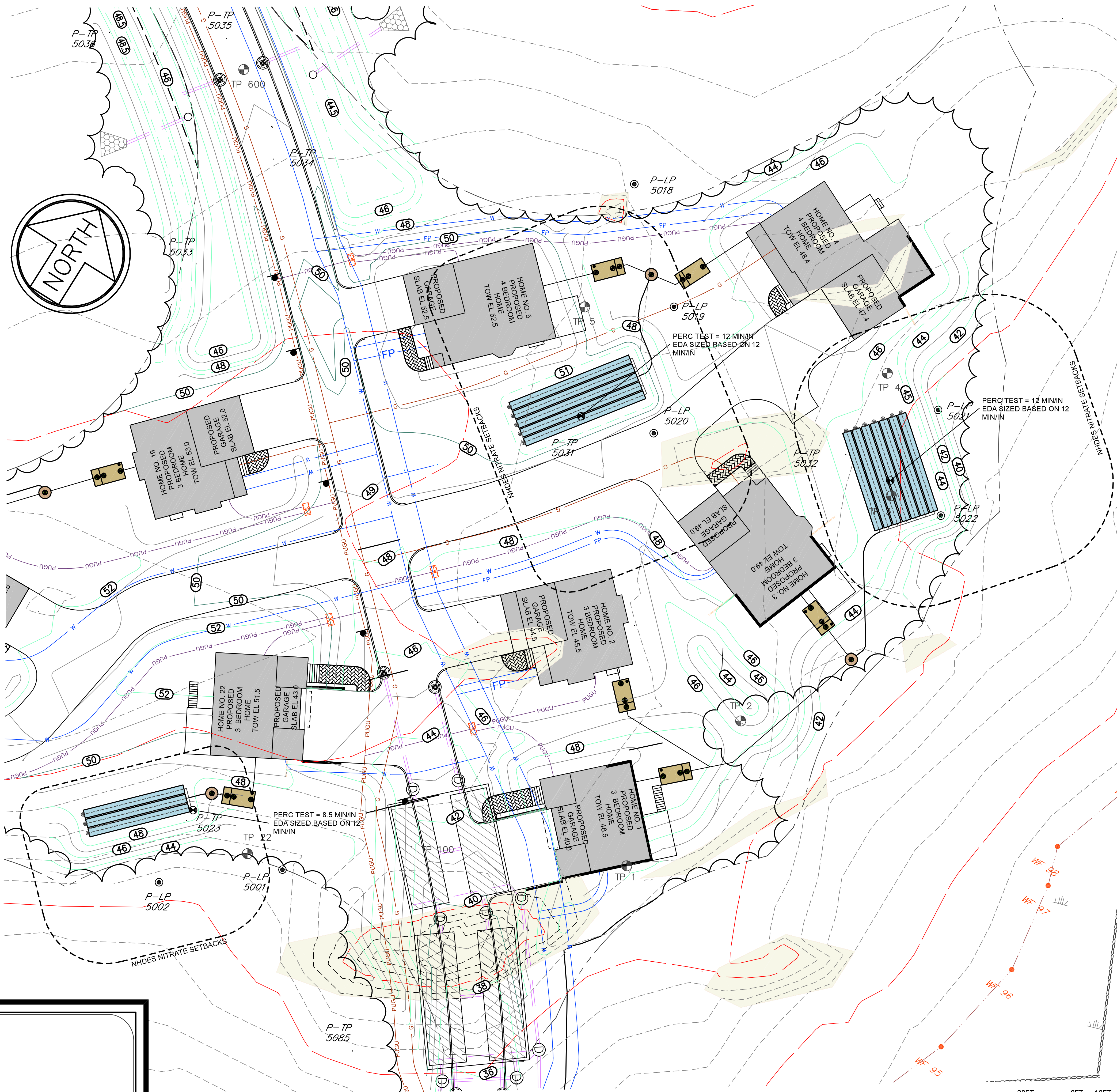

GEOMAT™ 3900 LEACHING SYSTEM PRESSURE DOSED CROSS SECTION
NOT TO SCALE

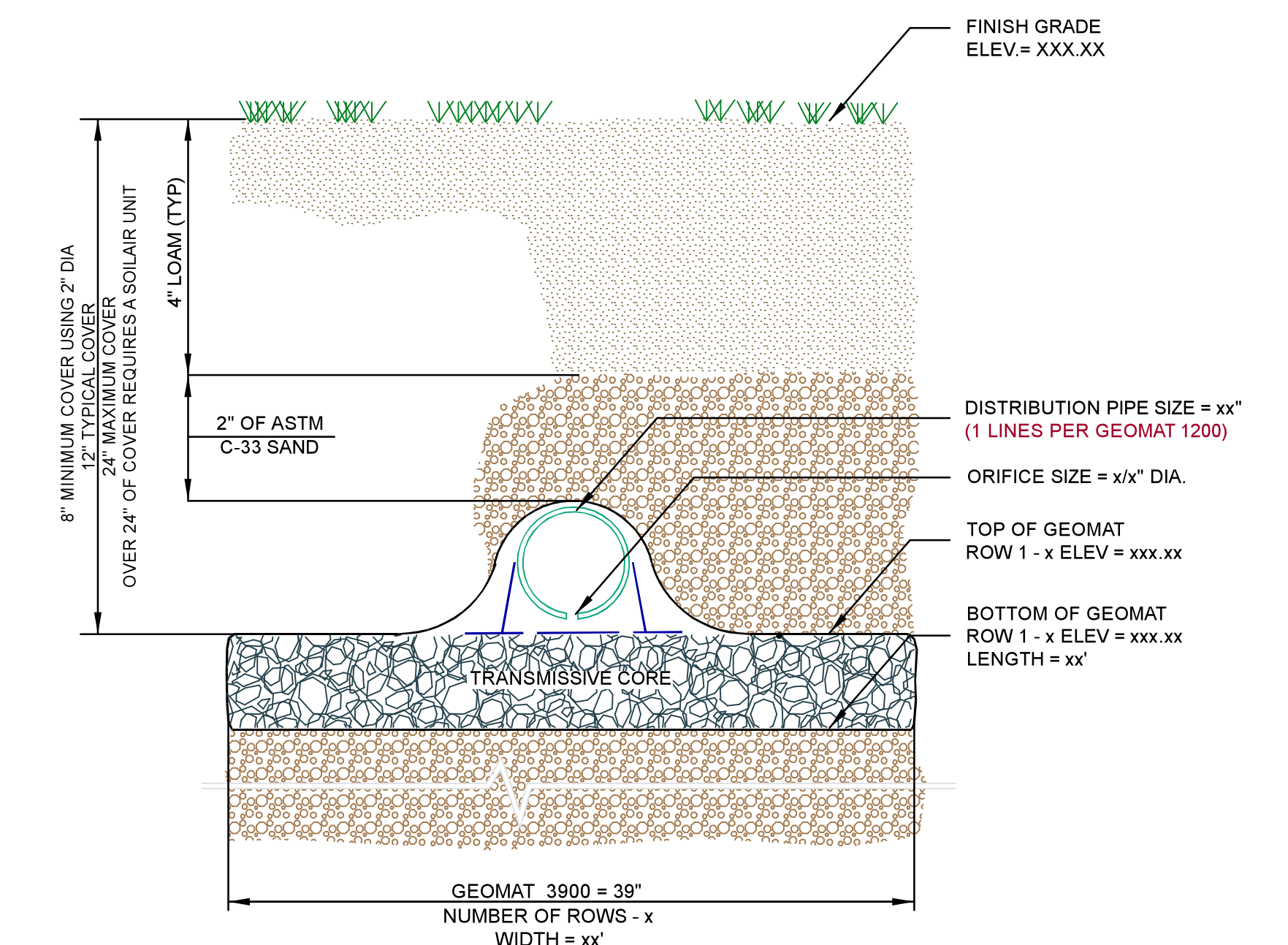

GEOMAT™ 3900 LEACHING SYSTEM PRESSURE DOSED DETAIL WITH LENGTH AND ELEVATIONS
NOT TO SCALE

**OVERVIEW LAYOUT OF ISDS
FOR HOMES 1 - 5
Tax Map 256 Lot 2
BANFIELD ROAD
PORTSMOUTH, NH**

SCALE: 1"=20' DATE: APRIL 22, 2020

OWNER:
WALTER D HETT TRUST

PREPARED FOR:
**PREPARED FOR
GREEN & COMPANY**

g.r.spaulding design consultants, LLC
providing a balance between growth and the environment
PO BOX 248, CANTERBURY, NH 03224
Phone (603) 496-9797
spauldingdesignllc@comcast.net

NEW HAMPSHIRE
Designer
of
Subsurface Disposal
Systems

Gary R. Spaulding
No. 918
Department of Environmental Services



1	05/09/2020	REVISED ST&PC LOCATIONS HOMES 1,2,3	OVL 2 OF 4
REV.	DATE	DESCRIPTION	

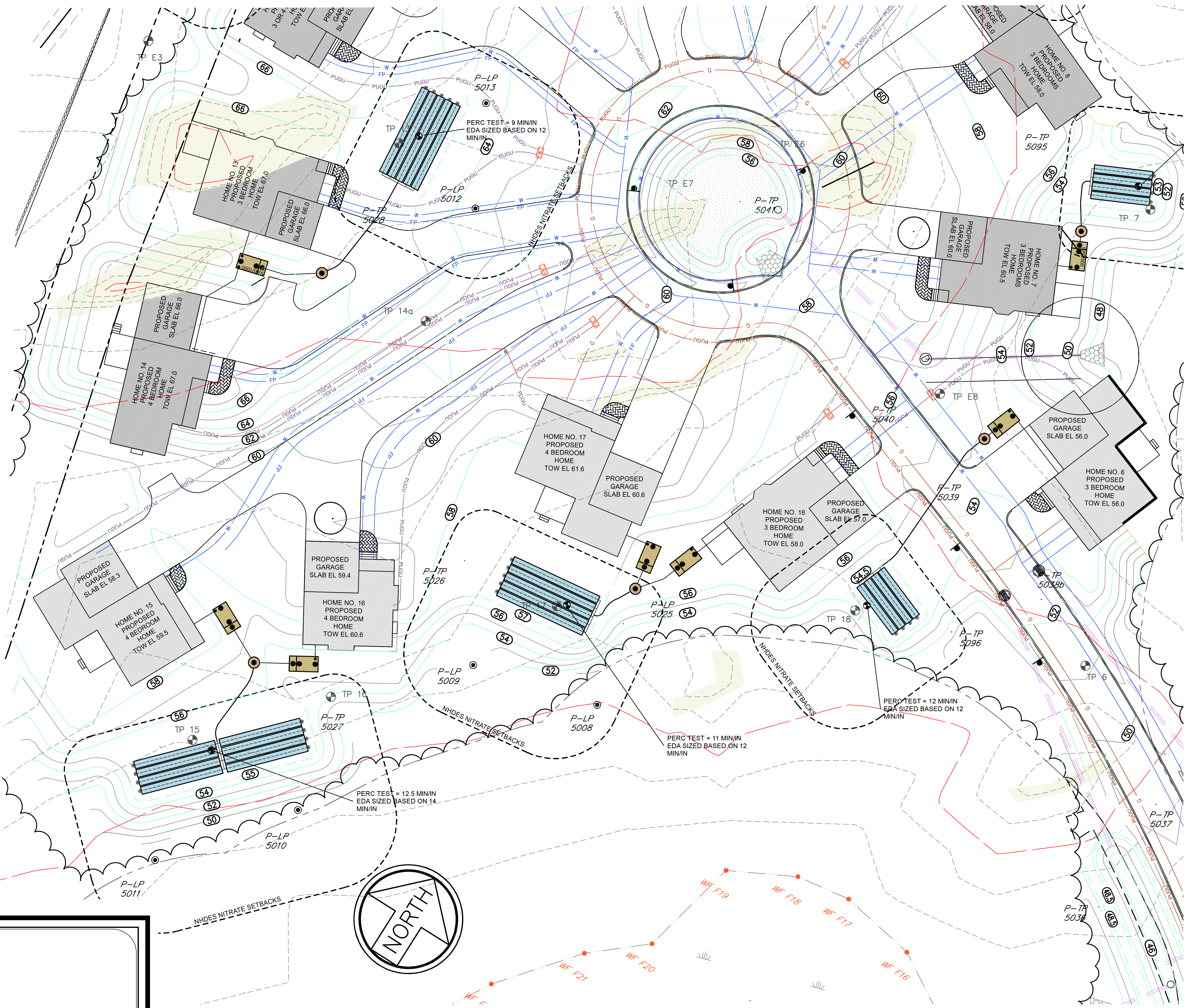

**OVERVIEW LAYOUT OF ISDS
FOR HOMES 6, 13 - 18
Tax Map 256 Lot 2
BANFIELD ROAD
PORTSMOUTH, NH**

SCALE: 1"=20'

DATE: APRIL 22, 2020

OWNER:
WALTER D HETT TRUST

PREPARED FOR:
**PREPARED FOR
GREEN & COMPANY**

g.r.spaulding design consultants, LLC
providing a balance between growth and the environment
PO BOX 248, CANTERBURY, NH 03224
Phone (603) 486-9797
spauldingdesignllc@comcast.net

NEW HAMPSHIRE
Designer
of
Subsurface Disposal
Systems

Gary R. Spaulding
No. 918
Department of Environmental Services

1	DATE	DESCRIPTION	OVL 3 OF 4
---	------	-------------	------------

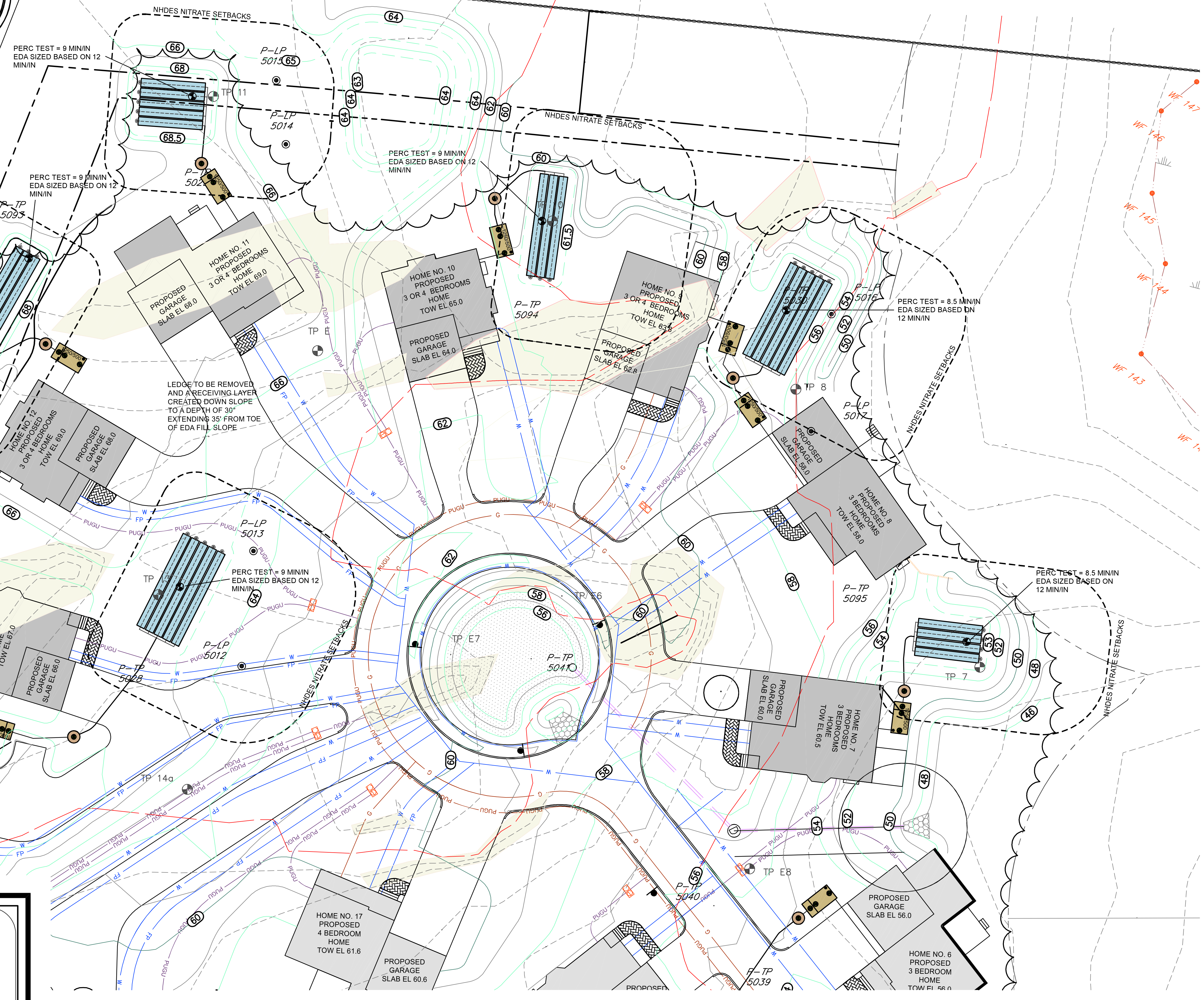
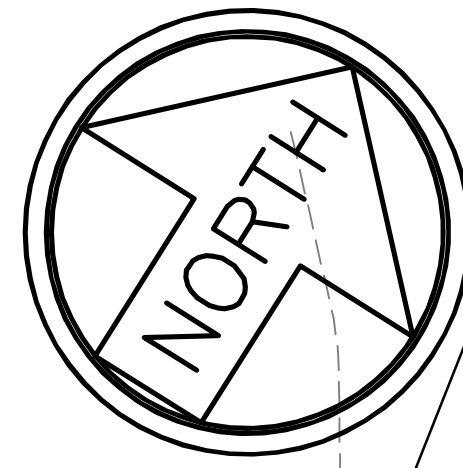

PERC TEST = 9 MIN/IN
EDA SIZED BASED ON 12
MIN/IN

PERC TEST = 9 MIN/IN
EDA SIZED BASED ON 12
MIN/IN

PERC TEST = 8.5 MIN/IN
EDA SIZED BASED ON
12 MIN/IN

PERC TEST = 8.5 MIN/IN
EDA SIZED BASED ON
12 MIN/IN

LEDGE TO BE REMOVED
AND A RECEIVING LAYER
CREATED DOWN SLOPE
TO A DEPTH OF 30"
EXTENDING 35' FROM TOE
OF EDA FILL SLOPE



**OVERVIEW LAYOUT OF ISDS
FOR HOMES 7 - 12
Tax Map 256 Lot 2
BANFIELD ROAD
PORTSMOUTH, NH**

SCALE: 1"=20' DATE: APRIL 22, 2020

OWNER:
WALTER D HETT TRUST

PREPARED FOR:
**PREPARED FOR
GREEN & COMPANY**

NEW HAMPSHIRE
Designer
of
Subsurface Disposal
Systems
★ ★ ★
Gary R. Spaulding
No. 918
Department of Environmental Services

g.r.spaulding design consultants, LLC
providing a balance between growth and the environment
PO BOX 248, CANTERBURY, NH 03224
Phone (603) 496-9797
spauldingdesignllc@comcast.net

1	REV.	DATE	DESCRIPTION

OVL 4 OF 4



May 7, 2020

Juliet Walker, Planning Director
Portsmouth Planning Department
City Hall, 3rd Floor
1 Junkins Avenue
Portsmouth, NH 03801

Re: Proposed Layout and Sizing
Individual Septic System Disposal
The Village of Banfield Woods
Portsmouth NH

Dear Juliet,

The plans provided show the proposed layout of the Individual Septic System Disposal (ISDS) areas for the 22 homes. There are 14 proposed effluent disposal areas (EDA) show on the plan. The EDA's have been sized to handle the wastewater from 1 to 3 homes with each home having 3 to 4 bedrooms. Based on NRCS Soil types for this parcel and using **NHDES Env-Wq 1000 Subdivisions; Individual Sewage Disposal** regulations this parcel could support between 59 and 99 - 3 and 4 bedroom homes based on lot loading calculations. The 22 proposed homes on this parcel will be serviced by Municipal Water.

The proposed septic tanks are two compartment tanks that function more efficiently and increase anaerobic activity which helps breakdown organic solids. The two compartment tanks help retain more suspended solids and allow the use of an effluent filter which extends and improves the efficiency of the systems and increases the longevity of septic systems.

Test Pits have been dug in the location of the EDA's and probes have been dug downslope of the EDA's to show a receiving layer is present that meets NHDES Subsurface Regulations. The Test Pits and Probes were witnessed by the City of Portsmouth Soil Scientist Consultant, Michael Cuomo.



Proposed Layout and Sizing
Individual Septic System Disposal
The Village of Banfield Woods
Portsmouth NH

We also met with Mr. Rob Tardif NHDES Subsurface Bureau Administrator as well as Eric Thomas and Taylor Walter, Subsurface System Reviewer's to go over the test pits and probe results as well as the proposed layout of the effluent disposal areas. During this meeting we discussed the design of the ISDS systems and using the GeoMat leaching system. NHDES staff did not raise any concerns with the proposed layout or the test pits results. NHDES did not see any issues based on the test pits and proposed layout. The only comment, which was a reminder that we would need to provide design plans to NHDES for review and approval prior to construction which we will submit as part of the review process with NHDES.

The location of the proposed EDA's exceeds NHDES setback requirements to wetlands, property line and Nitrate Setback requirements for septic systems under *NHDES Env-WQ 1008.05*. See plan showing Nitrate setback for each system.

NHDES has recognized by regulation that a 50' setback from poorly drained jurisdictional wetlands meets the requirements implemented in RSA485-A:29 -44 to protect water supplies and prevent pollution of surface and groundwater in NH and prevent health hazards.

The effluent disposal areas for this project are a minimum of 100' from the poorly drained jurisdictional wetlands. The increased buffer between the effluent disposal areas and the jurisdictional wetlands results in no wetlands impacts from the proposed EDA's.

We are proposing to use the GeoMat leaching system on this project. The GeoMat system has been independently tested at the Massachusetts Alternative Septic System Test Center as well as meeting NSF testing requirements and being certified by NSF. The GeoMat system has been in use for 15 years and is used in NH, ME, CT, RI, NH, MA, NY, VA, MD, CA, WI, and FL with a track record of superior performance.

The GeoMat™ Leaching System (GeoMat), is low profile and designed for maximum treatment and infiltration of wastewater into soil; in certain instances, it is used for subsurface irrigation and nutrient reuse. GeoMat may be utilized with wastewater from a septic tank or alternative pretreatment systems. The GeoMat



g.r.spaulding design consultants, LLC
providing a balance between growth and the environment

Proposed Layout and Sizing
Individual Septic System Disposal
The Village of Banfield Woods
Portsmouth NH

3900 is being proposed at The Village of Banfield Woods. The GeoMat 3900 is 39 inches wide.

Effluent flows into the GeoMat through gravity or a pressure piping system. The water is discharged into a highly transmissive core that is covered by a hygroscopic membrane. This combination of the core and membrane draw the water between the application points and uniformly apply the water to the surrounding soil. The soil then draws the water away from the surrounding membrane through capillary action. This results in a much more uniform application of water to the soil and minimizes the point loading associated with other septic systems. GeoMat with 6 inches of ASTM C-33 sand beneath it meets NSF Standard 40 testing requirements.

The combination of a high surface area to void space ratio and shallow placement in the soil profile result in enhanced aeration. Shallow placement in the more biologically active soil horizons additionally enhances treatment of nitrogen, phosphorus, pharmaceutical compounds and other emerging contaminants of concern, Biological Oxygen Demand (BOD), Total Suspended Solids (TSS), viruses and other pathogens providing better overall performance than typical systems.

In summary, the proposed GeoMat system provide enhanced wastewater effluent treatment, exceed the setback distance to wetlands by over two times the required setback, and distributes effluent more evenly throughout the system providing a higher effluent to soil surface treatment ratio over conventional septic systems. The applicant has agreed to use the GeoMat system in an effort to minimize environmental impact and enhance treatment.

If you have questions, please feel free to contact me by phone 603-496-9797 or by email spauldingdesignllc@comcast.net

Regards,

Gary Spaulding
g.r.spaulding design consultants LLC

THE VILLAGE OF BANFIELD WOODS - LOT LOADING CALCULATIONS

		AC	sq.ft
Total Parcel Size		44.88	1954973
Wetlands Area on Parcel		18.97	826333

SOIL TYPE ON PARCEL	NHDES SOILS GROUP	NHDES SOILS FACTOR	NOTES
140B & C	3	1.6	* depth to ledge requires using NHDES Group 4 soil
538A	5	3	

NHDES Allowable Lot Loading per Env-Wq 1005.05 Open Space / Conservation Subdivisions

SOIL TYPE	SOIL AREA	TOTAL AREA BY SOIL TYPE (SQ.FT)	TOTAL AREA BY SOIL TYPE (AC)	NHDES SOILS FACTORS	NHDES SOILS FACTOR GROUP 4	NHDES GPD PERMITTED for PROPERTY BASED ON SOILS GROUPING **
140B	35433	10205	23.17	1.6	1.45	28959
140C	118851		2.73	1.76	1.6	3101
538A	826970		18.98	3	0	12656
		TOTAL	44.88	TOTAL	TOTAL	44716
TOTAL NUMBER OF BEDROOMS ALLOWED ON THIS PARCEL						
TOTAL NUMBER OF 3 BEDROOM HOMES ALLOWED ON THIS PARCEL						
TOTAL NUMBER OF 4 BEDROOM HOMES ALLOWED ON THIS PARCEL						
PROPOSED NUMBER OF HOME PROPOSED ON THIS PARCEL						

LOT LOADING CALCULATIONS BASED ON NHDES RULE: Env-Wq 1005.03 Minimum Lot Sizes (K)

** **Q (gpd) = SOIL AREA (AC) x 2000 gpd/ac / Soils Loading Factor**

gpd - gallons per day

AC - acres

Soils Factor - from Table 1005-1 (NHDES Subdivision Regulations)

Parks Canada

[Home](#) → [National Parks](#) → [Bruce Peninsula National Park](#) → [About](#) → [On the Road to Recovery](#)
→ New ecopassages



Bruce Peninsula National Park



New ecopassages to help critters cross the road

Wildlife is benefitting from the installation of ecopassages at Bruce Peninsula National Park.

Eco-passages are specialized wildlife tunnels which allow animals to safely cross busy roads. They are especially important in areas where a road fragments critical habitat and prevents animals from reaching their breeding grounds.

Our scientists have identified seven high priority locations for ecopassages in Bruce Peninsula National Park. These are areas where we've traditionally seen a high number of road deaths or injuries to reptiles and amphibians because of cars, also known as "hotspots".

Animals which try to cross the road in these areas will encounter a specialized fence. Snakes, turtles and small mammals such as rodents are not able to crawl over, or dig under these fences. Instead they are redirected to a tunnel. These tunnels are specially designed to be more attractive to reptiles and amphibians by allowing sunlight through the top so these cold blooded creatures (ectotherms) don't have to go into cold, dark places to get where they are going.

We continue to monitor how well this system works, and so far, results are positive. We have already photographed many different animals using these tunnels and have made improvements to the original design we started using in 2012. We are confident we are on the right path to help at risk species such as snapping turtle, massasauga rattlesnake, eastern ribbon snake and several others.



The fencing leads animals to the opening and each end of the ecopassage.

Next time you visit us at Bruce Peninsula National Park watch for the metal grates on the roads. Those are your sign that we're working hard to help protect the creatures which share this



magnificent place with us.

Specialized fence to direct animals towards the ecopassages



Date modified :

2019-05-18

**Rendering of Ecopassage at The Village at
Banfield Woods**

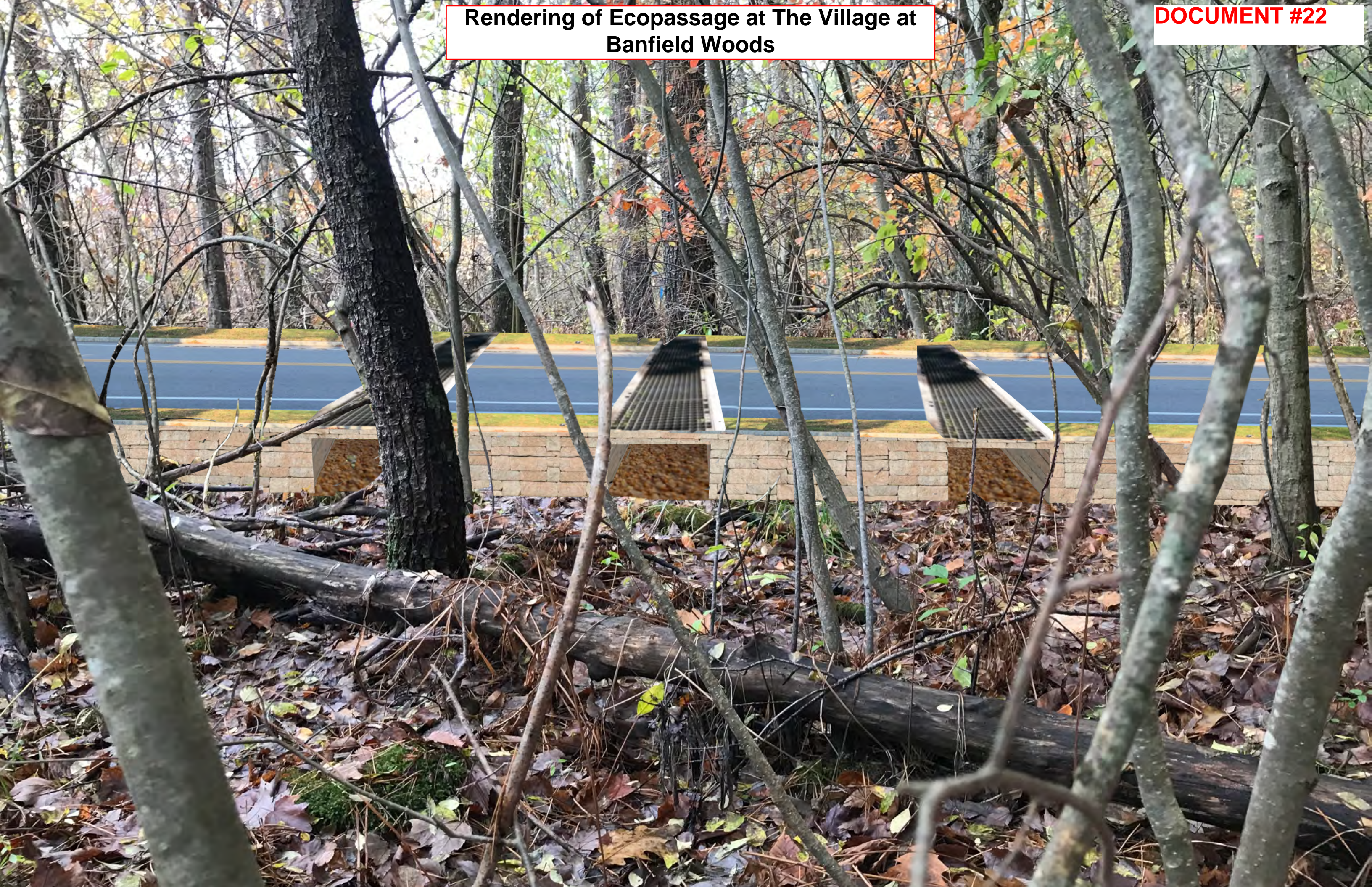

The Village at Banfield Woods Wildlife Impact Assessment



Prepared For:
Green and Company
11 Lafayette Rd.
PO Box 1297
North Hampton, NH 03862

Submitted On:
April 27, 2020
Edited
May 5, 2020

Prepared By:
Normandeau Associates, Inc.
25 Nashua Road
Bedford, NH 03110

www.normandeau.com

Table of Contents

	Page
EXECUTIVE SUMMARY	2
INTRODUCTION	2
SITE DESCRIPTION	3
IMPACTS OF DEVELOPMENT ON WILDLIFE.....	4
BEST MANAGEMENT PRACTICES	5
LITERATURE CITED.....	9

Executive Summary

Normandeau Associates Inc. (Normandeau) was contracted by Green and Company to conduct an independent review of the wildlife impact of a proposed residential development, The Village at Banfield Woods (Project), located at 0 Banfield Rd., Portsmouth, New Hampshire. The Village at Banfield Woods is located on a 44.8-acre parcel with approximately seven acres of development with 22 single family dwellings, access roads, and septic systems.

In order to determine the impacts of the Project on wildlife, Normandeau reviewed the relevant Project documents including the Site Plan (Figure 1), Landscape Plan (Figure 2), and relevant correspondence (Appendix 1). A Normandeau biologist conducted a site visit to gain a better understand of the project area and reviewed the relevant literature and regulations. Based on this work, we present this document as an independent assessment of the impact of the Project on wildlife.

To date, the Project has taken considerable measures to avoid and minimize impacts to wildlife by consolidating the Project foot print, avoiding wetlands, lowering the roadway, maintaining 100-foot wetland buffers, installing three ecopassages with open top grates, and extensive landscaping with native trees and shrubs. The permanent protection by deed restriction on 11 acres of the Project further mitigates some of the unavoidable impacts to wildlife.

While the project has taken these substantial measures to avoid impacts to wildlife, some loss of individuals and habitat will likely occur. However, given the extent of available habitat outside of the Project, it is not likely that this Project will impact any species on a population level. Green has agreed to additional measures to more fully meet the objectives of *Practice 7 - Maintain or replace natural features and functions within developed areas*, including habitat management in the areas to be protected under deed restrictions. These measures consist of creating brush piles with the removed trees, installation of nesting boxes for birds and bats, and donating an additional portion of the remaining acreage to conservation.

Additionally, construction crews should be made aware of the priority of protecting wildlife and conduct visual surveys prior to ground work to avoid injury to wildlife during construction.

Introduction

As with all development of natural lands, some impacts to wildlife are unavoidable, however the use of best management practices aid in avoiding and minimizing these impacts and mitigation measures may offset many, thereby reducing the overall impacts to wildlife.

In order to determine the impacts of the Project on wildlife, Normandeau reviewed the relevant Project documents and the memorandum from Peter Britz, Environmental Planner at the Portsmouth Planning Department, to the City of Portsmouth Conservation Commission

Members dated December 10, 2019. We also reviewed the correspondence between West Environmental Inc. and Mr. Britz dated January 28, 2020, and Gove Environmental Services, Inc.'s response to Mr. Britz dated February 28, 2020.

A Normandeau wildlife biologist conducted a site visit on April 15, 2020. These observations in combination with review of project documents allowed Normandeau to assess potential wildlife impacts, and make recommendations for mitigative measures.

Site Description

The Project lies on the north side of Banfield Road, and consists of a mixture of upland and wetland. The Project area is mapped as part of a 900-acre wetland upland complex (the Great Bog), much of which is protected land. The Great Bog is predominantly emergent and shrub wetland, and contains several sensitive natural wetland communities: herbaceous seepage marshes, and red maple- sensitive fern swamp, as well as a range of upland habitats. A smaller remnant Atlantic white cedar – yellow birch – pepperbush swamp (Packer Bog) lies several miles to the south outside of the Project area.

The 44.8-acre project parcel is mapped on the NH WAP as mostly Appalachian oak-pine forest with smaller areas of northern or temperate swamp, and marsh and shrub wetlands (Freshwater Forested/Shrub Wetland; USFWS 1979 classification codes: PFO1C, PSS1C, and PFO1/4C; Cowardin et al., 1979) (NHFG, 2015). Red oak (*Quercus rubra*) and American beech (*Fagus grandifolia*) (~4-12" DBH) are dominant in the parcel west of the transmission right-of-way (ROW), and white pine (*Pinus strobus*) (up to ~24") are more prominent in the building envelope areas with some black cherry (*Prunus serotina*) (~4-8"). All upland areas had sparse to no understory, which includes some sapling beech and pine, partridge berry (*Mitchella repens*), and what would likely open up to be false-lily of the valley (*Maianthemum dilatatum*) and star flower (*Trientalis borealis*). Red maple and high bush blueberry (*Vaccinium corymbosum*) were present in the wetland areas. The understory in wetland areas was too premature for species identification, but evidence from last year suggests cinnamon and/or interrupted fern (*Osmunda cinnamomea*; *O. claytoniana*), skunk cabbage (*Symplocarpus foetidus*), and sedges (Cyperaceae Family). Little standing water was present in wetland areas despite heavy rain within the last week, limiting amphibian breeding to two possible locations. These areas were mapped as wetland but no vernal pools are noted on the site plan. Snags are present throughout entire parcel and provide potential habitat for a number of species. Numerous rock walls and ledges as well as grade differences are located across the site. White-tailed deer (*Odocoileus virginianus*) sign was observed in several locations west of the powerline ROW, and occasionally on east, with two game trails, likely deer, observed as well. Transmission lines typically provide good travel corridors for wildlife, but the one bisecting the parcel showed little evidence of use. It is densely vegetated with cattail (*Typha latifolia*) and invasive common reed (*Phragmites australis*),

which may discourage use by some species. The transmission line ROW at the northern end of parcel does provide good travel corridor and a game trail was observed here.

The following wildlife species or signs of species were observed during the site visit (Figure 3 and Figure 4 with corresponding photographs in Appendix 2):

- White-tailed deer (*Odocoileus virginianus*) (Scat/sign)
- Common garter snake (*Thamnophis sirtalis*)
- Red-bellied woodpecker (*Melanerpes carolinus*)
- Eastern wild turkey (*Meleagris gallopavo silvestris*)
- Palm warbler (*Setophaga palmarum*)
- White breasted nuthatch (*Sitta carolinensis*)
- American robin (*Turdus migratorius*)
- Brown creeper (*Certhia Americana*)
- Tufted titmouse (*Baeolophus bicolor*)
- Black-capped chickadee (*Poecile atricapillus*)
- Gray squirrel (*Sciurus carolinensis*)
- Owl (pellet)
- Raccoon (*Procyon lotor*) (Scat)
- Unknown canine scat

No rare, threatened or endangered species were observed. A review of the U. S. Fish and Wildlife Information for Planning and Consultation (IPaC) tool indicated that only Northern long-eared bat (*Myotis septentrionalis*), which is listed as threatened under the Federal Endangered Species Act, and is listed as endangered under the New Hampshire Endangered Species Conservation Act range extends to the Project area. However, the New Hampshire Natural Heritage Bureau Review did not indicate any rare wildlife species were located near the Project area nor were any rare Natural Communities located in the Project area.

Impacts of development on wildlife

Development is known to have direct impacts to wildlife habitat through the removal of native vegetation and fragmentation, which can have nontrivial consequences to wildlife (e.g. Theobald et al., 1997; Fischer and Lindenmayer, 2007). Indirect impacts to wildlife can be caused by seemingly benign activities such as installation of fencing that can restrict movement, landscaping with non-native vegetation that can decrease food availability, and human activities that can induce avoidance behaviors (Gabrielson and Smith, 1995; Whitcomb et al., 1981). The full impact of development on wildlife is poorly understood and it is difficult to determine the cumulative impacts of development to wildlife communities as the individual species response is so variable (Theobald et al., 1997). Two components of development that are critical to understanding the impact of development on wildlife are the density and pattern of

the site design (Theobald et al., 1997). The interaction between these two elements can have a major impact on the zones of wildlife disturbance and the degree of habitat fragmentation (Theobald et al., 1997). The type of habitat being developed is also an important consideration. According to the New Hampshire Department of Environmental Service (NHDES), important habitats for wildlife include lands inhabited by threatened or endangered species, un-fragmented lands, riparian areas, priority wetlands, open lands, connecting lands, and unique or critical habitat (NHDES, 2004a). In order to avoid and minimize these impacts, the Project has taken measures outlined below to minimize impacts to wildlife using Best Management Practices and to mitigate some of the unavoidable impacts by protecting lands via conservation easement and undergoing activities to improve wildlife habitat.

Best Management Practices

Best management practices during construction and preservation of corridors linking habitat patches can assist in avoiding and reducing these impacts and open-space set-asides and habitat improvement may be effective mitigation measures (Soulé, 2007). In order to minimize the impact of development to wildlife, the NHDES has identified seven habitat-sensitive site design and development practices that are outlined below (NHDES, 2004b).

- *Practice 1 - Applicants should review the habitat conservation goals cited in local and regional plans and manuals on habitat identification and protection.*
 - City of Portsmouth, NH Zoning Ordinance Article 10 Section 10.1017.50
- *Practice 2 - Apply principles of conservation design to minimize impacts and preserve natural undeveloped lands.*
- *Practice 3 - Preserve large and contiguous blocks of natural, undisturbed vegetation, looking for opportunities to connect to undeveloped lands on adjacent parcels.*
- *Practice 4 - Conserve rare and outstanding landscape elements, such as unique features or habitats, by directing development to other areas. These include:*
 - Salt marshes
 - Riparian areas
 - Vernal pools
 - Enriched forest
 - Large wetland complexes
- *Practice 5 - Identify and conserve wildlife corridors through the property to facilitate wildlife movement across developed areas.*
- *Practice 6 - Maintain significant buffers of undeveloped land between important habitat areas and developed areas. These include:*
 - Habitat of Rare Wildlife Species
 - Un-fragmented Lands
 - Riparian Areas and Shorelines
 - Priority Wetlands

- *Agricultural and Other Open Lands*
- *Other Unique or Critical Habitats*
- *Connective Lands*
- *Practice 7 - Maintain or replace natural features and functions within developed areas.*
 - *Capture and infiltrate rainwater on-site*
 - *Maintain the structure and function of aquatic systems*
 - *Use native vegetation for landscaping*
 - *Minimize clearing, grading, and compaction of soil*
 - *De-compact remaining open soil after construction and add top-soil*

The following discussion presents how the Project meets the seven BMPS.

Practice 1 - Applicants should review the habitat conservation goals cited in local and regional plans and manuals on habitat identification and protection

In order to satisfy the NHDES best management a review of all relevant and publicly available information pertaining to wildlife in and around the Project area was conducted. Only one federal listed wildlife species was identified as potentially being located in the project area. The WAP maps (Figures 5) provide additional context and information on surrounding habitats.

Practice 2 - Apply principles of conservation design to minimize impacts and preserve natural undeveloped lands.

The Project has consolidated the developed areas into two sections which are in close proximity to each other. Ideally, these two sections would be combined, however given the Project's desire to avoid impacts to wetlands including maintaining a 100-foot buffer, this is not possible. Additionally, the project has committed to other conservation design elements such as lowering the road way, ecopassages, extensive landscape plan, reduced street lighting and the removal of guard rails where safe to do so reducing impacts to wildlife movement.

Practice 3 - Preserve large and contiguous blocks of natural, undisturbed vegetation, looking for opportunities to connect to undeveloped lands on adjacent parcels.

The Project parcel is part of a large tract of mostly-intact natural lands. While this project will result in an intrusion into the tract, the proposed developed area of the Project represents a small portion of this area and is on the periphery of the tract. In order to mitigate these impacts, the project will be placing deed restrictions on over 11 acres of "common open Space" (Figure 1), protecting it in perpetuity. The Project has expressed willingness to donate additional acreage to conservation which would further mitigate impacts to wildlife.

Practice 4 - Conserve rare and outstanding landscape elements, such as unique features or habitats, by directing development to other areas

The Project has consolidated the developed areas to the extent possible, and maintained the wetland buffers, minimizing the degree of habitat fragmentation and conserving over 80% of the site in its natural state.

Practice 5 - Identify and conserve wildlife corridors through the property to facilitate wildlife movement across developed areas

The Project contracted Gove Environmental Services, Inc. to conduct a study of wildlife corridors which are indicated on the “Upland Wetland Habitat Map” (Figure 6). Given the number of corridors available for wildlife, it is unlikely that the project will greatly impact the movement of larger species across the project. In order to minimize the impact of the access road on wildlife movement, the project has taken multiple steps including minimizing the number of retaining walls, and the design of three ecopassages, improving wildlife access through those areas.

Practice 6 - Maintain significant buffers of undeveloped land between important habitat areas and developed areas.

With the exception of a narrow (less than 100') wetland crossing to access the site, the project is maintaining a 100-foot buffer from all other wetland areas. Maintaining this buffer is a substantial compromise for the project, greatly reducing the amount of acreage available for development. Maintaining this buffer will substantially minimize the impact of the project on wetland habitats and wildlife that may be using these areas.

Practice 7 - Maintain or replace natural features and functions within developed areas.

Impacts to wetland functions have been minimized by maintaining a 100-foot protective buffer around the entire development with the unavoidable exception of the access road. Impacts to likely travel corridors for amphibian and reptiles and other small wildlife have been mitigated by the use of three appropriately sized eco-passages under the access road. The retaining walls used to minimize wetland impacts have been reduced to less than 3 feet which will not impede most larger wildlife species. Additionally, the Project has committed to re-vegetating areas where tree removal is necessary with native New England vegetation where feasible (Figure 2).

Response to the City of Portsmouth’s Concerns

The following discussion addresses Mr. Britz’s concerns state in the memo dated December 10, 2019, Mr. Britz noted that the applicant was not satisfying the conditions from the City of

Portsmouth, NH Zoning Ordinance Article 10 Section 10.1017.50, regarding the impacts of the project on wildlife. Mr. Britz noted that under the condition “*The land is reasonably suited to the use activity or alteration*”, that the land is not suited to alteration, in part, because the land is part of a large wetlands complex with significant wildlife movement. Additionally, under the condition that the applicant demonstrated that “*There will be no adverse impact on the wetland functional values of the site or surrounding properties*”, Mr. Britz believed that the impacts to wildlife were severe enough that this condition was not met. Mr. Britz listed the following concerns:

- **Wildlife Habitat Impacts.** Mr. Britz expressed concern that the Project was impacting supporting landscapes (from the NH WAP) and will fragment a large tract of land including the Great Bog and NH Fish and Game land, including habitat in all three categories from the NH WAP. In order to determine the relative condition of potential wildlife habitat in the state of New Hampshire, the NH WAP analyzed numerous data sets including biological, landscape, and human influence factors, to rank priority wildlife habitat into three categories. These include *Highest ranked in the State* which are the top 15% by area of each habitat and especially rare habitats. *Highest ranked in the Biological Region* which include the top 30% of each habitat except those included in the *Highest ranked in the state*, and some priority natural communities as ranked by the NH Natural Heritage Bureau. *Supporting landscapes* includes the remainder of the top 50% of each habitat plus some large intact forest blocks (NHFG, 2015). Approximately four acres of the project development area is located within areas identified as “*Supporting Landscapes*” from the NH WAP (Figure 3); the remainder was not included as mapped habitat. It is likely that the Project area was included due to its being part of a larger forested tract that is adjacent to the Great Bog, portions of which are mapped as *Highest ranked in the State* (Figure 5). The Project parcel is part of a 900-acre tract of mostly-intact land that includes areas with all three habitat rankings. While this project will result in an intrusion into the periphery of the Great Bog tract, the proposed developed area of the Project represents less than 1% of the total area and is near the edge of the tract, thereby reducing fragmentation impacts.
- **Wildlife Movement.** Mr. Britz was also concerned that the proposed access road will permanently impact wildlife movement. One retaining wall is necessary to avoid impacting the wetland buffer zone: this wall may inhibit the movement of small animals. In order to reduce this impact, three ecopassages, of the best available design, were included to facilitate the movement of small animals. These ecopassages are of a sufficient size for most small animals to utilize and three passages are included in the design, which is more than sufficient given the length of the retaining wall. Gove Environmental Services Inc. identified multiple wildlife corridors both within the project area and outside of the parcel (Figure 6). The unavoidable wetland crossing

from Banfield Rd. into the Project Parcel is made at the narrowest point, minimizing impacts. It is unlikely that the project will greatly impact the movement of larger species and the project has taken substantial precautions to minimize the impacts to smaller species.

- Wetland Functional Impact.** While addressing the condition that *“The land is reasonably suited to the use activity or alteration”*, Mr. Britz stated the land is not suited to alteration, in part, because the land is part of a large wetlands complex with significant wildlife movement. Additionally, under the condition that the applicant demonstrated that *“There will be no adverse impact on the wetland functional values of the site or surrounding properties”*, Mr. Britz believed that the Project poses adverse impacts to wildlife habitat and that a principal function of the wetlands on the site are to provide wildlife habitat. The project has minimized impacts to wetland areas, to the extent possible, by avoiding development of the wetland areas, with the exception of where the access road intersects Banfield Road. This small section of wetlands is already not ideal wildlife habitat given the proximity of the existing road way and is the least impactful access to the parcel from Banfield Road.

It has been brought to Normandeau’s attention that the City Staff had a question of concern over the density of this development and thought any environmental impact would be reduced by removing 1-2 units. Green inquired of Normandeau how decreasing the development from 22 to 20 units would impact the wildlife. We believe since there would be no change in the amount of land developed, no change to the roads or infrastructure being constructed, and no changes in the already minimal wetland or wetland buffer impacts on the site by altering unit density, the impacts of the Project on wildlife would remain relatively unchanged.

Literature Cited

- Cowardin, L. M., and F. C. Golet. 1995. U. S. Fish and Wildlife Service 1979 wetland classification: A review. *Vegetation* 118: 139.
- Fischer, J. and D. B. Lindenmayer. 2007. Landscape modification and habitat fragmentation: a synthesis. *Global Ecology and Biogeography*, 16:265–280.
- Gabrielson, G.W., Smith, E.N., 1995. Physiological responses of wildlife to disturbance. In: *Wildlife and Recreationists*. Knight, R.L., and K. J. Gutzwiller (Eds.). Island Press, Washington, DC, pp. 95-107.

- New Hampshire Department of Environmental Services (NHDES). 2004a. Environmental fact sheet: Minimizing the impact of development on wildlife: Actions for local municipalities (ID-5). Concord, New Hampshire.
- New Hampshire Department of Environmental Services (NHDES). 2004a. Environmental fact sheet: Habitat-sensitive site design and development practices to minimize the impact of development of wildlife (ID-4). Concord, New Hampshire.
- New Hampshire Fish and Game (NHFG). 2015. New Hampshire Wildlife Action Plan. Concord, New Hampshire.
- Soulé, M. E. 1991. Land use planning and wildlife maintenance: Guidelines for conserving wildlife in an urban landscape. *Journal of the American Planning Association*, 57: 3.
- Theobald, D. M., J. R. Miller, and N. T. Hobbs. 1997. Estimating the cumulative effects of development on wildlife habitat. *Landscape and Urban Planning*, 39: 25–36.
- Whitcomb, R., C. Robbins, J. Lynch, B. Whitcomb, M. Klimkiewicz, and D. Bystrak. 1981. Effects of forest fragmentation of avifauna of the eastern deciduous forest. In: *Forest Island Dynamics in Man Dominated Landscapes*. Burgess, R.L., and D. M. Sharpe (Eds.). Springer, New York.

Figure 1 Banfield Road Site Plan

CITY OF PORTSMOUTH PLANNING BOARD

CHAIRPERSON DATE

Table with columns: LINE, BEARING, DISTANCE. Lists boundary measurements for the site.

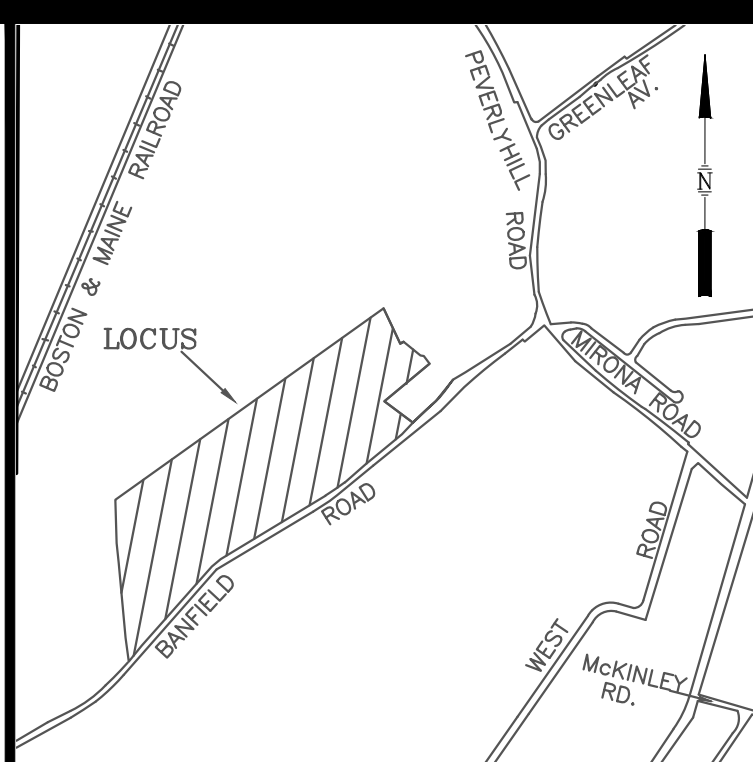

LOCATION PLAN

NOTES:

- 1. THE PARCEL IS LOCATED IN THE SINGLE RESIDENCE A (SRA) ZONING DISTRICT.
2. THE PARCEL IS SHOWN ON THE CITY OF PORTSMOUTH ASSESSOR'S MAP 256 AS LOT 2.
3. THE PARCEL IS LOCATED IN ZONE X AS SHOWN ON NATIONAL FLOOD INSURANCE PROGRAM (NFIP)...

PLAN REFERENCES:

- 1. "SUBDIVISION PLAN FOR WALTER D. HETT & THE TEMPLE OF ISRAEL BANFIELD ROAD COUNTY OF ROCKINGHAM PORTSMOUTH, NH..."
2. "PROPERTY OF SWIFTWATER GIRL SCOUT COUNCIL, CITY OF PORTSMOUTH"...

I HEREBY CERTIFY THAT THIS PLAN IS ACCURATE AND COMPLIES WITH NHRSA 356-B:20(1). ALL UNITS OR PORTIONS THEREOF DEPICTED ON ANY PORTION OF THE SUBMITTED LAND OTHER THAN WITHIN THE BOUNDARIES OF ANY CONVERTIBLE LAND HAVE NOT YET BEGUN.

I CERTIFY THAT THIS SURVEY AND PLAN WERE PREPARED BY ME OR BY THOSE UNDER MY DIRECT SUPERVISION. THIS SURVEY IS AN URBAN SURVEY AS CLASSIFIED IN THE NH CODE OF ADMINISTRATIVE RULES OF THE BOARD OF LICENSURE FOR LAND SURVEYORS...

LEGEND:

Legend defining symbols for Assessor's Map Number/Lot Number, Natural Resource Protection, Property Line, Pavement, Wetlands, Common Open Space, etc.

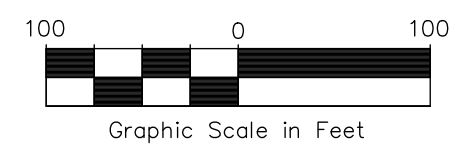

Table with columns: REV, DATE, DESCRIPTION, ID, BMK, DR, CK. Revision history for the plan.



CONTACT DIG SAFE 72 BUSINESS HOURS PRIOR TO CONSTRUCTION

LIMITED COMMON AREA table listing LCA numbers and square footages.

MAP 256 LOT 1 N/F SWIFT WATER GIRL SCOUT COUNCIL ONE COMMERCE DRIVE BEDFORD, NH 03110...

Vertical text on the left margin: Mar 23, 2020 - 4:17pm F:\MSC Projects\47261 - Banfield Road - Portsmouth\47261-100 - Green & Co - Banfield Road\Carlson Survey\Drawgs\47261-100 Survey.dwg

Copyright 2020 © Thomas F. Moran, Inc. All rights reserved. These plans and materials may not be copied, duplicated, replicated or otherwise reproduced in any form whatsoever without the prior written permission of Thomas F. Moran, Inc.

TAX MAP 256 LOT 2 CONDOMINIUM SITE PLAN BANFIELD ROAD PORTSMOUTH, NEW HAMPSHIRE COUNTY OF ROCKINGHAM OWNED BY THE WALTER D. HETT TRUST PREPARED FOR GREEN & COMPANY REAL ESTATE

Professional information for TFM and MSC, including contact details and license numbers.

Figure 2 Banfield Road Landscape Plan

LEGEND	
PROPOSED	
	LARGE DECIDUOUS SHRUBS
	SMALL DECIDUOUS SHRUBS
	LARGE EVERGREEN SHRUBS
	SMALL EVERGREEN SHRUBS
	EVERGREEN TREE
	ORNAMENTAL DECIDUOUS TREE
	MAJOR DECIDUOUS TREE

NOTE:
SELECTED LANDSCAPE PLANT SPECIES TO BE
NATIVE OR APPROVED NATIVE TO NEW ENGLAND.



HORIZONTAL SCALE 1"=30'
30 15 0 30

SITE DEVELOPMENT PLANS
 TAX MAP 256 LOT 2
PRELIMINARY LANDSCAPE PLAN
THE VILLAGE AT BANFIELD WOODS
 PORTSMOUTH, NH
 OWNED BY
WALTER D HETT TRUST
 PREPARED FOR
GREEN & COMPANY REAL ESTATE
 SCALE: 1"=30' SEPTEMBER 25, 2019

TFM Civil Engineers
 Structural Engineers
 Traffic Engineers
 Land Surveyors
 Landscape Architects
 Scientists

48 Constitution Drive
 Bedford, NH 03110
 Phone (603) 472-4488
 Fax (603) 472-9747
 www.tforman.com

47361.00 DR RCK FB
 OK JAM CADFILE LANDSCAPE LANDSCAPE

Dec 03, 2019 - 8:47am
 F:\MSDC\Projects\47361 - Banfield Woods - Portsmouth\47361-001 - Green & Co - Banfield Road\Design\Production Drawings\landscape.dwg

Copyright 2019 © Thomas F. Moran, Inc.
 48 Constitution Drive, Bedford, N.H. 03110
 All rights reserved. These plans and materials may not be copied,
 duplicated, republished, or otherwise reproduced in any form whatsoever
 without the prior written permission of Thomas F. Moran, Inc.
 This plan is not effective unless signed by a duly authorized officer of
 Thomas F. Moran, Inc.

BANFIELD ROAD

**Figure 3 Photographic Map and New Hampshire Wildlife Action Plan
Habitat Ranking**

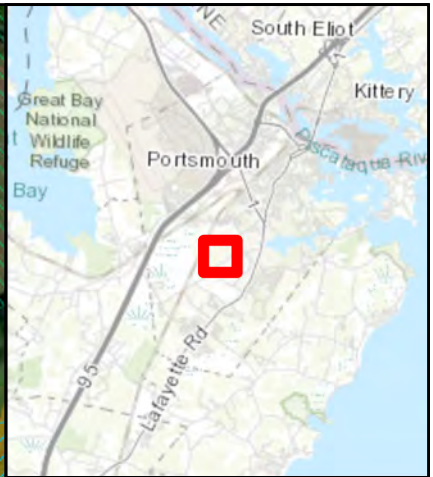

Project 24450.00
Green and Company
Wildlife Impact Review
 Portsmouth, NH

- Photo location points
- Parcel boundary
- Delineated wetland line
- Development envelope
- Conservation land
- Prime wetlands
- WAP Tier 1: Highest Ranked Habitat in New Hampshire
- WAP Tier 2: Highest Ranked Habitat in Biological Region
- WAP Tier 3: Supporting Landscapes



0 125 250 500 Feet



Figure 4 Wildlife Sign Map

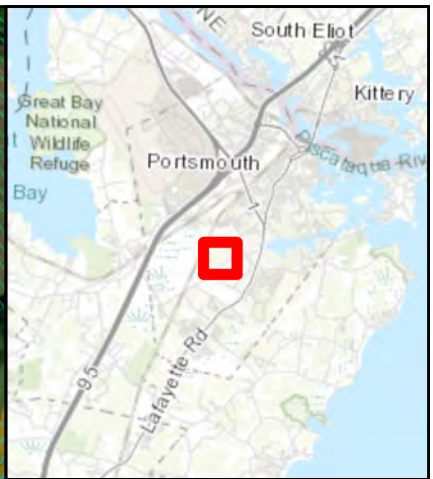

Project 24450.00
Green and Company
Wildlife Impact Review
 Portsmouth, NH

- Wildlife points
- Parcel boundary
- Delineated wetland line
- Development envelope
- Conservation land
- Prime wetlands
- WAP Tier 1: Highest Ranked Habitat in New Hampshire
- WAP Tier 2: Highest Ranked Habitat in Biological Region
- WAP Tier 3: Supporting Landscapes

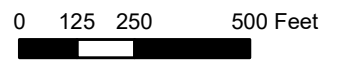

Figure 5 Town of Portsmouth Wildlife Action Plan Habitat Rankings

2015 HIGHEST RANKED WILDLIFE HABITAT BY ECOLOGICAL CONDITION

 Highest Ranked Habitat in New Hampshire

 Highest Ranked Habitat in the Biological Region

Biological region = TNC ecoregional subsection for terrestrial habitats or Aquatic Resource Mitigation region for wetlands and floodplain forest.

 Supporting Landscapes

 Conservation or public

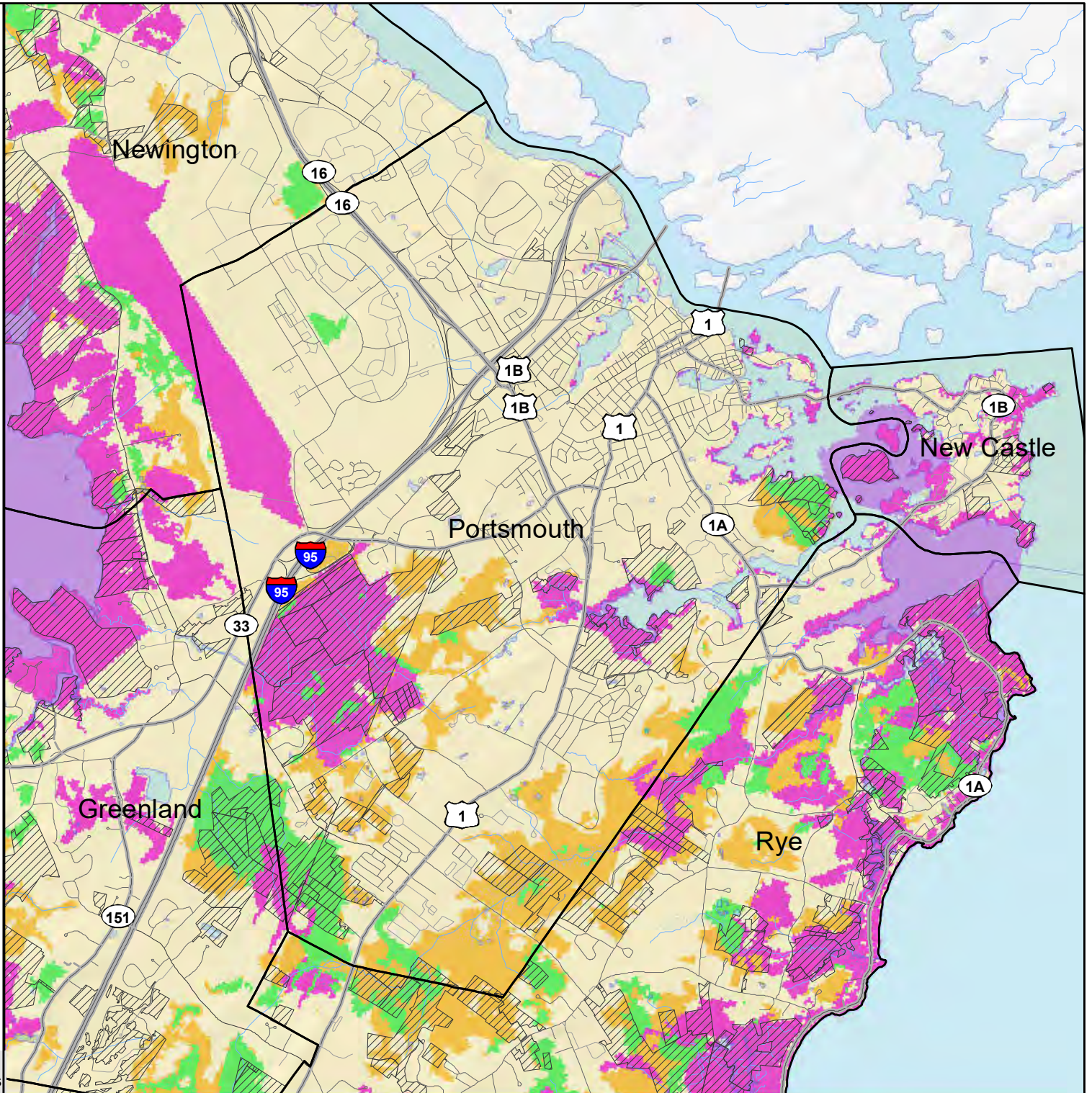

Base map data provided by NH GRANIT at UNH September 2019. Intended for planning use only.



0 1 2 Kilometers

0 1 2 Miles

Figure 6 Gove Environmental Services, Inc.'s "Upland Wetland Habitat Map"

Upland Wetland Habitat Map

Prepared By: Gove Environmental Services, Inc.
Date: 2/27/2020
BW 1 Inch = 400 Feet

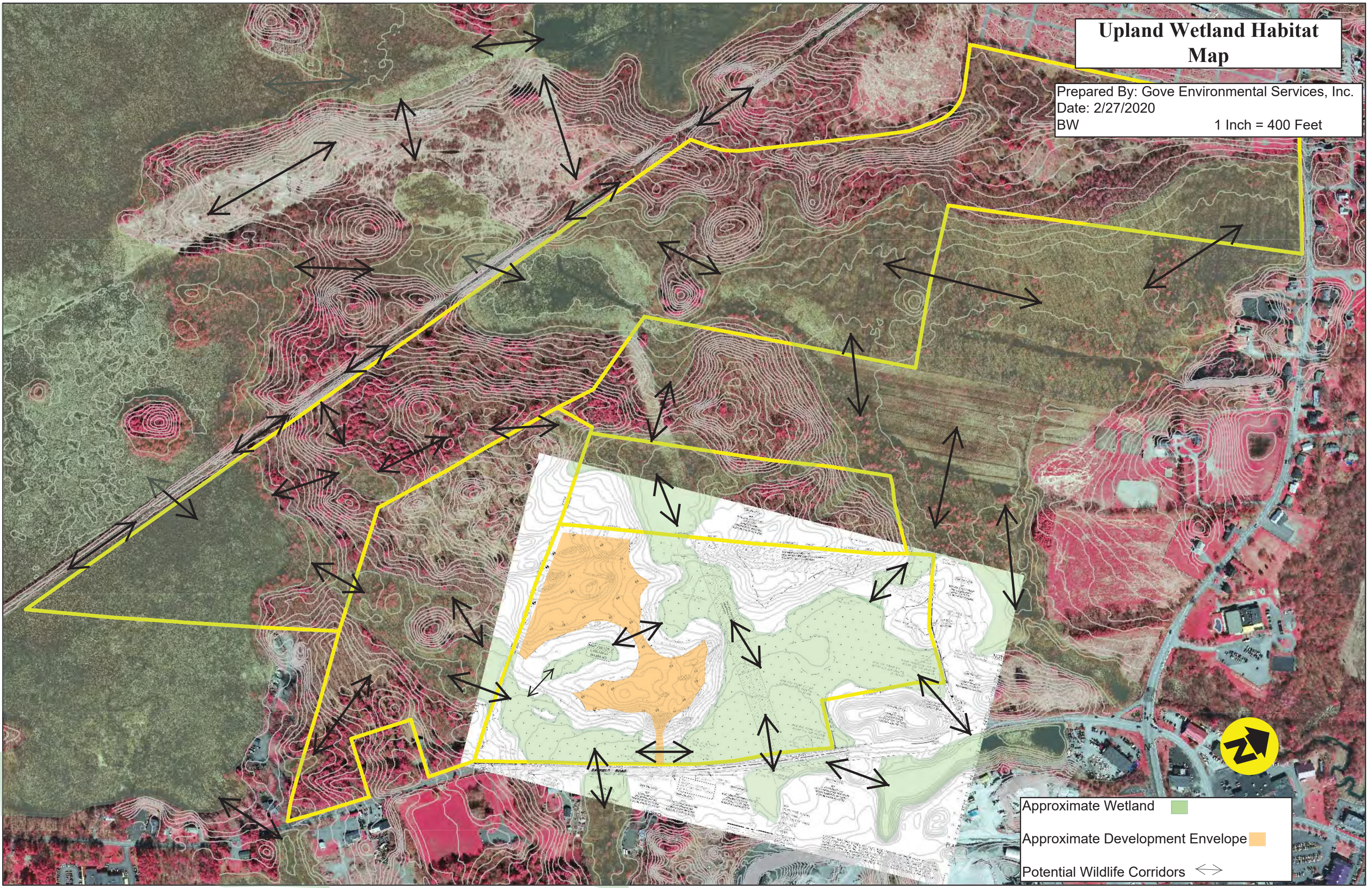

Approximate Wetland 

Approximate Development Envelope 

Potential Wildlife Corridors 

Appendix 1 Relevant Correspondence



GOVE ENVIRONMENTAL SERVICES, INC.

Memorandum

Date: Friday, February 28, 2020
To: Peter Britz, Environmental Planner
Org: Portsmouth Planning Department, 1 Junkins Avenue, Portsmouth, NH 03801
From: Jim Gove
Re: Banfield Road Project for Green and Company
Subject: Response to Mark West Review of January 28, 2020 and questions related to Wildlife corridors as related to the site

The review points out that the Nature Conservancy shows the site in question as part of a prioritized habitat block and wildlife corridor. The GES, Inc. reports have identified the presence of wildlife corridors on the site of which there are many both on and off the site as summarized below.

As noted by the review, GES, Inc. identified the access road to the site as potentially limiting wildlife movement along that specific corridor. What has not been recognized is that numerous wildlife corridors exist over the entire site and the lands beyond. GES, Inc. has attached a plan showing the site and the surrounding areas. The plan is named "Upland Wetland Habitat Map". The base map is an infrared aerial photo with the wetlands boundaries (outside of the site) being interpreted and the wetlands shown colored in green and the wildlife corridors have been shown as black arrows.

There are numerous wildlife corridors on and off the site. Wildlife movement is not confined to just the areas of the development, but are present around the site and in adjacent parcels. Most movement is along drainage ways, valleys, edges of wetlands, and along any streams. Wildlife also moves along man-made corridors, like railroad tracks and electric powerlines. Less movement is over the tops of hills, rock outcrops, and steep areas. The wildlife has many ways to move around the area, and move around the proposed development.

Of the numerous wildlife corridors shown, only two would be limited by the development.

- a. The first is at the wetland impact area along Banfield Road. In the West review, there was a concern that the proposed eco-passage was built with less height than recommended. The recommendation for the eco-passages is 2 feet high, with an opening of 2 feet wide. In redesigning this area, the eco-passages have been changed in the design, and are now proposed to have heights of 1.9 feet, 2.0 feet, and 2.2 feet. The openings all have a width of 5 feet which is 2.5 times larger than recommended, allowing for better wildlife passage. Where typically only one eco-passage is used, the project is proposing three eco-passages. The eco-

8 Continental Dr Bldg 2 Unit H, Exeter, NH 03833-7526

Ph (603) 778 0644 / Fax (603) 778 0654

www.gesinc.biz

info@gesinc.biz

passages now meet or exceed the recommended design. As discussed at the Conservation Commission meeting, these eco-passages are to help reptile and amphibian species to continue to move in the wetland. Also, the height of the access road across the wetlands is from 1.4 feet tall to 2.7 feet tall. This height of road will not be an impediment to deer, fox, coyote, raccoon, skunk, weasel, fisher, squirrel and chipmunk. There will continue to be wildlife movement through this corridor.

- b. The second is a valley between the two lobes of the development. The West review noted that the large retaining walls connecting the two development areas will permanently impact wildlife movement because the walls were up to 10 feet high and West recommended the elimination of the large retaining walls. In redesigning this area the retaining wall for the road connecting the two development areas is now reduced to 2 feet to 3.2 feet in height. This height will not be an impediment from the movement of mammals crossing along the corridor. As discussed above, deer, fox, coyote, skunk, raccoon, fisher, weasel, squirrel, or chipmunk will not find a 2-foot retaining wall an impediment to crossing through the valley between the two wetland areas. Further, the retaining wall is only on the north side of the proposed road, with the south side having no retaining wall.

These modifications clearly show that the Applicant has significantly minimized these impacts to these 2 travel corridors.

Another important point to note is that there has been discussion about the development area being the only upland on site, and that it is the only island of upland habitat in the area and is surrounded by wetlands. The Upland Wetland Habitat Map shows that this is in fact not the case. To the south, west and north of the development site are large areas of uplands. Going west from the development envelope is an uninterrupted continuous tract of upland habitat. To the south, after crossing a wetland, is another tract of upland. To the north, after crossing a wetland, is another tract of uplands.

On the site, of the 44.8 acres making up the subject property, 19.34 acres is wetlands and 25.46 acres of upland, with only 7.3 acres of upland and 0.09 acres of wetland for the crossing being used for the development area. This means that on the site, outside of the development envelope, is 18.2 acres of upland, which means approximately 40% of the 44.88 acre site will remain as undeveloped upland and approximately 83% of the 44.8 acre site will remain undeveloped overall.

In the West review, a recommendation was to provide information as to how the open space area will be managed and protected from future impact. The following is adapted from the Open Space restrictions of a condominium project in Atkinson:



The Open Space as depicted on the plans, is and shall forever be and remain subject to the following deed restrictions:

- 1) The purpose of the Open Space after completion of the proposed development depicted on the site plan is to retain the area forever in its scenic and open space conditions and to prevent any use of the Open Space that will significantly impair, or interfere with, its conservation value.
- 2) To protect and conserve the natural biological diversity of the region including exemplary natural communities, wetlands and other significant wildlife habitats on the restricted property.
- 3) It shall be maintained in perpetuity as open space.
- 4) No structure of any kind, size or shape shall be constructed on the Open Space.
- 5) Upon completion of the proposed development, no filling or excavation of soil or other alteration of topography or cutting or removal of standing trees shall be allowed, except those that present an imminent threat to person or property. In addition, trees may be removed in accordance with accepted silvacultural forest practices as outlined in the publication entitled **Good Forestry Practices in the Granite State** by the Society for the Protection of NH Forests. No disturbance of other natural features shall be allowed unless such activities are commonly necessary to maintain the existing natural environment of the open space.
- 6) There shall be no dumping or depositing of trash, debris, stumps, yard waste, hazardous fluid or materials, vehicle bodies or parts within the Open Space.

There has been discussion that there may be an alternative access to the site via an abutting parcel of land. The abutting parcel is not owned by the project and it was found not to be available to the project. In addition, the abutting property would also require a longer wetland crossing to access uplands. This is not a feasible access because it is not the least impacting alternative and is not owned by the project. Therefore, the proposed access road at the location depicted on Banfield Road is the least impacting alternative.

Copy to:

Mark West
and
NHDES Wetlands Bureau Application# 2020-0344.
Amended plans of eco-passages.

Attachments:

- 1) West Environmental Inc. letter of 01-28-2020
- 2) Upland/Wetland Habitat Plan
- 3) Eco-passage cross-section
- 4) RetroWall cross-section

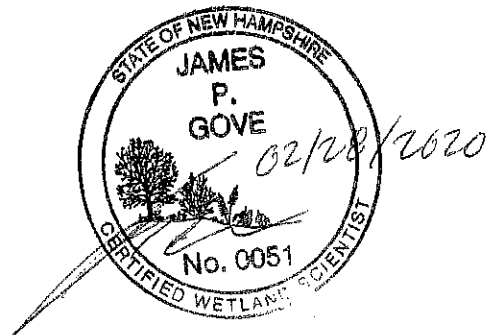

Peter Britz, Environmental Planner
Portsmouth Planning Department
1 Junkins Avenue
Portsmouth, NH 03801

January 28, 2020

RE: Third Review of Banfield Road Project Green and Company Portsmouth

Dear Peter:

West Environmental, Inc. (WEI) submits this third review report of the above referenced project based on information presented by the applicant at the December 11, 2019. Some of the new information presented addressed issues raised in our report from December 10, 2019 but no formal response to the report was submitted.

2019 Wildlife Habitat Assessment

As discussed in our 12-10-19 report the revised Wildlife Habitat Assessment (WHA) provides more information on wildlife habitat and the species that likely utilize this site. We have attached the Connect the Coast Map prepared by the Nature Conservancy indicating that the Hett parcel to be developed is within a Prioritized Habitat Block. In addition, this map confirms that wildlife movement is in an east-west direction.

WEI agrees with the statement "*The greatest issue with this development is the bisecting of the site with the proposed road, limiting any existing and potential wildlife travel.*" The reports from Gove Environmental indicate that development itself and the large retaining walls in the stretch of road connecting the two development areas **will permanently impact wildlife movement on the site**. The applicant's consultants presented information regarding the retaining walls (up to 10 feet high) and the proposed 4'x4' box culvert. While we understand that this design eliminated impacts to the wetland buffers the road itself now has a greater impact to wildlife movement.

The eco-passage located at the wetland crossing was also presented at the Conservation Commission Meeting to help reptile and amphibian species continue to move through the wetland. It is proposed to be built with less height than is recommended which may reduce its effectiveness to promote passage. WEI recommended consultation with the NH Fish and Game and we have reviewed email correspondence with Kim Tuttle.

She indicated that the design was interesting and had some basic recommendations but did not endorse the design. She also referred the applicant to Sandi Houghton at her office.

It is our understanding that the hydrology and septic designs are being independently reviewed.

Recommendations:

1. The applicant's consultants should examine alternative stormwater management designs that eliminate the large retaining walls in the under-road detention option and distribute the treatment systems into smaller watersheds. Some impact in the outer 25 feet of the 100-foot wetland buffer for smaller detention/treatment systems would have less impact on wildlife. These areas could also be planted with shrub buffers on their outer slopes to minimize habitat impact. There are also areas outside the 100-foot buffers where rain gardens could be located.
2. The applicant's consultants should continue to research the eco-passages to verify that they will function with an altered design.
3. The applicant should provide information as to how the open space area will be managed and protected from future impact. This element of the project is the most important mitigation for wildlife habitat impacts and it will require signage and other permanent restrictions.

Sincerely,
West Environmental, Inc.

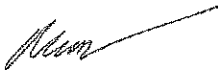

Mark C. West,
NH Certified Wetland Scientist

Cc: Vicky Nelson

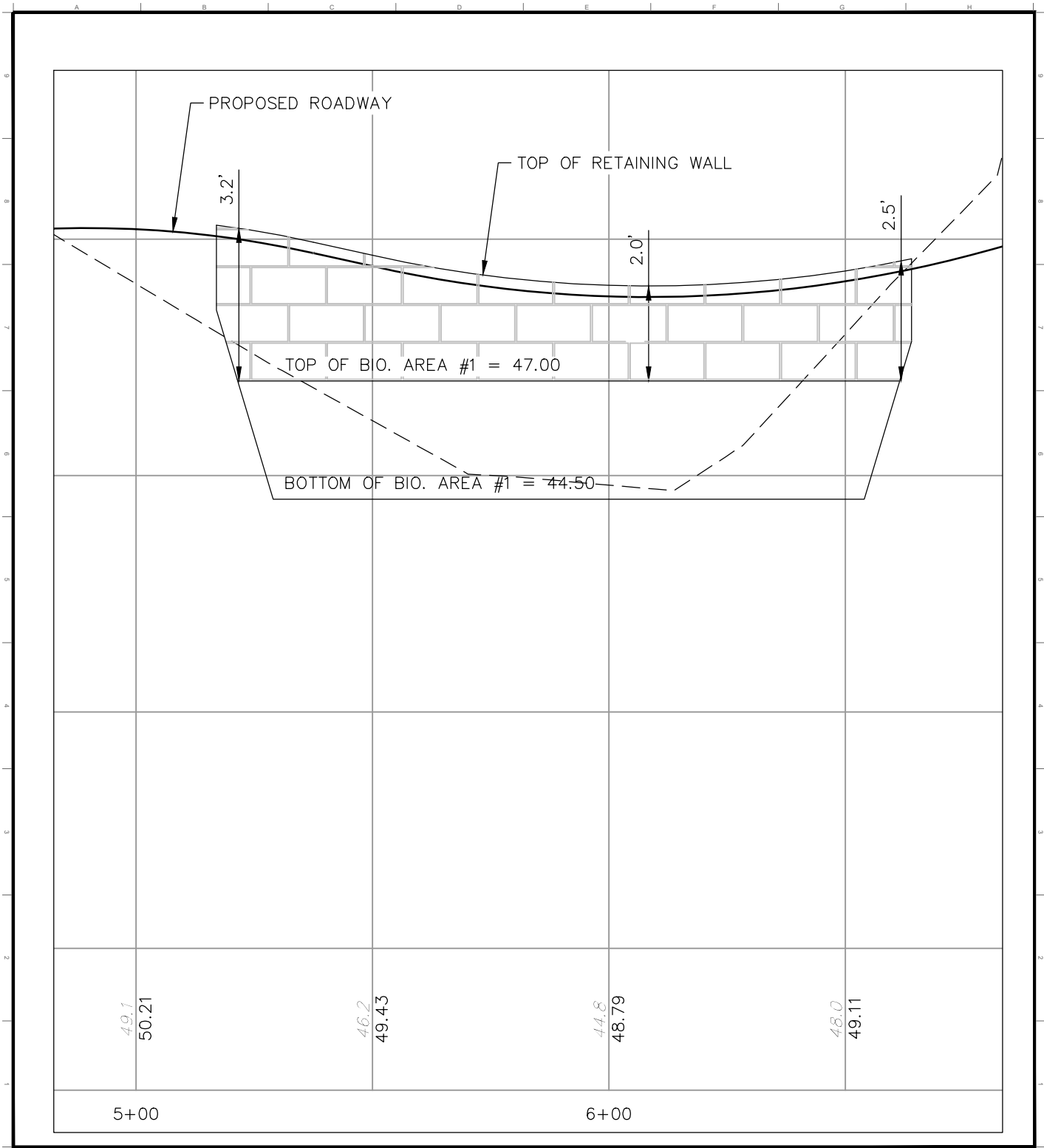

PROJECT #	47361.00	DR	FB
DATE		CK	CADFILE

Civil Engineers Structural
 Engineers Traffic
 Engineers Land Surveyors
 Landscape Architects
 Scientists

170 Commerce Way, Suite
 102 Portsmouth, NH 03801
 Phone (603) 431-2222
 Fax (603) 431-0910
 www.TFMoran.com

TAX MAP 256 LOT2
RETAINING WALL AREA
PROFILE
THE VILLAGE AT BANFIELD WOODS
PORTSMOUTH, NEW HAMPSHIRE
 OWNED BY
GREEN & COMPANY REAL ESTATE

SCALE: H:1"=30' / V:1"=3' **DATE: 2/20/20**

REV.	DATE

C-2



ROCKINGHAM COUNTY CONSERVATION DISTRICT

110 North Road, Brentwood, NH 03833-6614
Tel: 603-679-2790 • Fax: 603-679-2860
www.rockinghamccd.org

12 December 2019

Peter Britz, Environmental Planner
City of Portsmouth Planning Dept.
1 Junkins Avenue
Portsmouth, NH 03801

RE: Green & Company
Banfield Road
Tax map/lot: 256/2
RCCD job PR256-2 L19

Dear Mr. Britz;

Rockingham County Conservation District has received a revised Existing Conditions plan for this site by TFM/MSC revision dated 11 November 2019. This plan reflects the changes to the wetland delineation requested as the result of RCCD's wetland delineation field review on 5 November and report of 7 November 2019.

The wetland delineation is accurate and meets professional standards.

Please contact me if you have further questions about this work.

Sincerely,

Michael Cuomo
NH Certified Soil Scientist #6
NH Certified Wetland Scientist #4

Copy to Jack McTigue, PE, TFM/MSC

Appendix 2 Site Photographs



Photo 1. Facing northwest along proposed road (4/15/2020)



Photo 2. Facing northeast along proposed road (4/15/2020)



Photo 3. Facing south from proposed road (4/15/2020)



Photo 4. Facing northwest to northern building envelope and cul-de-sac area (4/15/2020)



Photo 5. Facing northwest from proposed cul-de-sac (4/15/2020)



Photo 6. Facing northeast to property line with rock wall boundary (4/15/2020)



Photo 7. Facing northeast from northwest corner of property lot (4/15/2020)



Photo 8. Facing south from northwest corner of property lot (4/15/2020)



Photo 9. Facing south near edge of northern building envelope and property line (4/15/2020)



Photo 10. Facing southeast to isolated wetland area, no frogs heard or seen and no egg masses or spermatophores observed. Rain within one week prior, deepest part of pool roughly 8 inches (4/15/2020)



Photo 11. Facing southeast along delineated wetland line (4/15/2020)



Photo 12. Facing northwest to southern building envelope area (4/15/2020)



Photo 13. Facing southeast to proposed road area (4/15/2020)



Photo 14. Facing northwest along proposed road to southern building envelope area (4/15/2020)



Photo 15. Facing southeast from proposed road at delineated wetland line towards Banfield Road (4/15/2020)



Photo 16. Facing east towards delineated wetland area (4/15/2020)



Photo 17. Facing east towards delineated wetland area (4/15/2020)



Photo 18. Facing west from southern building envelope (4/15/2020)



Photo 19. Facing north from edge of southern building envelope (4/15/2020)



Photo 20. Facing north towards delineated wetland (4/15/2020)



Photo 21. Facing northwest along transmission line right-of-way (4/15/2020)



Photo 22. Facing northwest along southeastern property line (4/15/2020)



Photo 23. Facing northeast to pocket of upland (4/15/2020)



Photo 24. Facing northeast towards delineated wetland area (4/15/2020)



Photo 25. Facing south to transmission line right-of-way from northern part of property (4/15/2020)



Photo 26. Facing east down transmission right-of way (4/15/2020)



Photo 27. Facing southeast to delineated wetland area (4/15/2020)



Photo 28. Facing northeast to wetland area with standing water. No frogs heard or seen and no egg masses or spermatophores observed. Rain within one week prior, deepest part of pool roughly 10 inches (4/15/2020)



Photo 29. Facing east to delineated wetland area (4/15/2020)



Photo 30. Facing north near eastern property boundary (4/15/2020)



Photo 31. Tree stand on eastern portion of property (4/15/2020)



Photo 32. Owl pellets observed near proposed road (4/15/2020)



Photo 33. Scat observed on western property line (4/15/2020)



Photo 34. Scat near southeast property line (4/15/2020)



Photo 35. Game trail (likely deer) through wetland at Banfield Road edge (4/15/2020)



Photo 36. Game trail (likely deer) at northeast end of property, facing east (4/15/2020)



Oak Hill Environmental Services

Wildlife Study For The Village at Banfield Woods

Prepared for: Green & Company
11 Lafayette Road
North Hampton, NH 03862

Date: May 5, 2020

Location: The Village at Banfield Woods
Tax Map/Lot 256/2
Banfield Road
Portsmouth, NH 03801



Wildlife Study For The Village at Banfield Woods

Executive Summary

A wildlife study was conducted and produced by Oak Hill Environmental Services for the Green & Company for a 44.88 acre parcel located on Banfield Road in Portsmouth NH. The study included a field survey of the property and surrounding area to evaluate the types of wildlife habitat present, record animal activity and assess what potential species may be found in the study area. The results of this study revealed a number of animal species utilizing this property with the highest usage in three wildlife travel corridors beyond the subject property boundaries to the East, West and North. The observations recorded during the survey and research performed on the surrounding properties consisting of interconnected wetland systems and uplands revealed where most wildlife activities and movements are occurring.

A part of the study includes an assessment of the degree of impacts and overall effect the proposed development project may have on the wildlife utilizing this site. The study brings into context ecologically where the subject property is located in relationship to surrounding ecosystems and the role it provides for wildlife. The amount of disturbance to a site and configuration of the development footprint in conjunction with mitigative measures employed is critical in evaluating the degree of impacts to wildlife.

Property Size: 44.88 acres

Uplands = 25.55 acres (57%)

Wetlands = 19.34 acres (43%)

Impacts to uplands = 7.24 acres (28% of uplands)

Impacts to wetlands = 0.09 acres (0.5% of wetlands)

Undeveloped uplands = 18.31 acres (72% of uplands)

Undeveloped wetlands = 19.25 acres (99.5% of wetlands)

After completion of the development 83% of the 44.8 acres will remain undeveloped.

There will be a minor direct impact on wildlife as a result of the development infrastructure and units with the loss of natural uplands and the habitat it provides. With only 17% of the property impacted, mitigative steps employed in the development design and the location of this property to the surrounding ecosystem's, impacts to wildlife are considered minor. The construction of eco-passages for the wetland crossings minimizes impacts to reptiles and amphibians and the design of the proposed drive should not create a significant impediment for other animal movements particularly since the primary wildlife travel corridors and animal activities observed are beyond the property boundaries or are adjacent to wetlands.

Oak Hill Environmental Services was retained by Green & Company to perform a wildlife study for the subject project area to make an assessment of the degree of impact and overall effect the proposed development project may have on the wildlife utilizing this site. This study includes a research of existing data maps i.e. National Wetlands Inventory, NH Wildlife Habitat Land Cover, NH Highest Ranked Wildlife Habitat by Ecological Condition, Aerial Photos, Topographic and Soils maps. A two day walkover of the subject parcel and portions of the edge of the Girl Scout property to the West/NW was conducted on April 21 & 22, to analyze both upland and wetland communities in context with adjoining properties and existing landscape, plant communities and ecotone changes. Animal sightings and sign activity were noted of presence and location. Evaluating the diversity of wildlife habitat conditions that are present aids in determining what species are currently utilizing this study area and what potential wildlife species that may occur in the study area. A wildlife species list from observed animal sign and sightings was compiled and is reported below.

There are distinct environmental factors to consider in assessing specific wildlife habitat, food source, water, cover/physical structure elements and their spatial distribution in conjunction with specific requirements needed for individual animal species. The subject property wildlife movements were evaluated within the existing property boundaries and in the larger context with connecting wetlands and uplands within the broader landscape to determine travel corridors and highest use areas.

The subject property is a total of 44.88 acres in size with 57% of the property (25.55 acres) mapped as uplands. The property is located in the Coastal Plain Region of the state and the plant community is designated Appalachian Oak and Pine. The dominant trees in the uplands are Red Oak and White Pine, Red Maple, Gray Birch and American Beech. Poplar and Yellow Birch are

intermixed in the forest cover closer to wetland areas. The shrub layer is thin within the dense canopy of the mature Oaks and Pines with some low-bush blueberry present.

Canada Mayflower grows in places within the herb layer. A thick litter of leaves covers the forest floor with logs and fallen dead branches and trees dispersed throughout the upland areas of the property that gently slopes from south to north. Rock /Ledge outcrops are numerous through the center of the property and extend to the northern property boundary and beyond. Wetlands occur along the south, east and west sides and are classified as Palustrine Forested Broad-Leaved Deciduous (PFO1) and Palustrine Scrub Shrub, Broad-Leaved Deciduous, Seasonally Flooded/Saturated, PSS1E.

Wetland plant community consist of Red Maple mostly in the tree layer and Highbush Blueberry, Winterberry, Speckled alder are present throughout the shrub layer and Skunk cabbage, sphagnum moss, sedges, rushes and grasses in the herb layer.

The plant communities that extend to abutting properties are a large mosaic of wetlands system that eventually connect with the Great Bog to the West and Northwest, and is forested to the North, East and West. Grass mostly and some shrubs grow within the utility corridor to the east and NE with a forested border. The Girl Scout camp property borders to the west with a gravel drive access. There exists a foot path trail system through this forested property with some seasonal structures and cabins interspersed and stone walls present on the east and west sides. A woods road runs along the northern edge of the subject property clear of shrubs and trees.

The walkover survey revealed wildlife travel/usage patterns with location of tracks and scat observed throughout the study area. The predominant areas where animals and their particular sign were observed are the following.

The gravel drive that runs along the western property boundary displayed numerous deer tracks and two sets of raccoon tracks. A stand of hemlock on the west side of the drive, on the Girl Scout property, is a potential winter deer yard. Two deer were observed running in this area. The open trail system on this property provides unobstructed travel corridors for a number of animals especially deer.

The woods road that abuts the northern property boundary is being utilized by many deer (tracks, scat, observed), Gray fox (scat observed) and some birds observed, (Cardinal, Chickadee, Robin, Phoebe, Chipping sparrow).

Within the upland center of the property very little sign activity was observed. Pileated woodpecker historic activity on a few dead trees. Middens (remnant pile of food) of acorns by squirrels and mice were noted in a few locations in this part of the property. An abundance of acorns and pine cones are dispersed throughout the forest floor.

The wetland areas from the east side to the west side provide excellent habitat for year round bird species and neotropical migratory birds seasonally. Observed a Hermit thrush and Flicker. Frogs and salamanders would be abundant in this habitat. Deer tracks were present along edge of the wetland to the east. Raccoon sign (scat) observed within the buffer area, 50 feet upslope from NE wetland edge. Potential species probable in buffer area to wetlands, Opossum, Porcupine, Fox, Weasel, Fisher.

Along the NE section of the property the utility corridor ecotone change provides wildlife habitat for a number of birds and mammals and is considered a major use wildlife travel corridor. Observed one turkey (live) many deer tracks and scat. Two turkey vultures flew overhead. Probable animal species utilizing this habitat are, Bobcat, Coyote, Fox, Hawks, Owls, woodchuck, skunk and small mammals, mice, moles and shrew.

When assessing the degree of impacts to wildlife and the overall effect the proposed development project will have on wildlife utilizing this property, both the individual parcel and its location within the surrounding larger ecosystems and significant roadway obstructions present are considered collectively. The subject parcel is located in the southeast section of a larger ecosystem and is designated as a Supporting Landscape on the Wildlife Habitat Ecological Conditions Map. Great Bog to the NW is designated Highest Ranked Habitat in New Hampshire. The NH Heritage Bureau records show no presence of Endangered Species or Species of Concern within the immediate project area.

The observations of wildlife presence and activity recorded during the survey reveal that the most animal sign occurred along the wetlands edge, the Gravel drive and Girl Scout property to the west and NW, the woods road beyond the northern boundary and the utility corridor to the east and NE. Banfield Rd along the southern boundary is a significant barrier for wildlife movements. In addition, to the south is a large industrial complex and urban development area with restrictive access of fences in places and the property possesses low habitat value. The animal movement is primarily moving towards the Northwest from the west side of the subject property and South to North along the eastside of the property and within the utility corridor.

Mr. Peter Britz's, Environmental Planner, letter of December 10, 2019 references Article 10 Section 10.1017.50 requiring that the applicant must satisfy certain conditions for approval of this project. The results of this wildlife study and the steps implemented into the design of this proposal by the applicant do address these conditions.

1. The land is reasonably suited to the use activity or alteration.

Although the proposal is located on undeveloped land the overall buildout for the project is only 7.33 acres leaving 83% (37.55 acres) of the parcel undeveloped. The wetland impacts are minimal, 0.09 acres, and the eco-passage structures proposed will retain the biological connection of this resource.

2. There is no alternative location outside the wetland buffer that is feasible and reasonable for the proposed use, activity or alteration.

The only access to the uplands portion of this property from Banfield Road requires crossing of wetlands. The proposed drive was located where the wetlands are narrowest and overall wetland impacts are minimized to the greatest extent possible.

3. There will be no adverse impact on the functional values of the site or surrounding properties.

The proposed project will impact animals utilizing the construction footprint but there is abundant similar habitat adjacent and beyond property boundaries. The wildlife study outlines existing conditions and observations of heaviest wildlife use and travel corridors which indicate the proposed project will not have an adverse effect to wildlife on surrounding properties. The NH Heritage Bureau records show no presence of Endangered Species or Species of Concern within the immediate project area.

4. Alteration of the natural vegetative state or managed woodland will occur only to the extent necessary to achieve construction goals.

Removal of trees will be minimized to the extent practical to construct the project and maintain safety. 72% of the uplands and 99.5% of the wetlands will remain in their natural state.

5. The proposed project does not maximize the buildout of units permissible under the city's guidelines.

The site allows for 24 units and 22 units are being developed so the project does not maximize the buildout of units.

6. Any area within the vegetated buffer strip will be returned to a natural state to the extent feasible.

The 100 ft. wetlands buffer is maintained around the buildout area and any temporary impacts will be minimized and revegetated with native species to return it to a natural state.

The proposed development building site foot print includes 7.33 acres of the 44.88 acre parcel, 17% of the overall parcel. The proposed access drive is 900 feet. The developed land area is mostly uplands with a small wetland crossing proposed at the narrowest section off Banfield Rd. Twenty two units are proposed at this site. A development of this size will have an unavoidable direct impact on wildlife with the removal of trees, live and dead that provide habitat and food for forest dwelling animals but it is minor in relationship to the larger ecosystem beyond the property boundaries and is minimize by its' location at the southeast edge of the larger area. The animals utilizing the forested habitat will retreat to the wetland buffer and beyond. The proposed placement of designed eco-structures under the proposed access road for the wetland crossing will help mitigate impacts and provide reptile and amphibian and small animals movements. The drive as designed does not create an impassable obstruction to larger animals.

Also, it is my understanding that the City Staff had concerns over density. In reviewing this the difference of impacts to wildlife if 2 units more or less than the 22 proposed would have a varying effect. Since the buildout footprint to construct 24 units or 20 units would utilize the same infrastructure area and physical impacts to the uplands are the same with no additional wetland or upland buffer impacts, the proposed development will have no additional effect on wildlife movement and activities. Because wildlife activity is highest along the wetlands edges and within the 100ft buffer as well as much higher use wildlife corridors existing beyond the subject property's boundaries, the overall impacts to wildlife as a result of the proposed development is considered minor.

Respectfully Submitted,



Daniel H. Geiger, CWS
Oak Hill Environmental Services

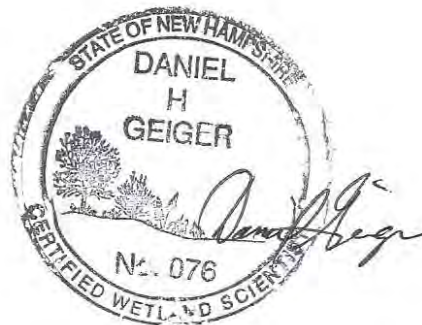



Oak Hill Environmental Services

Oak Hill Environmental Services provides professional environmental guidance, planning, and services to private individuals, companies, engineers, municipalities, and state and federal agencies. Oak Hill Environmental Services specializes in:

- **Environmental Reviews, Studies and Regulations**
- **USACOE Jurisdictional Wetland Delineation**
- **Wetlands: Permitting (local, state and federal), Evaluations, Functional Assessments, and Restorations**
- **Wildlife Ecology, Habitat Studies, Rare and Endangered Species**
- **Perform fresh water mussel surveys to determine presence of state or federally listed endangered species.**
- **Land Use Planning and Natural Resource Assessments**

Daniel H. Geiger, CWS, Owner

Over 25 years of experience as a practicing wetland scientist in New Hampshire, Maine, Massachusetts and Vermont.

Education

Bachelor of Science, Wildlife Biology/Botany, University of Montana
Advanced Studies in Wetland Science; Rutgers University/Cook College and the University of Massachusetts at Amherst.

Professional Certifications

New Hampshire Certified Wetland Scientist No. 76

Approved as qualified by the US Fish and Wildlife Service to conduct freshwater mussel surveys for assessing impacts to the federal/state endangered species, Dwarf wedgemussel *Alasmidonta heterodon*, and Brook floater *Alasmidonta varicosa*.

Professional History

1995 – Present	Oak Hill Environmental Services, Owner (Environmental Consulting)
1985 – 1995	New Hampshire Department of Transportation, Bureau of Environment, (Senior Environmental Manager)
1975-1980	US Forest Service, Fire Control/ Smokejumper, Region 1

Professional Affiliations

New Hampshire Association of Wetland Scientists, Past President
New Hampshire Association of Natural Resource Scientists
Appointed to State of New Hampshire, Joint Board of Natural Scientists, 2009-2013.

Honored by the New Hampshire Audubon as a life member for the Osprey Nesting Sites program.

Past Member of Town of Loudon Conservation Commission, 12 years.

Portsmouth, Banfield Rd April 21,22



View North, Start of proposed access road from Banfield Rd



View South, Wetland crossing, Banfield Rd in the distance

Portsmouth, Banfield Rd April 21,22



View North, Centerline beyond wetland crossing



A few dead snags are present

Portsmouth, Banfield Rd April 21,22



Dead snag, historic Pileated woodpecker sign



View NE, Rock out-crop near centerline.

Portsmouth, Banfield Rd April 21,22



View West from centerline



Deer scat, older

Portsmouth, Banfield Rd April 21,22



Younger Deer scat, more recent



Shallow pools present in wetland areas

Portsmouth, Banfield Rd April 21,22



View North at northern boundary, transition zone of plant communities.



Hermit Thrush

Portsmouth, Banfield Rd April 21,22



Wetland area NE section of property



Cavity being used by squirrel

Portsmouth, Banfield Rd April 21,22



Mouse midden



Gray Fox scat, note fur and small bones, uric acid (white color)

Portsmouth, Banfield Rd April 21,22



Deer track beyond northern property boundary



Eastern chipmunk, NW of Northern property boundary

Portsmouth, Banfield Rd April 21,22



Gravel drive along western property boundary



Raccoon track along gravel drive

Portsmouth, Banfield Rd April 21,22



View SE Utility corridor



View north utility corridor

Portsmouth, Banfield Rd April 21,22



Raccoon scat NE section of property

Portsmouth Plains Topo Map in Rockingham County New Hampshire

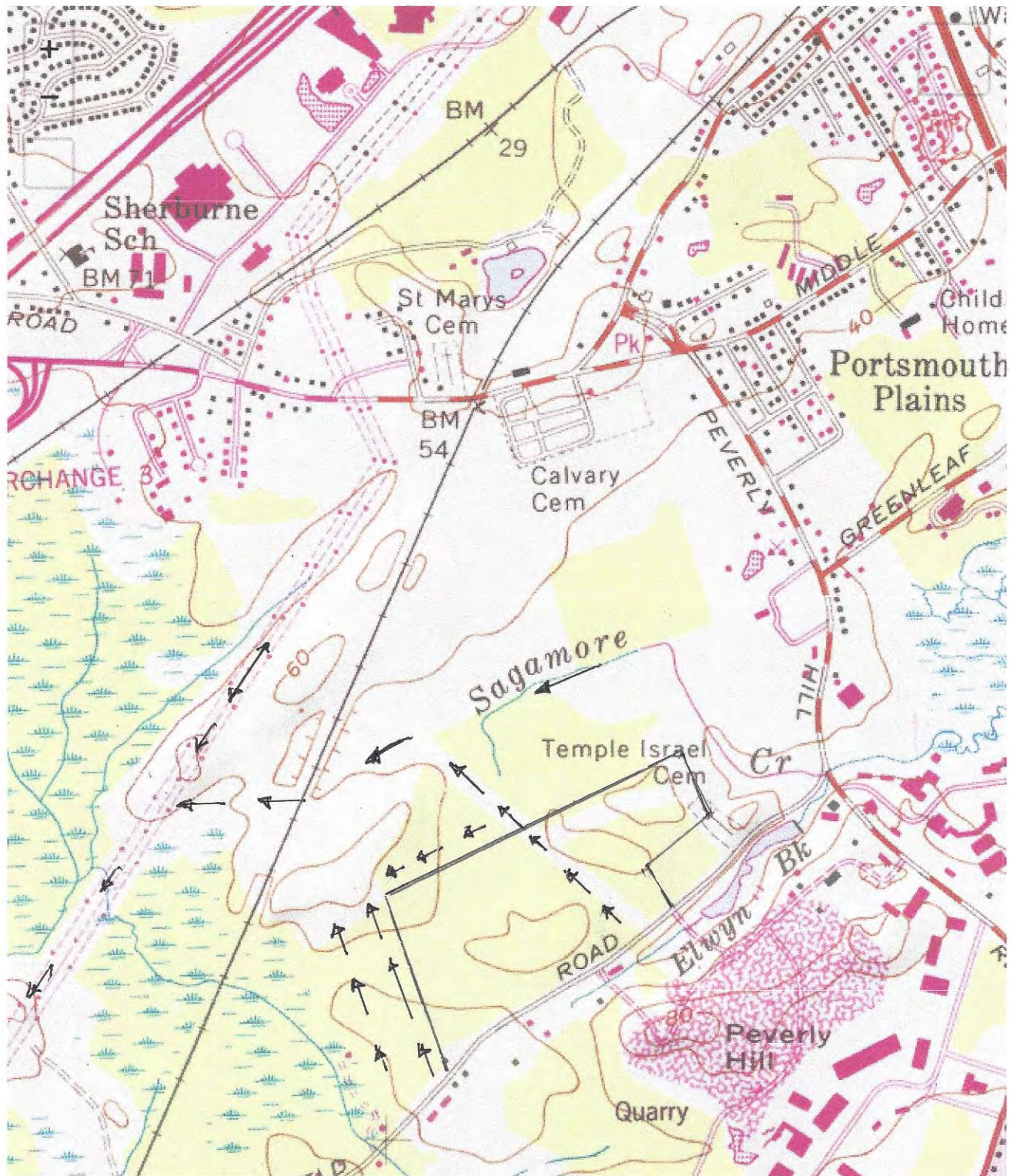

Portsmouth – Banfield Rd

Wildlife Travel Corridors

Map provided by TopoZone.com





June 23, 2020

Peter Britz
Environmental Planner
City of Portsmouth
1 Junkins Avenue, 3rd Floor
Portsmouth, NH 03801

Re: Update - Changes Made to Address Conservation Commission Comments

Dear Peter:

I am writing to you with mutual professional respect to address concerns about the subdivision which you have raised on various occasions. It was obvious to me that you put in a lot of thought and had the greatest number of specific questions. I appreciate that. My team and I tried to listen and make appropriate changes which compliment your concerns. Through this letter, I want to summarize how we have addressed everything which you raised.

Jim Gove provided a comprehensive wildlife study. For some reason, although it was, and is, a solid piece of work, you seemed unsatisfied. Accordingly, we have endeavored to gain your agreement that our approach is reasonable by submitting additional wildlife studies from two highly accredited and unbiased companies with which we have never worked before. Normandeau Associates, a nationally recognized leader in environmental consulting services, and Oak Hill Environmental, a well-respected New Hampshire environmental services firm. We asked them to address your concerns and gave them a copy of your letter, so they knew the specific issues raised. I am not sure if you have had the opportunity to read those reports but they further back up the position that the changes we have made to the plans have in fact minimized any impact on wildlife. I have attached the reports for your review. Further, we have attempted to have Mark West provide an updated report based on all changes we have made to the plans, further explained below, as all of his comments issued were prior to these significant changes. However, we were told that no further review was necessary.

We have made major revisions to the road and drainage. We have taken out the retaining wall on the road and replaced it with no wall on one side and approximately a 2-foot wall on the other for a short distance with no guardrail. We have increased the size of the eco passages and provided data to show the positive results of their use in parts of Canada. They are also being used now in Massachusetts. All three environmental consultants point out that multiple wildlife passages are available and that impact from this project is minimal. The information regarding these changes was never sent to Mark West.

We made significant changes regarding the drainage to address your concerns as well as the Conservation Commission. We have brought in two other companies—Dr. Robert Roseen of Waterstone Engineering, a well-respected engineering consulting company specializing in the design, planning, and permitting for stormwater management and nutrient controls and Stephen Keach of Keach Nordstrom which is a highly accredited firm which represents many towns to review the system. They are known to be both difficult and detail oriented in reviewing a project. They have added additional pre-treatment, an easy inspection port system and maintenance ports to allow the system to be cleaned and maintain the drainage system with conventional equipment. Further we have provided evidence that this type of system has been in use for decades. Severino construction has represented that in 35 years of similar installations none have ever failed or been dug up. They are in fact more reliable than a gravel wetland and easier to maintain. In contrast, they have had gravel wetlands require significant maintenance after a storm event. This system costs 10 times what a gravel wetland does and is more reliable and does not impact the buffer.

Constructing a gravel wetland at station 2+50 is uphill of the current drainage. If you read Keach Nordstrom's report-- to put a gravel wetland at this uphill location really doesn't work due to grading, would create a very deep pond which creates a safety hazard, would need a guardrail and would still impact the buffer at the outlet. TF Moran came up with another design with a gravel wetland where there was a shallower pond and it was not as unsightly. However, it would require further treatment down at the lower portion of the road for the additional road water that is left untreated --- which would mean another system in the buffer or another system in the road to deal with it. So the R-tank system in the road is a low impact design that is the best choice since it allows treatment of the most stormwater, with the least impact to the surrounding property and provides for easy monitoring and maintenance long into the future. Please see attached Severino Construction's letter that states in over 35 years of installing similar systems they have never had to replace or dig up even one.

As far as pure density goes this project is similar to many conservation subdivisions as far as spacing of the homes and there is actually 25.55 acres of uplands (57%) as part of the 44.88 Acres. We are only disturbing 7.24 acres of uplands or 16% of the overall site leaving 84% of the site in its natural vegetative state.

As evident from this summary, there has been significant professional review of this proposed subdivision. We have used overlapping experts in addition to the City's normal review process. In short this small subdivision has been scrutinized more than any project I have ever done. There is no valid technical basis to disapprove it. In light of all of the additional information, I ask for your professional support of this project.

Hoping we can move forward on this project with your endorsement. There is much ahead of us in the City of Portsmouth and I would like to move forward with the utmost of professionalism in the future.

Sincerely,



Richard Green
Green & Company

DRAINAGE ANALYSIS

F O R

The Village at Banfield Woods

**County of Rockingham
Portsmouth, New Hampshire**

Tax Map 256, Lot 2

**December 27, 2019
Last Revised May 5, 2020**

Prepared By:



Civil Engineers
Structural Engineers
Traffic Engineers
Land Surveyors
Landscape Architects
Scientists

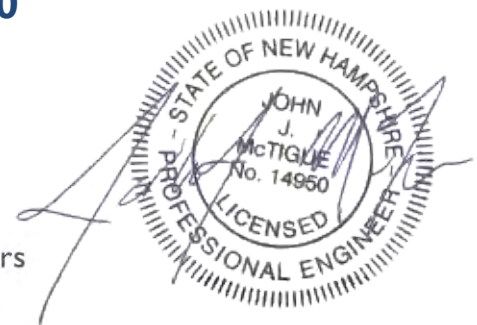

(This Page Is Intentionally Blank)

Contents

1.0 – SUMMARY AND PROJECT DESCRIPTION	D1
1.1 - Pre- and Post-Development Flow Comparison	D1
1.2 – Best Management Practices	D2
2.0 - CALCULATION METHODS	D2
4.0 – PRE-DEVELOPMENT CONDITION	D4
5.0 – POST-DEVELOPMENT CONDITION	D5
6.0 – BMP EFFICIENCIES	D6
7.0 – LOW IMPACT DESIGN	D6
8.0 – BEST MANAGEMENT PRACTICES	D7
8.1 – Temporary Practices:	D7
8.2 – Permanent Practices:	D9
8.0 – CONCLUSION	D9

Table of Figures

Table 1 - Pre and Post Flows	DError! Bookmark not defined.
Table 2 - Precipitation Estimates	DError! Bookmark not defined.
Table 3 - Project Curve Numbers	DError! Bookmark not defined.

Appedices

APPENDIX A - EXTREME PRECIPITATION TABLE	D11
APPENDIX B - PRE-DRAINAGE	D15
APPENDIX C - PRE-DRAINAGE (10 Yr. Storm Event)	D29
APPENDIX D - POST DRAINAGE	D41
APPENDIX E - POST DRAINAGE (10 Yr. Storm Event)	D63
APPENDIX F – BMP WORKSHEETS	D87
APPENDIX G –RIPRAP CALCULATIONS	D121
APPENDIX H – NRCS WEBSOILS	D137
APPENDIX I – SITE SPECIFIC SOIL SURVEY	D163
APPENDIX J – TEST PIT LOGS	D171
APPENDIX K –NHDES ONESTOP DATA MAPPER	D183
APPENDIX L – PRE AND POST DRAINAGE PLANS	D189

(This Page Is Intentionally Blank)

1.0 – SUMMARY AND PROJECT DESCRIPTION

The existing lot is 44.884 acres. The proposed site consists of a multi-family condominium comprising of 22 single-family dwelling units. The stormwater management system has gone through several iterations to minimize impacts to the 100' wetland buffer and provide a usable and sustainable drainage system.

The disturbance on the lot is limited to the western section of the lot. This is the area of focus for the drainage report. The proposed development will only effect 17% of the lot with a 5% impervious cover.

This drainage study was completed to assess the pre- and post-development runoff rates for the 2-year, 10-year, 25-year, and the 50-year storm events on the proposed site. The post development drainage flows remain the same or are less than the pre-development drainage flows.

In addition, Best Management Practices were developed to formulate a plan that assures stormwater quality both during and after construction. The following summarizes the findings from the study.

1.1 - Pre- and Post-Development Flow Comparison

The pre- and post-development watershed areas have been analyzed for the property. Table 1 compares pre- and post-development peak runoff rates during all storm events analyzed for each Point of Interest.

The drainage flows in post development remain the same or show a slight decrease for the pre-development Flows.

Area Number	2-Year (Flow - cfs)		2-Year (Volume - cf)		10-Year (Flow - cfs)		25-Year (Flow - cfs)		50-Year (Flow - cfs)	
	Pre-Dev.	Post-Dev.	Pre-Dev.	Post-Dev.	Pre-Dev.	Post-Dev.	Pre-Dev.	Post-Dev.	Pre-Dev.	Post-Dev.
POI-1	11.5	10.0	176,319	181,603	21.8	21.6	42.7	41.2	70.4	68.3
POI-2	0.3	0.3	3,189	3,189	1.1	1.1	1.8	1.8	2.5	2.5
Total Volume			179,508	184,729						

Table 1 - Pre and Post Flows

1.2 – Best Management Practices

Best Management Practices have been incorporated into the drainage design to provide for temporary erosion control measures during the construction process and permanent erosion control measures after construction is complete.

Temporary measures include construction sequencing, silt barriers and provisions for stabilization of inactive areas. Permanent erosion control measures include turf establishment on all disturbed areas that have not been paved, one bioretention area, two hybrid bioretention areas, two infiltration basins and one underground stormwater treatment system (USTS).

2.0 - CALCULATION METHODS

The design storms analyzed in this study are the 2-year, 10-year, 25-year and the 50-year, 24-hour storm events. The software program, HydroCAD version 10.00¹ was utilized to calculate the peak runoff rates from these storm events. The program estimates the peak rates using the TR-20 method. A Type III storm pattern was used in the model. Rainfall frequencies for the analyzed region were also incorporated into the model. Rainfall frequencies from the Northeast Regional Climate Center (NRCC) were used to determine the storm-event intensities, see Appendix A. The project lies in the Great Bay region. To account for this, a 15% increase was added to the storm-event intensities (see Table 2). Design standards were taken from the New Hampshire Stormwater Manual, December 2008².

	PRECIPITATION ESTIMATES	
Storm-Event (yr)	NRCC Rainfall (in)	115% Rainfall (in)
2	3.24	3.73
10	4.91	5.65
25	6.23	7.16
50	7.46	8.58

Table 2 - Precipitation Estimates

Time of Concentration is the time it takes for water to flow from the most hydraulically remote point to the watershed outlet following the route that takes the longest watercourse length. This time is determined by calculating the time it takes runoff to travel this route under one of three hydrologic conditions: sheet flow, shallow concentrated flow or channel flow. Because the Intensity-Duration-Frequency (IDF) curve is steep with short T_c 's, estimating the actual intensity is subject to error and overestimates actual runoff. Due to this, the T_c 's are adjusted to a minimum of 5 minutes.

¹ HydroCAD version 10.00, HydroCAD Software Solutions LLC, Chocorua, NH, 2013.

² New Hampshire Stormwater Manual: Volume One - Stormwater and Antidegradation, December 2008; Volume Two - Post-Construction Best Management Practices Selection and Design, December 2008; Volume Three - Erosion and Sediment Controls During Construction, December 2008.

Calculation Warnings

During the 10-year, 24-hour storm event, 5 warnings occurred:

[80] Warning: Pond PP03a Exceeded Pond CB01 by 1.37' @ 20.10 hrs (3.0 cfs 18,345 cf)

[80] Warning: Pond PP03a Exceeded Pond CB02 by 0.03' @ 23.58 hrs (0.6 cfs 3,162 cf)

- Both of these warnings are in reference to water being held in the catchbasins during the storm. The flows are contained in the Catch Basin, even in the 50-year storm.

[87] Warning: Pond CB01 Oscillations may require smaller dt or Finer Routing (severity=52)

[87] Warning: Pond CB02 Oscillations may require smaller dt or Finer Routing (severity=54)

[87] Warning: Pond PP04A Oscillations may require smaller dt or Finer Routing (severity=48)

- Two of these warnings are from the same catchbasins. The other is from the second set of R-Tank chambers. Changing the finer routing had little effect the oscillations. Decreasing the time increment (dt) only increased the oscillation. The oscillations happen at the beginning and end of the storms and do not affect peak runoff. The oscillation never exceeds 100 and are considered minor oscillations.

3.0 – Existing Soils

The National Resources Conservation Service (NRCS) Web Soil shows that approximately half the soil in the area to be (140) Chatfield-Hollis-Canton complex, 0 to 15 percent slopes and rocky. Chatfield soil is well drained soil with high runoff potential. It is grouped as a Hydrologic Soil Group B soil. Hollis soil is somewhat-excessively-drained with a very high runoff potential and grouped as a Hydrologic Soil Group D soil. Canton soil is a well-drained soil with a low runoff potential. It is grouped as a Hydrologic Soil Group B soil.

The next major soil group in the study area is (538) Squamscott fine sandy loam, 0 to 5 % slopes. It is a poorly drained soil with a medium runoff potential and grouped as a Hydrologic Soil Group C/D soil.

The remainder of the soil is classed as (134) Maybid silt loam, 0 to 5 % slopes, and (38) Eldridge fine sandy loam, 3 to 8 % slopes. Neither of these are in the area being developed, both are grouped as a Hydrologic Soil Group C/D soil. See Section 8 for more detail.

The Site Specific Soil Survey was performed in the western section of the lot, wher the proposed development occurs. Four groups of soil were defined in the report. (135) Chatfield Variant-Newfield Complex is the most prevalent soil in this area. The most predominant soil within this group is the Woodbridge soils, which are moderately well drained soils on dense glacial till. Newfield soils are moderately well drained loose glacial soils. These were classified as having a Hydrologic Soil Group C.

(41) Chatfield-Hollis-Rock Outcrop Complex is the other predominant upland soil. Chatfield is the largest component of the complex at 50%, Hollis is the next largest component at 30%. Lastly is the Rock Outcrop at 20%. These were classified as having a Hydrologic Soil Group B.

The largest wetland soil was classified as (538) Squamscott fine sandy loam. It is a poorly drained sand over marine silt soils. These were classified as having a Hydrologic Soil Group C.

(656) Ridgebury fine sandy loam makes up the last wetland soil and it is a poorly drained loamy soil which develops on dense glacial till. These were classified as having a Hydrologic Soil Group C. (See Section 15 for more detail.)

Curve numbers are based on the soil's hydrologic properties, ranging from 30 to 100. The lower numbers indicate that the soils have less runoff potential (amount of rainwater that is not retained) and higher curve numbers indicate the soils have a high runoff potential. Several curve numbers were used in the analysis of this property. (See Table 3 Below.) For areas in the buffer that are proposed to be mowed, once a year, a woods grass combo was used. This classification has a higher curve number than the undisturbed woods and smaller curve number than well maintained lawns.

Cover Types	B Soils	C Soils
Existing Woods - Woods Good	55	70
Powerlines – Powerlines - Brush, Good	48	65
Wetlands – Brush, Good	48	65
Lawns - >75% Grass Cover, Good	61	74
Restored Buffer Areas – Woods Grass Combo, Good (Areas that would be mowed one or less times a year)	58	72
Roads and Driveways – Paved Parking	98	98
Houses – Roofs	98	98

Table 3 - Project Curve Numbers

4.0 – PRE-DEVELOPMENT CONDITION

There are nine watershed areas that have been used to identify the pre-development conditions. The pre-development watersheds are depicted on the attached plan entitled “Pre-Development Drainage Plan Overall,” Section 20 - Sheet D-1.

Except for a small portion in the northeast corner of the lot (PPol-02), stormwater from offsite and onsite drain to two ‘valleys’ in the property. The first of these areas is orientated in a north/south direction near the middle of the property. The second area is orientated in the east/west direction, just north of Banfield Road. Wetlands exists in both of these areas.

The two low areas direct the water to two culverts near the middle of the property (PPol-1) that flow under Banfield road to the property to the south of Banfield Road. Stormwater flows from these culverts through swales and minor waterways to Sagamore Creek.

See Table 1 for Pre-development Stormwater Flows Offsite. Appendix A in this Drainage Study documents the peak runoff rates. Appendix B and C in this Drainage Study documents the computations for these peak stormwater flows.

5.0 – POST-DEVELOPMENT CONDITION

There are 24 drainage areas that have been used to define identify the post development condition. Post-development watershed areas are depicted on the attached plan entitled “Post-Development Drainage Plan Overall,” Section 20 - Sheet D-2 through D-4.

Table 1 summarizes the Post-Development Stormwater Flows Offsite for the 2-year, 10-year, 25-year and 50-year Type III storm events for the watershed areas. Appendix D and E in this Drainage Study documents the computations for these peak stormwater flows.

The small portion in the northeast corner of the lot (PPol-02) is not being developed and there is no change in rainfall flows or volumes.

Four Pretx units are used at the entrance to the site to capture water and provide pretreatment. Because of the topography and the locations of the wetlands and buffers, additional stormwater treatment is not feasible, without additional wetland and wetland buffer impact.

One underground stormwater treatment system (USTS) is used to capture runoff from the roadway, drives, and buildings from approximately 175' to 500' into the site. The USTS captures the water through four deep-sump catch basins, providing the pretreatment to the stormwater before it enters the system. Four sets of R-Tanks hold and detain the stormwater as it filters through a layer of engineered soil, removing most of the contaminants. Outlet structures meter the release during larger storms.

Two Hybrid bioretention areas treat the stormwater from 500' to the cul-de-sac, including some of the houses and drives along the outer edge of the cul-de-sac. The stormwater enters through four deep-sump catch basins for pretreatment prior to entering the ponding areas. Stormwater is held in the pond area as it filters through an engineered soil, filtering out contaminants. This hybrid design offers and anaerobic area (absence of free oxygen) that further aids in the denitrification process.

One conventional bioretention area is used to treat the stormwater for a portion of the cul-de-sac and the grassed area in the center of the cul-de-sac. A forebay near the front of the island in the cul-de-sac provides pretreatment prior to the water entering the Bioretention Area 1. Engineered soil will filter the stormwater before being captured by underdrains and flowing back into the undisturbed woods. An outlet control structure is used to meter the flow of the water to keep storm flows to minimum.

Two more infiltration basins capture some roof runoff and yard runoff, infiltrating stormwater runoff back into the ground. The stormwater runoff entering the infiltration basins are from roof runoff and lawns, therefore, not requiring pretreatment. The required groundwater recharge volume (GRV) based upon the additional impervious area is 1,190 cf. The two infiltration basins provide 1,695 cf of infiltration during a 2-year storm event which meets the threshold GRV for this site. (See BMP worksheets for more detail.)

The remainder of the roof runoff not captured by these systems will be treated by overland flow through the 100' wetland buffers.

The various stormwater treatment areas drain through the wetland to the two existing culverts that go under Banfield Road.

For channel protection, NHDES requires the post development 2-year volume not exceed the 0.1 acre-ft of the pre-development volume. This site meets this criterion.

For all storm events analyzed, the post development runoff from this site remains the same or slightly lower than the pre-development runoff. The proposed storm flows will have no adverse effects on the abutting properties or adjacent wetlands.

6.0 – BMP EFFICIENCIES

Appendix B of Volume 2 of the New Hampshire Stormwater Manual³ list the pollutant removal efficiencies of various BMP's.

The bioretention area and filtration practices are listed as having a 90% efficiency for removing Total Suspended Solids (TSS) and 65% efficiencies in removing Total Nitrogen (TN) and Total Phosphorous (TP). Based on UNHSC data, the Hybrid bioretention systems offer further denitrification of the stormwater, showing approximately a 30% increase in removal of TP and an additional 20% removal for TN.

Infiltration practices are listed as having a 90% efficiency for removing Total Suspended Solids (TSS), 60% efficiencies in removing Total Nitrogen (TN) and 65% efficiencies in removing Total Phosphorous (TP).

7.0 – LOW IMPACT DESIGN

Low Impact Design (LID) features are utilized in the design and implementation of this project. This site is laid out to provide the maximum greenspace for the proposed development. The total area of the lot is 44.884 acre (1,955,150 sf). The disturbed lot area is 7.613 acres (331,617 sf)⁴, leaving 32.271 acres (1,623,533) of undisturbed area. The percent undisturbed cover (%UDC) is 83%. The majority of this lot will be left in its natural state (83%).

The impervious cover on this lot, including roofs, is 2.279 acres (99,283 sf)⁵. The percent effective impervious area cover (%EIC) is only 5% of the lot. 5% impervious cover is a small amount for a development of this size.

³ New Hampshire Stormwater Manual: Volume One - Stormwater and Antidegradation, December 2008; Volume Two - Post-Construction Best Management Practices Selection and Design, December 2008; Volume Three - Erosion and Sediment Controls During Construction, December 2008.

⁴ Disturbed Lot Area (7.613 acres (331,617 sf)) = Total Disturbed Area (7.633 acres (332,478 sf)) – Disturbed Area Outside Lot (0.020 acres (861 sf))

⁵ Impervious Cover on this Lot = Total Additional Impervious Cover (2.290 acres (99,745 sf)) - the Additional Impervious Cover Outside the Right-of-way (0.011 acres (462 sf))

The initial impervious cover was reduced by implementing a narrower roadway, 20' wide, in place of the standard 28' wide roadway (two 12' lanes and a 4' shoulders/walkway). Additionally, a reduced radius was used on the cul-de-sac. This amounted to a 16,400 sf (35%) reduction in impervious roadway cover.

The impervious roadway in the cul-de-sac is being captured and treated using the Bioretention Area #1 which is using soil and plant-based media to filter and treat the stormwater. More of the impervious roadway is captured by Hybrid Bioretention Areas #2 and #3. These add an anaerobic zone on top of the filtration that the conventional bioretention area offers. The underground stormwater treatment system uses engineered soil to treat and attenuate stormwater flows, similar to the bioretention system. Refer to BMP Efficiencies for the pollutant efficiency removal rates.

In the April 2009 EPA article entitled "Managing Stormwater with Low Impact Development Practices: Addressing Barriers to LID" it speaks of LID's as "practices that manage stormwater by minimizing impervious cover and by using natural or man-made systems to filter and recharge stormwater into the ground. Roads, parking lots, and other types of impervious cover are the most significant contributors to stormwater runoff".

This project has minimized the impervious cover and provided treatment in several disperse filtration systems and provides more than the required groundwater recharge volume. It is a Low Impact Design.

8.0 – BEST MANAGEMENT PRACTICES

All soil erosion and sediment control measures shall be in accordance with regulations and principles as outlined in the *New Hampshire Stormwater Manual, Volumes Two and Three, December 2008*. The intent of the outlined measures is to minimize erosion and sedimentation during construction, stabilize and protect the site from erosion after construction is complete and mitigate any adverse impacts to stormwater quality resulting from development. Best Management Practices for this project include:

- Temporary practices to be implemented during construction.
- Permanent practices to be implemented after construction.

8.1 – Temporary Practices:

1. Erosion, sediment, and stormwater detention measures must be installed as shown on the plan.
2. All disturbed areas, as well as loam stockpiles, shall be seeded and contained by a silt barrier.

3. Silt barriers must be installed prior to any construction. All erosion control devices including silt barriers and storm drain inlet filters shall be inspected at least once per week and following any rainfall. All necessary maintenance shall be completed within twenty-four (24) hours.
4. Any silt barriers found to be failing must be replaced immediately. Sediment is to be removed from behind the silt fence if found to be one-third the height of the silt barrier or greater.
5. Any area of the site, which has been disturbed and where construction activity will not occur for more than twenty-one (21) days, shall be temporarily stabilized by mulching and seeding.
6. No construction materials shall be buried on-site.
7. After all areas have been stabilized, temporary practices are to be removed, and the area they are removed from must be smoothed and revegetated.
8. Areas must be temporarily stabilized within 14 days of disturbance or seeded and mulched within 3 days of final stabilization.
9. After November 15th, incomplete driveways or parking areas must be protected with a minimum of 3" of crushed gravel, meeting the standards of NHDOT item 304.3.
10. An area is considered stabilized if it has met one of the following:
 - a) A minimum of 85% vegetative growth has been established,
 - b) Base course gravel has been installed in areas to be paved,
 - c) Stone, rip rap, or any other non-erosive material has been installed with a minimum thickness of 3",
 - d) Erosion control blankets have been installed.

8.2 – Permanent Practices:

The objectives for developing permanent Best Management Practices for this site include the following:

1. Maintain existing runoff flow characteristics.
 - a) Drainage is structured to minimize any offsite increase in runoff,
2. Treatment BMP's are established to ensure the water quality,
3. Maintenance schedules are set to safeguard the long term working of the stormwater BMP's.

8.0 – CONCLUSION

The development of this lot, once construction is completed, will have a slight decrease in stormwater flows for the storm events analyzed and will have no adverse effects on surrounding properties or adjacent wetlands. There will be little to no change in the stormwater runoff characteristics for the lot. Appropriate erosion and sediment control practices will be implemented to reduce possible erosion and siltation. Best Management Practices will be developed in accordance with the *New Hampshire Stormwater Manual, Volumes Two and Three, December 2008* to formulate a plan that assures stormwater quality both during and after construction.

Submitted by,
TFMoran, Inc.

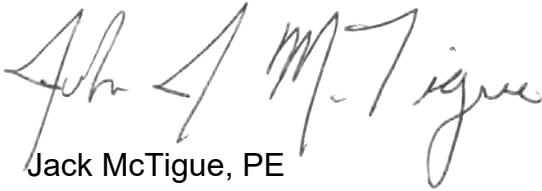

Jack McTigue, PE
Project Manager

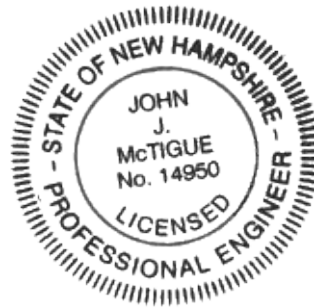

(This Page Is Intentionally Blank)

APPENDIX A
EXTREME PRECIPITATION TABLE

(This Page Is Intentionally Blank)

Extreme Precipitation Tables

Northeast Regional Climate Center

Data represents point estimates calculated from partial duration series. All precipitation amounts are displayed in inches.

Smoothing	Yes
State	New Hampshire
Location	
Longitude	70.793 degrees West
Latitude	43.041 degrees North
Elevation	0 feet
Date/Time	Tue, 22 Oct 2019 08:54:52 -0400

Extreme Precipitation Estimates

	5min	10min	15min	30min	60min	120min		1hr	2hr	3hr	6hr	12hr	24hr	48hr		1day	2day	4day	7day	10day	
1yr	0.26	0.40	0.50	0.65	0.82	1.04	1yr	0.71	0.98	1.22	1.57	2.04	2.68	2.95	1yr	2.37	2.83	3.25	3.97	4.59	1yr
2yr	0.32	0.50	0.62	0.81	1.02	1.30	2yr	0.88	1.18	1.52	1.95	2.50	3.24	3.60	2yr	2.86	3.46	3.97	4.71	5.36	2yr
5yr	0.37	0.58	0.73	0.98	1.25	1.61	5yr	1.08	1.47	1.89	2.44	3.16	4.10	4.62	5yr	3.63	4.44	5.08	5.98	6.76	5yr
10yr	0.41	0.65	0.82	1.12	1.45	1.90	10yr	1.25	1.73	2.24	2.91	3.77	4.91	5.58	10yr	4.35	5.36	6.14	7.17	8.05	10yr
25yr	0.48	0.76	0.97	1.34	1.78	2.35	25yr	1.54	2.15	2.79	3.65	4.77	6.23	7.16	25yr	5.51	6.89	7.88	9.12	10.15	25yr
50yr	0.54	0.86	1.10	1.54	2.08	2.77	50yr	1.79	2.53	3.30	4.35	5.71	7.46	8.67	50yr	6.61	8.33	9.53	10.93	12.10	50yr
100yr	0.60	0.97	1.25	1.78	2.43	3.27	100yr	2.09	2.99	3.92	5.19	6.82	8.95	10.48	100yr	7.92	10.08	11.52	13.11	14.43	100yr
200yr	0.68	1.11	1.43	2.05	2.84	3.85	200yr	2.45	3.53	4.64	6.17	8.15	10.72	12.68	200yr	9.49	12.19	13.94	15.74	17.21	200yr
500yr	0.80	1.32	1.72	2.50	3.49	4.79	500yr	3.01	4.40	5.80	7.76	10.31	13.63	16.31	500yr	12.07	15.69	17.92	20.04	21.75	500yr

Lower Confidence Limits

	5min	10min	15min	30min	60min	120min		1hr	2hr	3hr	6hr	12hr	24hr	48hr		1day	2day	4day	7day	10day	
1yr	0.23	0.36	0.44	0.59	0.72	0.89	1yr	0.63	0.87	0.92	1.32	1.67	2.25	2.57	1yr	1.99	2.47	2.88	3.16	3.92	1yr
2yr	0.32	0.49	0.60	0.81	1.00	1.19	2yr	0.86	1.16	1.37	1.82	2.34	3.08	3.49	2yr	2.73	3.36	3.86	4.59	5.11	2yr
5yr	0.35	0.54	0.67	0.92	1.18	1.41	5yr	1.01	1.38	1.61	2.12	2.73	3.83	4.26	5yr	3.39	4.09	4.77	5.61	6.32	5yr
10yr	0.39	0.60	0.74	1.03	1.33	1.61	10yr	1.15	1.57	1.81	2.39	3.06	4.43	4.96	10yr	3.92	4.77	5.55	6.52	7.31	10yr
25yr	0.44	0.67	0.84	1.20	1.58	1.91	25yr	1.36	1.87	2.10	2.76	3.54	4.76	6.03	25yr	4.21	5.80	6.82	7.97	8.84	25yr
50yr	0.49	0.74	0.92	1.33	1.79	2.18	50yr	1.54	2.13	2.35	3.07	3.94	5.38	6.99	50yr	4.76	6.73	7.97	9.28	10.23	50yr
100yr	0.54	0.82	1.03	1.49	2.04	2.49	100yr	1.76	2.43	2.63	3.42	4.36	6.05	8.11	100yr	5.36	7.79	9.33	10.81	11.82	100yr
200yr	0.60	0.91	1.15	1.66	2.32	2.84	200yr	2.00	2.77	2.94	3.78	4.82	6.79	9.40	200yr	6.01	9.03	10.92	12.62	13.69	200yr
500yr	0.70	1.04	1.34	1.95	2.78	3.39	500yr	2.40	3.32	3.42	4.32	5.50	7.92	11.42	500yr	7.01	10.98	13.45	15.51	16.59	500yr

Upper Confidence Limits

	5min	10min	15min	30min	60min	120min		1hr	2hr	3hr	6hr	12hr	24hr	48hr		1day	2day	4day	7day	10day	
1yr	0.29	0.44	0.54	0.72	0.89	1.09	1yr	0.77	1.06	1.26	1.74	2.20	3.02	3.16	1yr	2.67	3.04	3.61	4.40	5.09	1yr
2yr	0.34	0.52	0.64	0.86	1.07	1.27	2yr	0.92	1.24	1.48	1.96	2.51	3.45	3.71	2yr	3.06	3.57	4.10	4.86	5.68	2yr
5yr	0.40	0.62	0.77	1.05	1.34	1.62	5yr	1.15	1.59	1.88	2.53	3.24	4.37	4.97	5yr	3.87	4.78	5.41	6.39	7.17	5yr
10yr	0.47	0.72	0.89	1.25	1.61	1.98	10yr	1.39	1.93	2.28	3.10	3.93	5.38	6.19	10yr	4.76	5.96	6.79	7.85	8.76	10yr
25yr	0.58	0.88	1.09	1.56	2.05	2.57	25yr	1.77	2.51	2.95	4.06	5.12	7.86	8.30	25yr	6.95	7.98	9.07	10.33	11.41	25yr
50yr	0.67	1.02	1.27	1.83	2.46	3.13	50yr	2.12	3.06	3.59	4.98	6.27	9.84	10.38	50yr	8.71	9.98	11.30	12.71	13.95	50yr
100yr	0.79	1.19	1.49	2.16	2.96	3.81	100yr	2.55	3.73	4.36	6.13	7.69	12.31	12.97	100yr	10.90	12.47	14.07	15.65	17.05	100yr
200yr	0.92	1.39	1.76	2.55	3.55	4.65	200yr	3.07	4.55	5.32	7.55	9.44	15.45	16.23	200yr	13.67	15.61	17.54	19.27	20.86	200yr
500yr	1.14	1.70	2.19	3.18	4.52	6.04	500yr	3.90	5.90	6.90	9.97	12.40	20.87	21.84	500yr	18.47	21.00	23.47	25.36	27.25	500yr



(This page is intentionally blank)

APPENDIX B
PRE-DRAINAGE

(This Page Is Intentionally Blank)

**PRE-DEVELOPMENT
DRAINAGE**

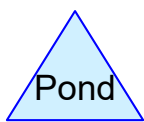
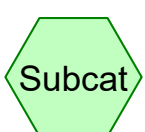
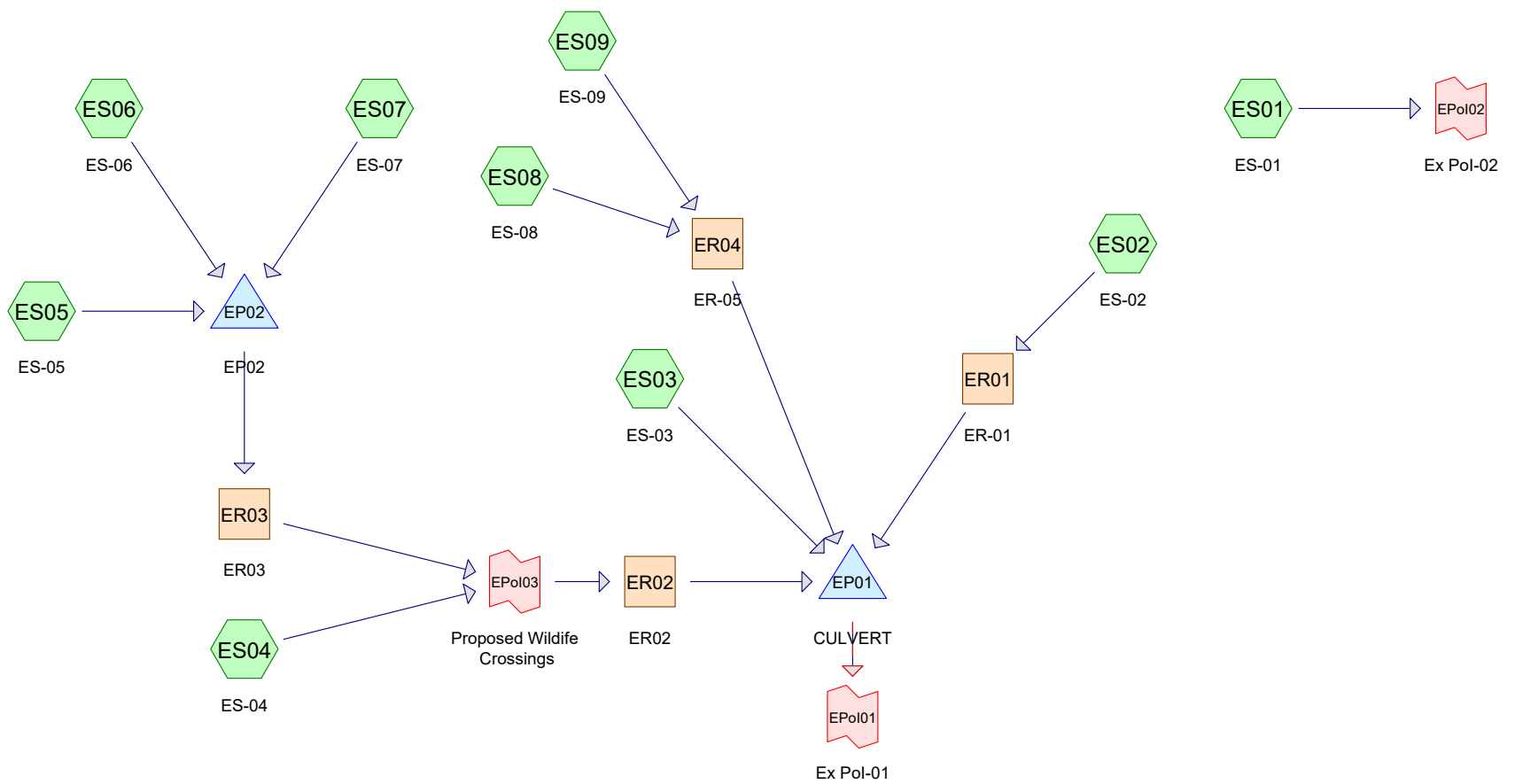

Routing Diagram for 477361-00_PRE-&-POST_2020-04-20
 Prepared by {enter your company name here}, Printed 4/28/2020
 HydroCAD® 10.10-3a s/n 00866 © 2020 HydroCAD Software Solutions LLC

(This Page Is Intentionally Blank)

477361-00_PRE-&-POST_2020-04-20

Prepared by {enter your company name here}

Printed 4/28/2020

HydroCAD® 10.10-3a s/n 00866 © 2020 HydroCAD Software Solutions LLC

Page 1

Area Listing (selected nodes)

Area (sq-ft)	CN	Description (subcatchment-numbers)
101,486	48	Brush, Good, HSG B (ES01, ES02, ES03, ES08, ES09)
393,326	65	Brush, Good, HSG C (ES01, ES02, ES04, ES05, ES06, ES07, ES08, ES09)
18,932	98	Paved parking, HSG C (ES03, ES04)
138,635	48	Power Line - Brush, Good, HSG B (ES01, ES02, ES03, ES09)
135,237	65	Power Line - Brush, Good, HSG C (ES01, ES02, ES03, ES08, ES09)
920,956	55	Woods, Good, HSG B (ES01, ES02, ES03, ES04, ES05, ES06, ES08, ES09)
1,288,885	70	Woods, Good, HSG C (ES01, ES02, ES03, ES04, ES05, ES06, ES07, ES08, ES09)
2,997,457	63	TOTAL AREA

477361-00_PRE-&-POST_2020-04-20

Prepared by {enter your company name here}

Printed 4/28/2020

HydroCAD® 10.10-3a s/n 00866 © 2020 HydroCAD Software Solutions LLC

Page 2

Soil Listing (selected nodes)

Area (sq-ft)	Soil Group	Subcatchment Numbers
0	HSG A	
1,161,077	HSG B	ES01, ES02, ES03, ES04, ES05, ES06, ES08, ES09
1,836,380	HSG C	ES01, ES02, ES03, ES04, ES05, ES06, ES07, ES08, ES09
0	HSG D	
0	Other	
2,997,457		TOTAL AREA

Time span=0.00-24.00 hrs, dt=0.06 hrs, 401 points x 2
Runoff by SCS TR-20 method, UH=SCS, Weighted-CN
Reach routing by Dyn-Stor-Ind method - Pond routing by Dyn-Stor-Ind method

Subcatchment ES01: ES-01	Runoff Area=57,405 sf 0.00% Impervious Runoff Depth>0.67" Flow Length=415' Tc=53.2 min CN=61 Runoff=0.3 cfs 3,189 cf
Subcatchment ES02: ES-02	Runoff Area=501,780 sf 0.00% Impervious Runoff Depth>0.45" Flow Length=740' Tc=95.8 min CN=56 Runoff=1.2 cfs 18,634 cf
Subcatchment ES03: ES-03	Runoff Area=502,327 sf 1.43% Impervious Runoff Depth>0.97" Flow Length=800' Tc=40.5 min CN=67 Runoff=5.8 cfs 40,633 cf
Subcatchment ES04: ES-04	Runoff Area=477,519 sf 2.46% Impervious Runoff Depth>1.02" Flow Length=1,231' Tc=53.0 min CN=68 Runoff=5.1 cfs 40,654 cf
Subcatchment ES05: ES-05	Runoff Area=117,705 sf 0.00% Impervious Runoff Depth>1.02" Flow Length=350' Slope=0.0200 '/' Tc=43.1 min CN=68 Runoff=1.4 cfs 10,053 cf
Subcatchment ES06: ES-06	Runoff Area=57,841 sf 0.00% Impervious Runoff Depth>0.97" Flow Length=374' Tc=29.7 min CN=67 Runoff=0.8 cfs 4,695 cf
Subcatchment ES07: ES-07	Runoff Area=42,503 sf 0.00% Impervious Runoff Depth>1.09" Flow Length=250' Tc=27.5 min CN=69 Runoff=0.7 cfs 3,848 cf
Subcatchment ES08: ES-08	Runoff Area=202,428 sf 0.00% Impervious Runoff Depth>1.03" Flow Length=695' Tc=34.9 min CN=68 Runoff=2.7 cfs 17,334 cf
Subcatchment ES09: ES-09	Runoff Area=1,037,949 sf 0.00% Impervious Runoff Depth>0.62" Flow Length=1,835' Tc=75.9 min CN=60 Runoff=4.6 cfs 53,255 cf
Reach ER01: ER-01	Avg. Flow Depth=0.03' Max Vel=0.25 fps Inflow=1.2 cfs 18,634 cf n=0.050 L=537.0' S=0.0065 '/' Capacity=1,413.2 cfs Outflow=1.0 cfs 18,085 cf
Reach ER02: ER02	Avg. Flow Depth=0.11' Max Vel=0.31 fps Inflow=5.1 cfs 50,841 cf n=0.080 L=635.0' S=0.0058 '/' Capacity=703.8 cfs Outflow=3.8 cfs 49,004 cf
Reach ER03: ER03	Avg. Flow Depth=0.02' Max Vel=0.20 fps Inflow=0.8 cfs 10,875 cf n=0.080 L=981.0' S=0.0180 '/' Capacity=1,122.7 cfs Outflow=0.5 cfs 10,186 cf
Reach ER04: ER-05	Avg. Flow Depth=0.08' Max Vel=0.44 fps Inflow=5.7 cfs 70,588 cf n=0.080 L=682.0' S=0.0161 '/' Capacity=2,431.4 cfs Outflow=5.2 cfs 68,974 cf
Pond EP01: CULVERT	Peak Elev=24.20' Storage=5,119 cf Inflow=12.0 cfs 176,696 cf Primary=11.5 cfs 176,319 cf Secondary=0.0 cfs 0 cf Outflow=11.5 cfs 176,319 cf
Pond EP02: EP02	Peak Elev=43.58' Storage=8,453 cf Inflow=2.7 cfs 18,596 cf Outflow=0.8 cfs 10,875 cf
Link EP01: Ex Pol-01	Inflow=11.5 cfs 176,319 cf Primary=11.5 cfs 176,319 cf

477361-00_PRE-&-POST_2020-04-20

Prepared by {enter your company name here}

HydroCAD® 10.10-3a s/n 00866 © 2020 HydroCAD Software Solutions LLC

Pre-Development

Type III 24-hr 2-YR Rainfall=3.73"

Printed 4/28/2020

Page 4

Link EPol02: Ex Pol-02

Inflow=0.3 cfs 3,189 cf

Primary=0.3 cfs 3,189 cf

Link EPol03: Proposed Wildlife Crossings

Inflow=5.1 cfs 50,841 cf

Primary=5.1 cfs 50,841 cf

Total Runoff Area = 2,997,457 sf Runoff Volume = 192,296 cf Average Runoff Depth = 0.77"
99.37% Pervious = 2,978,525 sf 0.63% Impervious = 18,932 sf

Time span=0.00-24.00 hrs, dt=0.06 hrs, 401 points x 2
 Runoff by SCS TR-20 method, UH=SCS, Weighted-CN
 Reach routing by Dyn-Stor-Ind method - Pond routing by Dyn-Stor-Ind method

Subcatchment ES01: ES-01	Runoff Area=57,405 sf 0.00% Impervious Runoff Depth>1.75" Flow Length=415' Tc=53.2 min CN=61 Runoff=1.1 cfs 8,366 cf
Subcatchment ES02: ES-02	Runoff Area=501,780 sf 0.00% Impervious Runoff Depth>1.35" Flow Length=740' Tc=95.8 min CN=56 Runoff=4.8 cfs 56,442 cf
Subcatchment ES03: ES-03	Runoff Area=502,327 sf 1.43% Impervious Runoff Depth>2.25" Flow Length=800' Tc=40.5 min CN=67 Runoff=14.6 cfs 94,062 cf
Subcatchment ES04: ES-04	Runoff Area=477,519 sf 2.46% Impervious Runoff Depth>2.32" Flow Length=1,231' Tc=53.0 min CN=68 Runoff=12.5 cfs 92,516 cf
Subcatchment ES05: ES-05	Runoff Area=117,705 sf 0.00% Impervious Runoff Depth>2.33" Flow Length=350' Slope=0.0200 '/ Tc=43.1 min CN=68 Runoff=3.5 cfs 22,865 cf
Subcatchment ES06: ES-06	Runoff Area=57,841 sf 0.00% Impervious Runoff Depth>2.25" Flow Length=374' Tc=29.7 min CN=67 Runoff=2.0 cfs 10,862 cf
Subcatchment ES07: ES-07	Runoff Area=42,503 sf 0.00% Impervious Runoff Depth>2.43" Flow Length=250' Tc=27.5 min CN=69 Runoff=1.6 cfs 8,597 cf
Subcatchment ES08: ES-08	Runoff Area=202,428 sf 0.00% Impervious Runoff Depth>2.34" Flow Length=695' Tc=34.9 min CN=68 Runoff=6.6 cfs 39,407 cf
Subcatchment ES09: ES-09	Runoff Area=1,037,949 sf 0.00% Impervious Runoff Depth>1.66" Flow Length=1,835' Tc=75.9 min CN=60 Runoff=14.8 cfs 143,476 cf
Reach ER01: ER-01	Avg. Flow Depth=0.08' Max Vel=0.42 fps Inflow=4.8 cfs 56,442 cf n=0.050 L=537.0' S=0.0065 '/ Capacity=1,413.2 cfs Outflow=4.5 cfs 55,208 cf
Reach ER02: ER02	Avg. Flow Depth=0.22' Max Vel=0.49 fps Inflow=13.9 cfs 125,703 cf n=0.080 L=635.0' S=0.0058 '/ Capacity=703.8 cfs Outflow=12.2 cfs 122,960 cf
Reach ER03: ER03	Avg. Flow Depth=0.07' Max Vel=0.42 fps Inflow=5.3 cfs 34,464 cf n=0.080 L=981.0' S=0.0180 '/ Capacity=1,122.7 cfs Outflow=3.0 cfs 33,187 cf
Reach ER04: ER-05	Avg. Flow Depth=0.16' Max Vel=0.70 fps Inflow=17.7 cfs 182,883 cf n=0.080 L=682.0' S=0.0161 '/ Capacity=2,431.4 cfs Outflow=17.1 cfs 179,807 cf
Pond EP01: CULVERT	Peak Elev=25.76' Storage=83,762 cf Inflow=39.3 cfs 452,036 cf Primary=21.8 cfs 451,376 cf Secondary=0.0 cfs 0 cf Outflow=21.8 cfs 451,376 cf
Pond EP02: EP02	Peak Elev=43.72' Storage=11,287 cf Inflow=6.7 cfs 42,324 cf Outflow=5.3 cfs 34,464 cf
Link EP01: Ex Pol-01	Inflow=21.8 cfs 451,376 cf Primary=21.8 cfs 451,376 cf

477361-00_PRE-&POST_2020-04-20

Prepared by {enter your company name here}

HydroCAD® 10.10-3a s/n 00866 © 2020 HydroCAD Software Solutions LLC

Pre-Development

Type III 24-hr 10-YR Rainfall=5.65"

Printed 4/28/2020

Page 6

Link EPol02: Ex Pol-02

Inflow=1.1 cfs 8,366 cf

Primary=1.1 cfs 8,366 cf

Link EPol03: Proposed Wildlife Crossings

Inflow=13.9 cfs 125,703 cf

Primary=13.9 cfs 125,703 cf

Total Runoff Area = 2,997,457 sf Runoff Volume = 476,593 cf Average Runoff Depth = 1.91"
99.37% Pervious = 2,978,525 sf 0.63% Impervious = 18,932 sf

Time span=0.00-24.00 hrs, dt=0.06 hrs, 401 points x 2
 Runoff by SCS TR-20 method, UH=SCS, Weighted-CN
 Reach routing by Dyn-Stor-Ind method - Pond routing by Dyn-Stor-Ind method

Subcatchment ES01: ES-01	Runoff Area=57,405 sf 0.00% Impervious Runoff Depth>2.78" Flow Length=415' Tc=53.2 min CN=61 Runoff=1.8 cfs 13,302 cf
Subcatchment ES02: ES-02	Runoff Area=501,780 sf 0.00% Impervious Runoff Depth>2.26" Flow Length=740' Tc=95.8 min CN=56 Runoff=8.5 cfs 94,422 cf
Subcatchment ES03: ES-03	Runoff Area=502,327 sf 1.43% Impervious Runoff Depth>3.40" Flow Length=800' Tc=40.5 min CN=67 Runoff=22.5 cfs 142,514 cf
Subcatchment ES04: ES-04	Runoff Area=477,519 sf 2.46% Impervious Runoff Depth>3.50" Flow Length=1,231' Tc=53.0 min CN=68 Runoff=19.1 cfs 139,214 cf
Subcatchment ES05: ES-05	Runoff Area=117,705 sf 0.00% Impervious Runoff Depth>3.51" Flow Length=350' Slope=0.0200 '/' Tc=43.1 min CN=68 Runoff=5.3 cfs 34,398 cf
Subcatchment ES06: ES-06	Runoff Area=57,841 sf 0.00% Impervious Runoff Depth>3.41" Flow Length=374' Tc=29.7 min CN=67 Runoff=3.0 cfs 16,452 cf
Subcatchment ES07: ES-07	Runoff Area=42,503 sf 0.00% Impervious Runoff Depth>3.63" Flow Length=250' Tc=27.5 min CN=69 Runoff=2.4 cfs 12,840 cf
Subcatchment ES08: ES-08	Runoff Area=202,428 sf 0.00% Impervious Runoff Depth>3.51" Flow Length=695' Tc=34.9 min CN=68 Runoff=10.1 cfs 59,273 cf
Subcatchment ES09: ES-09	Runoff Area=1,037,949 sf 0.00% Impervious Runoff Depth>2.66" Flow Length=1,835' Tc=75.9 min CN=60 Runoff=24.9 cfs 230,355 cf
Reach ER01: ER-01	Avg. Flow Depth=0.11' Max Vel=0.54 fps Inflow=8.5 cfs 94,422 cf n=0.050 L=537.0' S=0.0065 '/' Capacity=1,413.2 cfs Outflow=8.2 cfs 92,827 cf
Reach ER02: ER02	Avg. Flow Depth=0.31' Max Vel=0.59 fps Inflow=24.1 cfs 193,227 cf n=0.080 L=635.0' S=0.0058 '/' Capacity=703.8 cfs Outflow=21.7 cfs 189,947 cf
Reach ER03: ER03	Avg. Flow Depth=0.11' Max Vel=0.55 fps Inflow=9.1 cfs 55,735 cf n=0.080 L=981.0' S=0.0180 '/' Capacity=1,122.7 cfs Outflow=6.2 cfs 54,013 cf
Reach ER04: ER-05	Avg. Flow Depth=0.22' Max Vel=0.86 fps Inflow=29.3 cfs 289,628 cf n=0.080 L=682.0' S=0.0161 '/' Capacity=2,431.4 cfs Outflow=28.6 cfs 285,926 cf
Pond EP01: CULVERT	Peak Elev=26.20' Storage=163,831 cf Inflow=67.9 cfs 711,214 cf Primary=23.9 cfs 618,854 cf Secondary=18.8 cfs 91,441 cf Outflow=42.7 cfs 710,295 cf
Pond EP02: EP02	Peak Elev=43.81' Storage=13,224 cf Inflow=10.2 cfs 63,690 cf Outflow=9.1 cfs 55,735 cf
Link EP01: Ex Pol-01	Inflow=42.7 cfs 710,295 cf Primary=42.7 cfs 710,295 cf

477361-00_PRE-&POST_2020-04-20

Prepared by {enter your company name here}

HydroCAD® 10.10-3a s/n 00866 © 2020 HydroCAD Software Solutions LLC

Pre-Development

Type III 24-hr 25-YR Rainfall=7.16"

Printed 4/28/2020

Page 8

Link EPol02: Ex Pol-02

Inflow=1.8 cfs 13,302 cf

Primary=1.8 cfs 13,302 cf

Link EPol03: Proposed Wildlife Crossings

Inflow=24.1 cfs 193,227 cf

Primary=24.1 cfs 193,227 cf

Total Runoff Area = 2,997,457 sf Runoff Volume = 742,770 cf Average Runoff Depth = 2.97"
99.37% Pervious = 2,978,525 sf 0.63% Impervious = 18,932 sf

Time span=0.00-24.00 hrs, dt=0.06 hrs, 401 points x 2
 Runoff by SCS TR-20 method, UH=SCS, Weighted-CN
 Reach routing by Dyn-Stor-Ind method - Pond routing by Dyn-Stor-Ind method

Subcatchment ES01: ES-01	Runoff Area=57,405 sf 0.00% Impervious Runoff Depth>3.84" Flow Length=415' Tc=53.2 min CN=61 Runoff=2.5 cfs 18,392 cf
Subcatchment ES02: ES-02	Runoff Area=501,780 sf 0.00% Impervious Runoff Depth>3.22" Flow Length=740' Tc=95.8 min CN=56 Runoff=12.6 cfs 134,614 cf
Subcatchment ES03: ES-03	Runoff Area=502,327 sf 1.43% Impervious Runoff Depth>4.57" Flow Length=800' Tc=40.5 min CN=67 Runoff=30.4 cfs 191,246 cf
Subcatchment ES04: ES-04	Runoff Area=477,519 sf 2.46% Impervious Runoff Depth>4.67" Flow Length=1,231' Tc=53.0 min CN=68 Runoff=25.6 cfs 186,014 cf
Subcatchment ES05: ES-05	Runoff Area=117,705 sf 0.00% Impervious Runoff Depth>4.69" Flow Length=350' Slope=0.0200 '/' Tc=43.1 min CN=68 Runoff=7.1 cfs 45,955 cf
Subcatchment ES06: ES-06	Runoff Area=57,841 sf 0.00% Impervious Runoff Depth>4.58" Flow Length=374' Tc=29.7 min CN=67 Runoff=4.1 cfs 22,075 cf
Subcatchment ES07: ES-07	Runoff Area=42,503 sf 0.00% Impervious Runoff Depth>4.82" Flow Length=250' Tc=27.5 min CN=69 Runoff=3.3 cfs 17,076 cf
Subcatchment ES08: ES-08	Runoff Area=202,428 sf 0.00% Impervious Runoff Depth>4.69" Flow Length=695' Tc=34.9 min CN=68 Runoff=13.5 cfs 79,179 cf
Subcatchment ES09: ES-09	Runoff Area=1,037,949 sf 0.00% Impervious Runoff Depth>3.70" Flow Length=1,835' Tc=75.9 min CN=60 Runoff=35.3 cfs 320,406 cf
Reach ER01: ER-01	Avg. Flow Depth=0.14' Max Vel=0.62 fps Inflow=12.6 cfs 134,614 cf n=0.050 L=537.0' S=0.0065 '/' Capacity=1,413.2 cfs Outflow=12.2 cfs 132,764 cf
Reach ER02: ER02	Avg. Flow Depth=0.38' Max Vel=0.67 fps Inflow=34.4 cfs 261,044 cf n=0.080 L=635.0' S=0.0058 '/' Capacity=703.8 cfs Outflow=31.4 cfs 257,296 cf
Reach ER03: ER03	Avg. Flow Depth=0.14' Max Vel=0.64 fps Inflow=12.5 cfs 77,068 cf n=0.080 L=981.0' S=0.0180 '/' Capacity=1,122.7 cfs Outflow=9.6 cfs 75,030 cf
Reach ER04: ER-05	Avg. Flow Depth=0.28' Max Vel=0.98 fps Inflow=41.3 cfs 399,585 cf n=0.080 L=682.0' S=0.0161 '/' Capacity=2,431.4 cfs Outflow=40.5 cfs 395,285 cf
Pond EP01: CULVERT	Peak Elev=26.41' Storage=209,760 cf Inflow=97.6 cfs 976,590 cf Primary=24.9 cfs 717,300 cf Secondary=45.5 cfs 258,096 cf Outflow=70.4 cfs 975,396 cf
Pond EP02: EP02	Peak Elev=43.88' Storage=14,875 cf Inflow=13.7 cfs 85,106 cf Outflow=12.5 cfs 77,068 cf
Link EP01: Ex Pol-01	Inflow=70.4 cfs 975,396 cf Primary=70.4 cfs 975,396 cf

477361-00_PRE-&-POST_2020-04-20

Prepared by {enter your company name here}

HydroCAD® 10.10-3a s/n 00866 © 2020 HydroCAD Software Solutions LLC

Pre-Development

Type III 24-hr 50-YR Rainfall=8.58"

Printed 4/28/2020

Page 10

Link EPol02: Ex Pol-02

Inflow=2.5 cfs 18,392 cf

Primary=2.5 cfs 18,392 cf

Link EPol03: Proposed Wildlife Crossings

Inflow=34.4 cfs 261,044 cf

Primary=34.4 cfs 261,044 cf

Total Runoff Area = 2,997,457 sf Runoff Volume = 1,014,957 cf Average Runoff Depth = 4.06"
99.37% Pervious = 2,978,525 sf 0.63% Impervious = 18,932 sf

APPENDIX C
PRE-DRAINAGE
(10 Yr Storm Event)

(This Page Is Intentionally Blank)

477361-00_PRE-&POST_2020-04-20

Prepared by {enter your company name here}

HydroCAD® 10.10-3a s/n 00866 © 2020 HydroCAD Software Solutions LLC

Pre-Development - 10yr
Type III 24-hr 10-YR Rainfall=5.65"

Printed 4/28/2020

Page 1

Summary for Subcatchment ES01: ES-01

Runoff = 1.1 cfs @ 12.78 hrs, Volume= 8,366 cf, Depth> 1.75"

Runoff by SCS TR-20 method, UH=SCS, Weighted-CN, Time Span= 0.00-24.00 hrs, dt= 0.06 hrs
Type III 24-hr 10-YR Rainfall=5.65"

Area (sf)	CN	Description
9,442	55	Woods, Good, HSG B
122	48	Brush, Good, HSG B
* 13,602	48	Power Line - Brush, Good, HSG B
16,200	70	Woods, Good, HSG C
7,778	65	Brush, Good, HSG C
10,261	65	Power Line - Brush, Good, HSG C
57,405	61	Weighted Average
57,405		100.00% Pervious Area

Tc (min)	Length (feet)	Slope (ft/ft)	Velocity (ft/sec)	Capacity (cfs)	Description
49.1	100	0.0100	0.03		Sheet Flow, Sheet-Flow Woods: Dense underbrush n= 0.800 P2= 3.23"
3.4	205	0.0400	1.00		Shallow Concentrated Flow, Shallow Concentrated Woodland Kv= 5.0 fps
0.7	110	0.0100	2.68	374.84	Channel Flow, Channel Flow Area= 140.0 sf Perim= 80.9' r= 1.73' n= 0.080 Earth, long dense weeds
53.2	415	Total			

Summary for Subcatchment ES02: ES-02

Runoff = 4.8 cfs @ 13.43 hrs, Volume= 56,442 cf, Depth> 1.35"

Runoff by SCS TR-20 method, UH=SCS, Weighted-CN, Time Span= 0.00-24.00 hrs, dt= 0.06 hrs
Type III 24-hr 10-YR Rainfall=5.65"

Area (sf)	CN	Description
209,453	55	Woods, Good, HSG B
82,831	48	Brush, Good, HSG B
53,777	48	Power Line - Brush, Good, HSG B
21,794	70	Woods, Good, HSG C
126,184	65	Brush, Good, HSG C
7,741	65	Power Line - Brush, Good, HSG C
501,780	56	Weighted Average
501,780		100.00% Pervious Area

477361-00_PRE-&-POST_2020-04-20

Prepared by {enter your company name here}

HydroCAD® 10.10-3a s/n 00866 © 2020 HydroCAD Software Solutions LLC

Pre-Development - 10yr
Type III 24-hr 10-YR Rainfall=5.65"

Printed 4/28/2020

Page 2

Tc (min)	Length (feet)	Slope (ft/ft)	Velocity (ft/sec)	Capacity (cfs)	Description
37.2	100	0.0200	0.04		Sheet Flow, Shallow Woods: Dense underbrush n= 0.800 P2= 3.23"
58.0	550	0.0010	0.16		Shallow Concentrated Flow, Shallow Channel Woodland Kv= 5.0 fps
0.6	90	0.0100	2.41	714.05	Channel Flow, Concentrated Area= 296.0 sf Perim= 200.0' r= 1.48' n= 0.080 Earth, long dense weeds
95.8	740	Total			

Summary for Subcatchment ES03: ES-03

Runoff = 14.6 cfs @ 12.59 hrs, Volume= 94,062 cf, Depth> 2.25"

Runoff by SCS TR-20 method, UH=SCS, Weighted-CN, Time Span= 0.00-24.00 hrs, dt= 0.06 hrs
Type III 24-hr 10-YR Rainfall=5.65"

Area (sf)	CN	Description
66,527	55	Woods, Good, HSG B
16,804	48	Brush, Good, HSG B
844	48	Power Line - Brush, Good, HSG B
7,176	98	Paved parking, HSG C
109,654	70	Woods, Good, HSG C
229,477	70	Woods, Good, HSG C
71,845	65	Power Line - Brush, Good, HSG C
502,327	67	Weighted Average
495,151		98.57% Pervious Area
7,176		1.43% Impervious Area

Tc (min)	Length (feet)	Slope (ft/ft)	Velocity (ft/sec)	Capacity (cfs)	Description
28.2	100	0.0400	0.06		Sheet Flow, Sheet Flow Woods: Dense underbrush n= 0.800 P2= 3.23"
12.3	700	0.0360	0.95		Shallow Concentrated Flow, Shallow Flow Woodland Kv= 5.0 fps
40.5	800	Total			

Summary for Subcatchment ES04: ES-04

Runoff = 12.5 cfs @ 12.76 hrs, Volume= 92,516 cf, Depth> 2.32"

Runoff by SCS TR-20 method, UH=SCS, Weighted-CN, Time Span= 0.00-24.00 hrs, dt= 0.06 hrs
Type III 24-hr 10-YR Rainfall=5.65"

477361-00_PRE-&POST_2020-04-20

Prepared by {enter your company name here}

HydroCAD® 10.10-3a s/n 00866 © 2020 HydroCAD Software Solutions LLC

Pre-Development - 10yr
Type III 24-hr 10-YR Rainfall=5.65"

Printed 4/28/2020

Page 3

Area (sf)	CN	Description
0	98	Paved parking, HSG B
19,701	55	Woods, Good, HSG B
0	48	Brush, Good, HSG B
11,756	98	Paved parking, HSG C
284,228	70	Woods, Good, HSG C
161,834	65	Brush, Good, HSG C
477,519	68	Weighted Average
465,763		97.54% Pervious Area
11,756		2.46% Impervious Area

Tc (min)	Length (feet)	Slope (ft/ft)	Velocity (ft/sec)	Capacity (cfs)	Description
37.2	100	0.0200	0.04		Sheet Flow, Sheet Flow Woods: Dense underbrush n= 0.800 P2= 3.23"
9.7	421	0.0210	0.72		Shallow Concentrated Flow, Shallow Flow Woodland Kv= 5.0 fps
6.1	710	0.0070	1.95	699.40	Channel Flow, Channel Flow Area= 358.0 sf Perim= 254.0' r= 1.41' n= 0.080 Earth, long dense weeds
53.0	1,231	Total			

Summary for Subcatchment ES05: ES-05

Runoff = 3.5 cfs @ 12.62 hrs, Volume= 22,865 cf, Depth> 2.33"

Runoff by SCS TR-20 method, UH=SCS, Weighted-CN, Time Span= 0.00-24.00 hrs, dt= 0.06 hrs
Type III 24-hr 10-YR Rainfall=5.65"

Area (sf)	CN	Description
9,092	55	Woods, Good, HSG B
91,250	70	Woods, Good, HSG C
17,363	65	Brush, Good, HSG C
117,705	68	Weighted Average
117,705		100.00% Pervious Area

Tc (min)	Length (feet)	Slope (ft/ft)	Velocity (ft/sec)	Capacity (cfs)	Description
37.2	100	0.0200	0.04		Sheet Flow, Sheet Flow Woods: Dense underbrush n= 0.800 P2= 3.23"
5.9	250	0.0200	0.71		Shallow Concentrated Flow, Shallow Channel Woodland Kv= 5.0 fps
43.1	350	Total			

477361-00_PRE-&POST_2020-04-20

Prepared by {enter your company name here}

HydroCAD® 10.10-3a s/n 00866 © 2020 HydroCAD Software Solutions LLC

Pre-Development - 10yr

Type III 24-hr 10-YR Rainfall=5.65"

Printed 4/28/2020

Page 4

Summary for Subcatchment ES06: ES-06

Runoff = 2.0 cfs @ 12.44 hrs, Volume= 10,862 cf, Depth> 2.25"

Runoff by SCS TR-20 method, UH=SCS, Weighted-CN, Time Span= 0.00-24.00 hrs, dt= 0.06 hrs
Type III 24-hr 10-YR Rainfall=5.65"

Area (sf)	CN	Description
8,412	55	Woods, Good, HSG B
44,689	70	Woods, Good, HSG C
4,740	65	Brush, Good, HSG C
57,841	67	Weighted Average
57,841		100.00% Pervious Area

Tc (min)	Length (feet)	Slope (ft/ft)	Velocity (ft/sec)	Capacity (cfs)	Description
25.8	100	0.0500	0.06		Sheet Flow, Sheet Flow Woods: Dense underbrush n= 0.800 P2= 3.23"
3.9	274	0.0550	1.17		Shallow Concentrated Flow, Shallow Channel Woodland Kv= 5.0 fps
29.7	374	Total			

Summary for Subcatchment ES07: ES-07

Runoff = 1.6 cfs @ 12.40 hrs, Volume= 8,597 cf, Depth> 2.43"

Runoff by SCS TR-20 method, UH=SCS, Weighted-CN, Time Span= 0.00-24.00 hrs, dt= 0.06 hrs
Type III 24-hr 10-YR Rainfall=5.65"

Area (sf)	CN	Description
37,671	70	Woods, Good, HSG C
4,832	65	Brush, Good, HSG C
42,503	69	Weighted Average
42,503		100.00% Pervious Area

Tc (min)	Length (feet)	Slope (ft/ft)	Velocity (ft/sec)	Capacity (cfs)	Description
24.0	100	0.0600	0.07		Sheet Flow, Sheet Flow Woods: Dense underbrush n= 0.800 P2= 3.23"
3.5	150	0.0200	0.71		Shallow Concentrated Flow, Shallow Channel Woodland Kv= 5.0 fps
27.5	250	Total			

Summary for Subcatchment ES08: ES-08

Runoff = 6.6 cfs @ 12.51 hrs, Volume= 39,407 cf, Depth> 2.34"

Runoff by SCS TR-20 method, UH=SCS, Weighted-CN, Time Span= 0.00-24.00 hrs, dt= 0.06 hrs
Type III 24-hr 10-YR Rainfall=5.65"

477361-00_PRE-&POST_2020-04-20

Prepared by {enter your company name here}

HydroCAD® 10.10-3a s/n 00866 © 2020 HydroCAD Software Solutions LLC

Pre-Development - 10yr
Type III 24-hr 10-YR Rainfall=5.65"

Printed 4/28/2020

Page 5

Area (sf)	CN	Description
15,357	55	Woods, Good, HSG B
3	48	Brush, Good, HSG B
137,613	70	Woods, Good, HSG C
43,258	65	Brush, Good, HSG C
6,197	65	Power Line - Brush, Good, HSG C
202,428	68	Weighted Average
202,428		100.00% Pervious Area

Tc (min)	Length (feet)	Slope (ft/ft)	Velocity (ft/sec)	Capacity (cfs)	Description
25.8	100	0.0500	0.06		Sheet Flow, Sheet Flow Woods: Dense underbrush n= 0.800 P2= 3.23"
8.7	505	0.0378	0.97		Shallow Concentrated Flow, Shallow Channel Woodland Kv= 5.0 fps
0.4	90	0.0156	3.35	1,072.87	Channel Flow, Channel Flow Area= 320.0 sf Perim= 184.2' r= 1.74' n= 0.080 Earth, long dense weeds
34.9	695	Total			

Summary for Subcatchment ES09: ES-09

Runoff = 14.8 cfs @ 13.10 hrs, Volume= 143,476 cf, Depth> 1.66"

Runoff by SCS TR-20 method, UH=SCS, Weighted-CN, Time Span= 0.00-24.00 hrs, dt= 0.06 hrs
Type III 24-hr 10-YR Rainfall=5.65"

Area (sf)	CN	Description
582,972	55	Woods, Good, HSG B
1,726	48	Brush, Good, HSG B
70,412	48	Power Line - Brush, Good, HSG B
316,309	70	Woods, Good, HSG C
27,337	65	Brush, Good, HSG C
39,193	65	Power Line - Brush, Good, HSG C
1,037,949	60	Weighted Average
1,037,949		100.00% Pervious Area

Tc (min)	Length (feet)	Slope (ft/ft)	Velocity (ft/sec)	Capacity (cfs)	Description
31.6	100	0.0300	0.05		Sheet Flow, Sheet Flow Woods: Dense underbrush n= 0.800 P2= 3.23"
15.1	808	0.0320	0.89		Shallow Concentrated Flow, Shallow Channel Woodland Kv= 5.0 fps
27.1	515	0.0040	0.32		Shallow Concentrated Flow, Shallow Channel Woodland Kv= 5.0 fps
2.1	412	0.0170	3.28	594.29	Channel Flow, Channel Flow Area= 181.4 sf Perim= 115.3' r= 1.57' n= 0.080 Earth, long dense weeds
75.9	1,835	Total			

Summary for Reach ER01: ER-01

Inflow Area = 501,780 sf, 0.00% Impervious, Inflow Depth > 1.35" for 10-YR event
Inflow = 4.8 cfs @ 13.43 hrs, Volume= 56,442 cf
Outflow = 4.5 cfs @ 13.70 hrs, Volume= 55,208 cf, Atten= 6%, Lag= 15.9 min

Routing by Dyn-Stor-Ind method, Time Span= 0.00-24.00 hrs, dt= 0.06 hrs / 2
Max. Velocity= 0.42 fps, Min. Travel Time= 21.1 min
Avg. Velocity = 0.24 fps, Avg. Travel Time= 36.7 min

Peak Storage= 5,651 cf @ 13.70 hrs
Average Depth at Peak Storage= 0.08' , Surface Width= 142.58'
Bank-Full Depth= 2.00' Flow Area= 470.0 sf, Capacity= 1,413.2 cfs

135.00' x 2.00' deep channel, n= 0.050 Scattered brush, heavy weeds
Side Slope Z-value= 50.0 ' / ' Top Width= 335.00'
Length= 537.0' Slope= 0.0065 ' / '
Inlet Invert= 26.50', Outlet Invert= 23.00'



Summary for Reach ER02: ER02

Inflow Area = 695,568 sf, 1.69% Impervious, Inflow Depth > 2.17" for 10-YR event
Inflow = 13.9 cfs @ 12.85 hrs, Volume= 125,703 cf
Outflow = 12.2 cfs @ 13.10 hrs, Volume= 122,960 cf, Atten= 12%, Lag= 15.0 min

Routing by Dyn-Stor-Ind method, Time Span= 0.00-24.00 hrs, dt= 0.06 hrs / 2
Max. Velocity= 0.49 fps, Min. Travel Time= 21.8 min
Avg. Velocity = 0.23 fps, Avg. Travel Time= 45.6 min

Peak Storage= 16,021 cf @ 13.10 hrs
Average Depth at Peak Storage= 0.22' , Surface Width= 125.94'
Bank-Full Depth= 2.00' Flow Area= 408.0 sf, Capacity= 703.8 cfs

104.00' x 2.00' deep channel, n= 0.080 Earth, long dense weeds
Side Slope Z-value= 50.0 ' / ' Top Width= 304.00'
Length= 635.0' Slope= 0.0058 ' / '
Inlet Invert= 25.70', Outlet Invert= 22.00'



Summary for Reach ER03: ER03

Inflow Area = 218,049 sf, 0.00% Impervious, Inflow Depth > 1.90" for 10-YR event
Inflow = 5.3 cfs @ 12.77 hrs, Volume= 34,464 cf
Outflow = 3.0 cfs @ 13.26 hrs, Volume= 33,187 cf, Atten= 42%, Lag= 29.4 min

Routing by Dyn-Stor-Ind method, Time Span= 0.00-24.00 hrs, dt= 0.06 hrs / 2
Max. Velocity= 0.42 fps, Min. Travel Time= 39.3 min
Avg. Velocity = 0.24 fps, Avg. Travel Time= 69.4 min

Peak Storage= 7,178 cf @ 13.26 hrs
Average Depth at Peak Storage= 0.07' , Surface Width= 109.15'
Bank-Full Depth= 2.00' Flow Area= 358.0 sf, Capacity= 1,122.7 cfs

104.00' x 2.00' deep channel, n= 0.080 Earth, long dense weeds
Side Slope Z-value= 50.0 25.0 '/' Top Width= 254.00'
Length= 981.0' Slope= 0.0180 '/'
Inlet Invert= 43.50', Outlet Invert= 25.80'



Summary for Reach ER04: ER-05

Inflow Area = 1,240,377 sf, 0.00% Impervious, Inflow Depth > 1.77" for 10-YR event
Inflow = 17.7 cfs @ 12.99 hrs, Volume= 182,883 cf
Outflow = 17.1 cfs @ 13.17 hrs, Volume= 179,807 cf, Atten= 4%, Lag= 11.1 min

Routing by Dyn-Stor-Ind method, Time Span= 0.00-24.00 hrs, dt= 0.06 hrs / 2
Max. Velocity= 0.70 fps, Min. Travel Time= 16.2 min
Avg. Velocity = 0.35 fps, Avg. Travel Time= 32.8 min

Peak Storage= 16,575 cf @ 13.17 hrs
Average Depth at Peak Storage= 0.16' , Surface Width= 150.78'
Bank-Full Depth= 3.00' Flow Area= 569.4 sf, Capacity= 2,431.4 cfs

146.00' x 3.00' deep channel, n= 0.080 Earth, long dense weeds
Side Slope Z-value= 17.0 12.2 '/' Top Width= 233.60'
Length= 682.0' Slope= 0.0161 '/'
Inlet Invert= 33.00', Outlet Invert= 22.00'

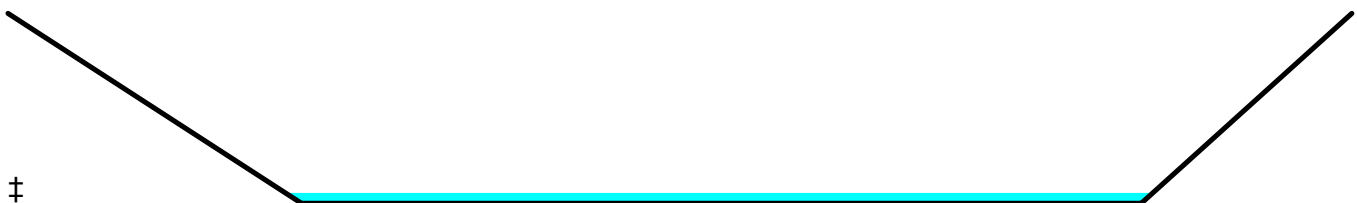

Summary for Pond EP01: CULVERT

[62] Hint: Exceeded Reach ER01 OUTLET depth by 2.69' @ 14.22 hrs
 [62] Hint: Exceeded Reach ER02 OUTLET depth by 3.62' @ 14.34 hrs
 [62] Hint: Exceeded Reach ER04 OUTLET depth by 3.65' @ 14.28 hrs

Inflow Area = 2,940,052 sf, 0.64% Impervious, Inflow Depth > 1.85" for 10-YR event
 Inflow = 39.3 cfs @ 13.05 hrs, Volume= 452,036 cf
 Outflow = 21.8 cfs @ 14.17 hrs, Volume= 451,376 cf, Atten= 44%, Lag= 67.3 min
 Primary = 21.8 cfs @ 14.17 hrs, Volume= 451,376 cf
 Secondary = 0.0 cfs @ 0.00 hrs, Volume= 0 cf

Routing by Dyn-Stor-Ind method, Time Span= 0.00-24.00 hrs, dt= 0.06 hrs / 2
 Peak Elev= 25.76' @ 14.17 hrs Surf.Area= 144,280 sf Storage= 83,762 cf

Plug-Flow detention time= 32.9 min calculated for 450,251 cf (100% of inflow)
 Center-of-Mass det. time= 32.1 min (950.8 - 918.7)

Volume	Invert	Avail.Storage	Storage Description			
#1	22.00'	349,966 cf	Custom Stage Data (Irregular) Listed below (Recalc)			
Elevation (feet)	Surf.Area (sq-ft)	Perim. (feet)	Inc.Store (cubic-feet)	Cum.Store (cubic-feet)	Wet.Area (sq-ft)	
22.00	10	40.0	0	0	10	
24.00	5,297	274.3	3,691	3,691	5,879	
25.00	33,326	789.9	17,303	20,995	49,546	
26.00	194,732	2,359.1	102,872	123,867	442,774	
27.00	258,992	2,650.0	226,100	349,966	558,757	

Device	Routing	Invert	Outlet Devices
#1	Primary	22.40'	15.0" Round RCP_Round 15" L= 33.5' RCP, groove end projecting, Ke= 0.200 Inlet / Outlet Invert= 22.40' / 22.35' S= 0.0015 '/ Cc= 0.900 n= 0.011 Concrete pipe, straight & clean, Flow Area= 1.23 sf
#2	Primary	22.40'	15.0" Round RCP_Round 15" L= 33.5' RCP, groove end projecting, Ke= 0.200 Inlet / Outlet Invert= 22.40' / 22.35' S= 0.0015 '/ Cc= 0.900 n= 0.011 Concrete pipe, straight & clean, Flow Area= 1.23 sf
#3	Secondary	25.93'	50.0' long x 20.0' breadth Broad-Crested Rectangular Weir Head (feet) 0.20 0.40 0.60 0.80 1.00 1.20 1.40 1.60 Coef. (English) 2.68 2.70 2.70 2.64 2.63 2.64 2.64 2.63

Primary OutFlow Max=21.8 cfs @ 14.17 hrs HW=25.76' TW=0.00' (Dynamic Tailwater)

↑1=RCP_Round 15" (Barrel Controls 10.9 cfs @ 8.90 fps)
 ↓2=RCP_Round 15" (Barrel Controls 10.9 cfs @ 8.90 fps)

Secondary OutFlow Max=0.0 cfs @ 0.00 hrs HW=22.00' TW=0.00' (Dynamic Tailwater)

↑3=Broad-Crested Rectangular Weir (Controls 0.0 cfs)

477361-00_PRE-&POST_2020-04-20

Prepared by {enter your company name here}

HydroCAD® 10.10-3a s/n 00866 © 2020 HydroCAD Software Solutions LLC

Pre-Development - 10yr
Type III 24-hr 10-YR Rainfall=5.65"

Printed 4/28/2020

Page 9

Summary for Pond EP02: EP02

Inflow Area = 218,049 sf, 0.00% Impervious, Inflow Depth > 2.33" for 10-YR event
 Inflow = 6.7 cfs @ 12.50 hrs, Volume= 42,324 cf
 Outflow = 5.3 cfs @ 12.77 hrs, Volume= 34,464 cf, Atten= 21%, Lag= 16.1 min
 Primary = 5.3 cfs @ 12.77 hrs, Volume= 34,464 cf

Routing by Dyn-Stor-Ind method, Time Span= 0.00-24.00 hrs, dt= 0.06 hrs / 2
 Peak Elev= 43.72' @ 12.78 hrs Surf.Area= 21,559 sf Storage= 11,287 cf

Plug-Flow detention time= 117.4 min calculated for 34,464 cf (81% of inflow)
 Center-of-Mass det. time= 44.3 min (913.8 - 869.5)

Volume	Invert	Avail.Storage	Storage Description			
#1	43.00'	17,987 cf	Custom Stage Data (Irregular) Listed below (Recalc)			
Elevation (feet)	Surf.Area (sq-ft)	Perim. (feet)	Inc.Store (cubic-feet)	Cum.Store (cubic-feet)	Wet.Area (sq-ft)	
43.00	10,339	760.4	0	0	10,339	
44.00	26,935	899.1	17,987	17,987	28,674	

Device	Routing	Invert	Outlet Devices								
#1	Primary	43.53'	25.0' long x 10.0' breadth Broad-Crested Rectangular Weir								
			Head (feet)	0.20	0.40	0.60	0.80	1.00	1.20	1.40	1.60
			Coef. (English)	2.49	2.56	2.70	2.69	2.68	2.69	2.67	2.64

Primary OutFlow Max=5.2 cfs @ 12.77 hrs HW=43.72' TW=43.54' (Dynamic Tailwater)
 ↳1=Broad-Crested Rectangular Weir (Weir Controls 5.2 cfs @ 1.09 fps)

Summary for Link EP01: Ex Pol-01

Inflow Area = 2,940,052 sf, 0.64% Impervious, Inflow Depth > 1.84" for 10-YR event
 Inflow = 21.8 cfs @ 14.17 hrs, Volume= 451,376 cf
 Primary = 21.8 cfs @ 14.17 hrs, Volume= 451,376 cf, Atten= 0%, Lag= 0.0 min

Primary outflow = Inflow, Time Span= 0.00-24.00 hrs, dt= 0.06 hrs

Summary for Link EP02: Ex Pol-02

Inflow Area = 57,405 sf, 0.00% Impervious, Inflow Depth > 1.75" for 10-YR event
 Inflow = 1.1 cfs @ 12.78 hrs, Volume= 8,366 cf
 Primary = 1.1 cfs @ 12.78 hrs, Volume= 8,366 cf, Atten= 0%, Lag= 0.0 min

Primary outflow = Inflow, Time Span= 0.00-24.00 hrs, dt= 0.06 hrs

Summary for Link EPol03: Proposed Wildlife Crossings

Inflow Area = 695,568 sf, 1.69% Impervious, Inflow Depth > 2.17" for 10-YR event
Inflow = 13.9 cfs @ 12.85 hrs, Volume= 125,703 cf
Primary = 13.9 cfs @ 12.85 hrs, Volume= 125,703 cf, Atten= 0%, Lag= 0.0 min

Primary outflow = Inflow, Time Span= 0.00-24.00 hrs, dt= 0.06 hrs

APPENDIX D
POST DRAINAGE

(This Page Is Intentionally Blank)

**POST DEVELOPMENT
DRAINAGE**

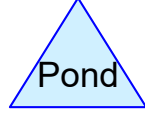
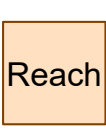
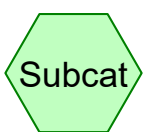
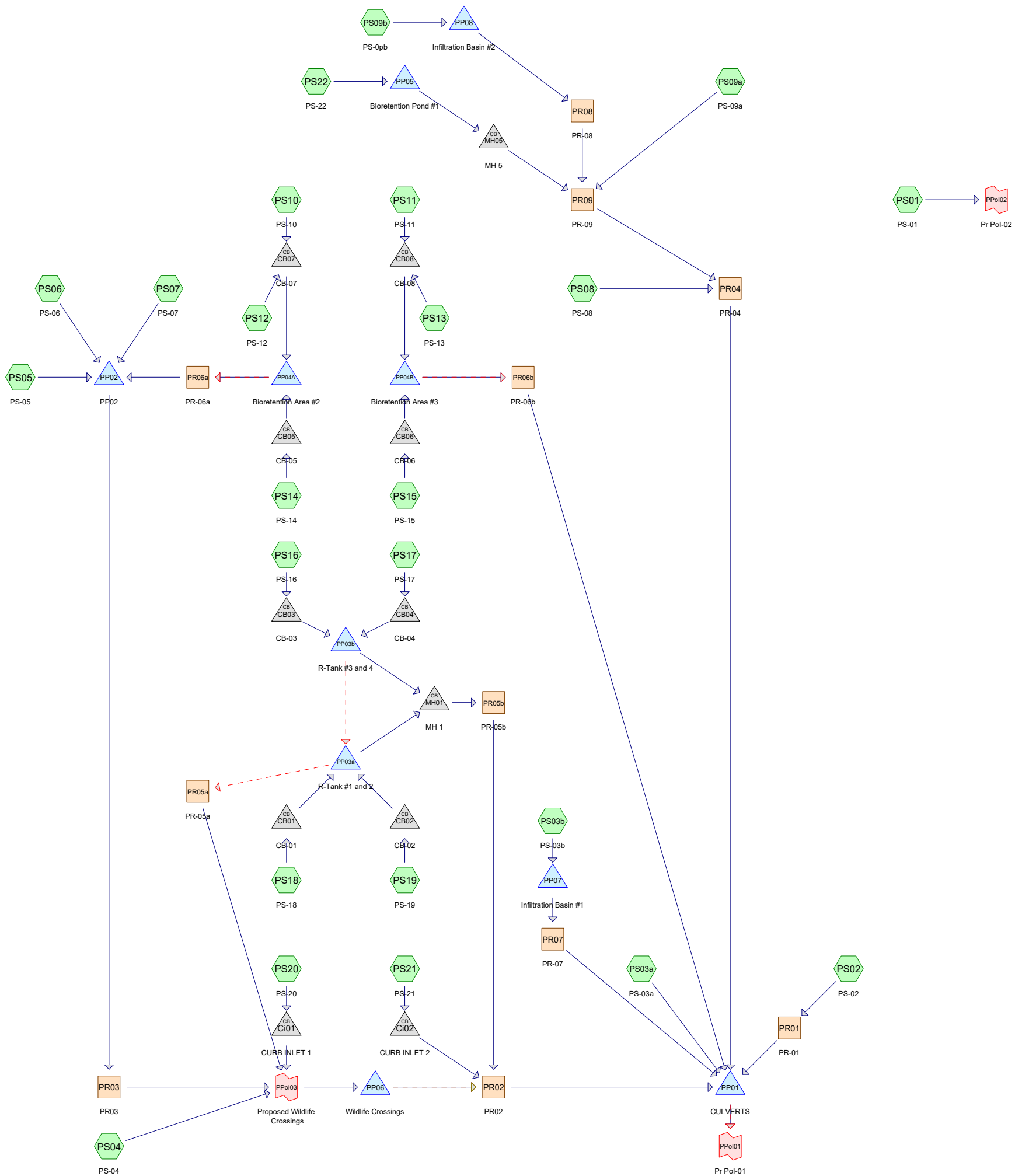

Routing Diagram for 477361-00_PRE-&-POST_2020-04-20
 Prepared by {enter your company name here}, Printed 4/28/2020
 HydroCAD® 10.10-3a s/n 00866 © 2020 HydroCAD Software Solutions LLC

(This Page Is Intentionally Blank)

477361-00_PRE-&-POST_2020-04-20

Prepared by {enter your company name here}

Printed 5/5/2020

HydroCAD® 10.10-3a s/n 00866 © 2020 HydroCAD Software Solutions LLC

Page 1

Area Listing (selected nodes)

Area (sq-ft)	CN	Description (subcatchment-numbers)
41,015	61	>75% Grass cover, Good, HSG B (PS03a, PS03b, PS05, PS06, PS08, PS09a, PS09b, PS10, PS11, PS12, PS13, PS17, PS18, PS19, PS22)
174,028	74	>75% Grass cover, Good, HSG C (PS03a, PS03b, PS04, PS05, PS06, PS07, PS08, PS09a, PS09b, PS10, PS11, PS12, PS13, PS14, PS15, PS16, PS17, PS18, PS19, PS20, PS21, PS22)
101,365	48	Brush, Good, HSG B (PS01, PS02, PS03a, PS09a)
618,870	65	Brush, Good, HSG C (PS01, PS02, PS03a, PS04, PS05, PS06, PS07, PS08, PS09a)
16,298	98	Paved parking, HSG B (PS03a, PS09a, PS10, PS11, PS12, PS13, PS17, PS18, PS19, PS20, PS21, PS22)
60,995	98	Paved parking, HSG C (PS03a, PS04, PS05, PS06, PS08, PS09a, PS10, PS11, PS12, PS13, PS14, PS15, PS16, PS17, PS18, PS19, PS20, PS21, PS22)
138,638	48	Power Line - Brush, Good, HSG B (PS01, PS02, PS03a, PS08, PS09a)
135,237	65	Power Line - Brush, Good, HSG C (PS01, PS02, PS03a, PS08, PS09a)
12,388	98	Roofs, HSG B (PS03a, PS03b, PS05, PS06, PS08, PS09a, PS09b, PS10, PS11, PS17, PS19)
28,996	98	Roofs, HSG C (PS03a, PS03b, PS04, PS05, PS06, PS07, PS08, PS09a, PS09b, PS10, PS11, PS14, PS16, PS17, PS18, PS19)
847,317	55	Woods, Good, HSG B (PS01, PS02, PS03a, PS04, PS05, PS06, PS08, PS09a, PS09b)
799,254	70	Woods, Good, HSG C (PS01, PS02, PS03a, PS04, PS05, PS06, PS07, PS08, PS09a, PS09b)
4,054	58	Woods/grass comb., Good, HSG B (PS06, PS12, PS13, PS18, PS19)
19,002	72	Woods/grass comb., Good, HSG C (PS03a, PS04, PS06, PS07, PS08, PS12, PS13, PS14, PS15, PS18, PS19, PS20, PS21)
2,997,457	64	TOTAL AREA

477361-00_PRE-&-POST_2020-04-20

Prepared by {enter your company name here}

Printed 5/5/2020

HydroCAD® 10.10-3a s/n 00866 © 2020 HydroCAD Software Solutions LLC

Page 2

Soil Listing (selected nodes)

Area (sq-ft)	Soil Group	Subcatchment Numbers
0	HSG A	
1,161,075	HSG B	PS01, PS02, PS03a, PS03b, PS04, PS05, PS06, PS08, PS09a, PS09b, PS10, PS11, PS12, PS13, PS17, PS18, PS19, PS20, PS21, PS22
1,836,382	HSG C	PS01, PS02, PS03a, PS03b, PS04, PS05, PS06, PS07, PS08, PS09a, PS09b, PS10, PS11, PS12, PS13, PS14, PS15, PS16, PS17, PS18, PS19, PS20, PS21, PS22
0	HSG D	
0	Other	
2,997,457		TOTAL AREA

477361-00_PRE-&POST_2020-04-20

Prepared by {enter your company name here}

HydroCAD® 10.10-3a s/n 00866 © 2020 HydroCAD Software Solutions LLC

Post Development

Type III 24-hr 2-YR Rainfall=3.73"

Printed 5/5/2020

Page 3

Time span=0.00-24.00 hrs, dt=0.06 hrs, 401 points x 2
 Runoff by SCS TR-20 method, UH=SCS, Weighted-CN
 Reach routing by Dyn-Stor-Ind method - Pond routing by Dyn-Stor-Ind method

Subcatchment PS01: PS-01	Runoff Area=57,405 sf 0.00% Impervious Runoff Depth>0.67" Flow Length=415' Tc=53.2 min CN=61 Runoff=0.3 cfs 3,189 cf
Subcatchment PS02: PS-02	Runoff Area=501,780 sf 0.00% Impervious Runoff Depth>0.45" Flow Length=740' Tc=95.8 min CN=56 Runoff=1.2 cfs 18,634 cf
Subcatchment PS03a: PS-03a	Runoff Area=477,793 sf 3.01% Impervious Runoff Depth>0.86" Flow Length=800' Tc=40.5 min CN=65 Runoff=4.8 cfs 34,434 cf
Subcatchment PS03b: PS-03b	Runoff Area=5,845 sf 18.63% Impervious Runoff Depth>1.60" Flow Length=55' Slope=0.0200 '/' Tc=6.0 min CN=77 Runoff=0.2 cfs 780 cf
Subcatchment PS04: PS-04	Runoff Area=460,441 sf 3.70% Impervious Runoff Depth>1.08" Flow Length=1,231' Tc=52.0 min CN=69 Runoff=5.3 cfs 41,377 cf
Subcatchment PS05: PS-05	Runoff Area=117,283 sf 8.10% Impervious Runoff Depth>1.26" Flow Length=375' Tc=41.3 min CN=72 Runoff=1.9 cfs 12,318 cf
Subcatchment PS06: PS-06	Runoff Area=63,674 sf 8.10% Impervious Runoff Depth>1.27" Flow Length=337' Tc=16.9 min CN=72 Runoff=1.5 cfs 6,733 cf
Subcatchment PS07: PS-07	Runoff Area=32,586 sf 5.06% Impervious Runoff Depth>1.20" Flow Length=316' Tc=28.1 min CN=71 Runoff=0.6 cfs 3,269 cf
Subcatchment PS08: PS-08	Runoff Area=155,960 sf 3.58% Impervious Runoff Depth>1.15" Flow Length=599' Tc=13.3 min CN=70 Runoff=3.5 cfs 14,937 cf
Subcatchment PS09a: PS-09a	Runoff Area=993,860 sf 0.73% Impervious Runoff Depth>0.62" Flow Length=1,835' Tc=75.9 min CN=60 Runoff=4.4 cfs 50,992 cf
Subcatchment PS09b: PS-09b	Runoff Area=14,865 sf 8.98% Impervious Runoff Depth>1.26" Flow Length=800' Tc=40.5 min CN=72 Runoff=0.2 cfs 1,562 cf
Subcatchment PS10: PS-10	Runoff Area=32,468 sf 52.74% Impervious Runoff Depth>2.21" Flow Length=483' Tc=13.2 min CN=85 Runoff=1.5 cfs 5,988 cf
Subcatchment PS11: PS-11	Runoff Area=12,159 sf 58.76% Impervious Runoff Depth>2.22" Flow Length=452' Tc=7.5 min CN=85 Runoff=0.7 cfs 2,245 cf
Subcatchment PS12: PS-12	Runoff Area=4,911 sf 36.61% Impervious Runoff Depth>1.60" Flow Length=139' Tc=5.0 min CN=77 Runoff=0.2 cfs 656 cf
Subcatchment PS13: PS-13	Runoff Area=4,559 sf 39.96% Impervious Runoff Depth>1.97" Flow Length=139' Tc=5.0 min CN=82 Runoff=0.2 cfs 750 cf
Subcatchment PS14: PS-14	Runoff Area=5,051 sf 20.97% Impervious Runoff Depth>1.67" Flow Length=96' Tc=5.0 min CN=78 Runoff=0.2 cfs 704 cf

477361-00_PRE-&-POST_2020-04-20

Prepared by {enter your company name here}

HydroCAD® 10.10-3a s/n 00866 © 2020 HydroCAD Software Solutions LLC

Post Development

Type III 24-hr 2-YR Rainfall=3.73"

Printed 5/5/2020

Page 4

Subcatchment PS15: PS-15	Runoff Area=4,235 sf 19.50% Impervious Runoff Depth>1.67" Flow Length=96' Tc=5.0 min CN=78 Runoff=0.2 cfs 590 cf
Subcatchment PS16: PS-16	Runoff Area=8,958 sf 58.47% Impervious Runoff Depth>2.48" Flow Length=117' Tc=5.6 min CN=88 Runoff=0.6 cfs 1,850 cf
Subcatchment PS17: PS-17	Runoff Area=12,705 sf 47.10% Impervious Runoff Depth>2.13" Flow Length=166' Tc=7.3 min CN=84 Runoff=0.7 cfs 2,258 cf
Subcatchment PS18: PS-18	Runoff Area=7,913 sf 43.27% Impervious Runoff Depth>1.90" Flow Length=124' Tc=5.0 min CN=81 Runoff=0.4 cfs 1,250 cf
Subcatchment PS19: PS-19	Runoff Area=7,620 sf 43.87% Impervious Runoff Depth>1.90" Flow Length=164' Tc=5.0 min CN=81 Runoff=0.4 cfs 1,204 cf
Subcatchment PS20: PS-20	Runoff Area=3,773 sf 66.10% Impervious Runoff Depth>2.57" Flow Length=128' Tc=5.0 min CN=89 Runoff=0.3 cfs 808 cf
Subcatchment PS21: PS-21	Runoff Area=3,612 sf 69.10% Impervious Runoff Depth>2.66" Flow Length=124' Tc=5.0 min CN=90 Runoff=0.3 cfs 801 cf
Subcatchment PS22: PS-22	Runoff Area=8,001 sf 37.17% Impervious Runoff Depth>1.46" Flow Length=275' Tc=10.8 min CN=75 Runoff=0.3 cfs 976 cf
Reach PR01: PR-01	Avg. Flow Depth=0.03' Max Vel=0.25 fps Inflow=1.2 cfs 18,634 cf n=0.050 L=537.0' S=0.0065 '/' Capacity=1,413.2 cfs Outflow=1.0 cfs 18,085 cf
Reach PR02: PR02	Avg. Flow Depth=0.10' Max Vel=0.45 fps Inflow=5.6 cfs 67,834 cf n=0.050 L=668.0' S=0.0055 '/' Capacity=1,097.9 cfs Outflow=4.7 cfs 66,099 cf
Reach PR03: PR03	Avg. Flow Depth=0.04' Max Vel=0.29 fps Inflow=2.0 cfs 21,544 cf n=0.080 L=894.0' S=0.0187 '/' Capacity=1,142.3 cfs Outflow=1.2 cfs 20,717 cf
Reach PR04: PR-04	Avg. Flow Depth=0.07' Max Vel=0.40 fps Inflow=4.3 cfs 64,544 cf n=0.080 L=682.0' S=0.0161 '/' Capacity=2,431.4 cfs Outflow=4.0 cfs 62,989 cf
Reach PR05a: PR-05a	Avg. Flow Depth=0.00' Max Vel=0.00 fps Inflow=0.0 cfs 0 cf n=0.100 L=46.0' S=0.0152 '/' Capacity=106.1 cfs Outflow=0.0 cfs 0 cf
Reach PR05b: PR-05b	Avg. Flow Depth=0.02' Max Vel=0.18 fps Inflow=0.1 cfs 4,170 cf n=0.100 L=46.0' S=0.0326 '/' Capacity=155.3 cfs Outflow=0.1 cfs 4,149 cf
Reach PR06a: PR-06a	Avg. Flow Depth=0.06' Max Vel=0.15 fps Inflow=0.3 cfs 7,093 cf n=0.100 L=193.0' S=0.0047 '/' Capacity=58.7 cfs Outflow=0.3 cfs 7,006 cf
Reach PR06b: PR-06b	Avg. Flow Depth=0.00' Max Vel=0.14 fps Inflow=0.0 cfs 495 cf n=0.100 L=1,100.0' S=0.0182 '/' Capacity=565.3 cfs Outflow=0.0 cfs 387 cf
Reach PR07: PR-07	Avg. Flow Depth=0.00' Max Vel=0.19 fps Inflow=0.0 cfs 5 cf n=0.100 L=633.0' S=0.0300 '/' Capacity=726.3 cfs Outflow=0.0 cfs 5 cf

Reach PR08: PR-08	Avg. Flow Depth=0.00' Max Vel=0.00 fps Inflow=0.0 cfs 0 cf n=0.100 L=814.0' S=0.0354 '/ Capacity=788.5 cfs Outflow=0.0 cfs 0 cf
Reach PR09: PR-09	Avg. Flow Depth=0.09' Max Vel=0.47 fps Inflow=4.4 cfs 50,992 cf n=0.080 L=682.0' S=0.0161 '/ Capacity=992.5 cfs Outflow=3.9 cfs 49,606 cf
Pond CB01: CB-01	Peak Elev=32.58' Inflow=0.4 cfs 1,250 cf 12.0" Round Culvert n=0.013 L=18.0' S=0.0056 '/ Outflow=0.4 cfs 1,250 cf
Pond CB02: CB-02	Peak Elev=32.57' Inflow=0.4 cfs 1,204 cf 12.0" Round Culvert n=0.013 L=18.0' S=0.0056 '/ Outflow=0.4 cfs 1,204 cf
Pond CB03: CB-03	Peak Elev=41.38' Inflow=0.6 cfs 1,850 cf 12.0" Round Culvert n=0.013 L=42.0' S=0.0429 '/ Outflow=0.6 cfs 1,850 cf
Pond CB04: CB-04	Peak Elev=41.42' Inflow=0.7 cfs 2,258 cf 12.0" Round Culvert n=0.013 L=37.0' S=0.0486 '/ Outflow=0.7 cfs 2,258 cf
Pond CB05: CB-05	Peak Elev=47.41' Inflow=0.2 cfs 704 cf 6.0" Round Culvert n=0.013 L=15.0' S=0.0100 '/ Outflow=0.2 cfs 704 cf
Pond CB06: CB-06	Peak Elev=45.45' Inflow=0.2 cfs 590 cf 6.0" Round Culvert n=0.013 L=15.0' S=0.0100 '/ Outflow=0.2 cfs 590 cf
Pond CB07: CB-07	Peak Elev=50.20' Inflow=1.7 cfs 6,644 cf 12.0" Round Culvert n=0.013 L=114.0' S=0.0175 '/ Outflow=1.7 cfs 6,644 cf
Pond CB08: CB-08	Peak Elev=49.99' Inflow=0.9 cfs 2,994 cf 12.0" Round Culvert n=0.013 L=110.0' S=0.0318 '/ Outflow=0.9 cfs 2,994 cf
Pond Ci01: CURB INLET 1	Peak Elev=26.77' Inflow=0.3 cfs 808 cf Outflow=0.3 cfs 808 cf
Pond Ci02: CURB INLET 2	Peak Elev=26.77' Inflow=0.3 cfs 801 cf Outflow=0.3 cfs 801 cf
Pond MH01: MH 1	Peak Elev=28.66' Inflow=0.1 cfs 4,170 cf 12.0" Round Culvert n=0.012 L=91.0' S=0.0082 '/ Outflow=0.1 cfs 4,170 cf
Pond MH05: MH 5	Peak Elev=51.30' Inflow=0.0 cfs 0 cf 12.0" Round Culvert n=0.013 L=65.0' S=0.0523 '/ Outflow=0.0 cfs 0 cf
Pond PP01: CULVERTS	Peak Elev=23.99' Storage=3,629 cf Inflow=10.1 cfs 181,999 cf Primary=10.0 cfs 181,603 cf Secondary=0.0 cfs 0 cf Outflow=10.0 cfs 181,603 cf
Pond PP02: PP02	Peak Elev=43.63' Storage=9,379 cf Inflow=3.6 cfs 29,326 cf Outflow=2.0 cfs 21,544 cf
Pond PP03a: R-Tank #1 and 2	Peak Elev=32.32' Storage=1,359 cf Inflow=0.8 cfs 2,453 cf Primary=0.0 cfs 1,780 cf Secondary=0.0 cfs 0 cf Outflow=0.0 cfs 1,780 cf

477361-00_PRE-&-POST_2020-04-20

Prepared by {enter your company name here}

HydroCAD® 10.10-3a s/n 00866 © 2020 HydroCAD Software Solutions LLC

Post Development

Type III 24-hr 2-YR Rainfall=3.73"

Printed 5/5/2020

Page 6

Pond PP03b: R-Tank #3 and 4 Peak Elev=34.38' Storage=2,522 cf Inflow=1.2 cfs 4,107 cf
Primary=0.1 cfs 2,390 cf Secondary=0.0 cfs 0 cf Outflow=0.1 cfs 2,390 cf

Pond PP04A: Bioretention Area #2 Peak Elev=47.41' Storage=2,721 cf Inflow=1.8 cfs 7,348 cf
Primary=0.3 cfs 7,093 cf Secondary=0.0 cfs 0 cf Outflow=0.3 cfs 7,093 cf

Pond PP04B: Bioretention Area #3 Peak Elev=45.26' Storage=3,095 cf Inflow=1.1 cfs 3,585 cf
Primary=0.0 cfs 495 cf Secondary=0.0 cfs 0 cf Outflow=0.0 cfs 495 cf

Pond PP05: Bioretention Pond #1 Peak Elev=56.09' Storage=976 cf Inflow=0.3 cfs 976 cf
Outflow=0.0 cfs 0 cf

Pond PP06: Wildlife Crossings Peak Elev=26.32' Storage=131 cf Inflow=5.4 cfs 62,902 cf
Primary=5.4 cfs 62,851 cf Secondary=0.0 cfs 33 cf Tertiary=0.0 cfs 0 cf Outflow=5.4 cfs 62,884 cf

Pond PP07: Infiltration Basin #1 Peak Elev=45.50' Storage=573 cf Inflow=0.2 cfs 780 cf
Discarded=0.0 cfs 215 cf Primary=0.0 cfs 5 cf Outflow=0.0 cfs 220 cf

Pond PP08: Infiltration Basin #2 Peak Elev=63.91' Storage=1,133 cf Inflow=0.2 cfs 1,562 cf
Discarded=0.0 cfs 437 cf Primary=0.0 cfs 0 cf Outflow=0.0 cfs 437 cf

Link PPol01: Pr Pol-01 Inflow=10.0 cfs 181,603 cf
Primary=10.0 cfs 181,603 cf

Link PPol02: Pr Pol-02 Inflow=0.3 cfs 3,189 cf
Primary=0.3 cfs 3,189 cf

Link PPol03: Proposed Wildlife Crossings Inflow=5.4 cfs 62,902 cf
Primary=5.4 cfs 62,902 cf

Total Runoff Area = 2,997,457 sf Runoff Volume = 208,305 cf Average Runoff Depth = 0.83"
96.04% Pervious = 2,878,780 sf 3.96% Impervious = 118,677 sf

Time span=0.00-24.00 hrs, dt=0.06 hrs, 401 points x 2
Runoff by SCS TR-20 method, UH=SCS, Weighted-CN
Reach routing by Dyn-Stor-Ind method - Pond routing by Dyn-Stor-Ind method

Subcatchment PS01: PS-01	Runoff Area=57,405 sf 0.00% Impervious Runoff Depth>1.75" Flow Length=415' Tc=53.2 min CN=61 Runoff=1.1 cfs 8,366 cf
Subcatchment PS02: PS-02	Runoff Area=501,780 sf 0.00% Impervious Runoff Depth>1.35" Flow Length=740' Tc=95.8 min CN=56 Runoff=4.8 cfs 56,442 cf
Subcatchment PS03a: PS-03a	Runoff Area=477,793 sf 3.01% Impervious Runoff Depth>2.08" Flow Length=800' Tc=40.5 min CN=65 Runoff=12.8 cfs 82,776 cf
Subcatchment PS03b: PS-03b	Runoff Area=5,845 sf 18.63% Impervious Runoff Depth>3.17" Flow Length=55' Slope=0.0200 '/' Tc=6.0 min CN=77 Runoff=0.5 cfs 1,545 cf
Subcatchment PS04: PS-04	Runoff Area=460,441 sf 3.70% Impervious Runoff Depth>2.41" Flow Length=1,231' Tc=52.0 min CN=69 Runoff=12.7 cfs 92,551 cf
Subcatchment PS05: PS-05	Runoff Area=117,283 sf 8.10% Impervious Runoff Depth>2.68" Flow Length=375' Tc=41.3 min CN=72 Runoff=4.1 cfs 26,241 cf
Subcatchment PS06: PS-06	Runoff Area=63,674 sf 8.10% Impervious Runoff Depth>2.70" Flow Length=337' Tc=16.9 min CN=72 Runoff=3.3 cfs 14,329 cf
Subcatchment PS07: PS-07	Runoff Area=32,586 sf 5.06% Impervious Runoff Depth>2.60" Flow Length=316' Tc=28.1 min CN=71 Runoff=1.3 cfs 7,070 cf
Subcatchment PS08: PS-08	Runoff Area=155,960 sf 3.58% Impervious Runoff Depth>2.52" Flow Length=599' Tc=13.3 min CN=70 Runoff=8.3 cfs 32,799 cf
Subcatchment PS09a: PS-09a	Runoff Area=993,860 sf 0.73% Impervious Runoff Depth>1.66" Flow Length=1,835' Tc=75.9 min CN=60 Runoff=14.2 cfs 137,382 cf
Subcatchment PS09b: PS-09b	Runoff Area=14,865 sf 8.98% Impervious Runoff Depth>2.69" Flow Length=800' Tc=40.5 min CN=72 Runoff=0.5 cfs 3,327 cf
Subcatchment PS10: PS-10	Runoff Area=32,468 sf 52.74% Impervious Runoff Depth>3.97" Flow Length=483' Tc=13.2 min CN=85 Runoff=2.7 cfs 10,729 cf
Subcatchment PS11: PS-11	Runoff Area=12,159 sf 58.76% Impervious Runoff Depth>3.97" Flow Length=452' Tc=7.5 min CN=85 Runoff=1.2 cfs 4,022 cf
Subcatchment PS12: PS-12	Runoff Area=4,911 sf 36.61% Impervious Runoff Depth>3.17" Flow Length=139' Tc=5.0 min CN=77 Runoff=0.4 cfs 1,299 cf
Subcatchment PS13: PS-13	Runoff Area=4,559 sf 39.96% Impervious Runoff Depth>3.66" Flow Length=139' Tc=5.0 min CN=82 Runoff=0.4 cfs 1,392 cf
Subcatchment PS14: PS-14	Runoff Area=5,051 sf 20.97% Impervious Runoff Depth>3.27" Flow Length=96' Tc=5.0 min CN=78 Runoff=0.4 cfs 1,376 cf

Subcatchment PS15: PS-15	Runoff Area=4,235 sf 19.50% Impervious Runoff Depth>3.27" Flow Length=96' Tc=5.0 min CN=78 Runoff=0.4 cfs 1,154 cf
Subcatchment PS16: PS-16	Runoff Area=8,958 sf 58.47% Impervious Runoff Depth>4.29" Flow Length=117' Tc=5.6 min CN=88 Runoff=1.0 cfs 3,200 cf
Subcatchment PS17: PS-17	Runoff Area=12,705 sf 47.10% Impervious Runoff Depth>3.87" Flow Length=166' Tc=7.3 min CN=84 Runoff=1.2 cfs 4,093 cf
Subcatchment PS18: PS-18	Runoff Area=7,913 sf 43.27% Impervious Runoff Depth>3.56" Flow Length=124' Tc=5.0 min CN=81 Runoff=0.8 cfs 2,350 cf
Subcatchment PS19: PS-19	Runoff Area=7,620 sf 43.87% Impervious Runoff Depth>3.56" Flow Length=164' Tc=5.0 min CN=81 Runoff=0.7 cfs 2,263 cf
Subcatchment PS20: PS-20	Runoff Area=3,773 sf 66.10% Impervious Runoff Depth>4.39" Flow Length=128' Tc=5.0 min CN=89 Runoff=0.4 cfs 1,382 cf
Subcatchment PS21: PS-21	Runoff Area=3,612 sf 69.10% Impervious Runoff Depth>4.50" Flow Length=124' Tc=5.0 min CN=90 Runoff=0.4 cfs 1,355 cf
Subcatchment PS22: PS-22	Runoff Area=8,001 sf 37.17% Impervious Runoff Depth>2.98" Flow Length=275' Tc=10.8 min CN=75 Runoff=0.5 cfs 1,987 cf
Reach PR01: PR-01	Avg. Flow Depth=0.08' Max Vel=0.42 fps Inflow=4.8 cfs 56,442 cf n=0.050 L=537.0' S=0.0065 '/' Capacity=1,413.2 cfs Outflow=4.5 cfs 55,208 cf
Reach PR02: PR02	Avg. Flow Depth=0.20' Max Vel=0.71 fps Inflow=17.4 cfs 151,988 cf n=0.050 L=668.0' S=0.0055 '/' Capacity=1,097.9 cfs Outflow=16.0 cfs 149,522 cf
Reach PR03: PR03	Avg. Flow Depth=0.09' Max Vel=0.52 fps Inflow=7.5 cfs 52,737 cf n=0.080 L=894.0' S=0.0187 '/' Capacity=1,142.3 cfs Outflow=5.3 cfs 51,299 cf
Reach PR04: PR-04	Avg. Flow Depth=0.14' Max Vel=0.64 fps Inflow=14.5 cfs 168,655 cf n=0.080 L=682.0' S=0.0161 '/' Capacity=2,431.4 cfs Outflow=13.8 cfs 165,623 cf
Reach PR05a: PR-05a	Avg. Flow Depth=0.00' Max Vel=0.00 fps Inflow=0.0 cfs 0 cf n=0.100 L=46.0' S=0.0152 '/' Capacity=106.1 cfs Outflow=0.0 cfs 0 cf
Reach PR05b: PR-05b	Avg. Flow Depth=0.02' Max Vel=0.19 fps Inflow=0.1 cfs 5,451 cf n=0.100 L=46.0' S=0.0326 '/' Capacity=155.3 cfs Outflow=0.1 cfs 5,424 cf
Reach PR06a: PR-06a	Avg. Flow Depth=0.14' Max Vel=0.25 fps Inflow=1.6 cfs 13,152 cf n=0.100 L=193.0' S=0.0047 '/' Capacity=58.7 cfs Outflow=1.3 cfs 13,028 cf
Reach PR06b: PR-06b	Avg. Flow Depth=0.03' Max Vel=0.18 fps Inflow=0.5 cfs 3,463 cf n=0.100 L=1,100.0' S=0.0182 '/' Capacity=565.3 cfs Outflow=0.2 cfs 3,234 cf
Reach PR07: PR-07	Avg. Flow Depth=0.01' Max Vel=0.19 fps Inflow=0.2 cfs 736 cf n=0.100 L=633.0' S=0.0300 '/' Capacity=726.3 cfs Outflow=0.1 cfs 731 cf

Reach PR08: PR-08	Avg. Flow Depth=0.01' Max Vel=0.20 fps Inflow=0.1 cfs 703 cf n=0.100 L=814.0' S=0.0354 '/ Capacity=788.5 cfs Outflow=0.0 cfs 682 cf
Reach PR09: PR-09	Avg. Flow Depth=0.19' Max Vel=0.74 fps Inflow=14.2 cfs 138,064 cf n=0.080 L=682.0' S=0.0161 '/ Capacity=992.5 cfs Outflow=13.5 cfs 135,856 cf
Pond CB01: CB-01	Peak Elev=33.70' Inflow=0.8 cfs 2,350 cf 12.0" Round Culvert n=0.013 L=18.0' S=0.0056 '/ Outflow=0.8 cfs 2,350 cf
Pond CB02: CB-02	Peak Elev=33.70' Inflow=0.7 cfs 2,263 cf 12.0" Round Culvert n=0.013 L=18.0' S=0.0056 '/ Outflow=0.7 cfs 2,263 cf
Pond CB03: CB-03	Peak Elev=41.51' Inflow=1.0 cfs 3,200 cf 12.0" Round Culvert n=0.013 L=42.0' S=0.0429 '/ Outflow=1.0 cfs 3,200 cf
Pond CB04: CB-04	Peak Elev=41.58' Inflow=1.2 cfs 4,093 cf 12.0" Round Culvert n=0.013 L=37.0' S=0.0486 '/ Outflow=1.2 cfs 4,093 cf
Pond CB05: CB-05	Peak Elev=48.01' Inflow=0.4 cfs 1,376 cf 6.0" Round Culvert n=0.013 L=15.0' S=0.0100 '/ Outflow=0.4 cfs 1,376 cf
Pond CB06: CB-06	Peak Elev=45.60' Inflow=0.4 cfs 1,154 cf 6.0" Round Culvert n=0.013 L=15.0' S=0.0100 '/ Outflow=0.4 cfs 1,154 cf
Pond CB07: CB-07	Peak Elev=50.61' Inflow=3.0 cfs 12,028 cf 12.0" Round Culvert n=0.013 L=114.0' S=0.0175 '/ Outflow=3.0 cfs 12,028 cf
Pond CB08: CB-08	Peak Elev=50.18' Inflow=1.6 cfs 5,414 cf 12.0" Round Culvert n=0.013 L=110.0' S=0.0318 '/ Outflow=1.6 cfs 5,414 cf
Pond Ci01: CURB INLET 1	Peak Elev=26.80' Inflow=0.4 cfs 1,382 cf Outflow=0.4 cfs 1,382 cf
Pond Ci02: CURB INLET 2	Peak Elev=26.80' Inflow=0.4 cfs 1,355 cf Outflow=0.4 cfs 1,355 cf
Pond MH01: MH 1	Peak Elev=28.67' Inflow=0.1 cfs 5,451 cf 12.0" Round Culvert n=0.012 L=91.0' S=0.0082 '/ Outflow=0.1 cfs 5,451 cf
Pond MH05: MH 5	Peak Elev=51.30' Inflow=0.0 cfs 0 cf 12.0" Round Culvert n=0.013 L=65.0' S=0.0523 '/ Outflow=0.0 cfs 0 cf
Pond PP01: CULVERTS	Peak Elev=25.72' Storage=77,770 cf Inflow=36.1 cfs 457,094 cf Primary=21.6 cfs 456,403 cf Secondary=0.0 cfs 0 cf Outflow=21.6 cfs 456,403 cf
Pond PP02: PP02	Peak Elev=43.78' Storage=12,483 cf Inflow=8.4 cfs 60,668 cf Outflow=7.5 cfs 52,737 cf
Pond PP03a: R-Tank #1 and 2	Peak Elev=33.70' Storage=3,192 cf Inflow=1.5 cfs 4,987 cf Primary=0.1 cfs 2,435 cf Secondary=0.0 cfs 0 cf Outflow=0.1 cfs 2,435 cf

477361-00_PRE-&-POST_2020-04-20

Prepared by {enter your company name here}

HydroCAD® 10.10-3a s/n 00866 © 2020 HydroCAD Software Solutions LLC

Post Development

Type III 24-hr 10-YR Rainfall=5.65"

Printed 5/5/2020

Page 10

Pond PP03b: R-Tank #3 and 4 Peak Elev=36.11' Storage=4,778 cf Inflow=2.2 cfs 7,294 cf
Primary=0.1 cfs 3,016 cf Secondary=0.0 cfs 374 cf Outflow=0.1 cfs 3,390 cf

Pond PP04A: Bioretention Area #2 Peak Elev=48.00' Storage=4,346 cf Inflow=3.3 cfs 13,404 cf
Primary=1.6 cfs 13,152 cf Secondary=0.0 cfs 0 cf Outflow=1.6 cfs 13,152 cf

Pond PP04B: Bioretention Area #3 Peak Elev=45.39' Storage=3,420 cf Inflow=1.9 cfs 6,568 cf
Primary=0.5 cfs 3,463 cf Secondary=0.0 cfs 0 cf Outflow=0.5 cfs 3,463 cf

Pond PP05: Bioretention Pond #1 Peak Elev=56.80' Storage=1,986 cf Inflow=0.5 cfs 1,987 cf
Outflow=0.0 cfs 0 cf

Pond PP06: Wildlife Crossings Peak Elev=26.76' Storage=527 cf Inflow=17.3 cfs 145,232 cf
Primary=12.8 cfs 131,684 cf Secondary=4.5 cfs 13,525 cf Tertiary=0.0 cfs 0 cf Outflow=17.3 cfs 145,209 cf

Pond PP07: Infiltration Basin #1 Peak Elev=45.56' Storage=619 cf Inflow=0.5 cfs 1,545 cf
Discarded=0.0 cfs 236 cf Primary=0.2 cfs 736 cf Outflow=0.2 cfs 972 cf

Pond PP08: Infiltration Basin #2 Peak Elev=64.53' Storage=2,103 cf Inflow=0.5 cfs 3,327 cf
Discarded=0.0 cfs 559 cf Primary=0.1 cfs 703 cf Outflow=0.1 cfs 1,262 cf

Link PPol01: Pr Pol-01 Inflow=21.6 cfs 456,403 cf
Primary=21.6 cfs 456,403 cf

Link PPol02: Pr Pol-02 Inflow=1.1 cfs 8,366 cf
Primary=1.1 cfs 8,366 cf

Link PPol03: Proposed Wildlife Crossings Inflow=17.3 cfs 145,232 cf
Primary=17.3 cfs 145,232 cf

Total Runoff Area = 2,997,457 sf Runoff Volume = 499,433 cf Average Runoff Depth = 2.00"
96.04% Pervious = 2,878,780 sf 3.96% Impervious = 118,677 sf

Time span=0.00-24.00 hrs, dt=0.06 hrs, 401 points x 2
Runoff by SCS TR-20 method, UH=SCS, Weighted-CN
Reach routing by Dyn-Stor-Ind method - Pond routing by Dyn-Stor-Ind method

Subcatchment PS01: PS-01	Runoff Area=57,405 sf 0.00% Impervious Runoff Depth>2.78" Flow Length=415' Tc=53.2 min CN=61 Runoff=1.8 cfs 13,302 cf
Subcatchment PS02: PS-02	Runoff Area=501,780 sf 0.00% Impervious Runoff Depth>2.26" Flow Length=740' Tc=95.8 min CN=56 Runoff=8.5 cfs 94,422 cf
Subcatchment PS03a: PS-03a	Runoff Area=477,793 sf 3.01% Impervious Runoff Depth>3.20" Flow Length=800' Tc=40.5 min CN=65 Runoff=20.0 cfs 127,298 cf
Subcatchment PS03b: PS-03b	Runoff Area=5,845 sf 18.63% Impervious Runoff Depth>4.51" Flow Length=55' Slope=0.0200 '/' Tc=6.0 min CN=77 Runoff=0.7 cfs 2,195 cf
Subcatchment PS04: PS-04	Runoff Area=460,441 sf 3.70% Impervious Runoff Depth>3.60" Flow Length=1,231' Tc=52.0 min CN=69 Runoff=19.2 cfs 138,298 cf
Subcatchment PS05: PS-05	Runoff Area=117,283 sf 8.10% Impervious Runoff Depth>3.93" Flow Length=375' Tc=41.3 min CN=72 Runoff=6.1 cfs 38,434 cf
Subcatchment PS06: PS-06	Runoff Area=63,674 sf 8.10% Impervious Runoff Depth>3.95" Flow Length=337' Tc=16.9 min CN=72 Runoff=4.9 cfs 20,978 cf
Subcatchment PS07: PS-07	Runoff Area=32,586 sf 5.06% Impervious Runoff Depth>3.84" Flow Length=316' Tc=28.1 min CN=71 Runoff=2.0 cfs 10,419 cf
Subcatchment PS08: PS-08	Runoff Area=155,960 sf 3.58% Impervious Runoff Depth>3.74" Flow Length=599' Tc=13.3 min CN=70 Runoff=12.4 cfs 48,643 cf
Subcatchment PS09a: PS-09a	Runoff Area=993,860 sf 0.73% Impervious Runoff Depth>2.66" Flow Length=1,835' Tc=75.9 min CN=60 Runoff=23.8 cfs 220,570 cf
Subcatchment PS09b: PS-09b	Runoff Area=14,865 sf 8.98% Impervious Runoff Depth>3.93" Flow Length=800' Tc=40.5 min CN=72 Runoff=0.8 cfs 4,872 cf
Subcatchment PS10: PS-10	Runoff Area=32,468 sf 52.74% Impervious Runoff Depth>5.40" Flow Length=483' Tc=13.2 min CN=85 Runoff=3.6 cfs 14,598 cf
Subcatchment PS11: PS-11	Runoff Area=12,159 sf 58.76% Impervious Runoff Depth>5.40" Flow Length=452' Tc=7.5 min CN=85 Runoff=1.6 cfs 5,472 cf
Subcatchment PS12: PS-12	Runoff Area=4,911 sf 36.61% Impervious Runoff Depth>4.51" Flow Length=139' Tc=5.0 min CN=77 Runoff=0.6 cfs 1,845 cf
Subcatchment PS13: PS-13	Runoff Area=4,559 sf 39.96% Impervious Runoff Depth>5.06" Flow Length=139' Tc=5.0 min CN=82 Runoff=0.6 cfs 1,924 cf
Subcatchment PS14: PS-14	Runoff Area=5,051 sf 20.97% Impervious Runoff Depth>4.62" Flow Length=96' Tc=5.0 min CN=78 Runoff=0.6 cfs 1,944 cf

Subcatchment PS15: PS-15	Runoff Area=4,235 sf 19.50% Impervious Runoff Depth>4.62" Flow Length=96' Tc=5.0 min CN=78 Runoff=0.5 cfs 1,630 cf
Subcatchment PS16: PS-16	Runoff Area=8,958 sf 58.47% Impervious Runoff Depth>5.75" Flow Length=117' Tc=5.6 min CN=88 Runoff=1.3 cfs 4,289 cf
Subcatchment PS17: PS-17	Runoff Area=12,705 sf 47.10% Impervious Runoff Depth>5.29" Flow Length=166' Tc=7.3 min CN=84 Runoff=1.6 cfs 5,598 cf
Subcatchment PS18: PS-18	Runoff Area=7,913 sf 43.27% Impervious Runoff Depth>4.95" Flow Length=124' Tc=5.0 min CN=81 Runoff=1.0 cfs 3,265 cf
Subcatchment PS19: PS-19	Runoff Area=7,620 sf 43.87% Impervious Runoff Depth>4.95" Flow Length=164' Tc=5.0 min CN=81 Runoff=1.0 cfs 3,144 cf
Subcatchment PS20: PS-20	Runoff Area=3,773 sf 66.10% Impervious Runoff Depth>5.86" Flow Length=128' Tc=5.0 min CN=89 Runoff=0.6 cfs 1,843 cf
Subcatchment PS21: PS-21	Runoff Area=3,612 sf 69.10% Impervious Runoff Depth>5.98" Flow Length=124' Tc=5.0 min CN=90 Runoff=0.6 cfs 1,799 cf
Subcatchment PS22: PS-22	Runoff Area=8,001 sf 37.17% Impervious Runoff Depth>4.28" Flow Length=275' Tc=10.8 min CN=75 Runoff=0.8 cfs 2,856 cf
Reach PR01: PR-01	Avg. Flow Depth=0.11' Max Vel=0.54 fps Inflow=8.5 cfs 94,422 cf n=0.050 L=537.0' S=0.0065 '/' Capacity=1,413.2 cfs Outflow=8.2 cfs 92,827 cf
Reach PR02: PR02	Avg. Flow Depth=0.27' Max Vel=0.86 fps Inflow=29.1 cfs 228,043 cf n=0.050 L=668.0' S=0.0055 '/' Capacity=1,097.9 cfs Outflow=27.2 cfs 225,133 cf
Reach PR03: PR03	Avg. Flow Depth=0.14' Max Vel=0.65 fps Inflow=12.3 cfs 79,787 cf n=0.080 L=894.0' S=0.0187 '/' Capacity=1,142.3 cfs Outflow=9.7 cfs 77,958 cf
Reach PR04: PR-04	Avg. Flow Depth=0.20' Max Vel=0.80 fps Inflow=24.5 cfs 268,631 cf n=0.080 L=682.0' S=0.0161 '/' Capacity=2,431.4 cfs Outflow=23.7 cfs 265,007 cf
Reach PR05a: PR-05a	Avg. Flow Depth=0.03' Max Vel=0.19 fps Inflow=0.2 cfs 2,198 cf n=0.100 L=46.0' S=0.0152 '/' Capacity=106.1 cfs Outflow=0.2 cfs 2,198 cf
Reach PR05b: PR-05b	Avg. Flow Depth=0.02' Max Vel=0.20 fps Inflow=0.1 cfs 6,001 cf n=0.100 L=46.0' S=0.0326 '/' Capacity=155.3 cfs Outflow=0.1 cfs 5,972 cf
Reach PR06a: PR-06a	Avg. Flow Depth=0.21' Max Vel=0.31 fps Inflow=3.6 cfs 18,135 cf n=0.100 L=193.0' S=0.0047 '/' Capacity=58.7 cfs Outflow=2.6 cfs 17,991 cf
Reach PR06b: PR-06b	Avg. Flow Depth=0.05' Max Vel=0.26 fps Inflow=1.5 cfs 5,912 cf n=0.100 L=1,100.0' S=0.0182 '/' Capacity=565.3 cfs Outflow=0.4 cfs 5,618 cf
Reach PR07: PR-07	Avg. Flow Depth=0.02' Max Vel=0.21 fps Inflow=0.7 cfs 1,374 cf n=0.100 L=633.0' S=0.0300 '/' Capacity=726.3 cfs Outflow=0.2 cfs 1,362 cf

Reach PR08: PR-08 Avg. Flow Depth=0.02' Max Vel=0.22 fps Inflow=0.4 cfs 2,210 cf
n=0.100 L=814.0' S=0.0354 '/ Capacity=788.5 cfs Outflow=0.1 cfs 2,166 cf

Reach PR09: PR-09 Avg. Flow Depth=0.26' Max Vel=0.89 fps Inflow=23.9 cfs 222,736 cf
n=0.080 L=682.0' S=0.0161 '/ Capacity=992.5 cfs Outflow=23.0 cfs 219,988 cf

Pond CB01: CB-01 Peak Elev=34.01' Inflow=1.0 cfs 3,265 cf
12.0" Round Culvert n=0.013 L=18.0' S=0.0056 '/ Outflow=1.0 cfs 3,265 cf

Pond CB02: CB-02 Peak Elev=34.01' Inflow=1.0 cfs 3,144 cf
12.0" Round Culvert n=0.013 L=18.0' S=0.0056 '/ Outflow=1.0 cfs 3,144 cf

Pond CB03: CB-03 Peak Elev=41.60' Inflow=1.3 cfs 4,289 cf
12.0" Round Culvert n=0.013 L=42.0' S=0.0429 '/ Outflow=1.3 cfs 4,289 cf

Pond CB04: CB-04 Peak Elev=41.69' Inflow=1.6 cfs 5,598 cf
12.0" Round Culvert n=0.013 L=37.0' S=0.0486 '/ Outflow=1.6 cfs 5,598 cf

Pond CB05: CB-05 Peak Elev=48.21' Inflow=0.6 cfs 1,944 cf
6.0" Round Culvert n=0.013 L=15.0' S=0.0100 '/ Outflow=0.6 cfs 1,944 cf

Pond CB06: CB-06 Peak Elev=45.75' Inflow=0.5 cfs 1,630 cf
6.0" Round Culvert n=0.013 L=15.0' S=0.0100 '/ Outflow=0.5 cfs 1,630 cf

Pond CB07: CB-07 Peak Elev=51.11' Inflow=4.0 cfs 16,443 cf
12.0" Round Culvert n=0.013 L=114.0' S=0.0175 '/ Outflow=4.0 cfs 16,443 cf

Pond CB08: CB-08 Peak Elev=50.33' Inflow=2.2 cfs 7,396 cf
12.0" Round Culvert n=0.013 L=110.0' S=0.0318 '/ Outflow=2.2 cfs 7,396 cf

Pond Ci01: CURB INLET 1 Peak Elev=26.83' Inflow=0.6 cfs 1,843 cf
Outflow=0.6 cfs 1,843 cf

Pond Ci02: CURB INLET 2 Peak Elev=26.82' Inflow=0.6 cfs 1,799 cf
Outflow=0.6 cfs 1,799 cf

Pond MH01: MH 1 Peak Elev=28.68' Inflow=0.1 cfs 6,001 cf
12.0" Round Culvert n=0.012 L=91.0' S=0.0082 '/ Outflow=0.1 cfs 6,001 cf

Pond MH05: MH 5 Peak Elev=51.30' Inflow=0.0 cfs 0 cf
12.0" Round Culvert n=0.013 L=65.0' S=0.0523 '/ Outflow=0.0 cfs 0 cf

Pond PP01: CULVERTS Peak Elev=26.19' Storage=160,830 cf Inflow=63.0 cfs 717,245 cf
Primary=23.9 cfs 630,588 cf Secondary=17.3 cfs 85,713 cf Outflow=41.2 cfs 716,300 cf

Pond PP02: PP02 Peak Elev=43.88' Storage=14,779 cf Inflow=13.5 cfs 87,822 cf
Outflow=12.3 cfs 79,787 cf

Pond PP03a: R-Tank #1 and 2 Peak Elev=34.00' Storage=3,644 cf Inflow=2.1 cfs 8,332 cf
Primary=0.1 cfs 2,649 cf Secondary=0.2 cfs 2,198 cf Outflow=0.3 cfs 4,847 cf

477361-00_PRE-&-POST_2020-04-20

Prepared by {enter your company name here}

HydroCAD® 10.10-3a s/n 00866 © 2020 HydroCAD Software Solutions LLC

Post Development
Type III 24-hr 25-YR Rainfall=7.16"

Printed 5/5/2020

Page 14

Pond PP03b: R-Tank #3 and 4 Peak Elev=37.12' Storage=6,333 cf Inflow=2.9 cfs 9,887 cf
Primary=0.1 cfs 3,352 cf Secondary=0.1 cfs 1,923 cf Outflow=0.1 cfs 5,275 cf

Pond PP04A: Bioretention Area #2 Peak Elev=48.11' Storage=4,728 cf Inflow=4.4 cfs 18,386 cf
Primary=2.6 cfs 17,463 cf Secondary=0.9 cfs 672 cf Outflow=3.6 cfs 18,135 cf

Pond PP04B: Bioretention Area #3 Peak Elev=45.52' Storage=3,779 cf Inflow=2.6 cfs 9,026 cf
Primary=1.5 cfs 5,889 cf Secondary=0.1 cfs 23 cf Outflow=1.5 cfs 5,912 cf

Pond PP05: Bioretention Pond #1 Peak Elev=57.31' Storage=2,855 cf Inflow=0.8 cfs 2,856 cf
Outflow=0.0 cfs 0 cf

Pond PP06: Wildlife Crossings Peak Elev=27.04' Storage=1,013 cf Inflow=28.9 cfs 220,298 cf
Primary=18.4 cfs 185,928 cf Secondary=8.8 cfs 31,559 cf Tertiary=1.7 cfs 2,784 cf Outflow=28.9 cfs 220,271 cf

Pond PP07: Infiltration Basin #1 Peak Elev=45.63' Storage=669 cf Inflow=0.7 cfs 2,195 cf
Discarded=0.0 cfs 247 cf Primary=0.7 cfs 1,374 cf Outflow=0.7 cfs 1,621 cf

Pond PP08: Infiltration Basin #2 Peak Elev=64.59' Storage=2,212 cf Inflow=0.8 cfs 4,872 cf
Discarded=0.0 cfs 592 cf Primary=0.4 cfs 2,210 cf Outflow=0.4 cfs 2,802 cf

Link PPol01: Pr Pol-01 Inflow=41.2 cfs 716,300 cf
Primary=41.2 cfs 716,300 cf

Link PPol02: Pr Pol-02 Inflow=1.8 cfs 13,302 cf
Primary=1.8 cfs 13,302 cf

Link PPol03: Proposed Wildlife Crossings Inflow=28.9 cfs 220,298 cf
Primary=28.9 cfs 220,298 cf

Total Runoff Area = 2,997,457 sf Runoff Volume = 769,638 cf Average Runoff Depth = 3.08"
96.04% Pervious = 2,878,780 sf 3.96% Impervious = 118,677 sf

Time span=0.00-24.00 hrs, dt=0.06 hrs, 401 points x 2
Runoff by SCS TR-20 method, UH=SCS, Weighted-CN
Reach routing by Dyn-Stor-Ind method - Pond routing by Dyn-Stor-Ind method

Subcatchment PS01: PS-01	Runoff Area=57,405 sf 0.00% Impervious Runoff Depth>3.84" Flow Length=415' Tc=53.2 min CN=61 Runoff=2.5 cfs 18,392 cf
Subcatchment PS02: PS-02	Runoff Area=501,780 sf 0.00% Impervious Runoff Depth>3.22" Flow Length=740' Tc=95.8 min CN=56 Runoff=12.6 cfs 134,614 cf
Subcatchment PS03a: PS-03a	Runoff Area=477,793 sf 3.01% Impervious Runoff Depth>4.33" Flow Length=800' Tc=40.5 min CN=65 Runoff=27.4 cfs 172,427 cf
Subcatchment PS03b: PS-03b	Runoff Area=5,845 sf 18.63% Impervious Runoff Depth>5.80" Flow Length=55' Slope=0.0200 '/' Tc=6.0 min CN=77 Runoff=0.9 cfs 2,827 cf
Subcatchment PS04: PS-04	Runoff Area=460,441 sf 3.70% Impervious Runoff Depth>4.79" Flow Length=1,231' Tc=52.0 min CN=69 Runoff=25.6 cfs 183,980 cf
Subcatchment PS05: PS-05	Runoff Area=117,283 sf 8.10% Impervious Runoff Depth>5.17" Flow Length=375' Tc=41.3 min CN=72 Runoff=8.0 cfs 50,485 cf
Subcatchment PS06: PS-06	Runoff Area=63,674 sf 8.10% Impervious Runoff Depth>5.19" Flow Length=337' Tc=16.9 min CN=72 Runoff=6.4 cfs 27,548 cf
Subcatchment PS07: PS-07	Runoff Area=32,586 sf 5.06% Impervious Runoff Depth>5.06" Flow Length=316' Tc=28.1 min CN=71 Runoff=2.6 cfs 13,740 cf
Subcatchment PS08: PS-08	Runoff Area=155,960 sf 3.58% Impervious Runoff Depth>4.96" Flow Length=599' Tc=13.3 min CN=70 Runoff=16.4 cfs 64,403 cf
Subcatchment PS09a: PS-09a	Runoff Area=993,860 sf 0.73% Impervious Runoff Depth>3.70" Flow Length=1,835' Tc=75.9 min CN=60 Runoff=33.8 cfs 306,796 cf
Subcatchment PS09b: PS-09b	Runoff Area=14,865 sf 8.98% Impervious Runoff Depth>5.17" Flow Length=800' Tc=40.5 min CN=72 Runoff=1.0 cfs 6,400 cf
Subcatchment PS10: PS-10	Runoff Area=32,468 sf 52.74% Impervious Runoff Depth>6.76" Flow Length=483' Tc=13.2 min CN=85 Runoff=4.5 cfs 18,294 cf
Subcatchment PS11: PS-11	Runoff Area=12,159 sf 58.76% Impervious Runoff Depth>6.77" Flow Length=452' Tc=7.5 min CN=85 Runoff=2.0 cfs 6,858 cf
Subcatchment PS12: PS-12	Runoff Area=4,911 sf 36.61% Impervious Runoff Depth>5.81" Flow Length=139' Tc=5.0 min CN=77 Runoff=0.8 cfs 2,376 cf
Subcatchment PS13: PS-13	Runoff Area=4,559 sf 39.96% Impervious Runoff Depth>6.41" Flow Length=139' Tc=5.0 min CN=82 Runoff=0.8 cfs 2,435 cf
Subcatchment PS14: PS-14	Runoff Area=5,051 sf 20.97% Impervious Runoff Depth>5.93" Flow Length=96' Tc=5.0 min CN=78 Runoff=0.8 cfs 2,494 cf

Subcatchment PS15: PS-15	Runoff Area=4,235 sf 19.50% Impervious Runoff Depth>5.93" Flow Length=96' Tc=5.0 min CN=78 Runoff=0.7 cfs 2,091 cf
Subcatchment PS16: PS-16	Runoff Area=8,958 sf 58.47% Impervious Runoff Depth>7.13" Flow Length=117' Tc=5.6 min CN=88 Runoff=1.6 cfs 5,324 cf
Subcatchment PS17: PS-17	Runoff Area=12,705 sf 47.10% Impervious Runoff Depth>6.65" Flow Length=166' Tc=7.3 min CN=84 Runoff=2.0 cfs 7,038 cf
Subcatchment PS18: PS-18	Runoff Area=7,913 sf 43.27% Impervious Runoff Depth>6.29" Flow Length=124' Tc=5.0 min CN=81 Runoff=1.3 cfs 4,146 cf
Subcatchment PS19: PS-19	Runoff Area=7,620 sf 43.87% Impervious Runoff Depth>6.29" Flow Length=164' Tc=5.0 min CN=81 Runoff=1.3 cfs 3,993 cf
Subcatchment PS20: PS-20	Runoff Area=3,773 sf 66.10% Impervious Runoff Depth>7.25" Flow Length=128' Tc=5.0 min CN=89 Runoff=0.7 cfs 2,280 cf
Subcatchment PS21: PS-21	Runoff Area=3,612 sf 69.10% Impervious Runoff Depth>7.37" Flow Length=124' Tc=5.0 min CN=90 Runoff=0.7 cfs 2,219 cf
Subcatchment PS22: PS-22	Runoff Area=8,001 sf 37.17% Impervious Runoff Depth>5.56" Flow Length=275' Tc=10.8 min CN=75 Runoff=1.0 cfs 3,706 cf
Reach PR01: PR-01	Avg. Flow Depth=0.14' Max Vel=0.62 fps Inflow=12.6 cfs 134,614 cf n=0.050 L=537.0' S=0.0065 '/' Capacity=1,413.2 cfs Outflow=12.2 cfs 132,764 cf
Reach PR02: PR02	Avg. Flow Depth=0.33' Max Vel=0.97 fps Inflow=40.6 cfs 304,714 cf n=0.050 L=668.0' S=0.0055 '/' Capacity=1,097.9 cfs Outflow=38.5 cfs 301,432 cf
Reach PR03: PR03	Avg. Flow Depth=0.17' Max Vel=0.75 fps Inflow=16.7 cfs 106,399 cf n=0.080 L=894.0' S=0.0187 '/' Capacity=1,142.3 cfs Outflow=14.0 cfs 104,357 cf
Reach PR04: PR-04	Avg. Flow Depth=0.25' Max Vel=0.92 fps Inflow=35.0 cfs 372,085 cf n=0.080 L=682.0' S=0.0161 '/' Capacity=2,431.4 cfs Outflow=34.1 cfs 367,860 cf
Reach PR05a: PR-05a	Avg. Flow Depth=0.08' Max Vel=0.31 fps Inflow=0.9 cfs 5,639 cf n=0.100 L=46.0' S=0.0152 '/' Capacity=106.1 cfs Outflow=0.8 cfs 5,636 cf
Reach PR05b: PR-05b	Avg. Flow Depth=0.02' Max Vel=0.20 fps Inflow=0.1 cfs 6,299 cf n=0.100 L=46.0' S=0.0326 '/' Capacity=155.3 cfs Outflow=0.1 cfs 6,271 cf
Reach PR06a: PR-06a	Avg. Flow Depth=0.26' Max Vel=0.35 fps Inflow=5.0 cfs 22,905 cf n=0.100 L=193.0' S=0.0047 '/' Capacity=58.7 cfs Outflow=4.0 cfs 22,751 cf
Reach PR06b: PR-06b	Avg. Flow Depth=0.07' Max Vel=0.32 fps Inflow=2.8 cfs 8,262 cf n=0.100 L=1,100.0' S=0.0182 '/' Capacity=565.3 cfs Outflow=0.8 cfs 7,910 cf
Reach PR07: PR-07	Avg. Flow Depth=0.03' Max Vel=0.26 fps Inflow=0.8 cfs 1,996 cf n=0.100 L=633.0' S=0.0300 '/' Capacity=726.3 cfs Outflow=0.3 cfs 1,977 cf

Reach PR08: PR-08 Avg. Flow Depth=0.04' Max Vel=0.30 fps Inflow=0.8 cfs 3,708 cf
 n=0.100 L=814.0' S=0.0354 '/ Capacity=788.5 cfs Outflow=0.3 cfs 3,642 cf

Reach PR09: PR-09 Avg. Flow Depth=0.32' Max Vel=1.02 fps Inflow=34.1 cfs 310,918 cf
 n=0.080 L=682.0' S=0.0161 '/ Capacity=992.5 cfs Outflow=33.1 cfs 307,682 cf

Pond CB01: CB-01 Peak Elev=34.16' Inflow=1.3 cfs 4,146 cf
 12.0" Round Culvert n=0.013 L=18.0' S=0.0056 '/ Outflow=1.3 cfs 4,146 cf

Pond CB02: CB-02 Peak Elev=34.16' Inflow=1.3 cfs 3,993 cf
 12.0" Round Culvert n=0.013 L=18.0' S=0.0056 '/ Outflow=1.3 cfs 3,990 cf

Pond CB03: CB-03 Peak Elev=41.68' Inflow=1.6 cfs 5,324 cf
 12.0" Round Culvert n=0.013 L=42.0' S=0.0429 '/ Outflow=1.6 cfs 5,324 cf

Pond CB04: CB-04 Peak Elev=41.80' Inflow=2.0 cfs 7,038 cf
 12.0" Round Culvert n=0.013 L=37.0' S=0.0486 '/ Outflow=2.0 cfs 7,038 cf

Pond CB05: CB-05 Peak Elev=48.64' Inflow=0.8 cfs 2,494 cf
 6.0" Round Culvert n=0.013 L=15.0' S=0.0100 '/ Outflow=0.8 cfs 2,494 cf

Pond CB06: CB-06 Peak Elev=46.02' Inflow=0.7 cfs 2,091 cf
 6.0" Round Culvert n=0.013 L=15.0' S=0.0100 '/ Outflow=0.7 cfs 2,091 cf

Pond CB07: CB-07 Peak Elev=51.72' Inflow=5.0 cfs 20,670 cf
 12.0" Round Culvert n=0.013 L=114.0' S=0.0175 '/ Outflow=5.0 cfs 20,670 cf

Pond CB08: CB-08 Peak Elev=50.49' Inflow=2.7 cfs 9,292 cf
 12.0" Round Culvert n=0.013 L=110.0' S=0.0318 '/ Outflow=2.7 cfs 9,292 cf

Pond Ci01: CURB INLET 1 Peak Elev=26.84' Inflow=0.7 cfs 2,280 cf
 Outflow=0.7 cfs 2,280 cf

Pond Ci02: CURB INLET 2 Peak Elev=26.84' Inflow=0.7 cfs 2,219 cf
 Outflow=0.7 cfs 2,219 cf

Pond MH01: MH 1 Peak Elev=28.68' Inflow=0.1 cfs 6,299 cf
 12.0" Round Culvert n=0.012 L=91.0' S=0.0082 '/ Outflow=0.1 cfs 6,299 cf

Pond MH05: MH 5 Peak Elev=51.38' Inflow=0.0 cfs 480 cf
 12.0" Round Culvert n=0.013 L=65.0' S=0.0523 '/ Outflow=0.0 cfs 480 cf

Pond PP01: CULVERTS Peak Elev=26.40' Storage=206,149 cf Inflow=90.9 cfs 984,370 cf
 Primary=24.8 cfs 728,245 cf Secondary=43.5 cfs 254,889 cf Outflow=68.3 cfs 983,135 cf

Pond PP02: PP02 Peak Elev=43.95' Storage=16,759 cf Inflow=18.2 cfs 114,524 cf
 Outflow=16.7 cfs 106,399 cf

Pond PP03a: R-Tank #1 and 2 Peak Elev=34.16' Storage=3,879 cf Inflow=2.6 cfs 11,927 cf
 Primary=0.1 cfs 2,748 cf Secondary=0.9 cfs 5,639 cf Outflow=0.9 cfs 8,388 cf

477361-00_PRE-&-POST_2020-04-20

Prepared by {enter your company name here}

HydroCAD® 10.10-3a s/n 00866 © 2020 HydroCAD Software Solutions LLC

Post Development
Type III 24-hr 50-YR Rainfall=8.58"

Printed 5/5/2020

Page 18

Pond PP03b: R-Tank #3 and 4 Peak Elev=37.48' Storage=6,879 cf Inflow=3.6 cfs 12,362 cf
Primary=0.1 cfs 3,551 cf Secondary=0.6 cfs 3,791 cf Outflow=0.6 cfs 7,342 cf

Pond PP04A: Bioretention Area #2 Peak Elev=48.20' Storage=5,009 cf Inflow=5.5 cfs 23,165 cf
Primary=2.9 cfs 20,957 cf Secondary=2.1 cfs 1,948 cf Outflow=5.0 cfs 22,905 cf

Pond PP04B: Bioretention Area #3 Peak Elev=45.60' Storage=3,987 cf Inflow=3.3 cfs 11,384 cf
Primary=2.1 cfs 7,838 cf Secondary=0.7 cfs 424 cf Outflow=2.8 cfs 8,262 cf

Pond PP05: Bioretention Pond #1 Peak Elev=57.52' Storage=3,240 cf Inflow=1.0 cfs 3,706 cf
Outflow=0.0 cfs 480 cf

Pond PP06: Wildlife Crossings Peak Elev=27.26' Storage=1,676 cf Inflow=40.4 cfs 296,254 cf
Primary=23.2 cfs 236,040 cf Secondary=12.7 cfs 50,617 cf Tertiary=4.5 cfs 9,567 cf Outflow=40.4 cfs 296,224 cf

Pond PP07: Infiltration Basin #1 Peak Elev=45.65' Storage=686 cf Inflow=0.9 cfs 2,827 cf
Discarded=0.0 cfs 256 cf Primary=0.8 cfs 1,996 cf Outflow=0.8 cfs 2,252 cf

Pond PP08: Infiltration Basin #2 Peak Elev=64.65' Storage=2,315 cf Inflow=1.0 cfs 6,400 cf
Discarded=0.0 cfs 617 cf Primary=0.8 cfs 3,708 cf Outflow=0.8 cfs 4,325 cf

Link PPol01: Pr Pol-01 Inflow=68.3 cfs 983,135 cf
Primary=68.3 cfs 983,135 cf

Link PPol02: Pr Pol-02 Inflow=2.5 cfs 18,392 cf
Primary=2.5 cfs 18,392 cf

Link PPol03: Proposed Wildlife Crossings Inflow=40.4 cfs 296,254 cf
Primary=40.4 cfs 296,254 cf

Total Runoff Area = 2,997,457 sf Runoff Volume = 1,044,870 cf Average Runoff Depth = 4.18"
96.04% Pervious = 2,878,780 sf 3.96% Impervious = 118,677 sf

APPENDIX E
POST DRAINAGE
(10 Yr Storm Event)

(This Page Is Intentionally Blank)

477361-00_PRE-&POST_2020-04-20

Prepared by {enter your company name here}
 HydroCAD® 10.10-3a s/n 00866 © 2020 HydroCAD Software Solutions LLC

Summary for Subcatchment PS01: PS-01

Runoff = 1.1 cfs @ 12.78 hrs, Volume= 8,366 cf, Depth> 1.75"

Runoff by SCS TR-20 method, UH=SCS, Weighted-CN, Time Span= 0.00-24.00 hrs, dt= 0.06 hrs
 Type III 24-hr 10-YR Rainfall=5.65"

Area (sf)	CN	Description
9,442	55	Woods, Good, HSG B
122	48	Brush, Good, HSG B
13,602	48	Power Line - Brush, Good, HSG B
16,200	70	Woods, Good, HSG C
7,778	65	Brush, Good, HSG C
10,261	65	Power Line - Brush, Good, HSG C
57,405	61	Weighted Average
57,405		100.00% Pervious Area

Tc (min)	Length (feet)	Slope (ft/ft)	Velocity (ft/sec)	Capacity (cfs)	Description
49.1	100	0.0100	0.03		Sheet Flow, Sheet-Flow Woods: Dense underbrush n= 0.800 P2= 3.23"
3.4	205	0.0400	1.00		Shallow Concentrated Flow, Shallow Concentrated Woodland Kv= 5.0 fps
0.7	110	0.0100	2.68	374.84	Channel Flow, Channel Flow Area= 140.0 sf Perim= 80.9' r= 1.73' n= 0.080 Earth, long dense weeds
53.2	415	Total			

Summary for Subcatchment PS02: PS-02

Runoff = 4.8 cfs @ 13.43 hrs, Volume= 56,442 cf, Depth> 1.35"

Runoff by SCS TR-20 method, UH=SCS, Weighted-CN, Time Span= 0.00-24.00 hrs, dt= 0.06 hrs
 Type III 24-hr 10-YR Rainfall=5.65"

Area (sf)	CN	Description
209,453	55	Woods, Good, HSG B
82,831	48	Brush, Good, HSG B
53,777	48	Power Line - Brush, Good, HSG B
21,794	70	Woods, Good, HSG C
126,184	65	Brush, Good, HSG C
7,741	65	Power Line - Brush, Good, HSG C
501,780	56	Weighted Average
501,780		100.00% Pervious Area

Tc (min)	Length (feet)	Slope (ft/ft)	Velocity (ft/sec)	Capacity (cfs)	Description
37.2	100	0.0200	0.04		Sheet Flow, Shallow Woods: Dense underbrush n= 0.800 P2= 3.23"
58.0	550	0.0010	0.16		Shallow Concentrated Flow, Shallow Channel Woodland Kv= 5.0 fps
0.6	90	0.0100	2.41	714.05	Channel Flow, Concentrated Area= 296.0 sf Perim= 200.0' r= 1.48' n= 0.080 Earth, long dense weeds
95.8	740	Total			

Summary for Subcatchment PS03a: PS-03a

Runoff = 12.8 cfs @ 12.59 hrs, Volume= 82,776 cf, Depth> 2.08"

Runoff by SCS TR-20 method, UH=SCS, Weighted-CN, Time Span= 0.00-24.00 hrs, dt= 0.06 hrs
 Type III 24-hr 10-YR Rainfall=5.65"

Area (sf)	CN	Description
2,148	98	Paved parking, HSG B
2,102	98	Roofs, HSG B
6,298	61	>75% Grass cover, Good, HSG B
47,744	55	Woods, Good, HSG B
16,804	48	Brush, Good, HSG B
844	48	Power Line - Brush, Good, HSG B
8,479	98	Paved parking, HSG C
1,648	98	Roofs, HSG C
10,830	74	>75% Grass cover, Good, HSG C
75,358	70	Woods, Good, HSG C
232,548	65	Brush, Good, HSG C
71,845	65	Power Line - Brush, Good, HSG C
1,145	72	Woods/grass comb., Good, HSG C
477,793	65	Weighted Average
463,416		96.99% Pervious Area
14,377		3.01% Impervious Area

477361-00_PRE-&POST_2020-04-20

Prepared by {enter your company name here}
 HydroCAD® 10.10-3a s/n 00866 © 2020 HydroCAD Software Solutions LLC

Tc (min)	Length (feet)	Slope (ft/ft)	Velocity (ft/sec)	Capacity (cfs)	Description
28.2	100	0.0400	0.06		Sheet Flow, Sheet Flow Woods: Dense underbrush n= 0.800 P2= 3.23"
12.3	700	0.0360	0.95		Shallow Concentrated Flow, Shallow Flow Woodland Kv= 5.0 fps
40.5	800	Total			

Summary for Subcatchment PS03b: PS-03b

[49] Hint: Tc<2dt may require smaller dt

Runoff = 0.5 cfs @ 12.09 hrs, Volume= 1,545 cf, Depth> 3.17"

Runoff by SCS TR-20 method, UH=SCS, Weighted-CN, Time Span= 0.00-24.00 hrs, dt= 0.06 hrs
 Type III 24-hr 10-YR Rainfall=5.65"

Area (sf)	CN	Description
0	98	Paved parking, HSG B
507	98	Roofs, HSG B
694	61	>75% Grass cover, Good, HSG B
0	55	Woods, Good, HSG B
0	48	Brush, Good, HSG B
0	48	Power Line - Brush, Good, HSG B
0	98	Paved parking, HSG C
582	98	Roofs, HSG C
4,062	74	>75% Grass cover, Good, HSG C
0	70	Woods, Good, HSG C
0	65	Brush, Good, HSG C
0	65	Power Line - Brush, Good, HSG C
0	72	Woods/grass comb., Good, HSG C
5,845	77	Weighted Average
4,756		81.37% Pervious Area
1,089		18.63% Impervious Area

Tc (min)	Length (feet)	Slope (ft/ft)	Velocity (ft/sec)	Capacity (cfs)	Description
6.0	55	0.0200	0.15		Sheet Flow, Sheet Flow Grass: Short n= 0.150 P2= 3.23"

Summary for Subcatchment PS04: PS-04

Runoff = 12.7 cfs @ 12.74 hrs, Volume= 92,551 cf, Depth> 2.41"

Runoff by SCS TR-20 method, UH=SCS, Weighted-CN, Time Span= 0.00-24.00 hrs, dt= 0.06 hrs
 Type III 24-hr 10-YR Rainfall=5.65"

Area (sf)	CN	Description
0	98	Paved parking, HSG B
0	98	Roofs, HSG B
0	61	>75% Grass cover, Good, HSG B
18,261	55	Woods, Good, HSG B
0	48	Brush, Good, HSG B
0	48	Power Line - Brush, Good, HSG B
13,586	98	Paved parking, HSG C
3,431	98	Roofs, HSG C
19,621	74	>75% Grass cover, Good, HSG C
248,714	70	Woods, Good, HSG C
154,834	65	Brush, Good, HSG C
1,994	72	Woods/grass comb., Good, HSG C
460,441	69	Weighted Average
443,424		96.30% Pervious Area
17,017		3.70% Impervious Area

Tc (min)	Length (feet)	Slope (ft/ft)	Velocity (ft/sec)	Capacity (cfs)	Description
37.2	100	0.0200	0.04		Sheet Flow, Sheet Flow Woods: Dense underbrush n= 0.800 P2= 3.23"
9.7	421	0.0210	0.72		Shallow Concentrated Flow, Shallow Flow Woodland Kv= 5.0 fps
5.1	710	0.0100	2.34	835.95	Channel Flow, Channel Flow Area= 358.0 sf Perim= 254.0' r= 1.41' n= 0.080 Earth, long dense weeds
52.0	1,231	Total			

Summary for Subcatchment PS05: PS-05

Runoff = 4.1 cfs @ 12.58 hrs, Volume= 26,241 cf, Depth> 2.68"

Runoff by SCS TR-20 method, UH=SCS, Weighted-CN, Time Span= 0.00-24.00 hrs, dt= 0.06 hrs
 Type III 24-hr 10-YR Rainfall=5.65"

477361-00_PRE-&POST_2020-04-20

Prepared by {enter your company name here}
 HydroCAD® 10.10-3a s/n 00866 © 2020 HydroCAD Software Solutions LLC

Area (sf)	CN	Description
0	98	Paved parking, HSG B
1,372	98	Roofs, HSG B
6,689	61	>75% Grass cover, Good, HSG B
1,161	55	Woods, Good, HSG B
0	48	Brush, Good, HSG B
2,910	98	Paved parking, HSG C
5,221	98	Roofs, HSG C
31,592	74	>75% Grass cover, Good, HSG C
50,975	70	Woods, Good, HSG C
17,363	65	Brush, Good, HSG C
117,283	72	Weighted Average
107,780		91.90% Pervious Area
9,503		8.10% Impervious Area

Tc (min)	Length (feet)	Slope (ft/ft)	Velocity (ft/sec)	Capacity (cfs)	Description
37.2	100	0.0200	0.04		Sheet Flow, Sheet Flow Woods: Dense underbrush n= 0.800 P2= 3.23"
4.1	275	0.0500	1.12		Shallow Concentrated Flow, Shallow Channel Woodland Kv= 5.0 fps
41.3	375	Total			

Summary for Subcatchment PS06: PS-06

Runoff = 3.3 cfs @ 12.24 hrs, Volume= 14,329 cf, Depth> 2.70"

Runoff by SCS TR-20 method, UH=SCS, Weighted-CN, Time Span= 0.00-24.00 hrs, dt= 0.06 hrs
 Type III 24-hr 10-YR Rainfall=5.65"

Area (sf)	CN	Description
0	98	Paved parking, HSG B
244	98	Roofs, HSG B
3,297	61	>75% Grass cover, Good, HSG B
4,211	55	Woods, Good, HSG B
539	58	Woods/grass comb., Good, HSG B
1,904	98	Paved parking, HSG C
3,008	98	Roofs, HSG C
20,224	74	>75% Grass cover, Good, HSG C
22,797	70	Woods, Good, HSG C
4,735	65	Brush, Good, HSG C
2,715	72	Woods/grass comb., Good, HSG C
63,674	72	Weighted Average
58,518		91.90% Pervious Area
5,156		8.10% Impervious Area

Tc (min)	Length (feet)	Slope (ft/ft)	Velocity (ft/sec)	Capacity (cfs)	Description
12.9	100	0.0100	0.13		Sheet Flow, Sheet Flow Grass: Short n= 0.150 P2= 3.23"
3.9	237	0.0400	1.00		Shallow Concentrated Flow, Shallow Channel Woodland Kv= 5.0 fps
16.9	337	Total			

Summary for Subcatchment PS07: PS-07

Runoff = 1.3 cfs @ 12.40 hrs, Volume= 7,070 cf, Depth> 2.60"

Runoff by SCS TR-20 method, UH=SCS, Weighted-CN, Time Span= 0.00-24.00 hrs, dt= 0.06 hrs
 Type III 24-hr 10-YR Rainfall=5.65"

Area (sf)	CN	Description
0	98	Paved roads w/curbs & sewers, HSG C
1,648	98	Roofs, HSG C
6,087	74	>75% Grass cover, Good, HSG C
18,941	70	Woods, Good, HSG C
4,832	65	Brush, Good, HSG C
1,078	72	Woods/grass comb., Good, HSG C
32,586	71	Weighted Average
30,938		94.94% Pervious Area
1,648		5.06% Impervious Area

Tc (min)	Length (feet)	Slope (ft/ft)	Velocity (ft/sec)	Capacity (cfs)	Description
4.8	50	0.0300	0.17		Sheet Flow, Sheet Flow Grass: Short n= 0.150 P2= 3.23"
18.2	50	0.0300	0.05		Sheet Flow, Sheet Flow Woods: Dense underbrush n= 0.800 P2= 3.23"
5.1	216	0.0200	0.71		Shallow Concentrated Flow, Shallow Channel Woodland Kv= 5.0 fps
28.1	316	Total			

477361-00_PRE-&POST_2020-04-20

Prepared by {enter your company name here}
 HydroCAD® 10.10-3a s/n 00866 © 2020 HydroCAD Software Solutions LLC

Summary for Subcatchment PS08: PS-08

Runoff = 8.3 cfs @ 12.19 hrs, Volume= 32,799 cf, Depth> 2.52"

Runoff by SCS TR-20 method, UH=SCS, Weighted-CN, Time Span= 0.00-24.00 hrs, dt= 0.06 hrs
 Type III 24-hr 10-YR Rainfall=5.65"

Area (sf)	CN	Description
0	98	Paved parking, HSG B
154	98	Roofs, HSG B
772	61	>75% Grass cover, Good, HSG B
97	55	Woods, Good, HSG B
0	48	Brush, Good, HSG B
3	48	Power Line - Brush, Good, HSG B
574	98	Paved parking, HSG C
4,850	98	Roofs, HSG C
21,977	74	>75% Grass cover, Good, HSG C
75,234	70	Woods, Good, HSG C
43,259	65	Brush, Good, HSG C
6,197	65	Power Line - Brush, Good, HSG C
2,843	72	Woods/grass comb., Good, HSG C
155,960	70	Weighted Average
150,382		96.42% Pervious Area
5,578		3.58% Impervious Area

Tc (min)	Length (feet)	Slope (ft/ft)	Velocity (ft/sec)	Capacity (cfs)	Description
5.9	100	0.0700	0.28		Sheet Flow, Sheet Flow Grass: Short n= 0.150 P2= 3.23"
7.0	409	0.0378	0.97		Shallow Concentrated Flow, Shallow Channel Woodland Kv= 5.0 fps
0.4	90	0.0156	3.35	1,072.87	Channel Flow, Channel Flow Area= 320.0 sf Perim= 184.2' r= 1.74' n= 0.080 Earth, long dense weeds
13.3	599	Total			

Summary for Subcatchment PS09a: PS-09a

Runoff = 14.2 cfs @ 13.10 hrs, Volume= 137,382 cf, Depth> 1.66"

Runoff by SCS TR-20 method, UH=SCS, Weighted-CN, Time Span= 0.00-24.00 hrs, dt= 0.06 hrs
 Type III 24-hr 10-YR Rainfall=5.65"

Area (sf)	CN	Description
1,512	98	Paved parking, HSG B
2,718	98	Roofs, HSG B
7,603	61	>75% Grass cover, Good, HSG B
556,219	55	Woods, Good, HSG B
1,608	48	Brush, Good, HSG B
70,412	48	Power Line - Brush, Good, HSG B
332	98	Paved parking, HSG C
2,684	98	Roofs, HSG C
23,034	74	>75% Grass cover, Good, HSG C
261,208	70	Woods, Good, HSG C
27,337	65	Brush, Good, HSG C
39,193	65	Power Line - Brush, Good, HSG C
993,860	60	Weighted Average
986,614		99.27% Pervious Area
7,246		0.73% Impervious Area

Tc (min)	Length (feet)	Slope (ft/ft)	Velocity (ft/sec)	Capacity (cfs)	Description
31.6	100	0.0300	0.05		Sheet Flow, Sheet Flow Woods: Dense underbrush n= 0.800 P2= 3.23"
15.1	808	0.0320	0.89		Shallow Concentrated Flow, Shallow Channel Woodland Kv= 5.0 fps
27.1	515	0.0040	0.32		Shallow Concentrated Flow, Shallow Channel Woodland Kv= 5.0 fps
2.1	412	0.0170	3.28	594.29	Channel Flow, Channel Flow Area= 181.4 sf Perim= 115.3' r= 1.57' n= 0.080 Earth, long dense weeds
75.9	1,835	Total			

Summary for Subcatchment PS09b: PS-0pb

Runoff = 0.5 cfs @ 12.57 hrs, Volume= 3,327 cf, Depth> 2.69"

Runoff by SCS TR-20 method, UH=SCS, Weighted-CN, Time Span= 0.00-24.00 hrs, dt= 0.06 hrs
 Type III 24-hr 10-YR Rainfall=5.65"

477361-00_PRE-&POST_2020-04-20

Prepared by {enter your company name here}
 HydroCAD® 10.10-3a s/n 00866 © 2020 HydroCAD Software Solutions LLC

Area (sf)	CN	Description
0	98	Paved parking, HSG B
1,206	98	Roofs, HSG B
879	61	>75% Grass cover, Good, HSG B
729	55	Woods, Good, HSG B
0	48	Brush, Good, HSG B
0	48	Power Line - Brush, Good, HSG B
0	98	Paved parking, HSG C
129	98	Roofs, HSG C
3,889	74	>75% Grass cover, Good, HSG C
8,033	70	Woods, Good, HSG C
0	65	Brush, Good, HSG C
0	65	Power Line - Brush, Good, HSG C
0	72	Woods/grass comb., Good, HSG C
14,865	72	Weighted Average
13,530		91.02% Pervious Area
1,335		8.98% Impervious Area

Tc (min)	Length (feet)	Slope (ft/ft)	Velocity (ft/sec)	Capacity (cfs)	Description
28.2	100	0.0400	0.06		Sheet Flow, Sheet Flow Woods: Dense underbrush n= 0.800 P2= 3.23"
12.3	700	0.0360	0.95		Shallow Concentrated Flow, Shallow Flow Woodland Kv= 5.0 fps
40.5	800	Total			

Summary for Subcatchment PS10: PS-10

Runoff = 2.7 cfs @ 12.18 hrs, Volume= 10,729 cf, Depth> 3.97"

Runoff by SCS TR-20 method, UH=SCS, Weighted-CN, Time Span= 0.00-24.00 hrs, dt= 0.06 hrs
 Type III 24-hr 10-YR Rainfall=5.65"

Area (sf)	CN	Description
4,190	98	Paved parking, HSG B
2,107	98	Roofs, HSG B
3,848	61	>75% Grass cover, Good, HSG B
0	55	Woods, Good, HSG B
0	48	Brush, Good, HSG B
8,981	98	Paved parking, HSG C
1,847	98	Roofs, HSG C
11,495	74	>75% Grass cover, Good, HSG C
0	70	Woods, Good, HSG C
0	65	Brush, Good, HSG C
32,468	85	Weighted Average
15,343		47.26% Pervious Area
17,125		52.74% Impervious Area

Tc (min)	Length (feet)	Slope (ft/ft)	Velocity (ft/sec)	Capacity (cfs)	Description
12.9	100	0.0100	0.13		Sheet Flow, Sheet Flow Grass: Short n= 0.150 P2= 3.23"
0.3	383	0.0150	21.93	438.64	Channel Flow, Channel Flow Area= 20.0 sf Perim= 10.2' r= 1.96' n= 0.013 Asphalt, smooth
13.2	483	Total			

Summary for Subcatchment PS11: PS-11

Runoff = 1.2 cfs @ 12.11 hrs, Volume= 4,022 cf, Depth> 3.97"

Runoff by SCS TR-20 method, UH=SCS, Weighted-CN, Time Span= 0.00-24.00 hrs, dt= 0.06 hrs
 Type III 24-hr 10-YR Rainfall=5.65"

Area (sf)	CN	Description
2,472	98	Paved parking, HSG B
911	98	Roofs, HSG B
2,470	61	>75% Grass cover, Good, HSG B
0	55	Woods, Good, HSG B
0	48	Brush, Good, HSG B
2,828	98	Paved parking, HSG C
934	98	Roofs, HSG C
2,544	74	>75% Grass cover, Good, HSG C
0	70	Woods, Good, HSG C
0	65	Brush, Good, HSG C
12,159	85	Weighted Average
5,014		41.24% Pervious Area
7,145		58.76% Impervious Area

477361-00_PRE-&POST_2020-04-20

Prepared by {enter your company name here}
 HydroCAD® 10.10-3a s/n 00866 © 2020 HydroCAD Software Solutions LLC

Tc (min)	Length (feet)	Slope (ft/ft)	Velocity (ft/sec)	Capacity (cfs)	Description
7.2	69	0.0200	0.16		Sheet Flow, Sheet Flow Grass: Short n= 0.150 P2= 3.23"
0.3	383	0.0150	21.93	438.64	Channel Flow, Channel Flow Area= 20.0 sf Perim= 10.2' r= 1.96' n= 0.013 Asphalt, smooth
7.5	452	Total			

Summary for Subcatchment PS12: PS-12

[49] Hint: Tc<2dt may require smaller dt

Runoff = 0.4 cfs @ 12.08 hrs, Volume= 1,299 cf, Depth> 3.17"

Runoff by SCS TR-20 method, UH=SCS, Weighted-CN, Time Span= 0.00-24.00 hrs, dt= 0.06 hrs
 Type III 24-hr 10-YR Rainfall=5.65"

Area (sf)	CN	Description
791	98	Paved parking, HSG B
0	98	Roofs, HSG B
248	61	>75% Grass cover, Good, HSG B
1,545	58	Woods/grass comb., Good, HSG B
1,007	98	Paved parking, HSG C
0	98	Roofs, HSG C
269	74	>75% Grass cover, Good, HSG C
1,051	72	Woods/grass comb., Good, HSG C
4,911	77	Weighted Average
3,113		63.39% Pervious Area
1,798		36.61% Impervious Area

Tc (min)	Length (feet)	Slope (ft/ft)	Velocity (ft/sec)	Capacity (cfs)	Description
0.6	3	0.0200	0.08		Sheet Flow, Sheet Flow Grass: Short n= 0.150 P2= 3.23"
0.1	136	0.0100	17.91	358.14	Channel Flow, Channel Flow Area= 20.0 sf Perim= 10.2' r= 1.96' n= 0.013 Asphalt, smooth
4.3					Direct Entry, Min Tc of 5 Min
5.0	139	Total			

Summary for Subcatchment PS13: PS-13

[49] Hint: Tc<2dt may require smaller dt

Runoff = 0.4 cfs @ 12.07 hrs, Volume= 1,392 cf, Depth> 3.66"

Runoff by SCS TR-20 method, UH=SCS, Weighted-CN, Time Span= 0.00-24.00 hrs, dt= 0.06 hrs
 Type III 24-hr 10-YR Rainfall=5.65"

Area (sf)	CN	Description
565	98	Paved parking, HSG B
0	98	Roofs, HSG B
130	61	>75% Grass cover, Good, HSG B
133	58	Woods/grass comb., Good, HSG B
1,257	98	Paved parking, HSG C
0	98	Roofs, HSG C
518	74	>75% Grass cover, Good, HSG C
1,956	72	Woods/grass comb., Good, HSG C
4,559	82	Weighted Average
2,737		60.04% Pervious Area
1,822		39.96% Impervious Area

Tc (min)	Length (feet)	Slope (ft/ft)	Velocity (ft/sec)	Capacity (cfs)	Description
0.6	3	0.0200	0.08		Sheet Flow, Sheet Flow Grass: Short n= 0.150 P2= 3.23"
0.1	136	0.0100	17.91	358.14	Channel Flow, Channel Flow Area= 20.0 sf Perim= 10.2' r= 1.96' n= 0.013 Asphalt, smooth
4.3					Direct Entry, Min Tc of 5 Min
5.0	139	Total			

Summary for Subcatchment PS14: PS-14

[49] Hint: Tc<2dt may require smaller dt

Runoff = 0.4 cfs @ 12.08 hrs, Volume= 1,376 cf, Depth> 3.27"

Runoff by SCS TR-20 method, UH=SCS, Weighted-CN, Time Span= 0.00-24.00 hrs, dt= 0.06 hrs
 Type III 24-hr 10-YR Rainfall=5.65"

477361-00_PRE-&POST_2020-04-20

Prepared by {enter your company name here}
 HydroCAD® 10.10-3a s/n 00866 © 2020 HydroCAD Software Solutions LLC

Area (sf)	CN	Description
813	98	Paved parking, HSG C
246	98	Roofs, HSG C
1,636	74	>75% Grass cover, Good, HSG C
0	70	Woods, Good, HSG C
2,356	72	Woods/grass comb., Good, HSG C
5,051	78	Weighted Average
3,992		79.03% Pervious Area
1,059		20.97% Impervious Area

Tc (min)	Length (feet)	Slope (ft/ft)	Velocity (ft/sec)	Capacity (cfs)	Description
0.6	3	0.0200	0.08		Sheet Flow, Sheet Flow Grass: Short n= 0.150 P2= 3.23"
0.1	93	0.0100	17.91	358.14	Channel Flow, Channel Flow Area= 20.0 sf Perim= 10.2' r= 1.96' n= 0.013 Asphalt, smooth
4.3					Direct Entry, Min Tc of 5 Min
5.0	96	Total			

Summary for Subcatchment PS15: PS-15

[49] Hint: Tc<2dt may require smaller dt

Runoff = 0.4 cfs @ 12.08 hrs, Volume= 1,154 cf, Depth> 3.27"

Runoff by SCS TR-20 method, UH=SCS, Weighted-CN, Time Span= 0.00-24.00 hrs, dt= 0.06 hrs
 Type III 24-hr 10-YR Rainfall=5.65"

Area (sf)	CN	Description
826	98	Paved parking, HSG C
0	98	Roofs, HSG C
1,548	74	>75% Grass cover, Good, HSG C
0	70	Woods, Good, HSG C
1,861	72	Woods/grass comb., Good, HSG C
4,235	78	Weighted Average
3,409		80.50% Pervious Area
826		19.50% Impervious Area

Tc (min)	Length (feet)	Slope (ft/ft)	Velocity (ft/sec)	Capacity (cfs)	Description
0.6	3	0.0200	0.08		Sheet Flow, Sheet Flow Grass: Short n= 0.150 P2= 3.23"
0.1	93	0.0100	17.91	358.14	Channel Flow, Channel Flow Area= 20.0 sf Perim= 10.2' r= 1.96' n= 0.013 Asphalt, smooth
4.3					Direct Entry, Min Tc of 5 Min
5.0	96	Total			

Summary for Subcatchment PS16: PS-16

[49] Hint: Tc<2dt may require smaller dt

Runoff = 1.0 cfs @ 12.08 hrs, Volume= 3,200 cf, Depth> 4.29"

Runoff by SCS TR-20 method, UH=SCS, Weighted-CN, Time Span= 0.00-24.00 hrs, dt= 0.06 hrs
 Type III 24-hr 10-YR Rainfall=5.65"

Area (sf)	CN	Description
4,626	98	Paved parking, HSG C
612	98	Roofs, HSG C
3,720	74	>75% Grass cover, Good, HSG C
0	70	Woods, Good, HSG C
0	65	Brush, Good, HSG C
8,958	88	Weighted Average
3,720		41.53% Pervious Area
5,238		58.47% Impervious Area

Tc (min)	Length (feet)	Slope (ft/ft)	Velocity (ft/sec)	Capacity (cfs)	Description
5.6	50	0.0200	0.15		Sheet Flow, Sheet Flow Grass: Short n= 0.150 P2= 3.23"
0.0	67	0.0400	35.81	716.29	Channel Flow, Channel Flow Area= 20.0 sf Perim= 10.2' r= 1.96' n= 0.013 Asphalt, smooth
5.6	117	Total			

Summary for Subcatchment PS17: PS-17

Runoff = 1.2 cfs @ 12.11 hrs, Volume= 4,093 cf, Depth> 3.87"

Runoff by SCS TR-20 method, UH=SCS, Weighted-CN, Time Span= 0.00-24.00 hrs, dt= 0.06 hrs
 Type III 24-hr 10-YR Rainfall=5.65"

477361-00_PRE-&POST_2020-04-20

Prepared by {enter your company name here}
 HydroCAD® 10.10-3a s/n 00866 © 2020 HydroCAD Software Solutions LLC

Area (sf)	CN	Description
782	98	Paved parking, HSG B
754	98	Roofs, HSG B
1,392	61	>75% Grass cover, Good, HSG B
0	55	Woods, Good, HSG B
0	48	Brush, Good, HSG B
3,514	98	Paved parking, HSG C
934	98	Roofs, HSG C
5,329	74	>75% Grass cover, Good, HSG C
0	70	Woods, Good, HSG C
0	65	Brush, Good, HSG C
12,705	84	Weighted Average
6,721		52.90% Pervious Area
5,984		47.10% Impervious Area

Tc (min)	Length (feet)	Slope (ft/ft)	Velocity (ft/sec)	Capacity (cfs)	Description
7.2	68	0.0200	0.16		Sheet Flow, Sheet Flow Grass: Short n= 0.150 P2= 3.23"
0.1	98	0.0300	31.02	620.33	Channel Flow, Channel Flow Area= 20.0 sf Perim= 10.2' r= 1.96' n= 0.013 Asphalt, smooth
7.3	166	Total			

Summary for Subcatchment PS18: PS-18

[49] Hint: Tc<2dt may require smaller dt

Runoff = 0.8 cfs @ 12.07 hrs, Volume= 2,350 cf, Depth> 3.56"

Runoff by SCS TR-20 method, UH=SCS, Weighted-CN, Time Span= 0.00-24.00 hrs, dt= 0.06 hrs
 Type III 24-hr 10-YR Rainfall=5.65"

Area (sf)	CN	Description
611	98	Paved parking, HSG B
0	98	Roofs, HSG B
182	61	>75% Grass cover, Good, HSG B
0	55	Woods, Good, HSG B
1,535	58	Woods/grass comb., Good, HSG B
2,125	98	Paved parking, HSG C
688	98	Roofs, HSG C
2,348	74	>75% Grass cover, Good, HSG C
0	70	Woods, Good, HSG C
424	72	Woods/grass comb., Good, HSG C
7,913	81	Weighted Average
4,489		56.73% Pervious Area
3,424		43.27% Impervious Area

Tc (min)	Length (feet)	Slope (ft/ft)	Velocity (ft/sec)	Capacity (cfs)	Description
1.1	22	0.2500	0.35		Sheet Flow, Sheet Flow Grass: Short n= 0.150 P2= 3.23"
0.1	102	0.0300	31.02	620.33	Channel Flow, Channel Flow Area= 20.0 sf Perim= 10.2' r= 1.96' n= 0.013 Asphalt, smooth
3.8					Direct Entry, Min Tc of 5 Min
5.0	124	Total			

Summary for Subcatchment PS19: PS-19

[49] Hint: Tc<2dt may require smaller dt

Runoff = 0.7 cfs @ 12.07 hrs, Volume= 2,263 cf, Depth> 3.56"

Runoff by SCS TR-20 method, UH=SCS, Weighted-CN, Time Span= 0.00-24.00 hrs, dt= 0.06 hrs
 Type III 24-hr 10-YR Rainfall=5.65"

Area (sf)	CN	Description
865	98	Paved parking, HSG B
313	98	Roofs, HSG B
1,705	61	>75% Grass cover, Good, HSG B
0	55	Woods, Good, HSG B
302	58	Woods/grass comb., Good, HSG B
1,631	98	Paved parking, HSG C
534	98	Roofs, HSG C
1,922	74	>75% Grass cover, Good, HSG C
0	70	Woods, Good, HSG C
348	72	Woods/grass comb., Good, HSG C
7,620	81	Weighted Average
4,277		56.13% Pervious Area
3,343		43.87% Impervious Area

477361-00_PRE-&-POST_2020-04-20

Prepared by {enter your company name here}
 HydroCAD® 10.10-3a s/n 00866 © 2020 HydroCAD Software Solutions LLC

Tc (min)	Length (feet)	Slope (ft/ft)	Velocity (ft/sec)	Capacity (cfs)	Description
3.3	44	0.0600	0.23		Sheet Flow, Sheet Flow Grass: Short n= 0.150 P2= 3.23"
0.1	120	0.0300	31.02	620.33	Channel Flow, Channel Flow Area= 20.0 sf Perim= 10.2' r= 1.96' n= 0.013 Asphalt, smooth
1.6					Direct Entry, Min Tc of 5 Min
5.0	164	Total			

Summary for Subcatchment PS20: PS-20

[49] Hint: Tc<2dt may require smaller dt

Runoff = 0.4 cfs @ 12.07 hrs, Volume= 1,382 cf, Depth> 4.39"

Runoff by SCS TR-20 method, UH=SCS, Weighted-CN, Time Span= 0.00-24.00 hrs, dt= 0.06 hrs
 Type III 24-hr 10-YR Rainfall=5.65"

Area (sf)	CN	Description
14	98	Paved parking, HSG B
0	48	Brush, Good, HSG B
2,480	98	Paved parking, HSG C
0	98	Roofs, HSG C
584	74	>75% Grass cover, Good, HSG C
0	70	Woods, Good, HSG C
695	72	Woods/grass comb., Good, HSG C
3,773	89	Weighted Average
1,279		33.90% Pervious Area
2,494		66.10% Impervious Area

Tc (min)	Length (feet)	Slope (ft/ft)	Velocity (ft/sec)	Capacity (cfs)	Description
0.9	22	0.3300	0.39		Sheet Flow, Sheet Flow Grass: Short n= 0.150 P2= 3.23"
0.0	106	0.0600	43.86	877.27	Channel Flow, Channel Flow Area= 20.0 sf Perim= 10.2' r= 1.96' n= 0.013 Asphalt, smooth
4.1					Direct Entry, Min Tc of 5 Min
5.0	128	Total			

Summary for Subcatchment PS21: PS-21

[49] Hint: Tc<2dt may require smaller dt

Runoff = 0.4 cfs @ 12.07 hrs, Volume= 1,355 cf, Depth> 4.50"

Runoff by SCS TR-20 method, UH=SCS, Weighted-CN, Time Span= 0.00-24.00 hrs, dt= 0.06 hrs
 Type III 24-hr 10-YR Rainfall=5.65"

Area (sf)	CN	Description
10	98	Paved parking, HSG B
2,486	98	Paved parking, HSG C
0	98	Roofs, HSG C
580	74	>75% Grass cover, Good, HSG C
0	70	Woods, Good, HSG C
536	72	Woods/grass comb., Good, HSG C
3,612	90	Weighted Average
1,116		30.90% Pervious Area
2,496		69.10% Impervious Area

Tc (min)	Length (feet)	Slope (ft/ft)	Velocity (ft/sec)	Capacity (cfs)	Description
0.9	22	0.3300	0.39		Sheet Flow, Sheet Flow Grass: Short n= 0.150 P2= 3.23"
0.0	102	0.0600	43.86	877.27	Channel Flow, Channel Flow Area= 20.0 sf Perim= 10.2' r= 1.96' n= 0.013 Asphalt, smooth
4.1					Direct Entry, Min Tc of 5 Min
5.0	124	Total			

Summary for Subcatchment PS22: PS-22

Runoff = 0.5 cfs @ 12.16 hrs, Volume= 1,987 cf, Depth> 2.98"

Runoff by SCS TR-20 method, UH=SCS, Weighted-CN, Time Span= 0.00-24.00 hrs, dt= 0.06 hrs
 Type III 24-hr 10-YR Rainfall=5.65"

477361-00_PRE-&POST_2020-04-20

Prepared by {enter your company name here}
 HydroCAD® 10.10-3a s/n 00866 © 2020 HydroCAD Software Solutions LLC

Area (sf)	CN	Description
2,338	98	Paved parking, HSG B
0	98	Roofs, HSG B
4,808	61	>75% Grass cover, Good, HSG B
0	55	Woods, Good, HSG B
0	48	Brush, Good, HSG B
636	98	Paved parking, HSG C
0	98	Roofs, HSG C
219	74	>75% Grass cover, Good, HSG C
0	70	Woods, Good, HSG C
0	65	Brush, Good, HSG C
8,001	75	Weighted Average
5,027		62.83% Pervious Area
2,974		37.17% Impervious Area

Tc (min)	Length (feet)	Slope (ft/ft)	Velocity (ft/sec)	Capacity (cfs)	Description
9.8	100	0.0200	0.17		Sheet Flow, Sheet Flow Grass: Short n= 0.150 P2= 3.23"
1.0	175	0.0400	3.00		Shallow Concentrated Flow, Shallow Concentrated Grassed Waterway Kv= 15.0 fps
10.8	275	Total			

Summary for Reach PR01: PR-01

Inflow Area = 501,780 sf, 0.00% Impervious, Inflow Depth > 1.35" for 10-YR event
 Inflow = 4.8 cfs @ 13.43 hrs, Volume= 56,442 cf
 Outflow = 4.5 cfs @ 13.70 hrs, Volume= 55,208 cf, Atten= 6%, Lag= 15.9 min

Routing by Dyn-Stor-Ind method, Time Span= 0.00-24.00 hrs, dt= 0.06 hrs / 2
 Max. Velocity= 0.42 fps, Min. Travel Time= 21.1 min
 Avg. Velocity = 0.24 fps, Avg. Travel Time= 36.7 min

Peak Storage= 5,651 cf @ 13.70 hrs
 Average Depth at Peak Storage= 0.08', Surface Width= 142.58'
 Bank-Full Depth= 2.00' Flow Area= 470.0 sf, Capacity= 1,413.2 cfs

135.00' x 2.00' deep channel, n= 0.050 Scattered brush, heavy weeds
 Side Slope Z-value= 50.0 ' / ' Top Width= 335.00'
 Length= 537.0' Slope= 0.0065 ' / '
 Inlet Invert= 26.50', Outlet Invert= 23.00'



Summary for Reach PR02: PR02

Inflow Area = 760,995 sf, 10.02% Impervious, Inflow Depth > 2.40" for 10-YR event
 Inflow = 17.4 cfs @ 12.84 hrs, Volume= 151,988 cf
 Outflow = 16.0 cfs @ 13.02 hrs, Volume= 149,522 cf, Atten= 8%, Lag= 10.8 min

Routing by Dyn-Stor-Ind method, Time Span= 0.00-24.00 hrs, dt= 0.06 hrs / 2
 Max. Velocity= 0.71 fps, Min. Travel Time= 15.7 min
 Avg. Velocity = 0.28 fps, Avg. Travel Time= 39.2 min

Peak Storage= 15,038 cf @ 13.02 hrs
 Average Depth at Peak Storage= 0.20', Surface Width= 123.77'
 Bank-Full Depth= 2.00' Flow Area= 408.0 sf, Capacity= 1,097.9 cfs

104.00' x 2.00' deep channel, n= 0.050 Scattered brush, heavy weeds
 Side Slope Z-value= 50.0 ' / ' Top Width= 304.00'
 Length= 668.0' Slope= 0.0055 ' / '
 Inlet Invert= 25.70', Outlet Invert= 22.00'



Summary for Reach PR03: PR03

Inflow Area = 255,973 sf, 14.18% Impervious, Inflow Depth > 2.47" for 10-YR event
 Inflow = 7.5 cfs @ 12.64 hrs, Volume= 52,737 cf
 Outflow = 5.3 cfs @ 13.01 hrs, Volume= 51,299 cf, Atten= 29%, Lag= 22.1 min

Routing by Dyn-Stor-Ind method, Time Span= 0.00-24.00 hrs, dt= 0.06 hrs / 2
 Max. Velocity= 0.52 fps, Min. Travel Time= 28.7 min
 Avg. Velocity = 0.27 fps, Avg. Travel Time= 54.9 min

477361-00_PRE-&POST_2020-04-20

Prepared by {enter your company name here}
 HydroCAD® 10.10-3a s/n 00866 © 2020 HydroCAD Software Solutions LLC

Peak Storage= 9,130 cf @ 13.01 hrs
 Average Depth at Peak Storage= 0.09' , Surface Width= 111.12'
 Bank-Full Depth= 2.00' Flow Area= 358.0 sf, Capacity= 1,142.3 cfs

104.00' x 2.00' deep channel, n= 0.080 Earth, long dense weeds
 Side Slope Z-value= 50.0 25.0 ' / ' Top Width= 254.00'
 Length= 894.0' Slope= 0.0187 ' / '
 Inlet Invert= 43.50', Outlet Invert= 26.80'



Summary for Reach PR04: PR-04

[62] Hint: Exceeded Reach PR09 OUTLET depth by 10.95' @ 12.30 hrs

Inflow Area = 1,172,686 sf, 1.46% Impervious, Inflow Depth > 1.73" for 10-YR event
 Inflow = 14.5 cfs @ 13.28 hrs, Volume= 168,655 cf
 Outflow = 13.8 cfs @ 13.48 hrs, Volume= 165,623 cf, Atten= 5%, Lag= 11.8 min

Routing by Dyn-Stor-Ind method, Time Span= 0.00-24.00 hrs, dt= 0.06 hrs / 2
 Max. Velocity= 0.64 fps, Min. Travel Time= 17.6 min
 Avg. Velocity = 0.34 fps, Avg. Travel Time= 33.7 min

Peak Storage= 14,553 cf @ 13.48 hrs
 Average Depth at Peak Storage= 0.14' , Surface Width= 150.21'
 Bank-Full Depth= 3.00' Flow Area= 569.4 sf, Capacity= 2,431.4 cfs

146.00' x 3.00' deep channel, n= 0.080 Earth, long dense weeds
 Side Slope Z-value= 17.0 12.2 ' / ' Top Width= 233.60'
 Length= 682.0' Slope= 0.0161 ' / '
 Inlet Invert= 33.00', Outlet Invert= 22.00'



Summary for Reach PR05a: PR-05a

Inflow = 0.0 cfs @ 0.00 hrs, Volume= 0 cf
 Outflow = 0.0 cfs @ 0.00 hrs, Volume= 0 cf, Atten= 0%, Lag= 0.0 min

Routing by Dyn-Stor-Ind method, Time Span= 0.00-24.00 hrs, dt= 0.06 hrs / 2
 Max. Velocity= 0.00 fps, Min. Travel Time= 0.0 min
 Avg. Velocity = 0.00 fps, Avg. Travel Time= 0.0 min

Peak Storage= 0 cf @ 0.00 hrs
 Average Depth at Peak Storage= 0.00'
 Bank-Full Depth= 1.00' Flow Area= 80.0 sf, Capacity= 106.1 cfs

30.00' x 1.00' deep channel, n= 0.100 Earth, dense brush, high stage
 Side Slope Z-value= 50.0 ' / ' Top Width= 130.00'
 Length= 46.0' Slope= 0.0152 ' / '
 Inlet Invert= 27.50', Outlet Invert= 26.80'



Summary for Reach PR05b: PR-05b

Inflow Area = 37,196 sf, 48.36% Impervious, Inflow Depth > 1.76" for 10-YR event
 Inflow = 0.1 cfs @ 16.14 hrs, Volume= 5,451 cf
 Outflow = 0.1 cfs @ 16.19 hrs, Volume= 5,424 cf, Atten= 0%, Lag= 3.2 min

Routing by Dyn-Stor-Ind method, Time Span= 0.00-24.00 hrs, dt= 0.06 hrs / 2
 Max. Velocity= 0.19 fps, Min. Travel Time= 4.0 min
 Avg. Velocity = 0.17 fps, Avg. Travel Time= 4.6 min

Peak Storage= 28 cf @ 16.19 hrs
 Average Depth at Peak Storage= 0.02' , Surface Width= 31.97'
 Bank-Full Depth= 1.00' Flow Area= 80.0 sf, Capacity= 155.3 cfs

30.00' x 1.00' deep channel, n= 0.100 Earth, dense brush, high stage
 Side Slope Z-value= 50.0 ' / ' Top Width= 130.00'
 Length= 46.0' Slope= 0.0326 ' / '
 Inlet Invert= 27.50', Outlet Invert= 26.00'



Summary for Reach PR06a: PR-06a

Inflow Area = 42,430 sf, 47.09% Impervious, Inflow Depth > 3.72" for 10-YR event
 Inflow = 1.6 cfs @ 12.44 hrs, Volume= 13,152 cf
 Outflow = 1.3 cfs @ 12.61 hrs, Volume= 13,028 cf, Atten= 21%, Lag= 9.9 min

Routing by Dyn-Stor-Ind method, Time Span= 0.00-24.00 hrs, dt= 0.06 hrs / 2
 Max. Velocity= 0.25 fps, Min. Travel Time= 13.1 min
 Avg. Velocity = 0.13 fps, Avg. Travel Time= 25.7 min

Peak Storage= 1,017 cf @ 12.61 hrs
 Average Depth at Peak Storage= 0.14', Surface Width= 44.20'
 Bank-Full Depth= 1.00' Flow Area= 80.0 sf, Capacity= 58.7 cfs

30.00' x 1.00' deep channel, n= 0.100 Earth, dense brush, high stage
 Side Slope Z-value= 50.0 '/' Top Width= 130.00'
 Length= 193.0' Slope= 0.0047 '/'
 Inlet Invert= 44.90', Outlet Invert= 44.00'



Summary for Reach PR06b: PR-06b

Inflow Area = 20,953 sf, 46.74% Impervious, Inflow Depth > 1.98" for 10-YR event
 Inflow = 0.5 cfs @ 12.49 hrs, Volume= 3,463 cf
 Outflow = 0.2 cfs @ 13.71 hrs, Volume= 3,234 cf, Atten= 71%, Lag= 73.2 min

Routing by Dyn-Stor-Ind method, Time Span= 0.00-24.00 hrs, dt= 0.06 hrs / 2
 Max. Velocity= 0.18 fps, Min. Travel Time= 99.5 min
 Avg. Velocity = 0.15 fps, Avg. Travel Time= 121.4 min

Peak Storage= 914 cf @ 13.71 hrs
 Average Depth at Peak Storage= 0.03', Surface Width= 32.64'
 Bank-Full Depth= 2.00' Flow Area= 260.0 sf, Capacity= 565.3 cfs

30.00' x 2.00' deep channel, n= 0.100 Earth, dense brush, high stage
 Side Slope Z-value= 50.0 '/' Top Width= 230.00'
 Length= 1,100.0' Slope= 0.0182 '/'
 Inlet Invert= 43.00', Outlet Invert= 23.00'



Summary for Reach PR07: PR-07

Inflow Area = 5,845 sf, 18.63% Impervious, Inflow Depth > 1.51" for 10-YR event
 Inflow = 0.2 cfs @ 12.30 hrs, Volume= 736 cf
 Outflow = 0.1 cfs @ 12.80 hrs, Volume= 731 cf, Atten= 74%, Lag= 30.2 min

Routing by Dyn-Stor-Ind method, Time Span= 0.00-24.00 hrs, dt= 0.06 hrs / 2
 Max. Velocity= 0.19 fps, Min. Travel Time= 56.8 min
 Avg. Velocity = 0.19 fps, Avg. Travel Time= 56.8 min

Peak Storage= 202 cf @ 12.80 hrs
 Average Depth at Peak Storage= 0.01', Surface Width= 31.03'
 Bank-Full Depth= 2.00' Flow Area= 260.0 sf, Capacity= 726.3 cfs

30.00' x 2.00' deep channel, n= 0.100 Earth, dense brush, high stage
 Side Slope Z-value= 50.0 '/' Top Width= 230.00'
 Length= 633.0' Slope= 0.0300 '/'
 Inlet Invert= 42.00', Outlet Invert= 23.00'



477361-00_PRE-&POST_2020-04-20

Prepared by {enter your company name here}
 HydroCAD® 10.10-3a s/n 00866 © 2020 HydroCAD Software Solutions LLC

Summary for Reach PR08: PR-08

Inflow Area = 14,865 sf, 8.98% Impervious, Inflow Depth > 0.57" for 10-YR event
 Inflow = 0.1 cfs @ 14.67 hrs, Volume= 703 cf
 Outflow = 0.0 cfs @ 16.09 hrs, Volume= 682 cf, Atten= 36%, Lag= 85.1 min

Routing by Dyn-Stor-Ind method, Time Span= 0.00-24.00 hrs, dt= 0.06 hrs / 2
 Max. Velocity= 0.20 fps, Min. Travel Time= 67.3 min
 Avg. Velocity = 0.20 fps, Avg. Travel Time= 67.3 min

Peak Storage= 156 cf @ 16.09 hrs
 Average Depth at Peak Storage= 0.01' , Surface Width= 30.62'
 Bank-Full Depth= 2.00' Flow Area= 260.0 sf, Capacity= 788.5 cfs

30.00' x 2.00' deep channel, n= 0.100 Earth, dense brush, high stage
 Side Slope Z-value= 50.0 ' / ' Top Width= 230.00'
 Length= 814.0' Slope= 0.0354 ' / '
 Inlet Invert= 62.00', Outlet Invert= 33.20'



Summary for Reach PR09: PR-09

[62] Hint: Exceeded Reach PR08 OUTLET depth by 0.09' @ 13.32 hrs

Inflow Area = 1,016,726 sf, 1.14% Impervious, Inflow Depth > 1.63" for 10-YR event
 Inflow = 14.2 cfs @ 13.10 hrs, Volume= 138,064 cf
 Outflow = 13.5 cfs @ 13.29 hrs, Volume= 135,856 cf, Atten= 5%, Lag= 11.8 min

Routing by Dyn-Stor-Ind method, Time Span= 0.00-24.00 hrs, dt= 0.06 hrs / 2
 Max. Velocity= 0.74 fps, Min. Travel Time= 15.4 min
 Avg. Velocity = 0.37 fps, Avg. Travel Time= 30.5 min

Peak Storage= 12,421 cf @ 13.29 hrs
 Average Depth at Peak Storage= 0.19' , Surface Width= 104.11'
 Bank-Full Depth= 2.00' Flow Area= 346.0 sf, Capacity= 992.5 cfs

88.00' x 2.00' deep channel, n= 0.080 Earth, long dense weeds
 Side Slope Z-value= 25.0 60.0 ' / ' Top Width= 258.00'
 Length= 682.0' Slope= 0.0161 ' / '
 Inlet Invert= 33.10', Outlet Invert= 22.10'



Summary for Pond CB01: CB-01

[87] Warning: Oscillations may require smaller dt or Finer Routing (severity=52)

Inflow Area = 7,913 sf, 43.27% Impervious, Inflow Depth > 3.56" for 10-YR event
 Inflow = 0.8 cfs @ 12.07 hrs, Volume= 2,350 cf
 Outflow = 0.8 cfs @ 12.07 hrs, Volume= 2,350 cf, Atten= 0%, Lag= 0.0 min
 Primary = 0.8 cfs @ 12.07 hrs, Volume= 2,350 cf

Routing by Dyn-Stor-Ind method, Time Span= 0.00-24.00 hrs, dt= 0.06 hrs / 2
 Peak Elev= 33.70' @ 17.35 hrs
 Flood Elev= 35.40'

Device	Routing	Invert	Outlet Devices
#1	Primary	32.20'	12.0" Round Culvert L= 18.0' CPP, square edge headwall, Ke= 0.500 Inlet / Outlet Invert= 32.20' / 32.10' S= 0.0056 ' / ' Cc= 0.900 n= 0.013 Corrugated PE, smooth interior, Flow Area= 0.79 sf

Primary OutFlow Max=0.7 cfs @ 12.07 hrs HW=32.72' TW=32.31' (Dynamic Tailwater)
 1=Culvert (Barrel Controls 0.7 cfs @ 2.59 fps)

Summary for Pond CB02: CB-02

[87] Warning: Oscillations may require smaller dt or Finer Routing (severity=54)

Inflow Area = 7,620 sf, 43.87% Impervious, Inflow Depth > 3.56" for 10-YR event
 Inflow = 0.7 cfs @ 12.07 hrs, Volume= 2,263 cf
 Outflow = 0.7 cfs @ 12.07 hrs, Volume= 2,263 cf, Atten= 0%, Lag= 0.0 min
 Primary = 0.7 cfs @ 12.07 hrs, Volume= 2,263 cf

Routing by Dyn-Stor-Ind method, Time Span= 0.00-24.00 hrs, dt= 0.06 hrs / 2

477361-00_PRE-&-POST_2020-04-20

Prepared by {enter your company name here}
 HydroCAD® 10.10-3a s/n 00866 © 2020 HydroCAD Software Solutions LLC

Peak Elev= 33.70' @ 17.39 hrs
 Flood Elev= 35.40'

Device	Routing	Invert	Outlet Devices
#1	Primary	32.20'	12.0" Round Culvert L= 18.0' CPP, square edge headwall, Ke= 0.500 Inlet / Outlet Invert= 32.20' / 32.10' S= 0.0056 ' Cc= 0.900 n= 0.013 Corrugated PE, smooth interior, Flow Area= 0.79 sf

Primary OutFlow Max=0.7 cfs @ 12.07 hrs HW=32.71' TW=32.31' (Dynamic Tailwater)
 ↑**1=Culvert** (Barrel Controls 0.7 cfs @ 2.57 fps)

Summary for Pond CB03: CB-03

Inflow Area = 8,958 sf, 58.47% Impervious, Inflow Depth > 4.29" for 10-YR event
 Inflow = 1.0 cfs @ 12.08 hrs, Volume= 3,200 cf
 Outflow = 1.0 cfs @ 12.08 hrs, Volume= 3,200 cf, Atten= 0%, Lag= 0.0 min
 Primary = 1.0 cfs @ 12.08 hrs, Volume= 3,200 cf

Routing by Dyn-Stor-Ind method, Time Span= 0.00-24.00 hrs, dt= 0.06 hrs / 2
 Peak Elev= 41.51' @ 12.08 hrs
 Flood Elev= 45.95'

Device	Routing	Invert	Outlet Devices
#1	Primary	41.00'	12.0" Round Culvert L= 42.0' CPP, square edge headwall, Ke= 0.500 Inlet / Outlet Invert= 41.00' / 39.20' S= 0.0429 ' Cc= 0.900 n= 0.013 Corrugated PE, smooth interior, Flow Area= 0.79 sf

Primary OutFlow Max=0.9 cfs @ 12.08 hrs HW=41.50' TW=34.11' (Dynamic Tailwater)
 ↑**1=Culvert** (Inlet Controls 0.9 cfs @ 2.40 fps)

Summary for Pond CB04: CB-04

Inflow Area = 12,705 sf, 47.10% Impervious, Inflow Depth > 3.87" for 10-YR event
 Inflow = 1.2 cfs @ 12.11 hrs, Volume= 4,093 cf
 Outflow = 1.2 cfs @ 12.11 hrs, Volume= 4,093 cf, Atten= 0%, Lag= 0.0 min
 Primary = 1.2 cfs @ 12.11 hrs, Volume= 4,093 cf

Routing by Dyn-Stor-Ind method, Time Span= 0.00-24.00 hrs, dt= 0.06 hrs / 2
 Peak Elev= 41.58' @ 12.11 hrs
 Flood Elev= 44.90'

Device	Routing	Invert	Outlet Devices
#1	Primary	41.00'	12.0" Round Culvert L= 37.0' CPP, square edge headwall, Ke= 0.500 Inlet / Outlet Invert= 41.00' / 39.20' S= 0.0486 ' Cc= 0.900 n= 0.013 Corrugated PE, smooth interior, Flow Area= 0.79 sf

Primary OutFlow Max=1.2 cfs @ 12.11 hrs HW=41.57' TW=34.29' (Dynamic Tailwater)
 ↑**1=Culvert** (Inlet Controls 1.2 cfs @ 2.57 fps)

Summary for Pond CB05: CB-05

Inflow Area = 5,051 sf, 20.97% Impervious, Inflow Depth > 3.27" for 10-YR event
 Inflow = 0.4 cfs @ 12.08 hrs, Volume= 1,376 cf
 Outflow = 0.4 cfs @ 12.08 hrs, Volume= 1,376 cf, Atten= 0%, Lag= 0.0 min
 Primary = 0.4 cfs @ 12.08 hrs, Volume= 1,376 cf

Routing by Dyn-Stor-Ind method, Time Span= 0.00-24.00 hrs, dt= 0.06 hrs / 2
 Peak Elev= 48.01' @ 12.43 hrs
 Flood Elev= 48.58'

Device	Routing	Invert	Outlet Devices
#1	Primary	46.30'	6.0" Round Culvert L= 15.0' CPP, square edge headwall, Ke= 0.500 Inlet / Outlet Invert= 46.30' / 46.15' S= 0.0100 ' Cc= 0.900 n= 0.013 Corrugated PE, smooth interior, Flow Area= 0.20 sf

Primary OutFlow Max=0.4 cfs @ 12.08 hrs HW=47.30' TW=47.09' (Dynamic Tailwater)
 ↑**1=Culvert** (Inlet Controls 0.4 cfs @ 2.18 fps)

Summary for Pond CB06: CB-06

Inflow Area = 4,235 sf, 19.50% Impervious, Inflow Depth > 3.27" for 10-YR event
 Inflow = 0.4 cfs @ 12.08 hrs, Volume= 1,154 cf
 Outflow = 0.4 cfs @ 12.08 hrs, Volume= 1,154 cf, Atten= 0%, Lag= 0.0 min
 Primary = 0.4 cfs @ 12.08 hrs, Volume= 1,154 cf

Routing by Dyn-Stor-Ind method, Time Span= 0.00-24.00 hrs, dt= 0.06 hrs / 2
 Peak Elev= 45.60' @ 12.08 hrs
 Flood Elev= 48.58'

Device	Routing	Invert	Outlet Devices
#1	Primary	45.15'	6.0" Round Culvert L= 15.0' CPP, square edge headwall, Ke= 0.500 Inlet / Outlet Invert= 45.15' / 45.00' S= 0.0100 ' Cc= 0.900 n= 0.013 Corrugated PE, smooth interior, Flow Area= 0.20 sf

Primary OutFlow Max=0.4 cfs @ 12.08 hrs HW=45.59' TW=44.80' (Dynamic Tailwater)
 ↑**1=Culvert** (Barrel Controls 0.4 cfs @ 2.60 fps)

477361-00_PRE-&POST_2020-04-20

Prepared by {enter your company name here}
 HydroCAD® 10.10-3a s/n 00866 © 2020 HydroCAD Software Solutions LLC

Summary for Pond CB07: CB-07

Inflow Area = 37,379 sf, 50.62% Impervious, Inflow Depth > 3.86" for 10-YR event
 Inflow = 3.0 cfs @ 12.17 hrs, Volume= 12,028 cf
 Outflow = 3.0 cfs @ 12.17 hrs, Volume= 12,028 cf, Atten= 0%, Lag= 0.0 min
 Primary = 3.0 cfs @ 12.17 hrs, Volume= 12,028 cf

Routing by Dyn-Stor-Ind method, Time Span= 0.00-24.00 hrs, dt= 0.06 hrs / 2
 Peak Elev= 50.61' @ 12.17 hrs
 Flood Elev= 52.50'

Device	Routing	Invert	Outlet Devices
#1	Primary	49.50'	12.0" Round Culvert L= 114.0' CPP, square edge headwall, Ke= 0.500 Inlet / Outlet Invert= 49.50' / 47.50' S= 0.0175 '/' Cc= 0.900 n= 0.013 Corrugated PE, smooth interior, Flow Area= 0.79 sf

Primary OutFlow Max=2.9 cfs @ 12.17 hrs HW=50.60' TW=47.50' (Dynamic Tailwater)
 ↑**1=Culvert** (Inlet Controls 2.9 cfs @ 3.73 fps)

Summary for Pond CB08: CB-08

Inflow Area = 16,718 sf, 53.64% Impervious, Inflow Depth > 3.89" for 10-YR event
 Inflow = 1.6 cfs @ 12.10 hrs, Volume= 5,414 cf
 Outflow = 1.6 cfs @ 12.10 hrs, Volume= 5,414 cf, Atten= 0%, Lag= 0.0 min
 Primary = 1.6 cfs @ 12.10 hrs, Volume= 5,414 cf

Routing by Dyn-Stor-Ind method, Time Span= 0.00-24.00 hrs, dt= 0.06 hrs / 2
 Peak Elev= 50.18' @ 12.10 hrs
 Flood Elev= 52.50'

Device	Routing	Invert	Outlet Devices
#1	Primary	49.50'	12.0" Round Culvert L= 110.0' CPP, square edge headwall, Ke= 0.500 Inlet / Outlet Invert= 49.50' / 46.00' S= 0.0318 '/' Cc= 0.900 n= 0.013 Corrugated PE, smooth interior, Flow Area= 0.79 sf

Primary OutFlow Max=1.5 cfs @ 12.10 hrs HW=50.17' TW=44.88' (Dynamic Tailwater)
 ↑**1=Culvert** (Inlet Controls 1.5 cfs @ 2.78 fps)

Summary for Pond Ci01: CURB INLET 1

Inflow Area = 3,773 sf, 66.10% Impervious, Inflow Depth > 4.39" for 10-YR event
 Inflow = 0.4 cfs @ 12.07 hrs, Volume= 1,382 cf
 Outflow = 0.4 cfs @ 12.07 hrs, Volume= 1,382 cf, Atten= 0%, Lag= 0.0 min
 Primary = 0.4 cfs @ 12.07 hrs, Volume= 1,382 cf

Routing by Dyn-Stor-Ind method, Time Span= 0.00-24.00 hrs, dt= 0.06 hrs / 2
 Peak Elev= 26.80' @ 12.07 hrs
 Flood Elev= 27.70'

Device	Routing	Invert	Outlet Devices
#1	Primary	26.70'	48.0" W x 4.0" H Vert. Orifice/Grate C= 0.600 Limited to weir flow at low heads

Primary OutFlow Max=0.4 cfs @ 12.07 hrs HW=26.80' TW=0.00' (Dynamic Tailwater)
 ↑**1=Orifice/Grate** (Orifice Controls 0.4 cfs @ 1.02 fps)

Summary for Pond Ci02: CURB INLET 2

Inflow Area = 3,612 sf, 69.10% Impervious, Inflow Depth > 4.50" for 10-YR event
 Inflow = 0.4 cfs @ 12.07 hrs, Volume= 1,355 cf
 Outflow = 0.4 cfs @ 12.07 hrs, Volume= 1,355 cf, Atten= 0%, Lag= 0.0 min
 Primary = 0.4 cfs @ 12.07 hrs, Volume= 1,355 cf

Routing by Dyn-Stor-Ind method, Time Span= 0.00-24.00 hrs, dt= 0.06 hrs / 2
 Peak Elev= 26.80' @ 12.07 hrs
 Flood Elev= 27.70'

Device	Routing	Invert	Outlet Devices
#1	Primary	26.70'	48.0" W x 4.0" H Vert. Orifice/Grate C= 0.600 Limited to weir flow at low heads

Primary OutFlow Max=0.4 cfs @ 12.07 hrs HW=26.80' TW=25.74' (Dynamic Tailwater)
 ↑**1=Orifice/Grate** (Orifice Controls 0.4 cfs @ 1.02 fps)

Summary for Pond MH01: MH 1

Inflow Area = 37,196 sf, 48.36% Impervious, Inflow Depth > 1.76" for 10-YR event
 Inflow = 0.1 cfs @ 16.14 hrs, Volume= 5,451 cf
 Outflow = 0.1 cfs @ 16.14 hrs, Volume= 5,451 cf, Atten= 0%, Lag= 0.0 min
 Primary = 0.1 cfs @ 16.14 hrs, Volume= 5,451 cf

Routing by Dyn-Stor-Ind method, Time Span= 0.00-24.00 hrs, dt= 0.06 hrs / 2
 Peak Elev= 28.67' @ 16.14 hrs
 Flood Elev= 39.00'

Device	Routing	Invert	Outlet Devices
#1	Primary	28.50'	12.0" Round Culvert L= 91.0' CPP, square edge headwall, Ke= 0.500

477361-00_PRE-&-POST_2020-04-20

Prepared by {enter your company name here}
 HydroCAD® 10.10-3a s/n 00866 © 2020 HydroCAD Software Solutions LLC

Inlet / Outlet Invert= 28.50' / 27.75' S= 0.0082 ' /' Cc= 0.900
 n= 0.012 Corrugated PP, smooth interior, Flow Area= 0.79 sf

Primary OutFlow Max=0.1 cfs @ 16.14 hrs HW=28.67' TW=27.52' (Dynamic Tailwater)
 ↳1=Culvert (Barrel Controls 0.1 cfs @ 2.01 fps)

Summary for Pond MH05: MH 5

Inflow Area = 8,001 sf, 37.17% Impervious, Inflow Depth = 0.00" for 10-YR event
 Inflow = 0.0 cfs @ 0.00 hrs, Volume= 0 cf
 Outflow = 0.0 cfs @ 0.00 hrs, Volume= 0 cf, Atten= 0%, Lag= 0.0 min
 Primary = 0.0 cfs @ 0.00 hrs, Volume= 0 cf

Routing by Dyn-Stor-Ind method, Time Span= 0.00-24.00 hrs, dt= 0.06 hrs / 2
 Peak Elev= 51.30' @ 0.00 hrs
 Flood Elev= 57.30'

Device	Routing	Invert	Outlet Devices
#1	Primary	51.30'	12.0" Round Culvert L= 65.0' CPP, square edge headwall, Ke= 0.500 Inlet / Outlet Invert= 51.30' / 47.90' S= 0.0523 ' /' Cc= 0.900 n= 0.013 Corrugated PE, smooth interior, Flow Area= 0.79 sf

Primary OutFlow Max=0.0 cfs @ 0.00 hrs HW=51.30' TW=33.10' (Dynamic Tailwater)
 ↳1=Culvert (Controls 0.0 cfs)

Summary for Pond PP01: CULVERTS

[62] Hint: Exceeded Reach PR01 OUTLET depth by 2.65' @ 14.34 hrs
 [62] Hint: Exceeded Reach PR02 OUTLET depth by 3.61' @ 14.34 hrs
 [62] Hint: Exceeded Reach PR04 OUTLET depth by 3.61' @ 14.40 hrs
 [62] Hint: Exceeded Reach PR06b OUTLET depth by 2.69' @ 14.28 hrs
 [62] Hint: Exceeded Reach PR07 OUTLET depth by 2.71' @ 14.28 hrs

Inflow Area = 2,940,052 sf, 4.04% Impervious, Inflow Depth > 1.87" for 10-YR event
 Inflow = 36.1 cfs @ 13.17 hrs, Volume= 457,094 cf
 Outflow = 21.6 cfs @ 14.25 hrs, Volume= 456,403 cf, Atten= 40%, Lag= 64.6 min
 Primary = 21.6 cfs @ 14.25 hrs, Volume= 456,403 cf
 Secondary = 0.0 cfs @ 0.00 hrs, Volume= 0 cf

Routing by Dyn-Stor-Ind method, Time Span= 0.00-24.00 hrs, dt= 0.06 hrs / 2
 Peak Elev= 25.72' @ 14.25 hrs Surf.Area= 135,906 sf Storage= 77,770 cf

Plug-Flow detention time= 30.4 min calculated for 456,403 cf (100% of inflow)
 Center-of-Mass det. time= 29.6 min (953.7 - 924.1)

Volume	Invert	Avail.Storage	Storage Description		
#1	22.00'	347,907 cf	Custom Stage Data (Irregular) Listed below (Recalc)		
Elevation (feet)	Surf.Area (sq-ft)	Perim. (feet)	Inc.Store (cubic-feet)	Cum.Store (cubic-feet)	Wet.Area (sq-ft)
22.00	10	40.0	0	0	10
24.00	5,297	274.3	3,691	3,691	5,879
25.00	33,326	789.9	17,303	20,995	49,546
26.00	194,474	2,151.9	102,768	123,763	368,395
27.00	255,187	2,316.1	224,144	347,907	426,819

Device	Routing	Invert	Outlet Devices
#1	Primary	22.40'	15.0" Round RCP_Round 15" L= 33.5' RCP, groove end projecting, Ke= 0.200 Inlet / Outlet Invert= 22.40' / 22.35' S= 0.0015 ' /' Cc= 0.900 n= 0.011 Concrete pipe, straight & clean, Flow Area= 1.23 sf
#2	Primary	22.40'	15.0" Round RCP_Round 15" L= 33.5' RCP, groove end projecting, Ke= 0.200 Inlet / Outlet Invert= 22.40' / 22.35' S= 0.0015 ' /' Cc= 0.900 n= 0.011 Concrete pipe, straight & clean, Flow Area= 1.23 sf
#3	Secondary	25.93'	50.0' long x 20.0' breadth Broad-Crested Rectangular Weir Head (feet) 0.20 0.40 0.60 0.80 1.00 1.20 1.40 1.60 Coef. (English) 2.68 2.70 2.70 2.64 2.63 2.64 2.64 2.63

Primary OutFlow Max=21.6 cfs @ 14.25 hrs HW=25.72' TW=0.00' (Dynamic Tailwater)
 ↳1=RCP_Round 15" (Barrel Controls 10.8 cfs @ 8.81 fps)
 ↳2=RCP_Round 15" (Barrel Controls 10.8 cfs @ 8.81 fps)

Secondary OutFlow Max=0.0 cfs @ 0.00 hrs HW=22.00' TW=0.00' (Dynamic Tailwater)
 ↳3=Broad-Crested Rectangular Weir (Controls 0.0 cfs)

Summary for Pond PP02: PP02

Inflow Area = 255,973 sf, 14.18% Impervious, Inflow Depth > 2.84" for 10-YR event
 Inflow = 8.4 cfs @ 12.49 hrs, Volume= 60,668 cf
 Outflow = 7.5 cfs @ 12.64 hrs, Volume= 52,737 cf, Atten= 10%, Lag= 8.9 min
 Primary = 7.5 cfs @ 12.64 hrs, Volume= 52,737 cf

Routing by Dyn-Stor-Ind method, Time Span= 0.00-24.00 hrs, dt= 0.06 hrs / 2
 Peak Elev= 43.78' @ 12.66 hrs Surf.Area= 22,564 sf Storage= 12,483 cf

Plug-Flow detention time= 92.4 min calculated for 52,737 cf (87% of inflow)
 Center-of-Mass det. time= 36.7 min (904.4 - 867.7)

477361-00_PRE-&-POST_2020-04-20

Prepared by {enter your company name here}
 HydroCAD® 10.10-3a s/n 00866 © 2020 HydroCAD Software Solutions LLC

Volume	Invert	Avail.Storage	Storage Description
#1	43.00'	17,987 cf	Custom Stage Data (Irregular) Listed below (Recalc)
Elevation (feet)	Surf.Area (sq-ft)	Perim. (feet)	Inc.Store (cubic-feet) Cum.Store (cubic-feet) Wet.Area (sq-ft)
43.00	10,339	760.4	0 0 10,339
44.00	26,935	899.1	17,987 17,987 28,674

Device	Routing	Invert	Outlet Devices
#1	Primary	43.53'	25.0' long x 10.0' breadth Broad-Crested Rectangular Weir Head (feet) 0.20 0.40 0.60 0.80 1.00 1.20 1.40 1.60 Coef. (English) 2.49 2.56 2.70 2.69 2.68 2.69 2.67 2.64

Primary OutFlow Max=7.5 cfs @ 12.64 hrs HW=43.78' TW=43.57' (Dynamic Tailwater)
 1=Broad-Crested Rectangular Weir (Weir Controls 7.5 cfs @ 1.22 fps)

Summary for Pond PP03a: R-Tank #1 and 2

[80] Warning: Exceeded Pond CB01 by 0.03' @ 23.58 hrs (0.6 cfs 3,162 cf)
 [80] Warning: Exceeded Pond CB02 by 1.37' @ 20.10 hrs (3.0 cfs 18,345 cf)

Inflow Area = 15,533 sf, 43.57% Impervious, Inflow Depth > 3.85" for 10-YR event
 Inflow = 1.5 cfs @ 12.07 hrs, Volume= 4,987 cf
 Outflow = 0.1 cfs @ 17.35 hrs, Volume= 2,435 cf, Atten= 96%, Lag= 316.7 min
 Primary = 0.1 cfs @ 17.35 hrs, Volume= 2,435 cf
 Secondary = 0.0 cfs @ 0.00 hrs, Volume= 0 cf

Routing by Dyn-Stor-Ind method, Time Span= 0.00-24.00 hrs, dt= 0.06 hrs / 2
 Peak Elev= 33.70' @ 17.35 hrs Surf.Area= 3,713 sf Storage= 3,192 cf
 Flood Elev= 37.18' Surf.Area= 4,563 sf Storage= 5,446 cf

Plug-Flow detention time= 350.9 min calculated for 2,435 cf (49% of inflow)
 Center-of-Mass det. time= 229.1 min (1,052.7 - 823.6)

Volume	Invert	Avail.Storage	Storage Description
#1	29.45'	295 cf	14.50'W x 50.90'L x 1.00'H Stone-1 738 cf Overall x 40.0% Voids
#2	30.45'	221 cf	14.50'W x 50.90'L x 1.50'H Filter Soil-1 -Impervious 1,107 cf Overall x 20.0% Voids
#3	31.95'	269 cf	50.90'L x 3.48'H Stone-1 Slope 1:1 on Left Z=1.0 673 cf Overall x 40.0% Voids
#4	31.95'	269 cf	50.90'L x 3.48'H Stone-1 Slope 1:1 on Right Z=1.0 673 cf Overall x 40.0% Voids
#5B	31.95'	588 cf	14.50'W x 50.92'L x 3.48'H Field B 2,570 cf Overall - 1,099 cf Embedded = 1,471 cf x 40.0% Voids
#6B	32.20'	1,044 cf	ACF R-Tank SD 3 x 160 Inside #5 Inside= 15.7"W x 26.8"H => 2.78 sf x 2.35'L = 6.5 cf Outside= 15.7"W x 26.8"H => 2.93 sf x 2.35'L = 6.9 cf 160 Chambers in 8 Rows
#7	29.45'	295 cf	14.50'W x 50.90'L x 1.00'H Stone-2 738 cf Overall x 40.0% Voids
#8	30.45'	221 cf	14.50'W x 50.90'L x 1.50'H Filter Soil-2 -Impervious 1,107 cf Overall x 20.0% Voids
#9	31.95'	269 cf	50.90'L x 3.48'H Stone-2 Slope 1:1 on Left Z=1.0 673 cf Overall x 40.0% Voids
#10	31.95'	269 cf	50.90'L x 3.48'H Stone-2 Slope 1:1 on Right Z=1.0 673 cf Overall x 40.0% Voids
#11C	31.95'	588 cf	14.50'W x 50.92'L x 3.48'H Field C 2,570 cf Overall - 1,099 cf Embedded = 1,471 cf x 40.0% Voids
#12C	32.20'	1,044 cf	ACF R-Tank SD 3 x 160 Inside #11 Inside= 15.7"W x 26.8"H => 2.78 sf x 2.35'L = 6.5 cf Outside= 15.7"W x 26.8"H => 2.93 sf x 2.35'L = 6.9 cf 160 Chambers in 8 Rows
#13	29.45'	72 cf	4.00'D x 5.70'H Manhole -Impervious
		5,446 cf	Total Available Storage

Storage Group B created with Chamber Wizard
 Storage Group C created with Chamber Wizard

Device	Routing	Invert	Outlet Devices
#1	Primary	29.45'	12.0" Round UD-Culvert L= 20.0' CPP, square edge headwall, Ke= 0.500 Inlet / Outlet Invert= 29.45' / 28.60' S= 0.0425 ' /' Cc= 0.900 n= 0.012 Corrugated PP, smooth interior, Flow Area= 0.79 sf
#2	Device 1	29.45'	1.0" Vert. UD-Orifice C= 0.600 Limited to weir flow at low heads
#3	Device 2	29.45'	10.000 in/hr Exfiltration over Surface area
#4	Secondary	33.75'	18.0" Round Culvert L= 53.0' CPP, square edge headwall, Ke= 0.500 Inlet / Outlet Invert= 33.75' / 32.95' S= 0.0151 ' /' Cc= 0.900 n= 0.012 Corrugated PP, smooth interior, Flow Area= 1.77 sf
#5	Device 4	33.93'	12.0" Horiz. Top of Stand Pipe C= 0.600 Limited to weir flow at low heads

477361-00_PRE-&-POST_2020-04-20

Prepared by {enter your company name here}
 HydroCAD® 10.10-3a s/n 00866 © 2020 HydroCAD Software Solutions LLC

Primary OutFlow Max=0.1 cfs @ 17.35 hrs HW=33.70' TW=28.67' (Dynamic Tailwater)
 ↳ **1=UD-Culvert** (Passes 0.1 cfs of 7.3 cfs potential flow)
 ↳ ↳ **2=UD-Orifice** (Orifice Controls 0.1 cfs @ 9.88 fps)
 ↳ ↳ ↳ **3=Exfiltration** (Passes 0.1 cfs of 0.9 cfs potential flow)

Secondary OutFlow Max=0.0 cfs @ 0.00 hrs HW=29.45' TW=27.50' (Dynamic Tailwater)
 ↳ **4=Culvert** (Controls 0.0 cfs)
 ↳ ↳ **5=Top of Stand Pipe** (Controls 0.0 cfs)

Summary for Pond PP03b: R-Tank #3 and 4

Inflow Area = 21,663 sf, 51.80% Impervious, Inflow Depth > 4.04" for 10-YR event
 Inflow = 2.2 cfs @ 12.10 hrs, Volume= 7,294 cf
 Outflow = 0.1 cfs @ 15.45 hrs, Volume= 3,390 cf, Atten= 96%, Lag= 201.4 min
 Primary = 0.1 cfs @ 15.45 hrs, Volume= 3,016 cf
 Secondary = 0.0 cfs @ 15.45 hrs, Volume= 374 cf

Routing by Dyn-Stor-Ind method, Time Span= 0.00-24.00 hrs, dt= 0.06 hrs / 2
 Peak Elev= 36.11' @ 15.45 hrs Surf.Area= 3,726 sf Storage= 4,778 cf
 Flood Elev= 39.85' Surf.Area= 4,797 sf Storage= 8,046 cf

Plug-Flow detention time= 336.9 min calculated for 3,390 cf (46% of inflow)
 Center-of-Mass det. time= 221.0 min (1,021.4 - 800.4)

Volume	Invert	Avail.Storage	Storage Description
#1	30.20'	241 cf	14.50'W x 41.53'L x 1.00'H Stone-3 602 cf Overall x 40.0% Voids
#2	31.20'	181 cf	14.50'W x 41.53'L x 1.50'H Filter Soil-3 -Impervious 903 cf Overall x 20.0% Voids
#3	32.70'	626 cf	41.53'L x 5.65'H Stone-3 Slope 1:1 on Left Z=1.0 1,566 cf Overall x 40.0% Voids
#4	32.70'	626 cf	41.53'L x 5.65'H Stone-3 Slope 1:1 on Right Z=1.0 1,566 cf Overall x 40.0% Voids
#5B	32.70'	667 cf	14.50'W x 41.53'L x 5.65'H Field B 3,400 cf Overall - 1,732 cf Embedded = 1,668 cf x 40.0% Voids
#6B	32.95'	1,646 cf	ACF R-Tank SD 6 x 128 Inside #5 Inside= 15.7"W x 52.8"H => 5.48 sf x 2.35'L = 12.9 cf Outside= 15.7"W x 52.8"H => 5.77 sf x 2.35'L = 13.5 cf 128 Chambers in 8 Rows
#7	30.20'	241 cf	14.50'W x 41.53'L x 1.00'H Stone-4 602 cf Overall x 40.0% Voids
#8	31.20'	181 cf	14.50'W x 41.53'L x 1.50'H Filter Soil-4 -Impervious 903 cf Overall x 20.0% Voids
#9	32.70'	626 cf	41.53'L x 5.65'H Stone-4 Slope 1:1 on Left Z=1.0 1,566 cf Overall x 40.0% Voids
#10	32.70'	626 cf	41.53'L x 5.65'H Stone-4 Slope 1:1 on Right Z=1.0 1,566 cf Overall x 40.0% Voids
#11C	32.70'	667 cf	14.50'W x 41.53'L x 5.65'H Field C 3,400 cf Overall - 1,732 cf Embedded = 1,668 cf x 40.0% Voids
#12C	32.95'	1,646 cf	ACF R-Tank SD 6 x 128 Inside #11 Inside= 15.7"W x 52.8"H => 5.48 sf x 2.35'L = 12.9 cf Outside= 15.7"W x 52.8"H => 5.77 sf x 2.35'L = 13.5 cf 128 Chambers in 8 Rows
#13	30.20'	72 cf	4.00'D x 5.70'H MH -Impervious
		8,046 cf	Total Available Storage

Storage Group B created with Chamber Wizard
 Storage Group C created with Chamber Wizard

Device	Routing	Invert	Outlet Devices
#1	Primary	29.80'	18.0" Round UD-Culvert L= 57.0' CPP, square edge headwall, Ke= 0.500 Inlet / Outlet Invert= 29.80' / 28.60' S= 0.0211 '/' Cc= 0.900 n= 0.012 Corrugated PP, smooth interior, Flow Area= 1.77 sf
#2	Device 1	30.20'	1.0" Vert. UD-Orifice C= 0.600 Limited to weir flow at low heads
#3	Device 2	30.20'	10.000 in/hr UD-Exfiltration over Surface area
#4	Secondary	32.50'	18.0" Round Culvert L= 10.0' CPP, square edge headwall, Ke= 0.500 Inlet / Outlet Invert= 32.50' / 32.25' S= 0.0250 '/' Cc= 0.900 n= 0.012 Corrugated PP, smooth interior, Flow Area= 1.77 sf
#5	Device 4	35.85'	1.0" Vert. Orifice X 2.00 C= 0.600 Limited to weir flow at low heads
#6	Device 4	37.35'	6.0" Horiz. Top Of Stand Pipe X 2.00 C= 0.600 Limited to weir flow at low heads

Primary OutFlow Max=0.1 cfs @ 15.45 hrs HW=36.11' TW=28.67' (Dynamic Tailwater)
 ↳ **1=UD-Culvert** (Passes 0.1 cfs of 20.1 cfs potential flow)
 ↳ ↳ **2=UD-Orifice** (Orifice Controls 0.1 cfs @ 11.66 fps)
 ↳ ↳ ↳ **3=UD-Exfiltration** (Passes 0.1 cfs of 0.9 cfs potential flow)

Secondary OutFlow Max=0.0 cfs @ 15.45 hrs HW=36.11' TW=33.64' (Dynamic Tailwater)
 ↳ **4=Culvert** (Passes 0.0 cfs of 13.4 cfs potential flow)
 ↳ ↳ **5=Orifice** (Orifice Controls 0.0 cfs @ 2.23 fps)
 ↳ ↳ ↳ **6=Top Of Stand Pipe** (Controls 0.0 cfs)

477361-00_PRE-&POST_2020-04-20

Prepared by {enter your company name here}
 HydroCAD® 10.10-3a s/n 00866 © 2020 HydroCAD Software Solutions LLC

Summary for Pond PP04A: Bioretention Area #2

[87] Warning: Oscillations may require smaller dt or Finer Routing (severity=48)

Inflow Area = 42,430 sf, 47.09% Impervious, Inflow Depth > 3.79" for 10-YR event
 Inflow = 3.3 cfs @ 12.16 hrs, Volume= 13,404 cf
 Outflow = 1.6 cfs @ 12.44 hrs, Volume= 13,152 cf, Atten= 50%, Lag= 17.3 min
 Primary = 1.6 cfs @ 12.44 hrs, Volume= 13,152 cf
 Secondary = 0.0 cfs @ 0.00 hrs, Volume= 0 cf

Routing by Dyn-Stor-Ind method, Time Span= 0.00-24.00 hrs, dt= 0.06 hrs / 2
 Peak Elev= 48.00' @ 12.44 hrs Surf.Area= 3,135 sf Storage= 4,346 cf
 Flood Elev= 49.00' Surf.Area= 4,729 sf Storage= 7,157 cf

Plug-Flow detention time= 91.8 min calculated for 13,119 cf (98% of inflow)
 Center-of-Mass det. time= 80.7 min (891.6 - 810.9)

Volume	Invert	Avail.Storage	Storage Description
#1	45.25'	255 cf	Engineered Soil Above Invert (Irregular) Listed below (Recalc) -Impervious 849 cf Overall x 30.0% Voids
#2	46.00'	6,902 cf	Custom Stage Data (Irregular) Listed below (Recalc)
		7,157 cf	Total Available Storage

Elevation (feet)	Surf.Area (sq-ft)	Perim. (feet)	Inc.Store (cubic-feet)	Cum.Store (cubic-feet)	Wet.Area (sq-ft)
45.25	1,132	332.5	0	0	1,132
46.00	1,132	332.5	849	849	1,381

Elevation (feet)	Surf.Area (sq-ft)	Perim. (feet)	Inc.Store (cubic-feet)	Cum.Store (cubic-feet)	Wet.Area (sq-ft)
46.00	1,132	332.5	0	0	1,132
48.50	3,800	379.6	5,838	5,838	3,946
48.75	4,729	392.2	1,064	6,902	4,725

Device	Routing	Invert	Outlet Devices
#1	Primary	45.25'	12.0" Round Culvert L= 50.0' CMP, square edge headwall, Ke= 0.500 Inlet / Outlet Invert= 45.25' / 45.00' S= 0.0050 ' S= 0.0050 ' Cc= 0.900 n= 0.013 Corrugated PE, smooth interior, Flow Area= 0.79 sf
#2	Device 1	45.25'	3.0" Vert. Orifice C= 0.600 Limited to weir flow at low heads
#3	Device 2	46.00'	10.000 in/hr Exfiltration Filter Soil over Surface area
#4	Device 1	47.75'	12.0" Horiz. Beehive Grage C= 0.600 Limited to weir flow at low heads
#5	Secondary	48.00'	10.0' long x 4.0' breadth Broad-Crested Rectangular Weir Head (feet) 0.20 0.40 0.60 0.80 1.00 1.20 1.40 1.60 1.80 2.00 2.50 3.00 3.50 4.00 4.50 5.00 5.50 Coef. (English) 2.38 2.54 2.69 2.68 2.67 2.67 2.65 2.66 2.66 2.68 2.72 2.73 2.76 2.79 2.88 3.07 3.32

Primary OutFlow Max=1.6 cfs @ 12.44 hrs HW=47.99' TW=45.02' (Dynamic Tailwater)

- 1=Culvert (Passes 1.6 cfs of 5.1 cfs potential flow)
- 2=Orifice (Orifice Controls 0.4 cfs @ 7.79 fps)
- 3=Exfiltration Filter Soil (Passes 0.4 cfs of 0.7 cfs potential flow)
- 4=Beehive Grage (Weir Controls 1.2 cfs @ 1.61 fps)

Secondary OutFlow Max=0.0 cfs @ 0.00 hrs HW=45.25' TW=44.90' (Dynamic Tailwater)

- 5=Broad-Crested Rectangular Weir (Controls 0.0 cfs)

Summary for Pond PP04B: Bioretention Area #3

Inflow Area = 20,953 sf, 46.74% Impervious, Inflow Depth > 3.76" for 10-YR event
 Inflow = 1.9 cfs @ 12.09 hrs, Volume= 6,568 cf
 Outflow = 0.5 cfs @ 12.49 hrs, Volume= 3,463 cf, Atten= 73%, Lag= 23.5 min
 Primary = 0.5 cfs @ 12.49 hrs, Volume= 3,463 cf
 Secondary = 0.0 cfs @ 0.00 hrs, Volume= 0 cf

Routing by Dyn-Stor-Ind method, Time Span= 0.00-24.00 hrs, dt= 0.06 hrs / 2
 Peak Elev= 45.39' @ 12.49 hrs Surf.Area= 2,581 sf Storage= 3,420 cf
 Flood Elev= 46.50' Surf.Area= 3,665 sf Storage= 6,081 cf

Plug-Flow detention time= 222.5 min calculated for 3,463 cf (53% of inflow)
 Center-of-Mass det. time= 112.4 min (920.3 - 807.9)

Volume	Invert	Avail.Storage	Storage Description
#1	42.75'	214 cf	Engineered Soil Above Invert (Irregular) Listed below (Recalc) -Impervious 713 cf Overall x 30.0% Voids
#2	43.50'	5,867 cf	Custom Stage Data (Irregular) Listed below (Recalc)
		6,081 cf	Total Available Storage

Elevation (feet)	Surf.Area (sq-ft)	Perim. (feet)	Inc.Store (cubic-feet)	Cum.Store (cubic-feet)	Wet.Area (sq-ft)
42.75	950	287.5	0	0	950
43.50	950	287.5	713	713	1,166

477361-00_PRE-&-POST_2020-04-20

Prepared by {enter your company name here}
 HydroCAD® 10.10-3a s/n 00866 © 2020 HydroCAD Software Solutions LLC

Elevation (feet)	Surf.Area (sq-ft)	Perim. (feet)	Inc.Store (cubic-feet)	Cum.Store (cubic-feet)	Wet.Area (sq-ft)
43.50	950	287.5	0	0	950
46.00	3,283	334.6	4,999	4,999	3,408
46.25	3,665	347.1	868	5,867	4,091

Device	Routing	Invert	Outlet Devices
#1	Primary	42.75'	15.0" Round Culvert L= 46.0' CMP, square edge headwall, Ke= 0.500 Inlet / Outlet Invert= 42.75' / 42.50' S= 0.0054 ' Cc= 0.900 n= 0.013 Corrugated PE, smooth interior, Flow Area= 1.23 sf
#2	Device 1	42.75'	0.5" Vert. Orifice C= 0.600 Limited to weir flow at low heads
#3	Device 2	43.50'	10.000 in/hr Exfiltration over Surface area
#4	Device 1	45.25'	12.0" Horiz. Beehive Grate C= 0.600 Limited to weir flow at low heads
#5	Secondary	45.50'	10.0' long x 4.0' breadth Broad-Crested Rectangular Weir Head (feet) 0.20 0.40 0.60 0.80 1.00 1.20 1.40 1.60 1.80 2.00 2.50 3.00 3.50 4.00 4.50 5.00 5.50 Coef. (English) 2.38 2.54 2.69 2.68 2.67 2.67 2.65 2.66 2.66 2.68 2.72 2.73 2.76 2.79 2.88 3.07 3.32

Primary OutFlow Max=0.5 cfs @ 12.49 hrs HW=45.39' TW=43.01' (Dynamic Tailwater)

- 1=Culvert (Passes 0.5 cfs of 7.9 cfs potential flow)
- 2=Orifice (Orifice Controls 0.0 cfs @ 7.42 fps)
- 3=Exfiltration (Passes 0.0 cfs of 0.6 cfs potential flow)
- 4=Beehive Grate (Weir Controls 0.5 cfs @ 1.21 fps)

Secondary OutFlow Max=0.0 cfs @ 0.00 hrs HW=42.75' TW=43.00' (Dynamic Tailwater)

- 5=Broad-Crested Rectangular Weir (Controls 0.0 cfs)

Summary for Pond PP05: Bloretention Pond #1

Inflow Area = 8,001 sf, 37.17% Impervious, Inflow Depth > 2.98" for 10-YR event
 Inflow = 0.5 cfs @ 12.16 hrs, Volume= 1,987 cf
 Outflow = 0.0 cfs @ 0.00 hrs, Volume= 0 cf, Atten= 100%, Lag= 0.0 min
 Primary = 0.0 cfs @ 0.00 hrs, Volume= 0 cf

Routing by Dyn-Stor-Ind method, Time Span= 0.00-24.00 hrs, dt= 0.06 hrs / 2
 Peak Elev= 56.80' @ 24.00 hrs Surf.Area= 1,584 sf Storage= 1,986 cf
 Flood Elev= 58.50' Surf.Area= 2,696 sf Storage= 5,552 cf

Plug-Flow detention time= (not calculated: initial storage exceeds outflow)
 Center-of-Mass det. time= (not calculated: no outflow)

Volume	Invert	Avail.Storage	Storage Description
#1	53.33'	5,552 cf	Custom Stage Data (Irregular) Listed below (Recalc)

Elevation (feet)	Surf.Area (sq-ft)	Perim. (feet)	Voids (%)	Inc.Store (cubic-feet)	Cum.Store (cubic-feet)	Wet.Area (sq-ft)
53.33	1,227	140.7	0.0	0	0	1,227
53.50	1,227	140.7	0.0	0	0	1,251
54.50	1,227	140.7	40.0	491	491	1,392
56.00	1,227	140.1	20.0	368	859	1,603
57.00	1,677	159.6	100.0	1,446	2,305	2,091
58.00	2,184	178.4	100.0	1,925	4,230	2,624
58.10	2,696	205.8	100.0	244	4,474	3,462
58.50	2,696	205.8	100.0	1,078	5,552	3,545

Device	Routing	Invert	Outlet Devices
#1	Primary	53.20'	12.0" Round Culvert L= 87.0' CPP, square edge headwall, Ke= 0.500 Inlet / Outlet Invert= 53.20' / 52.30' S= 0.0103 ' Cc= 0.900 n= 0.013 Corrugated PE, smooth interior, Flow Area= 0.79 sf
#2	Device 1	53.50'	0.2" Vert. Orifice/Grate X 0.00 C= 0.600 Limited to weir flow at low heads
#3	Device 1	57.50'	12.0" Horiz. Orifice/Grate C= 0.600 Limited to weir flow at low heads

Primary OutFlow Max=0.0 cfs @ 0.00 hrs HW=53.38' TW=51.30' (Dynamic Tailwater)

- 1=Culvert (Passes 0.0 cfs of 0.1 cfs potential flow)
- 2=Orifice/Grate (Controls 0.0 cfs)
- 3=Orifice/Grate (Controls 0.0 cfs)

Summary for Pond PP06: Wildlife Crossings

Inflow Area = 720,187 sf, 7.75% Impervious, Inflow Depth > 2.42" for 10-YR event
 Inflow = 17.3 cfs @ 12.82 hrs, Volume= 145,232 cf
 Outflow = 17.3 cfs @ 12.84 hrs, Volume= 145,209 cf, Atten= 0%, Lag= 0.8 min
 Primary = 12.8 cfs @ 12.84 hrs, Volume= 131,684 cf
 Secondary = 4.5 cfs @ 12.84 hrs, Volume= 13,525 cf
 Tertiary = 0.0 cfs @ 0.00 hrs, Volume= 0 cf

Routing by Dyn-Stor-Ind method, Time Span= 0.00-24.00 hrs, dt= 0.06 hrs / 2
 Peak Elev= 26.76' @ 12.84 hrs Surf.Area= 1,373 sf Storage= 527 cf

Plug-Flow detention time= 0.4 min calculated for 145,209 cf (100% of inflow)
 Center-of-Mass det. time= 0.4 min (898.4 - 898.0)

477361-00_PRE-&-POST_2020-04-20

Prepared by {enter your company name here}
 HydroCAD® 10.10-3a s/n 00866 © 2020 HydroCAD Software Solutions LLC

Volume	Invert	Avail.Storage	Storage Description
#1	25.50'	7,358 cf	Custom Stage Data (Irregular) Listed below (Recalc)

Elevation (feet)	Surf.Area (sq-ft)	Perim. (feet)	Inc.Store (cubic-feet)	Cum.Store (cubic-feet)	Wet.Area (sq-ft)
25.50	10	40.0	0	0	10
26.00	141	144.3	31	31	1,540
27.00	2,025	318.1	900	932	7,940
28.00	12,270	467.3	6,427	7,358	17,273

Device	Routing	Invert	Outlet Devices
#1	Primary	25.80'	60.0" W x 23.0" H Box Culvert L= 31.5' RCP, square edge headwall, Ke= 0.500 Inlet / Outlet Invert= 25.80' / 25.70' S= 0.0032 ' Cc= 0.900 n= 0.011 Concrete pipe, straight & clean, Flow Area= 9.58 sf
#2	Secondary	26.30'	60.0" W x 24.0" H Box Culvert L= 31.5' RCP, square edge headwall, Ke= 0.500 Inlet / Outlet Invert= 26.30' / 26.20' S= 0.0032 ' Cc= 0.900 n= 0.011 Concrete pipe, straight & clean, Flow Area= 10.00 sf
#3	Tertiary	26.80'	60.0" W x 26.0" H Box Culvert L= 31.5' RCP, square edge headwall, Ke= 0.500 Inlet / Outlet Invert= 26.80' / 26.70' S= 0.0032 ' Cc= 0.900 n= 0.011 Concrete pipe, straight & clean, Flow Area= 10.83 sf
#4	Tertiary	27.50'	50.0' long x 35.0' breadth Broad-Crested Rectangular Weir Head (feet) 0.20 0.40 0.60 0.80 1.00 1.20 1.40 1.60 Coef. (English) 2.68 2.70 2.70 2.64 2.63 2.64 2.64 2.63

Primary OutFlow Max=12.8 cfs @ 12.84 hrs HW=26.76' TW=25.89' (Dynamic Tailwater)
 ↖**1=Culvert** (Barrel Controls 12.8 cfs @ 3.55 fps)

Secondary OutFlow Max=4.5 cfs @ 12.84 hrs HW=26.76' TW=25.89' (Dynamic Tailwater)
 ↖**2=Culvert** (Barrel Controls 4.5 cfs @ 2.60 fps)

Tertiary OutFlow Max=0.0 cfs @ 0.00 hrs HW=25.50' TW=25.70' (Dynamic Tailwater)
 ↖**3=Culvert** (Controls 0.0 cfs)
 ↖**4=Broad-Crested Rectangular Weir** (Controls 0.0 cfs)

Summary for Pond PP07: Infiltration Basin #1

Inflow Area = 5,845 sf, 18.63% Impervious, Inflow Depth > 3.17" for 10-YR event
 Inflow = 0.5 cfs @ 12.09 hrs, Volume= 1,545 cf
 Outflow = 0.2 cfs @ 12.30 hrs, Volume= 972 cf, Atten= 51%, Lag= 12.3 min
 Discarded = 0.0 cfs @ 12.30 hrs, Volume= 236 cf
 Primary = 0.2 cfs @ 12.30 hrs, Volume= 736 cf

Routing by Dyn-Stor-Ind method, Time Span= 0.00-24.00 hrs, dt= 0.06 hrs / 2
 Peak Elev= 45.56' @ 12.30 hrs Surf.Area= 753 sf Storage= 619 cf
 Flood Elev= 46.50' Surf.Area= 1,323 sf Storage= 1,589 cf

Plug-Flow detention time= 180.0 min calculated for 972 cf (63% of inflow)
 Center-of-Mass det. time= 75.3 min (899.1 - 823.7)

Volume	Invert	Avail.Storage	Storage Description
#1	44.00'	1,589 cf	Custom Stage Data (Irregular) Listed below (Recalc)

Elevation (feet)	Surf.Area (sq-ft)	Perim. (feet)	Inc.Store (cubic-feet)	Cum.Store (cubic-feet)	Wet.Area (sq-ft)
44.00	126	73.9	0	0	126
46.00	1,022	144.0	1,005	1,005	1,361
46.50	1,323	156.6	585	1,589	1,672

Device	Routing	Invert	Outlet Devices
#1	Primary	45.50'	6.0' long x 4.0' breadth Broad-Crested Rectangular Weir Head (feet) 0.20 0.40 0.60 0.80 1.00 1.20 1.40 1.60 1.80 2.00 2.50 3.00 3.50 4.00 4.50 5.00 5.50 Coef. (English) 2.38 2.54 2.69 2.68 2.67 2.67 2.65 2.66 2.66 2.68 2.72 2.73 2.76 2.79 2.88 3.07 3.32
#2	Discarded	44.00'	0.300 in/hr Exfiltration over Surface area

Discarded OutFlow Max=0.0 cfs @ 12.30 hrs HW=45.56' (Free Discharge)
 ↖**2=Exfiltration** (Exfiltration Controls 0.0 cfs)

Primary OutFlow Max=0.2 cfs @ 12.30 hrs HW=45.56' TW=42.00' (Dynamic Tailwater)
 ↖**1=Broad-Crested Rectangular Weir** (Weir Controls 0.2 cfs @ 0.60 fps)

Summary for Pond PP08: Infiltration Basin #2

Inflow Area = 14,865 sf, 8.98% Impervious, Inflow Depth > 2.69" for 10-YR event
 Inflow = 0.5 cfs @ 12.57 hrs, Volume= 3,327 cf
 Outflow = 0.1 cfs @ 14.67 hrs, Volume= 1,262 cf, Atten= 86%, Lag= 126.2 min
 Discarded = 0.0 cfs @ 14.67 hrs, Volume= 559 cf
 Primary = 0.1 cfs @ 14.67 hrs, Volume= 703 cf

Routing by Dyn-Stor-Ind method, Time Span= 0.00-24.00 hrs, dt= 0.06 hrs / 2
 Peak Elev= 64.53' @ 14.67 hrs Surf.Area= 1,706 sf Storage= 2,103 cf
 Flood Elev= 65.50' Surf.Area= 2,446 sf Storage= 4,056 cf

Plug-Flow detention time= 291.0 min calculated for 1,259 cf (38% of inflow)
 Center-of-Mass det. time= 166.3 min (1,029.3 - 863.1)

477361-00_PRE-&-POST_2020-04-20

Prepared by {enter your company name here}
 HydroCAD® 10.10-3a s/n 00866 © 2020 HydroCAD Software Solutions LLC

Volume	Invert	Avail.Storage	Storage Description
#1	63.00'	4,056 cf	Custom Stage Data (Irregular) Listed below (Recalc)

Elevation (feet)	Surf.Area (sq-ft)	Perim. (feet)	Inc.Store (cubic-feet)	Cum.Store (cubic-feet)	Wet.Area (sq-ft)
63.00	1,074	124.1	0	0	1,074
65.00	1,932	161.8	2,964	2,964	1,978
65.50	2,446	180.7	1,092	4,056	2,500

Device	Routing	Invert	Outlet Devices
#1	Primary	64.50'	6.0' long x 6.0' breadth Broad-Crested Rectangular Weir Head (feet) 0.20 0.40 0.60 0.80 1.00 1.20 1.40 1.60 1.80 2.00 2.50 3.00 3.50 4.00 4.50 5.00 5.50 Coef. (English) 2.37 2.51 2.70 2.68 2.68 2.67 2.65 2.65 2.65 2.65 2.66 2.66 2.67 2.69 2.72 2.76 2.83
#2	Discarded	63.00'	0.300 in/hr Exfiltration over Surface area

Discarded OutFlow Max=0.0 cfs @ 14.67 hrs HW=64.53' (Free Discharge)
 ↳2=Exfiltration (Exfiltration Controls 0.0 cfs)

Primary OutFlow Max=0.1 cfs @ 14.67 hrs HW=64.53' TW=62.00' (Dynamic Tailwater)
 ↳1=Broad-Crested Rectangular Weir (Weir Controls 0.1 cfs @ 0.38 fps)

Summary for Link PPol01: Pr Pol-01

Inflow Area = 2,940,052 sf, 4.04% Impervious, Inflow Depth > 1.86" for 10-YR event
 Inflow = 21.6 cfs @ 14.25 hrs, Volume= 456,403 cf
 Primary = 21.6 cfs @ 14.25 hrs, Volume= 456,403 cf, Atten= 0%, Lag= 0.0 min

Primary outflow = Inflow, Time Span= 0.00-24.00 hrs, dt= 0.06 hrs

Summary for Link PPol02: Pr Pol-02

Inflow Area = 57,405 sf, 0.00% Impervious, Inflow Depth > 1.75" for 10-YR event
 Inflow = 1.1 cfs @ 12.78 hrs, Volume= 8,366 cf
 Primary = 1.1 cfs @ 12.78 hrs, Volume= 8,366 cf, Atten= 0%, Lag= 0.0 min

Primary outflow = Inflow, Time Span= 0.00-24.00 hrs, dt= 0.06 hrs

Summary for Link PPol03: Proposed Wildlife Crossings

Inflow Area = 720,187 sf, 7.75% Impervious, Inflow Depth > 2.42" for 10-YR event
 Inflow = 17.3 cfs @ 12.82 hrs, Volume= 145,232 cf
 Primary = 17.3 cfs @ 12.82 hrs, Volume= 145,232 cf, Atten= 0%, Lag= 0.0 min

Primary outflow = Inflow, Time Span= 0.00-24.00 hrs, dt= 0.06 hrs

APPENDIX F
BMP WORKSHEETS

(This Page Is Intentionally Blank)



FILTRATION PRACTICE DESIGN CRITERIA (Env-Wq 1508.07)

Type/Node Name: _____

PP03a R-Tanks 1 and 2

Enter the type of filtration practice (e.g., bioretention system) and the node name in the drainage analysis, if applicable

		Have you reviewed the restrictions on unlined systems outlined in Env-Wq 1508.07(a)?	
0.36	ac	A = Area draining to the practice	
0.16	ac	A _I = Impervious area draining to the practice	
0.44	decimal	I = percent impervious area draining to the practice, in decimal form	
0.44	unitless	R _v = Runoff coefficient = 0.05 + (0.9 x I)	
0.16	ac-in	WQV = 1" x R _v x A	
572	cf	WQV conversion (ac-in x 43,560 sf/ac x 1ft/12")	
143	cf	25% x WQV (check calc for sediment forebay volume)	
429	cf	75% x WQV (check calc for surface sand filter volume)	
Deep Sump CB		Method of Pretreatment? (not required for clean or roof runoff)	
NA	cf	V _{SED} = sediment forebay volume, if used for pretreatment	← ≥ 25%WQV
1,476	sf	A _{SA} = surface area of the practice	
NA	iph	K _{sat} DESIGN = design infiltration rate ¹	
Yes	Yes/No	If K _{sat} (prior to factor of safety) is < 0.50 iph, has an underdrain been provided?	
-	hours	T _{DRAIN} = drain time = V / (A _{SA} * I _{DESIGN})	← ≤ 72-hrs
30.45	feet	E _{FC} = elevation of the bottom of the filter course material ²	
29.45	feet	E _{UD} = invert elevation of the underdrain (UD), if applicable	
NA	feet	E _{SHWT} = elevation of SHWT (if none found, enter the lowest elevation of the test pit)	
NA	feet	E _{ROCK} = elevation of bedrock (if none found, enter the lowest elevation of the test pit)	
1.00	feet	D _{FC to UD} = depth to UD from the bottom of the filter course	← ≥ 1'
#VALUE!	feet	D _{FC to ROCK} = depth to bedrock from the bottom of the filter course	← ≥ 1'
#VALUE!	feet	D _{FC to SHWT} = depth to SHWT from the bottom of the filter course	← ≥ 1'
34.16	ft	Peak elevation of the 50-year storm event (infiltration can be used in analysis)	
35.40	ft	Elevation of the top of the practice	
YES		50 peak elevation ≤ Elevation of the top of the practice	← yes

If a surface sand filter or underground sand filter is proposed:

YES	ac	Drainage Area check.	← < 10 ac
3,487	cf	V = volume of storage ³ (attach a stage-storage table)	← ≥ 75%WQV
18.0	inches	D _{FC} = filter course thickness	← 18", or 24" if within GPA
Sheet	C-35	Note what sheet in the plan set contains the filter course specification	
Yes	Yes/No	Access grate provided?	← yes

Stage-Area-Storage for Pond PP03a: R-Tank #1 and 2

Elevation (feet)	Surface (sq-ft)	Storage (cubic-feet)	Elevation (feet)	Surface (sq-ft)	Storage (cubic-feet)
29.45	1,476	0	34.75	4,218	4,648
29.55	1,476	60	34.85	4,268	4,759
29.65	1,476	121	34.95	4,318	4,873
29.75	1,476	181	35.05	4,369	4,989
29.85	1,476	241	35.15	4,419	5,107
29.95	1,476	302	35.25	4,471	5,226
30.05	1,476	362	35.35	4,522	5,347
30.15	1,476	422	35.45	4,563	5,446
30.25	1,476	482	35.55	4,563	5,446
30.35	1,476	543	35.65	4,563	5,446
30.45	1,476	603	35.75	4,563	5,446
30.55	1,476	634	35.85	4,563	5,446
30.65	1,476	665	35.95	4,563	5,446
30.75	1,476	695	36.05	4,563	5,446
30.85	1,476	726	36.15	4,563	5,446
30.95	1,476	757	36.25	4,563	5,446
31.05	1,476	788	36.35	4,563	5,446
31.15	1,476	818	36.45	4,563	5,446
31.25	1,476	849	36.55	4,563	5,446
31.35	1,476	880	36.65	4,563	5,446
31.45	1,476	911	36.75	4,563	5,446
31.55	1,476	942	36.85	4,563	5,446
31.65	1,476	972	36.95	4,563	5,446
31.75	1,476	1,003	37.05	4,563	5,446
31.85	1,476	1,034	37.15	4,563	5,446
31.95	2,953	1,065			
32.05	2,993	1,126			
32.15	3,035	1,189			
32.25	3,076	1,280			
32.35	3,118	1,400			
32.45	3,160	1,522			
32.55	3,203	1,646			
32.65	3,245	1,771			
32.75	3,289	1,898			
32.85	3,332	2,027			
32.95	3,376	2,158			
33.05	3,420	2,290			
33.15	3,464	2,424			
33.25	3,509	2,560			
33.35	3,554	2,698			
33.45	3,599	2,837			
33.55	3,645	2,978			
33.65	3,691	3,121			
33.75	3,737	3,266			
33.85	3,784	3,413			
33.95	3,831	3,562			
34.05	3,878	3,713			
34.15	3,926	3,865			
34.25	3,974	4,019			
34.35	4,022	4,176			
34.45	4,071	4,324			
34.55	4,119	4,430			
34.65	4,169	4,538			

(This page is intentionally blank)



FILTRATION PRACTICE DESIGN CRITERIA (Env-Wq 1508.07)

Type/Node Name: PP03b R-Tanks 3 and 4

Enter the type of filtration practice (e.g., bioretention system) and the node name in the drainage analysis, if applicable

Yes		Have you reviewed the restrictions on unlined systems outlined in Env-Wq 1508.07(a)?	
0.50	ac	A = Area draining to the practice	
0.26	ac	A _I = Impervious area draining to the practice	
0.52	decimal	I = percent impervious area draining to the practice, in decimal form	
0.52	unitless	R _v = Runoff coefficient = 0.05 + (0.9 x I)	
0.26	ac-in	WQV = 1" x R _v x A	
932	cf	WQV conversion (ac-in x 43,560 sf/ac x 1ft/12")	
233	cf	25% x WQV (check calc for sediment forebay volume)	
699	cf	75% x WQV (check calc for surface sand filter volume)	
Deep Sump CB		Method of Pretreatment? (not required for clean or roof runoff)	
NA	cf	V _{SED} = sediment forebay volume, if used for pretreatment	← ≥ 25%WQV
1,204	sf	A _{SA} = surface area of the practice	
NA	iph	K _{sat} _{DESIGN} = design infiltration rate ¹	
Yes	Yes/No	If K _{sat} (prior to factor of safety) is < 0.50 iph, has an underdrain been provided?	
-	hours	T _{DRAIN} = drain time = V / (A _{SA} * I _{DESIGN})	← ≤ 72-hrs
31.20	feet	E _{FC} = elevation of the bottom of the filter course material ²	
30.20	feet	E _{UD} = invert elevation of the underdrain (UD), if applicable	
NA	feet	E _{SHWT} = elevation of SHWT (if none found, enter the lowest elevation of the test pit)	
NA	feet	E _{ROCK} = elevation of bedrock (if none found, enter the lowest elevation of the test pit)	
1.00	feet	D _{FC to UD} = depth to UD from the bottom of the filter course	← ≥ 1'
#VALUE!	feet	D _{FC to ROCK} = depth to bedrock from the bottom of the filter course	← ≥ 1'
#VALUE!	feet	D _{FC to SHWT} = depth to SHWT from the bottom of the filter course	← ≥ 1'
37.48	ft	Peak elevation of the 50-year storm event (infiltration can be used in analysis)	
38.35	ft	Elevation of the top of the practice	
YES		50 peak elevation ≤ Elevation of the top of the practice	← yes

If a surface sand filter or underground sand filter is proposed:

YES	ac	Drainage Area check.	← < 10 ac
4,414	cf	V = volume of storage ³ (attach a stage-storage table)	← ≥ 75%WQV
15.0	inches	D _{FC} = filter course thickness	← 18", or 24" if within GPA
Sheet	C-35	Note what sheet in the plan set contains the filter course specification	
Yes	Yes/No	Access grate provided?	← yes

Stage-Area-Storage for Pond PP03b: R-Tank #3 and 4

Elevation (feet)	Surface (sq-ft)	Storage (cubic-feet)	Elevation (feet)	Surface (sq-ft)	Storage (cubic-feet)
30.20	1,204	0	35.50	3,464	3,932
30.30	1,204	49	35.60	3,507	4,067
30.40	1,204	99	35.70	3,549	4,205
30.50	1,204	148	35.80	3,592	4,344
30.60	1,204	198	35.90	3,636	4,485
30.70	1,204	247	36.00	3,679	4,627
30.80	1,204	297	36.10	3,723	4,770
30.90	1,204	346	36.20	3,768	4,915
31.00	1,204	395	36.30	3,812	5,062
31.10	1,204	445	36.40	3,857	5,210
31.20	1,204	494	36.50	3,902	5,361
31.30	1,204	520	36.60	3,948	5,513
31.40	1,204	545	36.70	3,994	5,667
31.50	1,204	570	36.80	4,040	5,823
31.60	1,204	596	36.90	4,086	5,980
31.70	1,204	621	37.00	4,133	6,140
31.80	1,204	646	37.10	4,180	6,301
31.90	1,204	672	37.20	4,228	6,465
32.00	1,204	697	37.30	4,276	6,630
32.10	1,204	722	37.40	4,324	6,774
32.20	1,204	748	37.50	4,372	6,900
32.30	1,204	773	37.60	4,421	7,027
32.40	1,204	798	37.70	4,470	7,157
32.50	1,204	824	37.80	4,519	7,288
32.60	1,204	849	37.90	4,569	7,422
32.70	2,409	874	38.00	4,619	7,558
32.80	2,442	925	38.10	4,669	7,695
32.90	2,476	976	38.20	4,720	7,835
33.00	2,510	1,050	38.30	4,771	7,976
33.10	2,544	1,148	38.40	4,797	8,046
33.20	2,579	1,247	38.50	4,797	8,046
33.30	2,614	1,347	38.60	4,797	8,046
33.40	2,649	1,449	38.70	4,797	8,046
33.50	2,685	1,552	38.80	4,797	8,046
33.60	2,721	1,656	38.90	4,797	8,046
33.70	2,757	1,762	39.00	4,797	8,046
33.80	2,794	1,870	39.10	4,797	8,046
33.90	2,830	1,979	39.20	4,797	8,046
34.00	2,868	2,089	39.30	4,797	8,046
34.10	2,905	2,201	39.40	4,797	8,046
34.20	2,943	2,314	39.50	4,797	8,046
34.30	2,981	2,429	39.60	4,797	8,046
34.40	3,020	2,546	39.70	4,797	8,046
34.50	3,059	2,664	39.80	4,797	8,046
34.60	3,098	2,783			
34.70	3,137	2,904			
34.80	3,177	3,027			
34.90	3,217	3,151			
35.00	3,258	3,277			
35.10	3,298	3,405			
35.20	3,339	3,534			
35.30	3,381	3,665			
35.40	3,422	3,797			

(This page is intentionally blank)



FILTRATION PRACTICE DESIGN CRITERIA (Env-Wq 1508.07)

Type/Node Name: PP-04a Hybrid BIORETENTION AREA #2

Enter the type of filtration practice (e.g., bioretention system) and the node name in the drainage analysis, if applicable

		Have you reviewed the restrictions on unlined systems outlined in Env-Wq 1508.07(a)?	
0.97	ac	A = Area draining to the practice	
0.46	ac	A _I = Impervious area draining to the practice	
0.47	decimal	I = percent impervious area draining to the practice, in decimal form	
0.47	unitless	R _v = Runoff coefficient = 0.05 + (0.9 x I)	
0.46	ac-in	WQV = 1" x R _v x A	
1,675	cf	WQV conversion (ac-in x 43,560 sf/ac x 1ft/12")	
419	cf	25% x WQV (check calc for sediment forebay volume)	
1,256	cf	75% x WQV (check calc for surface sand filter volume)	
Deep Sump		Method of Pretreatment? (not required for clean or roof runoff)	
-	cf	V _{SED} = sediment forebay volume, if used for pretreatment	← ≥ 25%WQV
1,132	sf	A _{SA} = surface area of the practice	
NA	iph	K _{sat} _{DESIGN} = design infiltration rate ¹	
Yes	Yes/No	If K _{sat} (prior to factor of safety) is < 0.50 iph, has an underdrain been provided?	
-	hours	T _{DRAIN} = drain time = V / (A _{SA} * I _{DESIGN})	← ≤ 72-hrs
44.50	feet	E _{FC} = elevation of the bottom of the filter course material ²	
42.50	feet	E _{UD} = invert elevation of the underdrain (UD), if applicable	
NA	feet	E _{SHWT} = elevation of SHWT (if none found, enter the lowest elevation of the test pit)	
NA	feet	E _{ROCK} = elevation of bedrock (if none found, enter the lowest elevation of the test pit)	
2.00	feet	D _{FC to UD} = depth to UD from the bottom of the filter course	← ≥ 1'
#VALUE!	feet	D _{FC to ROCK} = depth to bedrock from the bottom of the filter course	← ≥ 1'
#VALUE!	feet	D _{FC to SHWT} = depth to SHWT from the bottom of the filter course	← ≥ 1'
48.19	ft	Peak elevation of the 50-year storm event (infiltration can be used in analysis)	
48.75	ft	Elevation of the top of the practice	
YES		50 peak elevation ≤ Elevation of the top of the practice	← yes

If a surface sand filter or underground sand filter is proposed:

YES	ac	Drainage Area check.	← < 10 ac
	cf	V = volume of storage ³ (attach a stage-storage table)	← ≥ 75%WQV
	inches	D _{FC} = filter course thickness	← 18", or 24" if within GPA
Sheet		Note what sheet in the plan set contains the filter course specification	
Yes/No		Access grate provided?	← yes

Stage-Area-Storage for Pond PP04A: Bioretention Area #2

Elevation (feet)	Surface (sq-ft)	Storage (cubic-feet)	Elevation (feet)	Surface (sq-ft)	Storage (cubic-feet)
45.25	0	0	47.90	3,017	4,053
45.30	0	17	47.95	3,079	4,205
45.35	0	34	48.00	3,141	4,360
45.40	0	51	48.05	3,204	4,519
45.45	0	68	48.10	3,268	4,681
45.50	0	85	48.15	3,332	4,846
45.55	0	102	48.20	3,397	5,014
45.60	0	119	48.25	3,463	5,186
45.65	0	136	48.30	3,529	5,360
45.70	0	153	48.35	3,596	5,538
45.75	0	170	48.40	3,663	5,720
45.80	0	187	48.45	3,731	5,905
45.85	0	204	48.50	3,800	6,093
45.90	0	221	48.55	3,978	6,287
45.95	0	238	48.60	4,159	6,491
46.00	1,132	255	48.65	4,345	6,703
46.05	1,170	312	48.70	4,535	6,925
46.10	1,209	372	48.75	4,729	7,157
46.15	1,248	433	48.80	4,729	7,157
46.20	1,288	497	48.85	4,729	7,157
46.25	1,328	562	48.90	4,729	7,157
46.30	1,369	629	48.95	4,729	7,157
46.35	1,411	699	49.00	4,729	7,157
46.40	1,454	770			
46.45	1,497	844			
46.50	1,540	920			
46.55	1,584	998			
46.60	1,629	1,079			
46.65	1,675	1,161			
46.70	1,721	1,246			
46.75	1,768	1,333			
46.80	1,815	1,423			
46.85	1,863	1,515			
46.90	1,912	1,609			
46.95	1,961	1,706			
47.00	2,011	1,805			
47.05	2,062	1,907			
47.10	2,113	2,011			
47.15	2,165	2,118			
47.20	2,217	2,228			
47.25	2,270	2,340			
47.30	2,324	2,455			
47.35	2,378	2,573			
47.40	2,433	2,693			
47.45	2,488	2,816			
47.50	2,545	2,942			
47.55	2,601	3,070			
47.60	2,659	3,202			
47.65	2,717	3,336			
47.70	2,776	3,473			
47.75	2,835	3,614			
47.80	2,895	3,757			
47.85	2,955	3,903			

(This page is intentionally blank)



FILTRATION PRACTICE DESIGN CRITERIA (Env-Wq 1508.07)

Type/Node Name: _____

PP-04b BIORETENTION AREA #3

Enter the type of filtration practice (e.g., bioretention system) and the node name in the drainage analysis, if applicable

		Have you reviewed the restrictions on unlined systems outlined in Env-Wq 1508.07(a)?	
0.48	ac	A = Area draining to the practice	
0.22	ac	A _I = Impervious area draining to the practice	
0.47	decimal	I = percent impervious area draining to the practice, in decimal form	
0.47	unitless	R _v = Runoff coefficient = 0.05 + (0.9 x I)	
0.23	ac-in	WQV = 1" x R _v x A	
822	cf	WQV conversion (ac-in x 43,560 sf/ac x 1ft/12")	
205	cf	25% x WQV (check calc for sediment forebay volume)	
616	cf	75% x WQV (check calc for surface sand filter volume)	
Deep Sump CB		Method of Pretreatment? (not required for clean or roof runoff)	
NA	cf	V _{SED} = sediment forebay volume, if used for pretreatment	← ≥ 25%WQV
950	sf	A _{SA} = surface area of the practice	
NA	iph	K _{sat} DESIGN = design infiltration rate ¹	
Yes	Yes/No	If K _{sat} (prior to factor of safety) is < 0.50 iph, has an underdrain been provided?	
-	hours	T _{DRAIN} = drain time = V / (A _{SA} * I _{DESIGN})	← ≤ 72-hrs
42.00	feet	E _{FC} = elevation of the bottom of the filter course material ²	
40.00	feet	E _{UD} = invert elevation of the underdrain (UD), if applicable	
NA	feet	E _{SHWT} = elevation of SHWT (if none found, enter the lowest elevation of the test pit)	
NA	feet	E _{ROCK} = elevation of bedrock (if none found, enter the lowest elevation of the test pit)	
2.00	feet	D _{FC to UD} = depth to UD from the bottom of the filter course	← ≥ 1'
#VALUE!	feet	D _{FC to ROCK} = depth to bedrock from the bottom of the filter course	← ≥ 1'
#VALUE!	feet	D _{FC to SHWT} = depth to SHWT from the bottom of the filter course	← ≥ 1'
45.60	ft	Peak elevation of the 50-year storm event (infiltration can be used in analysis)	
46.00	ft	Elevation of the top of the practice	
YES		50 peak elevation ≤ Elevation of the top of the practice	← yes

If a surface sand filter or underground sand filter is proposed:

YES	ac	Drainage Area check.	← < 10 ac
	cf	V = volume of storage ³ (attach a stage-storage table)	← ≥ 75%WQV
	inches	D _{FC} = filter course thickness	← 18", or 24" if within GPA
Sheet		Note what sheet in the plan set contains the filter course specification	
	Yes/No	Access grate provided?	← yes

Stage-Area-Storage for Pond PP04B: Bioretention Area #3

Elevation (feet)	Surface (sq-ft)	Storage (cubic-feet)	Elevation (feet)	Surface (sq-ft)	Storage (cubic-feet)
42.75	0	0	45.40	2,595	3,454
42.80	0	14	45.45	2,649	3,585
42.85	0	29	45.50	2,704	3,718
42.90	0	43	45.55	2,760	3,855
42.95	0	57	45.60	2,816	3,994
43.00	0	71	45.65	2,872	4,137
43.05	0	85	45.70	2,929	4,282
43.10	0	100	45.75	2,987	4,430
43.15	0	114	45.80	3,045	4,580
43.20	0	128	45.85	3,103	4,734
43.25	0	143	45.90	3,163	4,891
43.30	0	157	45.95	3,223	5,050
43.35	0	171	46.00	3,283	5,213
43.40	0	185	46.05	3,358	5,379
43.45	0	200	46.10	3,433	5,549
43.50	950	214	46.15	3,510	5,722
43.55	983	262	46.20	3,587	5,900
43.60	1,016	312	46.25	3,665	6,081
43.65	1,050	364	46.30	3,665	6,081
43.70	1,085	417	46.35	3,665	6,081
43.75	1,120	472	46.40	3,665	6,081
43.80	1,156	529	46.45	3,665	6,081
43.85	1,192	588	46.50	3,665	6,081
43.90	1,229	648			
43.95	1,266	711			
44.00	1,304	775			
44.05	1,343	841			
44.10	1,382	909			
44.15	1,422	979			
44.20	1,462	1,052			
44.25	1,503	1,126			
44.30	1,544	1,202			
44.35	1,586	1,280			
44.40	1,628	1,360			
44.45	1,671	1,443			
44.50	1,715	1,528			
44.55	1,759	1,614			
44.60	1,804	1,703			
44.65	1,849	1,795			
44.70	1,895	1,888			
44.75	1,941	1,984			
44.80	1,988	2,083			
44.85	2,036	2,183			
44.90	2,084	2,286			
44.95	2,132	2,391			
45.00	2,182	2,499			
45.05	2,231	2,610			
45.10	2,282	2,722			
45.15	2,332	2,838			
45.20	2,384	2,956			
45.25	2,436	3,076			
45.30	2,488	3,199			
45.35	2,542	3,325			

(This page is intentionally blank)



FILTRATION PRACTICE DESIGN CRITERIA (Env-Wq 1508.07)

Type/Node Name: _____

PP-05 BIORETENTION AREA #1

Enter the type of filtration practice (e.g., bioretention system) and the node name in the drainage analysis, if applicable

		Have you reviewed the restrictions on unlined systems outlined in Env-Wq 1508.07(a)?	
0.18	ac	A = Area draining to the practice	
0.07	ac	A _I = Impervious area draining to the practice	
0.37	decimal	I = percent impervious area draining to the practice, in decimal form	
0.38	unitless	R _v = Runoff coefficient = 0.05 + (0.9 x I)	
0.07	ac-in	WQV = 1" x R _v x A	
256	cf	WQV conversion (ac-in x 43,560 sf/ac x 1ft/12")	
64	cf	25% x WQV (check calc for sediment forebay volume)	
192	cf	75% x WQV (check calc for surface sand filter volume)	
	Forebay	Method of Pretreatment? (not required for clean or roof runoff)	
140	cf	V _{SED} = sediment forebay volume, if used for pretreatment	← ≥ 25%WQV
1,227	sf	A _{SA} = surface area of the practice	
NA	iph	K _{sat} DESIGN = design infiltration rate ¹	
Yes	Yes/No	If K _{sat} (prior to factor of safety) is < 0.50 iph, has an underdrain been provided?	
-	hours	T _{DRAIN} = drain time = V / (A _{SA} * I _{DESIGN})	← ≤ 72-hrs
54.50	feet	E _{FC} = elevation of the bottom of the filter course material ²	
53.50	feet	E _{UD} = invert elevation of the underdrain (UD), if applicable	
NA	feet	E _{SHWT} = elevation of SHWT (if none found, enter the lowest elevation of the test pit)	
NA	feet	E _{ROCK} = elevation of bedrock (if none found, enter the lowest elevation of the test pit)	
1.00	feet	D _{FC to UD} = depth to UD from the bottom of the filter course	← ≥ 1'
#VALUE!	feet	D _{FC to ROCK} = depth to bedrock from the bottom of the filter course	← ≥ 1'
#VALUE!	feet	D _{FC to SHWT} = depth to SHWT from the bottom of the filter course	← ≥ 1'
57.52	ft	Peak elevation of the 50-year storm event (infiltration can be used in analysis)	
58.00	ft	Elevation of the top of the practice	
YES		50 peak elevation ≤ Elevation of the top of the practice	← yes

If a surface sand filter or underground sand filter is proposed:

YES	ac	Drainage Area check.	← < 10 ac
	cf	V = volume of storage ³ (attach a stage-storage table)	← ≥ 75%WQV
	inches	D _{FC} = filter course thickness	← 18", or 24" if within GPA
Sheet		Note what sheet in the plan set contains the filter course specification	
	Yes/No	Access grate provided?	← yes

Stage-Area-Storage for Pond PP05: Bloretention Pond #1

Elevation (feet)	Surface (sq-ft)	Storage (cubic-feet)
53.33	1,227	0
53.43	1,227	0
53.53	1,227	15
53.63	1,227	64
53.73	1,227	113
53.83	1,227	162
53.93	1,227	211
54.03	1,227	260
54.13	1,227	309
54.23	1,227	358
54.33	1,227	407
54.43	1,227	456
54.53	1,227	498
54.63	1,227	523
54.73	1,227	547
54.83	1,227	572
54.93	1,227	596
55.03	1,227	621
55.13	1,227	645
55.23	1,227	670
55.33	1,227	694
55.43	1,227	719
55.53	1,227	744
55.63	1,227	768
55.73	1,227	793
55.83	1,227	817
55.93	1,227	842
56.03	1,239	896
56.13	1,282	1,022
56.23	1,324	1,152
56.33	1,368	1,287
56.43	1,412	1,426
56.53	1,457	1,569
56.63	1,502	1,717
56.73	1,549	1,870
56.83	1,596	2,027
56.93	1,643	2,189
57.03	1,691	2,356
57.13	1,739	2,527
57.23	1,788	2,703
57.33	1,837	2,885
57.43	1,887	3,071
57.53	1,937	3,262
57.63	1,989	3,458
57.73	2,041	3,660
57.83	2,093	3,866
57.93	2,146	4,078
58.03	2,332	4,298
58.13	2,696	4,554
58.23	2,696	4,824
58.33	2,696	5,094
58.43	2,696	5,363

(This page is intentionally blank)



INFILTRATION PRACTICE CRITERIA (Env-Wq 1508.06)

Type/Node Name: **PP07 - Infiltration Basin #1**

Enter the type of infiltration practice (e.g., basin, trench) and the node name in the drainage analysis, if applicable

Yes	Have you reviewed Env-Wq 1508.06(a) to ensure that infiltration is allowed?	
0.13 ac	A = Area draining to the practice	
0.02 ac	A _I = Impervious area draining to the practice	
0.19 decimal	I = percent impervious area draining to the practice, in decimal form	
0.22 unitless	R _v = Runoff coefficient = 0.05 + (0.9 x I)	
0.03 ac-in	WQV = 1" x R _v x A	
106 cf	WQV conversion (ac-in x 43,560 sf/ac x 1ft/12")	
27 cf	25% x WQV (check calc for sediment forebay volume)	
NA	Method of pretreatment? (not required for clean or roof runoff)	
NA cf	V _{SED} = sediment forebay volume, if used for pretreatment	← ≥ 25%WQV
572 cf	V = volume ¹ (attach a stage-storage table)	← ≥ WQV
126 sf	A _{SA} = surface area of the bottom of the pond	
0.30 iph	K _{satDESIGN} = design infiltration rate ²	
33.7 hours	T _{DRAIN} = drain time = V / (A _{SA} * I _{DESIGN})	← ≤ 72-hrs
44.00 feet	E _{BTM} = elevation of the bottom of the basin	
42.80 feet	E _{SHWT} = elevation of SHWT (if none found, enter the lowest elevation of the test pit)	
42.80 feet	E _{ROCK} = elevation of bedrock (if none found, enter the lowest elevation of the test pit)	
1.20 feet	D _{SHWT} = separation from SHWT	← ≥ * ³
1.2 feet	D _{ROCK} = separation from bedrock	← ≥ * ³
NA ft	D _{amend} = Depth of amended soil, if applicable due high infiltration rate	← ≥ 24"
ft	D _T = depth of trench, if trench proposed	← 4 - 10 ft
Yes/No	If a trench or underground system is proposed, observation well provided ⁴	
	If a trench is proposed, material in trench	
	If a basin is proposed, basin floor material	
Yes/No	If a basin is proposed, the perimeter should be curvilinear, basin floor shall be flat.	
:1	If a basin is proposed, pond side slopes	← ≥3:1
45.56 ft	Peak elevation of the 10-year storm event (infiltration can be used in analysis)	
45.65 ft	Peak elevation of the 50-year storm event (infiltration can be used in analysis)	
46.50 ft	Elevation of the top of the practice (if a basin, this is the elevation of the berm)	
YES	10 peak elevation ≤ Elevation of the top of the trench? ⁵	← yes
YES	If a basin is proposed, 50-year peak elevation ≤ Elevation of berm?	← yes

- Volume below the lowest invert of the outlet structure and excludes forebay volume
- K_{satDESIGN} includes a factor of safety. See Env-Wq 1504.14 for requirements for determining the infiltr. rate
- 1' separation if treatment not required; 4' for treatment in GPAs & WSIPAs; & 3' in all other areas.
- Clean, washed well graded diameter of 1.5 to 3 inches above the in-situ soil.
- If 50-year peak elevation exceeds top of trench, the overflow must be routed in HydroCAD as secondary discharge.

Designer's Notes:

Only Roof Runoff Being treated, allowable separation of 1' is met

(This page is intentionally blank)

Stage-Area-Storage for Pond PP07: Infiltration Basin #1

Elevation (feet)	Surface (sq-ft)	Storage (cubic-feet)
44.00	126	0
44.05	138	7
44.10	150	14
44.15	163	22
44.20	177	30
44.25	191	39
44.30	206	49
44.35	221	60
44.40	236	71
44.45	253	84
44.50	269	97
44.55	287	110
44.60	304	125
44.65	323	141
44.70	342	158
44.75	361	175
44.80	381	194
44.85	402	213
44.90	423	234
44.95	444	256
45.00	466	278
45.05	489	302
45.10	512	327
45.15	536	353
45.20	560	381
45.25	585	409
45.30	611	439
45.35	636	471
45.40	663	503
45.45	690	537
45.50	717	572
45.55	745	609
45.60	774	647
45.65	803	686
45.70	833	727
45.75	863	769
45.80	894	813
45.85	925	859
45.90	957	906
45.95	989	954
46.00	1,022	1,005
46.05	1,050	1,056
46.10	1,079	1,110
46.15	1,108	1,164
46.20	1,138	1,220
46.25	1,168	1,278
46.30	1,198	1,337
46.35	1,229	1,398
46.40	1,260	1,460
46.45	1,291	1,524
46.50	1,323	1,589

(This page is intentionally blank)



INFILTRATION PRACTICE CRITERIA (Env-Wq 1508.06)

Type/Node Name: **PP08 - Infiltration Basin #2**

Enter the type of infiltration practice (e.g., basin, trench) and the node name in the drainage analysis, if applicable

Yes		Have you reviewed Env-Wq 1508.06(a) to ensure that infiltration is allowed?	
0.34	ac	A = Area draining to the practice	
0.03	ac	A _I = Impervious area draining to the practice	
0.09	decimal	I = percent impervious area draining to the practice, in decimal form	
0.13	unitless	R _v = Runoff coefficient = 0.05 + (0.9 x I)	
0.04	ac-in	WQV = 1" x R _v x A	
162	cf	WQV conversion (ac-in x 43,560 sf/ac x 1ft/12")	
41	cf	25% x WQV (check calc for sediment forebay volume)	
NA		Method of pretreatment? (not required for clean or roof runoff)	
NA	cf	V _{SED} = sediment forebay volume, if used for pretreatment	← ≥ 25%WQV
2,058	cf	V = volume ¹ (attach a stage-storage table)	← ≥ WQV
933	sf	A _{SA} = surface area of the bottom of the pond	
0.30	iph	K _{satDESIGN} = design infiltration rate ²	
6.9	hours	T _{DRAIN} = drain time = V / (A _{SA} * I _{DESIGN})	← ≤ 72-hrs
63.00	feet	E _{BTM} = elevation of the bottom of the basin	
62.00	feet	E _{SHWT} = elevation of SHWT (if none found, enter the lowest elevation of the test pit)	
62.00	feet	E _{ROCK} = elevation of bedrock (if none found, enter the lowest elevation of the test pit)	
1.00	feet	D _{SHWT} = separation from SHWT	← ≥ * ³
1.0	feet	D _{ROCK} = separation from bedrock	← ≥ * ³
NA	ft	D _{amend} = Depth of amended soil, if applicable due high infiltration rate	← ≥ 24"
	ft	D _T = depth of trench, if trench proposed	← 4 - 10 ft
	Yes/No	If a trench or underground system is proposed, observation well provided ⁴	
		If a trench is proposed, material in trench	
	Grass Turf	If a basin is proposed, basin floor material	
Yes	Yes/No	If a basin is proposed, the perimeter should be curvilinear, basin floor shall be flat.	
3.0	:1	If a basin is proposed, pond side slopes	← ≥3:1
64.53	ft	Peak elevation of the 10-year storm event (infiltration can be used in analysis)	
64.65	ft	Peak elevation of the 50-year storm event (infiltration can be used in analysis)	
65.50	ft	Elevation of the top of the practice (if a basin, this is the elevation of the berm)	
YES		10 peak elevation ≤ Elevation of the top of the trench? ⁵	← yes
YES		If a basin is proposed, 50-year peak elevation ≤ Elevation of berm?	← yes

1. Volume below the lowest invert of the outlet structure and excludes forebay volume
2. K_{satDESIGN} includes a factor of safety. See Env-Wq 1504.14 for requirements for determining the infilr. rate
3. 1' separation if treatment not required; 4' for treatment in GPAs & WSIPAs; & 3' in all other areas.
4. Clean, washed well graded diameter of 1.5 to 3 inches above the in-situ soil.
5. If 50-year peak elevation exceeds top of trench, the overflow must be routed in HydroCAD as secondary discharge.

Designer's Notes:

Only Roof Runoff Being treated, allowable separation of 1' separation is met

(This page is intentionally blank)

Stage-Area-Storage for Pond PP08: Infiltration Basin #2

Elevation (feet)	Surface (sq-ft)	Storage (cubic-feet)
63.00	1,074	0
63.05	1,092	54
63.10	1,111	109
63.15	1,130	165
63.20	1,149	222
63.25	1,168	280
63.30	1,187	339
63.35	1,206	399
63.40	1,226	460
63.45	1,245	521
63.50	1,265	584
63.55	1,285	648
63.60	1,305	713
63.65	1,325	778
63.70	1,346	845
63.75	1,366	913
63.80	1,387	982
63.85	1,408	1,052
63.90	1,429	1,123
63.95	1,450	1,195
64.00	1,472	1,268
64.05	1,493	1,342
64.10	1,515	1,417
64.15	1,537	1,493
64.20	1,559	1,571
64.25	1,581	1,649
64.30	1,603	1,729
64.35	1,626	1,809
64.40	1,648	1,891
64.45	1,671	1,974
64.50	1,694	2,058
64.55	1,717	2,144
64.60	1,740	2,230
64.65	1,764	2,318
64.70	1,787	2,407
64.75	1,811	2,497
64.80	1,835	2,588
64.85	1,859	2,680
64.90	1,883	2,774
64.95	1,908	2,868
65.00	1,932	2,964
65.05	1,981	3,062
65.10	2,030	3,162
65.15	2,080	3,265
65.20	2,130	3,370
65.25	2,181	3,478
65.30	2,233	3,589
65.35	2,285	3,702
65.40	2,338	3,817
65.45	2,392	3,935
65.50	2,446	4,056

(This page is intentionally blank)

(This page is intentionally blank)

Stage-Area-Storage for Pond PP07: Infiltration Basin #1

Elevation (feet)	Surface (sq-ft)	Storage (cubic-feet)
44.00	126	0
44.05	138	7
44.10	150	14
44.15	163	22
44.20	177	30
44.25	191	39
44.30	206	49
44.35	221	60
44.40	236	71
44.45	253	84
44.50	269	97
44.55	287	110
44.60	304	125
44.65	323	141
44.70	342	158
44.75	361	175
44.80	381	194
44.85	402	213
44.90	423	234
44.95	444	256
45.00	466	278
45.05	489	302
45.10	512	327
45.15	536	353
45.20	560	381
45.25	585	409
45.30	611	439
45.35	636	471
45.40	663	503
45.45	690	537
45.50	717	572
45.55	745	609
45.60	774	647
45.65	803	686
45.70	833	727
45.75	863	769
45.80	894	813
45.85	925	859
45.90	957	906
45.95	989	954
46.00	1,022	1,005
46.05	1,050	1,056
46.10	1,079	1,110
46.15	1,108	1,164
46.20	1,138	1,220
46.25	1,168	1,278
46.30	1,198	1,337
46.35	1,229	1,398
46.40	1,260	1,460
46.45	1,291	1,524
46.50	1,323	1,589

Stage-Area-Storage for Pond PP08: Infiltration Basin #2

Elevation (feet)	Surface (sq-ft)	Storage (cubic-feet)
63.00	1,074	0
63.05	1,092	54
63.10	1,111	109
63.15	1,130	165
63.20	1,149	222
63.25	1,168	280
63.30	1,187	339
63.35	1,206	399
63.40	1,226	460
63.45	1,245	521
63.50	1,265	584
63.55	1,285	648
63.60	1,305	713
63.65	1,325	778
63.70	1,346	845
63.75	1,366	913
63.80	1,387	982
63.85	1,408	1,052
63.90	1,429	1,123
63.95	1,450	1,195
64.00	1,472	1,268
64.05	1,493	1,342
64.10	1,515	1,417
64.15	1,537	1,493
64.20	1,559	1,571
64.25	1,581	1,649
64.30	1,603	1,729
64.35	1,626	1,809
64.40	1,648	1,891
64.45	1,671	1,974
64.50	1,694	2,058
64.55	1,717	2,144
64.60	1,740	2,230
64.65	1,764	2,318
64.70	1,787	2,407
64.75	1,811	2,497
64.80	1,835	2,588
64.85	1,859	2,680
64.90	1,883	2,774
64.95	1,908	2,868
65.00	1,932	2,964
65.05	1,981	3,062
65.10	2,030	3,162
65.15	2,080	3,265
65.20	2,130	3,370
65.25	2,181	3,478
65.30	2,233	3,589
65.35	2,285	3,702
65.40	2,338	3,817
65.45	2,392	3,935
65.50	2,446	4,056

APPENDIX G **RIPRAP CALCULATIONS**

(This Page Is Intentionally Blank)

RIPRAP OUTLET PROTECTION

Location: **FES #1- (MH01) Outlet of Underdrain for R-Tanks**

Design Flow =	Q =	0.1	cfs
Tailwater =	Tw =	0.666667	feet
Pipe Dia.=	Do =	1	feet

$La = \text{Length} = 3Q/Do^{(3/2)} + 7Do =$ **7** feet

$W_1 = \text{Width} = 3Do + (0.4)(La) =$ **6** feet **(or Width of Channel)**

$W_2 = \text{Width} = 3Do =$ **3** feet

$D = \text{Depth} = (1.5)(1.5d50) =$ **7** inches **(or Min. 6")**

$d50 = (.02)(Q)^{(4/3)} / (Tw * Do) =$ **3.00** inches **(or Min. 3")**

Rock Riprap Gradation

% of weight smaller than the given size.

Size of stone (inches)

100		4.50	-	6.00
85		3.90	-	5.40
50	(See Last Page of Calculations for 25-Year Flows)	3.00	-	4.50
15		0.90	-	1.50

RIPRAP OUTLET PROTECTION

Location: **FES#2 - (P003A) Outlet from Overflow of R-Tanks**

Design Flow =	Q =	0.2	cfs
Tailwater =	Tw =	0.666667	feet
Pipe Dia.=	Do =	1	feet

$La = \text{Length} = 3Q/Do^{(3/2)} + 7Do =$ **8** feet

$W = \text{Width} = 3Do + (0.4)(La) =$ **6** feet **(or Width of Channel)**
 $W_2 = \text{Width} = 3Do =$ **3** feet

$D = \text{Depth} = (1.5)(1.5d50) =$ **7** inches **(or Min. 6")**

$d50 = (.02)(Q)^{(4/3)} / (Tw * Do) =$ **3.00** inches **(or Min. 3")**

Rock Riprap Gradation

% of weight smaller than the given size.

Size of stone (inches)

100		4.50	-	6.00
85		3.90	-	5.40
50		3.00	-	4.50
15	(See Last Page of Calculations for 25-Year Flows)	0.90	-	1.50

RIPRAP OUTLET PROTECTION

Location: **FES#3 - (PP04a)From Bioretention Area #3**

Design Flow =	Q =	2.6	cfs
Tailwater =	Tw =	0.666667	feet
Pipe Dia.=	Do =	1	feet

$La = \text{Length} = 3Q/Do^{(3/2)} + 7Do =$ **15** feet

$W = \text{Width} = 3Do+(0.4)(La)=$ **9** feet **(or Width of Channel)**
 $W_2 = \text{Width} = 3Do=$ **3** feet

$D = \text{Depth} = (1.5)(1.5d50)=$ **7** inches **(or Min. 6")**

$d50 = (.02)(Q)^{(4/3)}/(Tw*Do)=$ **3.00** inches **(or Min. 3")**

Rock Riprap Gradation

% of weight smaller than the given size.

Size of stone (inches)

100		4.50	-	6.00
85		3.90	-	5.40
50		3.00	-	4.50
15	(See Last Page of Calculations for 25-Year Flows)	0.90	-	1.50

RIPRAP OUTLET PROTECTION

Location: **FES#4 - (PP04b)From Bioretention Area #4**

Design Flow =	Q =	1.5	cfs
Tailwater =	Tw =	0.666667	feet
Pipe Dia.=	Do =	1	feet

$La = \text{Length} = 3Q/Do^{(3/2)} + 7Do =$ **12** feet

$W = \text{Width} = 3Do+(0.4)(La)=$ **8** feet **(or Width of Channel)**
 $W_2 = \text{Width} = 3Do=$ **3** feet

$D = \text{Depth} = (1.5)(1.5d50)=$ **7** inches **(or Min. 6")**

$d50 = (.02)(Q)^{(4/3)}/(Tw*Do)=$ **3.00** inches **(or Min. 3")**

Rock Riprap Gradation

% of weight smaller than the given size.

Size of stone (inches)

100		4.50	-	6.00
85		3.90	-	5.40
50		3.00	-	4.50
15		0.90	-	1.50

(See Last Page of Calculations
for 25-Year Flows)

RIPRAP OUTLET PROTECTION

Location: FES#5 - (MH05) From Bioretention Area #1

Design Flow =	Q =	0	cfs
Tailwater =	Tw =	0.666667	feet
Pipe Dia.=	Do =	1	feet

$$La = \text{Length} = 3Q/Do^{(3/2)} + 7Do = 7 \text{ feet}$$

$$W = \text{Width} = 3Do + (0.4)(La) = 6 \text{ feet (or Width of Channel)}$$

$$W_2 = \text{Width} = 3Do = 3 \text{ feet}$$

$$D = \text{Depth} = (1.5)(1.5d50) = 7 \text{ inches (or Min. 6")}$$

$$d50 = (.02)(Q)^{(4/3)} / (Tw * Do) = 3.00 \text{ inches (or Min. 3")}$$

Rock Riprap Gradation

% of weight smaller than the given size.

Size of stone (inches)

100
85
50
15

(See Last Page of Calculations
 for 25-Year Flows)

4.50	-	6.00
3.90	-	5.40
3.00	-	4.50
0.90	-	1.50

RIPRAP OUTLET PROTECTION

Location: FES #6 - (Ci01) Curb Inlet 01

Design Flow =	Q =	0.6	cfs
Tailwater =	Tw =	0.666667	feet
Pipe Dia.=	Do =	1	feet

$$La = \text{Length} = 3Q/Do^{(3/2)} + 7Do = \mathbf{9} \text{ feet}$$

$$W = \text{Width} = 3Do + (0.4)(La) = \mathbf{7} \text{ feet} \quad \text{(or Width of Channel)}$$

$$W_2 = \text{Width} = 3Do = \mathbf{3} \text{ feet}$$

$$D = \text{Depth} = (1.5)(1.5d50) = \mathbf{7} \text{ inches} \quad \text{(or Min. 6")}$$

$$d50 = (.02)(Q)^{(4/3)} / (Tw * Do) = \mathbf{3.00} \text{ inches} \quad \text{(or Min. 3")}$$

Rock Riprap Gradation

% of weight smaller than the given size.

Size of stone (inches)

	100
	85
	50
MSC Civil Engineers Land Surveyors, Inc.	15

(See Last Page of Calculations
 for 25-Year Flows)

4.50	-	6.00
3.90	-	5.40
3.00	-	4.50
0.90	-	1.50

RIPRAP OUTLET PROTECTION

Location: FES #7 - (Ci02) Curb Inlet 02

Design Flow =	Q =	0.6	cfs
Tailwater =	Tw =	0.666667	feet
Pipe Dia.=	Do =	1	feet

$La = \text{Length} = 3Q/Do^{(3/2)} + 7Do = 9 \text{ feet}$

$W = \text{Width} = 3Do + (0.4)(La) = 7 \text{ feet (or Width of Channel)}$
 $W_2 = \text{Width} = 3Do = 3 \text{ feet}$

$D = \text{Depth} = (1.5)(1.5d50) = 7 \text{ inches (or Min. 6")}$

$d50 = (.02)(Q)^{(4/3)} / (Tw * Do) = 3.00 \text{ inches (or Min. 3")}$

Rock Riprap Gradation

% of weight smaller than the given size.

Size of stone (inches)

100
85
50
15

(See Last Page of Calculations
 for 25-Year Flows)

4.50	-	6.00
3.90	-	5.40
3.00	-	4.50
0.90	-	1.50

RIPRAP OUTLET PROTECTION

Location: FES #8 - Outlet to Bioretention Area #2 (CB07)

Design Flow =	Q =	4	cfs
Tailwater =	Tw =	0.666667	feet
Pipe Dia.=	Do =	1	feet

$La = \text{Length} = 3Q/Do^{(3/2)} + 7Do = 19 \text{ feet}$

$W = \text{Width} = 3Do + (0.4)(La) = 11 \text{ feet (or Width of Channel)}$
 $W_2 = \text{Width} = 3Do = 3 \text{ feet}$

$D = \text{Depth} = (1.5)(1.5d50) = 7 \text{ inches (or Min. 6")}$

$d50 = (.02)(Q)^{(4/3)} / (Tw * Do) = 3.00 \text{ inches (or Min. 3")}$

Rock Riprap Gradation

% of weight smaller than the given size.

Size of stone (inches)

100
85
50
15

4.50	-	6.00
3.90	-	5.40
3.00	-	4.50
0.90	-	1.50

RIPRAP OUTLET PROTECTION

Location: FES #9 - Outlet to Bioretention Area #3 (CB08)

Design Flow =	Q =	2.2	cfs
Tailwater =	Tw =	0.666667	feet
Pipe Dia.=	Do =	1	feet

$La = \text{Length} = 3Q/Do^{(3/2)} + 7Do = 14 \text{ feet}$

$W = \text{Width} = 3Do + (0.4)(La) = 8 \text{ feet (or Width of Channel)}$
 $W_2 = \text{Width} = 3Do = 3 \text{ feet}$

$D = \text{Depth} = (1.5)(1.5d50) = 7 \text{ inches (or Min. 6")}$

$d50 = (.02)(Q)^{(4/3)} / (Tw * Do) = 3.00 \text{ inches (or Min. 3")}$

Rock Riprap Gradation

% of weight smaller than the given size.

Size of stone (inches)

100
85
50
15

4.50	-	6.00
3.90	-	5.40
3.00	-	4.50
0.90	-	1.50

RIPRAP OUTLET PROTECTION

Location: FES #10 - Outlet to Bioretention Area #2 (CB05)

Design Flow =	Q =	0.6	cfs
Tailwater =	Tw =	0.333333	feet
Pipe Dia.=	Do =	0.5	feet

$$La = \text{Length} = 3Q/Do^{(3/2)} + 7Do = \mathbf{9} \text{ feet}$$

$$W = \text{Width} = 3Do + (0.4)(La) = \mathbf{5} \text{ feet} \quad (\text{or Width of Channel})$$

$$W_2 = \text{Width} = 3Do = 1.5 \text{ feet}$$

$$D = \text{Depth} = (1.5)(1.5d50) = \mathbf{7} \text{ inches} \quad (\text{or Min. 6"})$$

$$d50 = (.02)(Q)^{(4/3)} / (Tw * Do) = \mathbf{3.00} \text{ inches} \quad (\text{or Min. 3"})$$

Rock Riprap Gradation

% of weight smaller than the given size.

Size of stone (inches)

100	4.50	-	6.00
85	3.90	-	5.40
50	3.00	-	4.50
15	0.90	-	1.50

RIPRAP OUTLET PROTECTION

Location: FES #11 - Outlet to Bioretention Area #3 (CB06)

Design Flow =	Q =	0.6	cfs
Tailwater =	Tw =	0.333333	feet
Pipe Dia.=	Do =	0.5	feet

$La = \text{Length} = 3Q/Do^{(3/2)} + 7Do = 9 \text{ feet}$

$W = \text{Width} = 3Do + (0.4)(La) = 5 \text{ feet (or Width of Channel)}$
 $W_2 = \text{Width} = 3Do = 1.5 \text{ feet}$

$D = \text{Depth} = (1.5)(1.5d50) = 7 \text{ inches (or Min. 6")}$

$d50 = (.02)(Q)^{(4/3)} / (Tw * Do) = 3.00 \text{ inches (or Min. 3")}$

Rock Riprap Gradation

% of weight smaller than the given size.

Size of stone (inches)

100	4.50	-	6.00
85	3.90	-	5.40
50	3.00	-	4.50
15	0.90	-	1.50

(This page is intentionally blank)

477361-00_PRE-&-POST_2020-04-20

Prepared by {enter your company name here}

HydroCAD® 10.10-3a s/n 00866 © 2020 HydroCAD Software Solutions LLC

Post Development -RipRap
Type III 24-hr 25-YR Rainfall=7.16"

Printed 4/28/2020

Page 1

Time span=0.00-24.00 hrs, dt=0.06 hrs, 401 points x 2
Runoff by SCS TR-20 method, UH=SCS, Weighted-CN
Reach routing by Dyn-Stor-Ind method - Pond routing by Dyn-Stor-Ind method

Pond CB05: CB-05	Peak Elev=48.21'	Inflow=0.6 cfs	1,944 cf
6.0" Round Culvert	n=0.013	L=15.0'	S=0.0100 '/ Outflow=0.6 cfs 1,944 cf
Pond CB06: CB-06	Peak Elev=45.75'	Inflow=0.5 cfs	1,630 cf
6.0" Round Culvert	n=0.013	L=15.0'	S=0.0100 '/ Outflow=0.5 cfs 1,630 cf
Pond CB07: CB-07	Peak Elev=51.11'	Inflow=4.0 cfs	16,443 cf
12.0" Round Culvert	n=0.013	L=114.0'	S=0.0175 '/ Outflow=4.0 cfs 16,443 cf
Pond CB08: CB-08	Peak Elev=50.33'	Inflow=2.2 cfs	7,396 cf
12.0" Round Culvert	n=0.013	L=110.0'	S=0.0318 '/ Outflow=2.2 cfs 7,396 cf
Pond Ci01: CURB INLET 1	Peak Elev=26.83'	Inflow=0.6 cfs	1,843 cf
			Outflow=0.6 cfs 1,843 cf
Pond Ci02: CURB INLET 2	Peak Elev=26.82'	Inflow=0.6 cfs	1,799 cf
			Outflow=0.6 cfs 1,799 cf
Pond MH01: MH 1	Peak Elev=28.68'	Inflow=0.1 cfs	6,001 cf
12.0" Round Culvert	n=0.012	L=91.0'	S=0.0082 '/ Outflow=0.1 cfs 6,001 cf
Pond MH05: MH 5	Peak Elev=51.30'	Inflow=0.0 cfs	0 cf
12.0" Round Culvert	n=0.013	L=65.0'	S=0.0523 '/ Outflow=0.0 cfs 0 cf
Pond PP03a: R-Tank #1 and 2	Peak Elev=34.00'	Storage=3,644 cf	Inflow=2.1 cfs 8,332 cf
	Primary=0.1 cfs 2,649 cf	Secondary=0.2 cfs 2,198 cf	Outflow=0.3 cfs 4,847 cf
Pond PP04A: Bioretention Area #2	Peak Elev=48.11'	Storage=4,728 cf	Inflow=4.4 cfs 18,386 cf
	Primary=2.6 cfs 17,463 cf	Secondary=0.9 cfs 672 cf	Outflow=3.6 cfs 18,135 cf
Pond PP04B: Bioretention Area #3	Peak Elev=45.52'	Storage=3,779 cf	Inflow=2.6 cfs 9,026 cf
	Primary=1.5 cfs 5,889 cf	Secondary=0.1 cfs 23 cf	Outflow=1.5 cfs 5,912 cf

(This page is intentionally blank)

APPENDIX H
NRCS WEB SOILS SURVEY

(This Page Is Intentionally Blank)

Custom Soil Resource Report for Rockingham County, New Hampshire

Banfield - Portsmouth, NH



Preface

Soil surveys contain information that affects land use planning in survey areas. They highlight soil limitations that affect various land uses and provide information about the properties of the soils in the survey areas. Soil surveys are designed for many different users, including farmers, ranchers, foresters, agronomists, urban planners, community officials, engineers, developers, builders, and home buyers. Also, conservationists, teachers, students, and specialists in recreation, waste disposal, and pollution control can use the surveys to help them understand, protect, or enhance the environment.

Various land use regulations of Federal, State, and local governments may impose special restrictions on land use or land treatment. Soil surveys identify soil properties that are used in making various land use or land treatment decisions. The information is intended to help the land users identify and reduce the effects of soil limitations on various land uses. The landowner or user is responsible for identifying and complying with existing laws and regulations.

Although soil survey information can be used for general farm, local, and wider area planning, onsite investigation is needed to supplement this information in some cases. Examples include soil quality assessments (<http://www.nrcs.usda.gov/wps/portal/nrcs/main/soils/health/>) and certain conservation and engineering applications. For more detailed information, contact your local USDA Service Center (<https://offices.sc.egov.usda.gov/locator/app?agency=nrcs>) or your NRCS State Soil Scientist (http://www.nrcs.usda.gov/wps/portal/nrcs/detail/soils/contactus/?cid=nrcs142p2_053951).

Great differences in soil properties can occur within short distances. Some soils are seasonally wet or subject to flooding. Some are too unstable to be used as a foundation for buildings or roads. Clayey or wet soils are poorly suited to use as septic tank absorption fields. A high water table makes a soil poorly suited to basements or underground installations.

The National Cooperative Soil Survey is a joint effort of the United States Department of Agriculture and other Federal agencies, State agencies including the Agricultural Experiment Stations, and local agencies. The Natural Resources Conservation Service (NRCS) has leadership for the Federal part of the National Cooperative Soil Survey.

Information about soils is updated periodically. Updated information is available through the NRCS Web Soil Survey, the site for official soil survey information.

The U.S. Department of Agriculture (USDA) prohibits discrimination in all its programs and activities on the basis of race, color, national origin, age, disability, and where applicable, sex, marital status, familial status, parental status, religion, sexual orientation, genetic information, political beliefs, reprisal, or because all or a part of an individual's income is derived from any public assistance program. (Not all prohibited bases apply to all programs.) Persons with disabilities who require

alternative means for communication of program information (Braille, large print, audiotape, etc.) should contact USDA's TARGET Center at (202) 720-2600 (voice and TDD). To file a complaint of discrimination, write to USDA, Director, Office of Civil Rights, 1400 Independence Avenue, S.W., Washington, D.C. 20250-9410 or call (800) 795-3272 (voice) or (202) 720-6382 (TDD). USDA is an equal opportunity provider and employer.

Contents

Preface	2
How Soil Surveys Are Made	5
Soil Map	8
Soil Map.....	9
Legend.....	10
Map Unit Legend.....	11
Map Unit Descriptions.....	11
Rockingham County, New Hampshire.....	13
38B—Eldridge fine sandy loam, 3 to 8 percent slopes.....	13
134—Maybid silt loam.....	14
140B—Chatfield-Hollis-Canton complex, 0 to 8 percent slopes, rocky.....	15
140C—Chatfield-Hollis-Canton complex, 8 to 15 percent slopes, rocky.....	18
538A—Squamscott fine sandy loam, 0 to 5 percent slopes.....	21
References	23

How Soil Surveys Are Made

Soil surveys are made to provide information about the soils and miscellaneous areas in a specific area. They include a description of the soils and miscellaneous areas and their location on the landscape and tables that show soil properties and limitations affecting various uses. Soil scientists observed the steepness, length, and shape of the slopes; the general pattern of drainage; the kinds of crops and native plants; and the kinds of bedrock. They observed and described many soil profiles. A soil profile is the sequence of natural layers, or horizons, in a soil. The profile extends from the surface down into the unconsolidated material in which the soil formed or from the surface down to bedrock. The unconsolidated material is devoid of roots and other living organisms and has not been changed by other biological activity.

Currently, soils are mapped according to the boundaries of major land resource areas (MLRAs). MLRAs are geographically associated land resource units that share common characteristics related to physiography, geology, climate, water resources, soils, biological resources, and land uses (USDA, 2006). Soil survey areas typically consist of parts of one or more MLRA.

The soils and miscellaneous areas in a survey area occur in an orderly pattern that is related to the geology, landforms, relief, climate, and natural vegetation of the area. Each kind of soil and miscellaneous area is associated with a particular kind of landform or with a segment of the landform. By observing the soils and miscellaneous areas in the survey area and relating their position to specific segments of the landform, a soil scientist develops a concept, or model, of how they were formed. Thus, during mapping, this model enables the soil scientist to predict with a considerable degree of accuracy the kind of soil or miscellaneous area at a specific location on the landscape.

Commonly, individual soils on the landscape merge into one another as their characteristics gradually change. To construct an accurate soil map, however, soil scientists must determine the boundaries between the soils. They can observe only a limited number of soil profiles. Nevertheless, these observations, supplemented by an understanding of the soil-vegetation-landscape relationship, are sufficient to verify predictions of the kinds of soil in an area and to determine the boundaries.

Soil scientists recorded the characteristics of the soil profiles that they studied. They noted soil color, texture, size and shape of soil aggregates, kind and amount of rock fragments, distribution of plant roots, reaction, and other features that enable them to identify soils. After describing the soils in the survey area and determining their properties, the soil scientists assigned the soils to taxonomic classes (units). Taxonomic classes are concepts. Each taxonomic class has a set of soil characteristics with precisely defined limits. The classes are used as a basis for comparison to classify soils systematically. Soil taxonomy, the system of taxonomic classification used in the United States, is based mainly on the kind and character of soil properties and the arrangement of horizons within the profile. After the soil

scientists classified and named the soils in the survey area, they compared the individual soils with similar soils in the same taxonomic class in other areas so that they could confirm data and assemble additional data based on experience and research.

The objective of soil mapping is not to delineate pure map unit components; the objective is to separate the landscape into landforms or landform segments that have similar use and management requirements. Each map unit is defined by a unique combination of soil components and/or miscellaneous areas in predictable proportions. Some components may be highly contrasting to the other components of the map unit. The presence of minor components in a map unit in no way diminishes the usefulness or accuracy of the data. The delineation of such landforms and landform segments on the map provides sufficient information for the development of resource plans. If intensive use of small areas is planned, onsite investigation is needed to define and locate the soils and miscellaneous areas.

Soil scientists make many field observations in the process of producing a soil map. The frequency of observation is dependent upon several factors, including scale of mapping, intensity of mapping, design of map units, complexity of the landscape, and experience of the soil scientist. Observations are made to test and refine the soil-landscape model and predictions and to verify the classification of the soils at specific locations. Once the soil-landscape model is refined, a significantly smaller number of measurements of individual soil properties are made and recorded. These measurements may include field measurements, such as those for color, depth to bedrock, and texture, and laboratory measurements, such as those for content of sand, silt, clay, salt, and other components. Properties of each soil typically vary from one point to another across the landscape.

Observations for map unit components are aggregated to develop ranges of characteristics for the components. The aggregated values are presented. Direct measurements do not exist for every property presented for every map unit component. Values for some properties are estimated from combinations of other properties.

While a soil survey is in progress, samples of some of the soils in the area generally are collected for laboratory analyses and for engineering tests. Soil scientists interpret the data from these analyses and tests as well as the field-observed characteristics and the soil properties to determine the expected behavior of the soils under different uses. Interpretations for all of the soils are field tested through observation of the soils in different uses and under different levels of management. Some interpretations are modified to fit local conditions, and some new interpretations are developed to meet local needs. Data are assembled from other sources, such as research information, production records, and field experience of specialists. For example, data on crop yields under defined levels of management are assembled from farm records and from field or plot experiments on the same kinds of soil.

Predictions about soil behavior are based not only on soil properties but also on such variables as climate and biological activity. Soil conditions are predictable over long periods of time, but they are not predictable from year to year. For example, soil scientists can predict with a fairly high degree of accuracy that a given soil will have a high water table within certain depths in most years, but they cannot predict that a high water table will always be at a specific level in the soil on a specific date.

After soil scientists located and identified the significant natural bodies of soil in the survey area, they drew the boundaries of these bodies on aerial photographs and

Custom Soil Resource Report

identified each as a specific map unit. Aerial photographs show trees, buildings, fields, roads, and rivers, all of which help in locating boundaries accurately.

Soil Map

The soil map section includes the soil map for the defined area of interest, a list of soil map units on the map and extent of each map unit, and cartographic symbols displayed on the map. Also presented are various metadata about data used to produce the map, and a description of each soil map unit.

Custom Soil Resource Report Soil Map

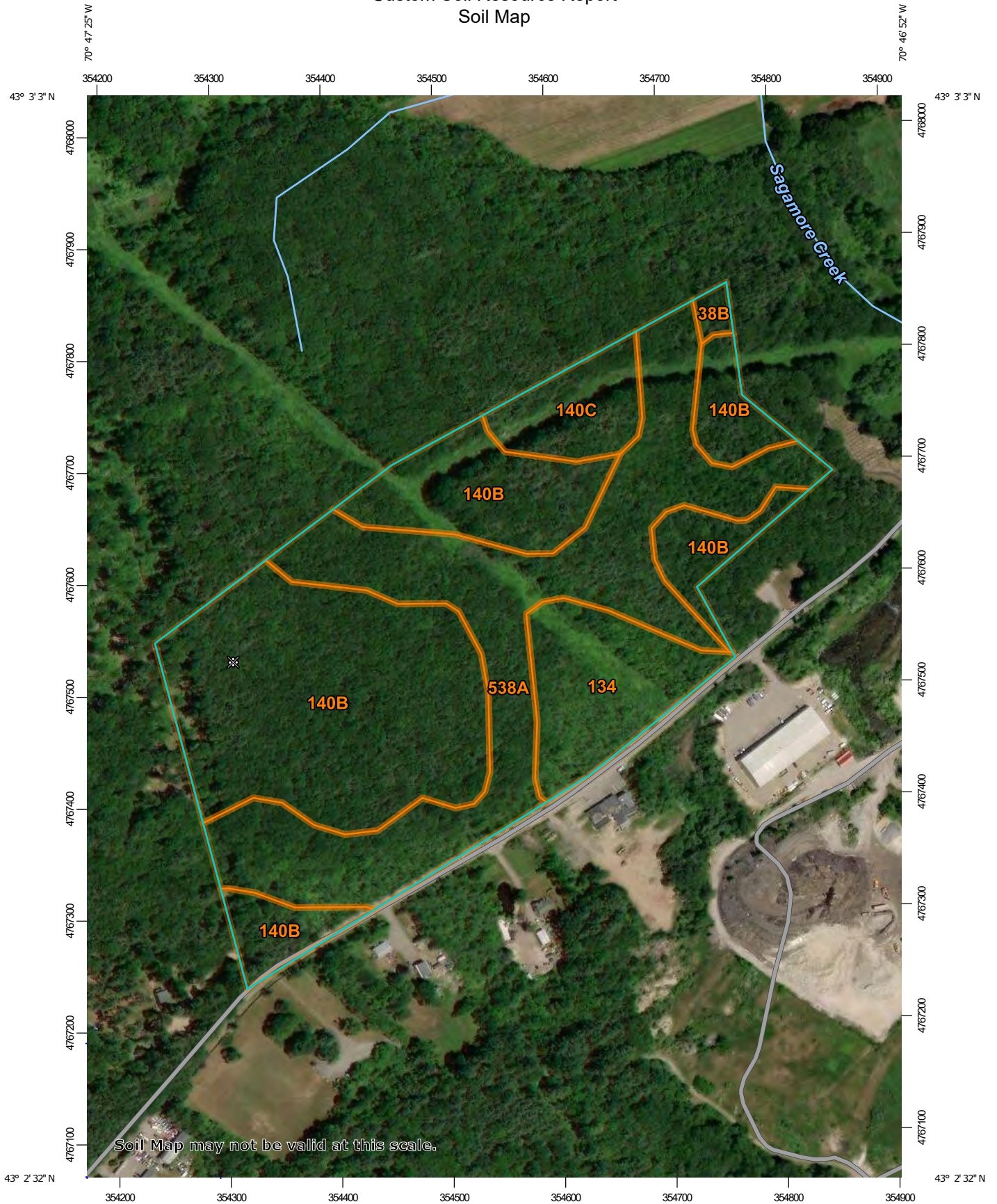

Soil Map may not be valid at this scale.

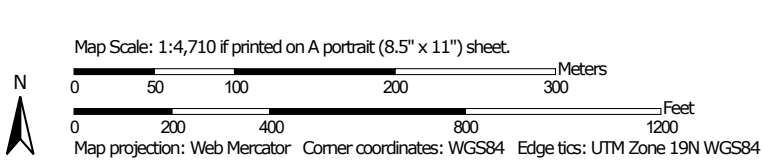

MAP LEGEND

Area of Interest (AOI)

 Area of Interest (AOI)



















Soils

 Soil Map Unit Polygons

 Soil Map Unit Lines

 Soil Map Unit Points

Special Point Features





-  Blowout
-  Borrow Pit
-  Clay Spot
-  Closed Depression
-  Gravel Pit
-  Gravelly Spot
-  Landfill
-  Lava Flow
-  Marsh or swamp
-  Mine or Quarry
-  Miscellaneous Water
-  Perennial Water
-  Rock Outcrop
-  Saline Spot
-  Sandy Spot
-  Severely Eroded Spot
-  Sinkhole
-  Slide or Slip
-  Sodic Spot

-  Spoil Area
-  Stony Spot
-  Very Stony Spot
-  Wet Spot
-  Other
-  Special Line Features

Water Features

 Streams and Canals

Transportation

-  Rails
-  Interstate Highways
-  US Routes
-  Major Roads
-  Local Roads

Background

 Aerial Photography

MAP INFORMATION

The soil surveys that comprise your AOI were mapped at 1:24,000.

Warning: Soil Map may not be valid at this scale.

Enlargement of maps beyond the scale of mapping can cause misunderstanding of the detail of mapping and accuracy of soil line placement. The maps do not show the small areas of contrasting soils that could have been shown at a more detailed scale.

Please rely on the bar scale on each map sheet for map measurements.

Source of Map: Natural Resources Conservation Service
 Web Soil Survey URL:
 Coordinate System: Web Mercator (EPSG:3857)

Maps from the Web Soil Survey are based on the Web Mercator projection, which preserves direction and shape but distorts distance and area. A projection that preserves area, such as the Albers equal-area conic projection, should be used if more accurate calculations of distance or area are required.

This product is generated from the USDA-NRCS certified data as of the version date(s) listed below.

Soil Survey Area: Rockingham County, New Hampshire
 Survey Area Data: Version 20, Sep 7, 2018

Soil map units are labeled (as space allows) for map scales 1:50,000 or larger.

Date(s) aerial images were photographed: Dec 31, 2009—Jun 14, 2017

The orthophoto or other base map on which the soil lines were compiled and digitized probably differs from the background imagery displayed on these maps. As a result, some minor shifting of map unit boundaries may be evident.

Map Unit Legend

Map Unit Symbol	Map Unit Name	Acres in AOI	Percent of AOI
38B	Eldridge fine sandy loam, 3 to 8 percent slopes	0.3	0.7%
134	Maybid silt loam	4.5	10.0%
140B	Chatfield-Hollis-Canton complex, 0 to 8 percent slopes, rocky	22.1	48.5%
140C	Chatfield-Hollis-Canton complex, 8 to 15 percent slopes, rocky	2.5	5.5%
538A	Squamscott fine sandy loam, 0 to 5 percent slopes	16.1	35.4%
Totals for Area of Interest		45.5	100.0%

Map Unit Descriptions

The map units delineated on the detailed soil maps in a soil survey represent the soils or miscellaneous areas in the survey area. The map unit descriptions, along with the maps, can be used to determine the composition and properties of a unit.

A map unit delineation on a soil map represents an area dominated by one or more major kinds of soil or miscellaneous areas. A map unit is identified and named according to the taxonomic classification of the dominant soils. Within a taxonomic class there are precisely defined limits for the properties of the soils. On the landscape, however, the soils are natural phenomena, and they have the characteristic variability of all natural phenomena. Thus, the range of some observed properties may extend beyond the limits defined for a taxonomic class. Areas of soils of a single taxonomic class rarely, if ever, can be mapped without including areas of other taxonomic classes. Consequently, every map unit is made up of the soils or miscellaneous areas for which it is named and some minor components that belong to taxonomic classes other than those of the major soils.

Most minor soils have properties similar to those of the dominant soil or soils in the map unit, and thus they do not affect use and management. These are called noncontrasting, or similar, components. They may or may not be mentioned in a particular map unit description. Other minor components, however, have properties and behavioral characteristics divergent enough to affect use or to require different management. These are called contrasting, or dissimilar, components. They generally are in small areas and could not be mapped separately because of the scale used. Some small areas of strongly contrasting soils or miscellaneous areas are identified by a special symbol on the maps. If included in the database for a given area, the contrasting minor components are identified in the map unit descriptions along with some characteristics of each. A few areas of minor components may not have been observed, and consequently they are not mentioned in the descriptions, especially where the pattern was so complex that it

Custom Soil Resource Report

was impractical to make enough observations to identify all the soils and miscellaneous areas on the landscape.

The presence of minor components in a map unit in no way diminishes the usefulness or accuracy of the data. The objective of mapping is not to delineate pure taxonomic classes but rather to separate the landscape into landforms or landform segments that have similar use and management requirements. The delineation of such segments on the map provides sufficient information for the development of resource plans. If intensive use of small areas is planned, however, onsite investigation is needed to define and locate the soils and miscellaneous areas.

An identifying symbol precedes the map unit name in the map unit descriptions. Each description includes general facts about the unit and gives important soil properties and qualities.

Soils that have profiles that are almost alike make up a *soil series*. Except for differences in texture of the surface layer, all the soils of a series have major horizons that are similar in composition, thickness, and arrangement.

Soils of one series can differ in texture of the surface layer, slope, stoniness, salinity, degree of erosion, and other characteristics that affect their use. On the basis of such differences, a soil series is divided into *soil phases*. Most of the areas shown on the detailed soil maps are phases of soil series. The name of a soil phase commonly indicates a feature that affects use or management. For example, Alpha silt loam, 0 to 2 percent slopes, is a phase of the Alpha series.

Some map units are made up of two or more major soils or miscellaneous areas. These map units are complexes, associations, or undifferentiated groups.

A *complex* consists of two or more soils or miscellaneous areas in such an intricate pattern or in such small areas that they cannot be shown separately on the maps. The pattern and proportion of the soils or miscellaneous areas are somewhat similar in all areas. Alpha-Beta complex, 0 to 6 percent slopes, is an example.

An *association* is made up of two or more geographically associated soils or miscellaneous areas that are shown as one unit on the maps. Because of present or anticipated uses of the map units in the survey area, it was not considered practical or necessary to map the soils or miscellaneous areas separately. The pattern and relative proportion of the soils or miscellaneous areas are somewhat similar. Alpha-Beta association, 0 to 2 percent slopes, is an example.

An *undifferentiated group* is made up of two or more soils or miscellaneous areas that could be mapped individually but are mapped as one unit because similar interpretations can be made for use and management. The pattern and proportion of the soils or miscellaneous areas in a mapped area are not uniform. An area can be made up of only one of the major soils or miscellaneous areas, or it can be made up of all of them. Alpha and Beta soils, 0 to 2 percent slopes, is an example.

Some surveys include *miscellaneous areas*. Such areas have little or no soil material and support little or no vegetation. Rock outcrop is an example.

Rockingham County, New Hampshire

38B—Eldridge fine sandy loam, 3 to 8 percent slopes

Map Unit Setting

National map unit symbol: 9cnb
Elevation: 90 to 1,000 feet
Mean annual precipitation: 30 to 55 inches
Mean annual air temperature: 45 to 54 degrees F
Frost-free period: 120 to 180 days
Farmland classification: All areas are prime farmland

Map Unit Composition

Eldridge and similar soils: 80 percent
Minor components: 20 percent
Estimates are based on observations, descriptions, and transects of the mapunit.

Description of Eldridge

Setting

Parent material: Outwash over glaciolacustrine

Typical profile

H1 - 0 to 8 inches: fine sandy loam
H2 - 8 to 23 inches: loamy fine sand
H3 - 23 to 62 inches: loamy very fine sand

Properties and qualities

Slope: 3 to 8 percent
Depth to restrictive feature: More than 80 inches
Natural drainage class: Moderately well drained
Runoff class: Medium
Capacity of the most limiting layer to transmit water (Ksat): Moderately low to moderately high (0.06 to 0.60 in/hr)
Depth to water table: About 12 to 24 inches
Frequency of flooding: None
Frequency of ponding: None
Available water storage in profile: High (about 9.9 inches)

Interpretive groups

Land capability classification (irrigated): None specified
Land capability classification (nonirrigated): 2w
Hydrologic Soil Group: C/D
Hydric soil rating: No

Minor Components

Squamscott

Percent of map unit: 5 percent
Landform: Marine terraces
Hydric soil rating: Yes

Boxford

Percent of map unit: 5 percent
Hydric soil rating: No

Well drained inclusion

Percent of map unit: 5 percent
Hydric soil rating: No

Scitico

Percent of map unit: 5 percent
Landform: Marine terraces
Hydric soil rating: Yes

134—Maybid silt loam

Map Unit Composition

Maybid and similar soils: 75 percent
Minor components: 25 percent
Estimates are based on observations, descriptions, and transects of the mapunit.

Description of Maybid

Setting

Landform: Marine terraces
Parent material: Silty and clayey marine deposits

Typical profile

H1 - 0 to 9 inches: silt loam
H2 - 9 to 26 inches: silty clay loam
H3 - 26 to 63 inches: silty clay

Properties and qualities

Slope: 0 to 2 percent
Depth to restrictive feature: More than 80 inches
Natural drainage class: Very poorly drained
Runoff class: High
Capacity of the most limiting layer to transmit water (Ksat): Very low to moderately high (0.00 to 0.20 in/hr)
Depth to water table: About 0 to 6 inches
Frequency of flooding: None
Frequency of ponding: Frequent
Available water storage in profile: Moderate (about 8.8 inches)

Interpretive groups

Land capability classification (irrigated): None specified
Land capability classification (nonirrigated): 6w
Hydrologic Soil Group: C/D
Hydric soil rating: Yes

Minor Components

Ossipee

Percent of map unit: 10 percent
Landform: Swamps
Hydric soil rating: Yes

Scitico

Percent of map unit: 10 percent
Landform: Marine terraces
Hydric soil rating: Yes

Not named wet

Percent of map unit: 5 percent
Landform: Marine terraces
Hydric soil rating: Yes

140B—Chatfield-Hollis-Canton complex, 0 to 8 percent slopes, rocky

Map Unit Setting

National map unit symbol: 2w82m
Elevation: 380 to 1,070 feet
Mean annual precipitation: 36 to 71 inches
Mean annual air temperature: 39 to 55 degrees F
Frost-free period: 145 to 240 days
Farmland classification: Not prime farmland

Map Unit Composition

Chatfield, very stony, and similar soils: 35 percent
Hollis, very stony, and similar soils: 25 percent
Canton, very stony, and similar soils: 25 percent
Minor components: 15 percent
Estimates are based on observations, descriptions, and transects of the mapunit.

Description of Chatfield, Very Stony

Setting

Landform: Ridges, hills
Landform position (two-dimensional): Backslope, shoulder, summit
Landform position (three-dimensional): Crest, side slope, nose slope
Down-slope shape: Convex
Across-slope shape: Linear, convex
Parent material: Coarse-loamy melt-out till derived from granite, gneiss, and/or schist

Typical profile

O_i - 0 to 1 inches: slightly decomposed plant material
A - 1 to 2 inches: fine sandy loam
B_w - 2 to 30 inches: gravelly fine sandy loam
2R - 30 to 40 inches: bedrock

Properties and qualities

Slope: 0 to 8 percent
Percent of area covered with surface fragments: 1.6 percent
Depth to restrictive feature: 20 to 41 inches to lithic bedrock
Natural drainage class: Well drained
Runoff class: High
Capacity of the most limiting layer to transmit water (K_{sat}): Very low (0.00 to 0.00 in/hr)

Custom Soil Resource Report

Depth to water table: More than 80 inches
Frequency of flooding: None
Frequency of ponding: None
Salinity, maximum in profile: Nonsaline (0.0 to 1.9 mmhos/cm)
Available water storage in profile: Low (about 4.3 inches)

Interpretive groups

Land capability classification (irrigated): None specified
Land capability classification (nonirrigated): 6s
Hydrologic Soil Group: B
Hydric soil rating: No

Description of Canton, Very Stony

Setting

Landform: Hills, moraines, ridges
Landform position (two-dimensional): Summit, shoulder, backslope
Landform position (three-dimensional): Side slope, crest, nose slope
Down-slope shape: Linear, convex
Across-slope shape: Convex
Parent material: Coarse-loamy over sandy melt-out till derived from gneiss, granite, and/or schist

Typical profile

O_i - 0 to 2 inches: slightly decomposed plant material
A - 2 to 5 inches: fine sandy loam
Bw₁ - 5 to 16 inches: fine sandy loam
Bw₂ - 16 to 22 inches: gravelly fine sandy loam
2C - 22 to 67 inches: gravelly loamy sand

Properties and qualities

Slope: 0 to 8 percent
Percent of area covered with surface fragments: 1.6 percent
Depth to restrictive feature: 19 to 39 inches to strongly contrasting textural stratification
Natural drainage class: Well drained
Runoff class: Low
Capacity of the most limiting layer to transmit water (K_{sat}): Moderately low to high (0.14 to 14.17 in/hr)
Depth to water table: More than 80 inches
Frequency of flooding: None
Frequency of ponding: None
Salinity, maximum in profile: Nonsaline (0.0 to 1.9 mmhos/cm)
Available water storage in profile: Low (about 3.4 inches)

Interpretive groups

Land capability classification (irrigated): None specified
Land capability classification (nonirrigated): 6s
Hydrologic Soil Group: B
Hydric soil rating: No

Description of Hollis, Very Stony

Setting

Landform: Hills, ridges
Landform position (two-dimensional): Backslope, shoulder, summit
Landform position (three-dimensional): Crest, side slope, nose slope

Custom Soil Resource Report

Down-slope shape: Convex

Across-slope shape: Linear, convex

Parent material: Coarse-loamy melt-out till derived from granite, gneiss, and/or schist

Typical profile

O_i - 0 to 2 inches: slightly decomposed plant material

A - 2 to 7 inches: gravelly fine sandy loam

B_w - 7 to 16 inches: gravelly fine sandy loam

2R - 16 to 26 inches: bedrock

Properties and qualities

Slope: 0 to 8 percent

Percent of area covered with surface fragments: 1.6 percent

Depth to restrictive feature: 8 to 23 inches to lithic bedrock

Natural drainage class: Somewhat excessively drained

Runoff class: Very high

Capacity of the most limiting layer to transmit water (K_{sat}): Very low (0.00 to 0.00 in/hr)

Depth to water table: More than 80 inches

Frequency of flooding: None

Frequency of ponding: None

Salinity, maximum in profile: Nonsaline (0.0 to 1.9 mmhos/cm)

Available water storage in profile: Very low (about 2.7 inches)

Interpretive groups

Land capability classification (irrigated): None specified

Land capability classification (nonirrigated): 6s

Hydrologic Soil Group: D

Hydric soil rating: No

Minor Components

Newfields, very stony

Percent of map unit: 5 percent

Landform: Moraines, hills, ground moraines

Landform position (two-dimensional): Footslope

Landform position (three-dimensional): Base slope

Down-slope shape: Linear

Across-slope shape: Concave

Hydric soil rating: No

Freetown

Percent of map unit: 5 percent

Landform: Depressions, marshes, swamps, kettles, bogs

Down-slope shape: Concave

Across-slope shape: Concave

Hydric soil rating: Yes

Walpole, very stony

Percent of map unit: 3 percent

Landform: Depressions, outwash plains, depressions, deltas, outwash terraces

Landform position (three-dimensional): Tread

Down-slope shape: Concave

Across-slope shape: Concave

Hydric soil rating: Yes

Rock outcrop

Percent of map unit: 2 percent
Landform: Hills, ridges
Hydric soil rating: Unranked

140C—Chatfield-Hollis-Canton complex, 8 to 15 percent slopes, rocky

Map Unit Setting

National map unit symbol: 2w82s
Elevation: 0 to 980 feet
Mean annual precipitation: 36 to 71 inches
Mean annual air temperature: 39 to 55 degrees F
Frost-free period: 145 to 240 days
Farmland classification: Not prime farmland

Map Unit Composition

Chatfield, very stony, and similar soils: 35 percent
Canton, very stony, and similar soils: 25 percent
Hollis, very stony, and similar soils: 25 percent
Minor components: 15 percent
Estimates are based on observations, descriptions, and transects of the mapunit.

Description of Chatfield, Very Stony

Setting

Landform: Ridges, hills
Landform position (two-dimensional): Backslope, shoulder, summit
Landform position (three-dimensional): Crest, side slope, nose slope
Down-slope shape: Convex
Across-slope shape: Linear, convex
Parent material: Coarse-loamy melt-out till derived from granite, gneiss, and/or schist

Typical profile

O_i - 0 to 1 inches: slightly decomposed plant material
A - 1 to 2 inches: fine sandy loam
B_w - 2 to 30 inches: gravelly fine sandy loam
2R - 30 to 40 inches: bedrock

Properties and qualities

Slope: 8 to 15 percent
Percent of area covered with surface fragments: 1.6 percent
Depth to restrictive feature: 20 to 41 inches to lithic bedrock
Natural drainage class: Well drained
Runoff class: High
Capacity of the most limiting layer to transmit water (Ksat): Very low (0.00 to 0.00 in/hr)

Custom Soil Resource Report

Depth to water table: More than 80 inches
Frequency of flooding: None
Frequency of ponding: None
Salinity, maximum in profile: Nonsaline (0.0 to 1.9 mmhos/cm)
Available water storage in profile: Low (about 4.3 inches)

Interpretive groups

Land capability classification (irrigated): None specified
Land capability classification (nonirrigated): 6s
Hydrologic Soil Group: B
Hydric soil rating: No

Description of Hollis, Very Stony

Setting

Landform: Hills, ridges
Landform position (two-dimensional): Backslope, shoulder, summit
Landform position (three-dimensional): Crest, side slope, nose slope
Down-slope shape: Convex
Across-slope shape: Linear, convex
Parent material: Coarse-loamy melt-out till derived from granite, gneiss, and/or schist

Typical profile

O_i - 0 to 2 inches: slightly decomposed plant material
A - 2 to 7 inches: gravelly fine sandy loam
B_w - 7 to 16 inches: gravelly fine sandy loam
2R - 16 to 26 inches: bedrock

Properties and qualities

Slope: 8 to 15 percent
Percent of area covered with surface fragments: 1.6 percent
Depth to restrictive feature: 8 to 23 inches to lithic bedrock
Natural drainage class: Somewhat excessively drained
Runoff class: Very high
Capacity of the most limiting layer to transmit water (K_{sat}): Very low (0.00 to 0.00 in/hr)
Depth to water table: More than 80 inches
Frequency of flooding: None
Frequency of ponding: None
Salinity, maximum in profile: Nonsaline (0.0 to 1.9 mmhos/cm)
Available water storage in profile: Very low (about 2.7 inches)

Interpretive groups

Land capability classification (irrigated): None specified
Land capability classification (nonirrigated): 6s
Hydrologic Soil Group: D
Hydric soil rating: No

Description of Canton, Very Stony

Setting

Landform: Hills, moraines, ridges
Landform position (two-dimensional): Backslope, summit, shoulder
Landform position (three-dimensional): Side slope, crest, nose slope
Down-slope shape: Linear, convex
Across-slope shape: Convex

Custom Soil Resource Report

Parent material: Coarse-loamy over sandy melt-out till derived from gneiss, granite, and/or schist

Typical profile

Oi - 0 to 2 inches: slightly decomposed plant material
A - 2 to 5 inches: fine sandy loam
Bw1 - 5 to 16 inches: fine sandy loam
Bw2 - 16 to 22 inches: gravelly fine sandy loam
2C - 22 to 67 inches: gravelly loamy sand

Properties and qualities

Slope: 8 to 15 percent
Percent of area covered with surface fragments: 1.6 percent
Depth to restrictive feature: 19 to 39 inches to strongly contrasting textural stratification
Natural drainage class: Well drained
Runoff class: Low
Capacity of the most limiting layer to transmit water (Ksat): Moderately low to high (0.14 to 14.17 in/hr)
Depth to water table: More than 80 inches
Frequency of flooding: None
Frequency of ponding: None
Salinity, maximum in profile: Nonsaline (0.0 to 1.9 mmhos/cm)
Available water storage in profile: Low (about 3.4 inches)

Interpretive groups

Land capability classification (irrigated): None specified
Land capability classification (nonirrigated): 6s
Hydrologic Soil Group: B
Hydric soil rating: No

Minor Components

Freetown

Percent of map unit: 5 percent
Landform: Marshes, swamps, kettles, bogs, depressions
Down-slope shape: Concave
Across-slope shape: Concave
Hydric soil rating: Yes

Newfields, very stony

Percent of map unit: 5 percent
Landform: Ground moraines, moraines, hills
Landform position (two-dimensional): Footslope
Landform position (three-dimensional): Base slope
Down-slope shape: Linear
Across-slope shape: Concave
Hydric soil rating: No

Scarboro, very stony

Percent of map unit: 3 percent
Landform: Outwash deltas, drainageways, outwash terraces, depressions
Landform position (three-dimensional): Tread
Down-slope shape: Concave
Across-slope shape: Concave, linear
Hydric soil rating: Yes

Rock outcrop

Percent of map unit: 2 percent
Landform: Hills, ridges
Hydric soil rating: Unranked

538A—Squamscott fine sandy loam, 0 to 5 percent slopes

Map Unit Setting

National map unit symbol: 9cp9
Elevation: 90 to 1,000 feet
Mean annual precipitation: 30 to 55 inches
Mean annual air temperature: 45 to 54 degrees F
Frost-free period: 120 to 180 days
Farmland classification: Farmland of local importance

Map Unit Composition

Squamscott and similar soils: 85 percent
Minor components: 15 percent
Estimates are based on observations, descriptions, and transects of the mapunit.

Description of Squamscott

Setting

Landform: Marine terraces

Typical profile

H1 - 0 to 4 inches: fine sandy loam
H2 - 4 to 12 inches: loamy sand
H3 - 12 to 19 inches: fine sand
H4 - 19 to 65 inches: silt loam

Properties and qualities

Slope: 0 to 5 percent
Depth to restrictive feature: More than 80 inches
Natural drainage class: Poorly drained
Runoff class: Medium
Capacity of the most limiting layer to transmit water (Ksat): Moderately low to moderately high (0.06 to 0.60 in/hr)
Depth to water table: About 0 to 12 inches
Frequency of flooding: None
Frequency of ponding: None
Available water storage in profile: High (about 9.6 inches)

Interpretive groups

Land capability classification (irrigated): None specified
Land capability classification (nonirrigated): 4w
Hydrologic Soil Group: C/D
Hydric soil rating: Yes

Minor Components

Maybid

Percent of map unit: 5 percent

Landform: Marine terraces

Hydric soil rating: Yes

Scitico

Percent of map unit: 5 percent

Landform: Marine terraces

Hydric soil rating: Yes

Eldridge

Percent of map unit: 5 percent

Hydric soil rating: No

References

- American Association of State Highway and Transportation Officials (AASHTO). 2004. Standard specifications for transportation materials and methods of sampling and testing. 24th edition.
- American Society for Testing and Materials (ASTM). 2005. Standard classification of soils for engineering purposes. ASTM Standard D2487-00.
- Cowardin, L.M., V. Carter, F.C. Golet, and E.T. LaRoe. 1979. Classification of wetlands and deep-water habitats of the United States. U.S. Fish and Wildlife Service FWS/OBS-79/31.
- Federal Register. July 13, 1994. Changes in hydric soils of the United States.
- Federal Register. September 18, 2002. Hydric soils of the United States.
- Hurt, G.W., and L.M. Vasilas, editors. Version 6.0, 2006. Field indicators of hydric soils in the United States.
- National Research Council. 1995. Wetlands: Characteristics and boundaries.
- Soil Survey Division Staff. 1993. Soil survey manual. Soil Conservation Service. U.S. Department of Agriculture Handbook 18. http://www.nrcs.usda.gov/wps/portal/nrcs/detail/national/soils/?cid=nrcs142p2_054262
- Soil Survey Staff. 1999. Soil taxonomy: A basic system of soil classification for making and interpreting soil surveys. 2nd edition. Natural Resources Conservation Service, U.S. Department of Agriculture Handbook 436. http://www.nrcs.usda.gov/wps/portal/nrcs/detail/national/soils/?cid=nrcs142p2_053577
- Soil Survey Staff. 2010. Keys to soil taxonomy. 11th edition. U.S. Department of Agriculture, Natural Resources Conservation Service. http://www.nrcs.usda.gov/wps/portal/nrcs/detail/national/soils/?cid=nrcs142p2_053580
- Tiner, R.W., Jr. 1985. Wetlands of Delaware. U.S. Fish and Wildlife Service and Delaware Department of Natural Resources and Environmental Control, Wetlands Section.
- United States Army Corps of Engineers, Environmental Laboratory. 1987. Corps of Engineers wetlands delineation manual. Waterways Experiment Station Technical Report Y-87-1.
- United States Department of Agriculture, Natural Resources Conservation Service. National forestry manual. http://www.nrcs.usda.gov/wps/portal/nrcs/detail/soils/home/?cid=nrcs142p2_053374
- United States Department of Agriculture, Natural Resources Conservation Service. National range and pasture handbook. <http://www.nrcs.usda.gov/wps/portal/nrcs/detail/national/landuse/rangepasture/?cid=stelprdb1043084>

Custom Soil Resource Report

United States Department of Agriculture, Natural Resources Conservation Service. National soil survey handbook, title 430-VI. http://www.nrcs.usda.gov/wps/portal/nrcs/detail/soils/scientists/?cid=nrcs142p2_054242

United States Department of Agriculture, Natural Resources Conservation Service. 2006. Land resource regions and major land resource areas of the United States, the Caribbean, and the Pacific Basin. U.S. Department of Agriculture Handbook 296. http://www.nrcs.usda.gov/wps/portal/nrcs/detail/national/soils/?cid=nrcs142p2_053624

United States Department of Agriculture, Soil Conservation Service. 1961. Land capability classification. U.S. Department of Agriculture Handbook 210. http://www.nrcs.usda.gov/Internet/FSE_DOCUMENTS/nrcs142p2_052290.pdf

APPENDIX I
SITE SPECIFIC SOILS SURVEY

(This Page Is Intentionally Blank)

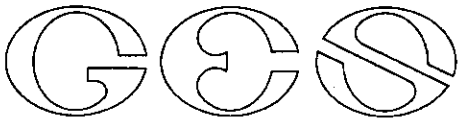

SITE-SPECIFIC SOIL SURVEY REPORT
THE VILLAGES AT BANFIELD ROAD
PORTSMOUTH, NH
GES # 2017071

1. MAPPING STANDARDS

Site-Specific Soil Mapping Standards for New Hampshire and Vermont. SSSNNE Special Publication No. 3, Version 5.0, December 2017. This map product is within the technical standards of the National Cooperative Soil Survey. It is a special product, intended for the submission to NH DES Alteration of Terrain. It was produced by a professional soil scientist and is not a product of the USDA Natural Resource Conservation Service.

2. DATE SOIL MAP PRODUCED

December 19, 2019

3. GEOGRAPHIC LOCATION AND SIZE OF SITE

Approximately 23 acres of the 44.8 acre lot was soil mapped. Tax map 256, Lot 2. The site is located in the City of Portsmouth, NH.

4. PURPOSE OF THE SOIL MAP

The preparation of this map was requested by TFM. The purpose was to meet the requirements of NH Alteration of Terrain.

5. SOIL IDENTIFICATION LEGEND

SSSS SYM.	SSSS MAP NAME	HYDROLOGIC SOIL GRP.
41	Chatfield-Hollis-Rock Outcrop Complex	B
135	Chatfield Variant-Newfields Complex	C
538	Squamscott fine sandy loam	C
656	Ridgebury fine sandy loam	C

SLOPE PHASE:

0-8%	B	8-15%	C	15-25%	D
25%+	E				

8 Continental Dr Bldg 2 Unit H, Exeter, NH 03833-7526
Ph (603) 778 0644 / Fax (603) 778 0654
info@gesinc.biz
www.gesinc.biz

6. SOIL MAP UNIT DESCRIPTIONS

41 – Chatfield-Hollis-Rock Outcrop Complex is located in bedrock-controlled landscapes. A soil complex is a mix of soil types that are too interwoven to be able to separate at the scale of the soil map. Chatfield is the largest component of the complex at 50%. Hollis is the next component at 30%. The last component is Rock Outcrop at 20%. Chatfield is a loamy glacial till soil that is 20 to 40 inches deep to bedrock. The Hollis has a depth of 10 to 20 inches to bedrock. Rock Outcrop is exposed ledge. The hydrologic group for Chatfield is B. The hydrologic group for Hollis is C/D. There is no hydrologic group for Rock Outcrop, as it is impervious surface. The hydrologic group for this complex was assigned as B, as that represents the largest component of the complex.

135 – Chatfield Variant-Newfields Complex is located in bedrock-controlled landscapes. This is a case where the state-wide soil legend is not adequate to classify the soil types that are intermixed in the soil complex. While Newfields is present in the soil complex map unit, it is not one of the major components. Woodbridge is more dominant than Newfields. Newfields is a moderately well drained loose glacial till soil that has a hydrologic group of B. Woodbridge is a moderately well drained soil on dense glacial till and has a hydrologic group of C. Numerous test pits were conducted on site. At the end of the investigations, 37 Woodbridge soils, 32 Chatfield soil, and 6 Newfields were recorded on the site. So, Woodbridge is the largest component of this soil complex. The Chatfield Variant is a moderately well drained soil that is 20 to 40 inches deep. In this case, there were Chatfield Variant soils that had a dense till layer above the bedrock, which would make the hydrologic soil group for these pits more appropriately identified as C. Based upon the major component of this soil complex and based upon the Chatfield Variant soil profiles, this soil complex map unit was assigned a hydrologic group of C.

538 – Squamscott fine sandy loam is a poorly drained sand over marine silts soil that is commonly found along the Seacoast of New Hampshire. In this case, this soil represents the largest wetland on site. Inclusions would be Scitico silt loam and Ridgebury fine sandy loam.

656 – Ridgebury fine sandy loam is a poorly drained loamy soil that developed on dense glacial tills. These areas commonly have a perched water table. Inclusions would be Walpole fine sandy loam.

7. RESPONSIBLE SOIL SCIENTIST

James P. Gove, C.S.S. #004



8. OTHER DISTINGUISHING FEATURES OF SITE

This site has numerous rock outcrops at the higher elevations.

9. MAXIMUM SIZE OF LIMITING INCLUSIONS

15%

10. SPECIAL FEATURE SYMBOLS

None used.

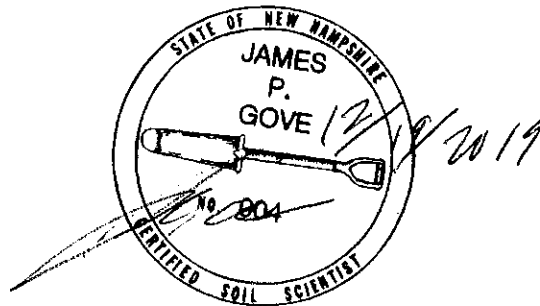

(This page is intentionally blank)

(This Page Is Intentionally Blank)

APPENDIX J
TEST PIT LOGS

(This Page Is Intentionally Blank)

Test Pit Log
Banfield Rd, Portsmouth
Logged By: Brenden Walden & James Gove
Date: 8/29 & 8/30, 2019

Test Pit #1:

0-8 INCHES, 10YR 3/3, FINE SANDY LOAM, GRANULAR, FRIABLE
8-30 INCHES, 10YR 4/6, FINE SANDY LOAM, GRANULAR, FRIABLE
ESHWT: 30 INCHES REFUSAL: 30 INCHES OBSERVED WATER: N/A

Test Pit #2:

0-9 INCHES, 10YR 3/3, FINE SANDY LOAM, GRANULAR, FRIABLE
9-28 INCHES, 10YR 4/6, FINE SANDY LOAM, GRANULAR, FRIABLE
ESHWT: 28 INCHES REFUSAL: 28 INCHES OBSERVED WATER: N/A

Test Pit #3:

0-10 INCHES, 10YR 3/3, FINE SANDY LOAM, GRANULAR, FRIABLE
10-30 INCHES, 10YR 4/6, FINE SANDY LOAM, GRANULAR, FRIABLE
30-57 INCHES, 2.5Y 5/3, FINE SANDY LOAM, GRANULAR, FRIABLE, WITH 20% REDOX CONCENTRATIONS
ESHWT: 30 INCHES REFUSAL: 57 INCHES OBSERVED WATER: N/A

Test Pit #4:

0-8 INCHES, 10YR 3/3, FINE SANDY LOAM, GRANULAR, FRIABLE
8-24 INCHES, 10YR 4/6, FINE SANDY LOAM GRANULAR, FRIABLE
ESHWT: 24 INCHES REFUSAL: 44 INCHES OBSERVED WATER: N/A

Test Pit #5:

0-6 INCHES, 10YR 3/3, FINE SANDY LOAM, GRANULAR, FRIABLE
6-25 INCHES, 10YR 4/6, FINE SANDY LOAM, GRANULAR, FRIABLE
25-51 INCHES, 2.5Y 5/3, FINE SANDY LOAM, PLATY, FIRM, WITH 10% REDOX, CONCENTRATIONS
ESHWT: 25 INCHES REFUSAL: 51 INCHES OBSERVED WATER: N/A

Test Pit #6:

0-8 INCHES, 10YR 3/3, FINE SANDY LOAM, GRANULAR, FRIABLE
8-28 INCHES, 10YR 4/6, FINE SANDY LOAM, GRANULAR, FRIABLE
28-60 INCHES, 2.5Y 5/3, FINE SANDY LOAM, PLATY, FIRM, WITH 20% REDOX CONCENTRATIONS
ESHWT: 28 INCHES REFUSAL: N/A OBSERVED WATER: N/A

Test Pit #7:

0-10 INCHES, 10YR 3/3, FINE SANDY LOAM, GRANULAR, FRIABLE
10- 41 INCHES, 10YR 4/6, FINE SANDY LOAM, GRANULAR, FRIABLE
41-64 INCHES, 2.5Y 5/3, FINE SANDY LOAM, PLATY, FIRM, WITH 10% REDOX CONCENTRATIONS
ESHWT:41 INCHES REFUSAL: N/A OBSERVED WATER: N/A

Test Pit #8:

0-7 INCHES, 10YR 3/3, FINE SANDY LOAM, GRANULAR, FRIABLE
7-28 INCHES, 10YR 4/6, FINE SANDY LOAM, GRANULAR, FRIABLE
28-53 INCHES, 2.5Y 5/3, FINE SANDY LOAM, PLATY, FIRM, WITH 20% REDOX CONCENTRATIONS
ESHWT: 28 INCHES REFUSAL: 53 INCHES OBSERVED WATER: N/A

Test Pit #10:

0-8 INCHES, 10YR 3/3, FINE SANDY LOAM, GRANULAR, FRIABLE
8-36 INCHES, 10YR 4/6, FINE SANDY LOAM, GRANULAR, FRIABLE
36-68 INCHES, 2.5Y 5/3, FINE SANDY LOAM, MASSIVE, FRIABLE, WITH 20% REDOX CONCENTRATIONS
ESHWT: 36 INCHES REFUSAL: N/A OBSERVED WATER: N/A

Test Pit #11:

0-8 INCHES, 10YR 3/3, FINE SANDY LOAM, GRANULAR, FRIABLE
8-28 INCHES, 10YR 4/6, FINE SANDY LOAM, GRANULAR, FRIABLE
28-64 INCHES, 2.5Y 5/3, FINE SANDY LOAM, PLATY, FIRM, WITH 10% REDOX CONCENTRATIONS
ESHWT: 28 INCHES REFUSAL: 64 INCHES OBSERVED WATER: N/A

Test Pit #13:

0-10 INCHES, 10YR 3/3, FINE SANDY LOAM, GRANULAR, FRIABLE
10-32 INCHES, 10YR 4/6, FINE SANDY LOAM, GRANULAR, FRIABLE
32-61 INCHES, 2.5Y 5/3, FINE SANDY LOAM, PLATY, FIRM, WITH 10% REDOX CONCENTRATIONS
ESHWT: 32 INCHES REFUSAL: 61 INCHES OBSERVED WATER: N/A

Test Pit #14A:

0-10 INCHES, 10YR 3/3, FINE SANDY LOAM, GRANULAR, FRIABLE
10-23 INCHES, 10YR 4/6, FINE SANDY LOAM, GRANULAR, FRIABLE
23-44 INCHES, 2.5Y 5/3, FINE SANDY LOAM, PLATY, FIRM, WITH 20% REDOX CONCENTRATIONS
ESHWT: 23 INCHES REFUSAL: 44 INCHES OBSERVED WATER: N/A

Test Pit #14B:

0-6 INCHES, 10YR 3/3, FINE SANDY LOAM, GRANULAR, FRIABLE
6-32 INCHES, 10YR 4/6, FINE SANDY LOAM, GRANULAR, FRIABLE
32-57 INCHES, 2.5Y 5/3, FINE SANDY LOAM, PLATY, FIRM, WITH 10 % REDOX CONCENTRATIONS
ESHWT: 32 INCHES REFUSAL: 57 INCHES OBSERVED WATER: N/A

Test Pit #15:

0-14 INCHES, 10YR 3/3, FINE SANDY LOAM, GRANULAR, FRIABLE
14-28 INCHES, 10YR 4/6, FINE SANDY LOAM, GRANULAR, FRIABLE
28-60 INCHES, 2.5Y 5/3, FINE SANDY LOAM, MASSIVE, FIRM, WITH 40% REDOX CONCENTRATIONS
ESHWT: 28 INCHES REFUSAL: 60 INCHES OBSERVED WATER: N/A

Test pit #16:

0-5 INCHES, 10YR 3/3, FINE SANDY LOAM, GRANULAR, FRIABLE

5-24 INCHES, 10YR 4/4, FINE SANDY LOAM, GRANULAR, FRIABLE

ESHWT: 24 INCHES REFUSAL: 24 INCHES OBSERVED WATER: N/A

Test Pit #17:

0-6 INCHES, 10YR 3/3, FINE SANDY LOAM, GRANULAR, FRIABLE

6-34 INCHES, 10YR 4/6, FINE SANDY LOAM, GRANULAR, FRIABLE

34-60 INCHES, 2.5Y 5/3, FINE SANDY LOAM, MASSIVE, FRIABLE, WITH 10% REDOX CONCENTRATIONS

ESHWT: 34 INCHES REFUSAL: 60 INCHES OBSERVED WATER: N/A

Test Pit #18:

0-6 INCHES, 10YR 3/3, FINE SANDY LOAM, GRANULAR, FRIABLE

6-22 INCHES, 10YR 4/6, FINE SANDY LOAM, GRANULAR, FRIABLE

22-50 INCHES, 2.5Y 5/3, FINE SANDY LOAM, PLATY, FIRM, WITH 10% REDOX CONCENTRATIONS

ESHWT: 22 INCHES REFUSAL: 50 INCHES OBSERVED WATER: N/A

Test Pit #19:

0-7 INCHES, 10YR 3/3, FINE SANDY LOAM, GRANULAR, FRIABLE

7-24 INCHES, 10YR 4/6, FINE SANDY LOAM, GRANULAR, FRIABLE

ESHWT: 24 INCHES REFUSAL: 24 INCHES OBSERVED WATER: N/A

Test Pit #21:

0-10 INCHES, 10YR 3/3, FINE SANDY LOAM, GRANULAR, FRIABLE

10-21 INCHES, 10YR 4/6, FINE SANDY LOAM, GRANULAR, FRIABLE

21-48 INCHES, 2.5Y 5/3, FINE SANDY LOAM, PLATY, FIRM, WITH 10% REDOX CONCENTRATIONS

ESHWT: 21 INCHES REFUSAL: 40 INCHES OBSERVED WATER: N/A

Test Pit #22:

0-6 INCHES, 10YR 3/3, FINE SANDY LOAM, GRANULAR, FRIABLE

6-20 INCHES, 10YR 4/6, FINE SANDY LOAM, GRANULAR, FRIABLE

20-58 INCHES, 2.5Y 5/3, FINE SANDY LOAM, PLATY, FIRM, WITH 10% REDOX CONCENTRATIONS

ESHWT: 20 INCHES REFUSAL: 58 INCHES OBSERVED WATER: N/A

Test Pit #E1:

0-10 INCHES, 10YR 3/3, FINE SANDY LOAM, GRANULAR, FRIABLE

10-22 INCHES, 10YR 4/6, FINE SANDY LOAM, GRANULAR, FRIABLE

22-51 INCHES, 2.5Y 5/3, FINE SANDY LOAM, PLATY, FIRM, 20% REDOX CONCENTRATIONS

ESHWT: 22 INCHES REFUSAL: 51 INCHES OBSERVED WATER: N/A

Test Pit #E2:

0-5 INCHES, 10YR 3/3, FINE SANDY LOAM, GRANULAR, FRIABLE

5-28 INCHES, 10YR 4/6, FINE SANDY LOAM, GRANULAR, FRIABLE

ESHWT: 28 INCHES REFUSAL: 28 INCHES OBSERVED WATER: N/A

Test Pit #E3:

0-8 INCHES, 10YR 3/3, FINE SANDY LOAM, GRANULAR, FRIABLE

8-32 INCHES, 10YR 4/6, FINE SANDY LOAM, GRANULAR, FRIABLE

32-74 INCHES, 2.5Y 5/3, FINE SANDY LOAM, PLATY, FIRM, WITH 10% REDOX CONCENTRATIONS

ESHWT: 32 INCHES

REFUSAL: 74 INCHES

OBSERVED WATER: N/A

Test Pit #E4:

0-9 INCHES, 10YR 3/3, FINE SANDY LOAM, GRANULAR, FRIABLE

9-28 INCHES, 10YR 4/6, FINE SANDY LOAM, GRANULAR, FRIABLE

28-50 INCHES, 2.5Y 5/3, FINE SANDY LOAM, PLATY, FIRM, WITH 10% REDOX CONCENTRATIONS

ESHWT: 28 INCHES

REFUSAL: 50 INCHES

OBSERVED WATER: N/A

Test Pit #E8:

0-8 INCHES, 10YR 3/3, FINE SANDY LOAM, GRANULAR, FRIABLE

8-27 INCHES, 2.5Y 4/6, FINE SANDY LOAM, GRANULAR, FRIABLE

27-62 INCHES, 2.5Y 5/3, FINE SANDY LOAM, PLATY, FIRM, WITH 10% REDOX CONCENTRATIONS

ESHWT: 27 INCHES

REFUSAL: N/A

OBSERVED WATER: N/A

Test Pit #100:

0-10 INCHES, 10YR 3/3, FINE SANDY LOAM, GRANULAR, FRIABLE

10-28 INCHES, 10YR 4/6, FINE SANDY LOAM, GRANULAR, FRIABLE

28-54 INCHES, 2.5Y 5/3, FINE SANDY LOAM, PLATY, FIRM, WITH 10% REDOX CONCENTRATIONS

ESHWT: 28 INCHES

REFUSAL: 54 INCHES

OBSERVED WATER: N/A

Test Pit #600:

0-8 INCHES, 10YR 3/3, FINE SANDY LOAM, GRANULAR, FRIABLE

8-21 INCHES, 10YR 4/6, FINE SANDY LOAM, GRANULAR, FRIABLE

21-47 INCHES, 2.5Y 5/3, FINE SANDY LOAM, PLATY, FIRM, WITH 10% REDOX CONCENTRATIONS

47-60 INCHES, 2.5Y 5/2, SILT LOAM, MASSIVE, FIRM, WITH 305 REDOX CONCENTRATIONS

ESHWT: 21 INCHES

REFUSAL: N/A

OBSERVED WATER: N/A

Test Pit Log

Banfield Rd

Date:

Logged By: Brenden Walden, Luke Hurley & Mike Coumo

Test Pit #5027:

0-3 INCHES, 10YR 3/2, FINE SANDY LOAM, GRANULAR, FRIABLE

3-20 INCHES, 10YR 5/5, FINE SANDY LOAM, GRANULAR, FRIABLE

ESHWT: N/A REFUSAL: 20 INCHES OBSERVED WATER: N/A

Test Pit #5026:

0-2 INCHES, 10YR 3/2, FINE SANDY LOAM, GRANULAR, FRIABLE

2-6 INCHES, 10YR 3/3, FINE SANDY LOAM, GRANULAR, FRIABLE

6-22 INCHES, 10YR 5/6, FINE SANDY LOAM, GRANULAR, FRIABLE

ESHWT: N/A REFUSAL: 22 INCHES OBSERVED WATER: N/A

Test Pit #5028:

0-2 INCHES, 10YR 3/2, FINE SANDY LOAM, GRANULAR, FRIABLE

2-4 INCHES, 10YR 3/3, FINE SANDY LOAM, GRANULAR, FRIABLE

4-36 INCHES, 10YR 4/4, FINE SANDY LOAM, GRANULAR, FRIABLE

ESHWT: N/A REFUSAL: 36 INCHES OBSERVED WATER: N/A

Test Pit #5093:

0-4 INCHES, 10YR 3/2, FINE SANDY LOAM, GRANULAR, FRIABLE

4-12 INCHES, 10YR 4/3, GRAVELY FINE SANDY LOAM, GRANULAR, FRIABLE

12-22 INCHES, 10YR 5/4, GRAVELY FINE SANDY LOAM, GRANULAR, FRIABLE

22-36 INCHES, 2.5Y 6/4, GRAVELY FINE SANDY LOAM, GRANULAR, FRIABLE

ESHWT: N/A REFUSAL: 36 INCHES OBSERVED WATER: N/A

Test Pit # 5029:

0-2 INCHES, 10YR 3/2, FINE SANDY LOAM, GRANULAR, FRIABLE

2-8 INCHES, 10YR 4/3, GRAVELY FINE SANDY LOAM, GRANULAR, FRIABLE

8-24 INCHES, 10YR 5/4, GRAVELY FINE SANDY LOAM, GRANULAR, FRIABLE

24-40 INCHES, 2.5Y 6/4, GRAVELY FINE SANDY LOAM, GRANULAR, FRIABLE

40-44 INCHES, 2.5Y 6/4, GRAVELY FINE SANDY LOAM, GRANULAR FRIABLE, WITH 10% REDOX CONCENTRATIONS

ESHWT: 40 INCHES REFUSAL: 44 INCHES OBSERVED WATER: N/A

Test Pit #5094:

0-2 INCHES, 10YR 3/2, FINE SANDY LOAM, GRANULAR, FRIABLE

2-12 INCHES, 2.5Y 5/4, GRAVELY FINE SANDY LOAM, GRANULAR, FRIABLE

12-32 INCHES, 2.5Y 6/4, FINE SANDY LOAM, GRANULAR, FRIABLE

32-54 INCHES, 2.5Y 5/4, FINE SANDY LOAM, PLATY, FIRM, WITH 20% REDOX CONCENTRATIONS

ESHWT: 32 INCHES

REFUSAL: 54 INCHES

OBSERVED WATER: N/A

Test Pit #5038:

0-3 INCHES, 10YR 3/2, FINE SANDY LOAM, GRANULAR, FRIABLE

3-8 INCHES, 2.5Y 6/4, FINE SANDY LOAM, GRANULAR, FRIABLE

8-30 INCHES, 2.5Y 7/4, GRAVELY FINE SANDY LOAM, GRANULAR, FRIABLE

30-40 INCHES, 2.5Y 6/4, GRAVELY FINE SANDY LOAM, MASSIVE, FIRM, WITH 10% REDOX CONCENTRATIONS

ESHWT: 30 INCHES

REFUSAL: 40 INCHES

OBSERVED WATER: N/A

Test Pit #5095:

0-2 INCHES, 10YR 3/2, FINE SANDY LOAM, GRANULAR, FRIABLE

2-12 INCHES, 2.5Y 6/4, FINE SANDY LOAM, GRANULAR, FRIABLE

12-32 INCHES, 2.5Y 7/4, FINE SANDY LOAM, MASSIVE, FIRM WITH 10% REDOX CONCENTRATIONS

ESHWT: 12 INCHES

REFUSAL: 32 INCHES

OBSERVED WATER: N/A

Test Pit #5040/62

0-3 INCHES, 10YR 3/2, FINE SANDY LOAM, GRANULAR, FRIABLE

3-30 INCHES, 2.5Y 5/4, FINE SANDY LOAM, GRANULAR, FRIABLE

30-38 INCHES, 2.5Y 5/6, GRAVELY FINE SANDY LOAM, MASSIVE, FIRM

ESHWT: N/A

REFUSAL: 38 INCHES

OBSERVED WATER: N/A

Test Pit #5041/63:

0-3 INCHES, 10YR 3/2, FINE SANDY LOAM, GRANULAR, FRIABLE

3-20 INCHES, 10YR 4/6, FINE SANDY LOAM, GRANULAR, FRIABLE

ESHWT: N/A

REFUSAL: 20 INCHES

OBSERVED WATER: N/A

Test Pit #5039/61:

0-3 INCHES, 10YR 3/2, FINE SANDY LOAM, GRANULAR, FRIABLE

3-24 INCHES, 2.5Y 4/6, FINE SANDY LOAM, GRANULAR, FRIABLE

ESHWT: N/A

REFUSAL: 24 INCHES

OBSERVED WATER: N/A

Test Pit #5096:

0-3 INCHES, 10YR 3/2, FINE SANDY LOAM, GRANULAR, FRIABLE

3-16 INCHES, 10YR 5/6, FINE SANDY LOAM, GRANULAR, FRIABLE

16-34 INCHES, 2.5Y 6/4, FINE SANDY LOAM, GRANULAR, FRIABLE

ESHWT: N/A

REFUSAL: 34 INCHES

OBSERVED WATER: N/A

Test Pit #5038B:

0-2 INCHES, 10YR 3/2, FINE SANDY LOAM, GRANULAR, FRIABLE

2-14 INCHES, 10YR 5/6, FINE SANDY LOAM, GRANULAR, FRIABLE

14-24 INCHES, 2.5Y 6/4, GRAVELY FINE SANDY LOAM, GRANULAR, FRIABLE

24-29 INCHES, 2.5Y 6/3, FINE SANDY LOAM, MASSIVE, FIRM

29-40 INCHES, 2.5Y 6/3, FINE SANDY LOAM, MASSIVE, FIRM, WITH 10% REDOX CONCENTRATIONS

ESHWT: 29 INCHES

REFUSAL: 40 INCHES

OBSERVED WATER: N/A

Test Pit #5037/59:

0-4 INCHES, 10YR 3/2, FINE SANDY LOAM, GRANULAR, FRIABLE

4-15 INCHES, 2.5Y 5/4, FINE SANDY LOAM, GRANULAR, FRIABLE

15-34 INCHES, 2.5Y 6/4, FINE SANDY LOAM, GRANULAR, FRIABLE

34-40 INCHES, 2.5Y 6/3, FINE SANDY LOAM, MASSIVE, FIRM, WITH 10% REDOX CONCENTRATIONS

ESHWT: 34 INCHES

REFUSAL: 40 INCHES

OBSERVED WATER: N/A

Test Pit #5036/57:

0-2 INCHES, 10YR 3/3, FINE SANDY LOAM, GRANULAR, FRIABLE

2-12 INCHES, 10YR 4/4, FINE SANDY LOAM, GRANULAR, FRIABLE

12-26 INCHES, 2.5Y 5/3, GRAVELY FINE SANDY LOAM, GRANULAR, FRIABLE

26-34 INCHES, 2.5Y 5/5, GRAVELY FINE SANDY LOAM, MASSIVE, FIRM, WITH 10% REDOX CONCENTRATIONS

ESHWT: 26 INCHES

REFUSAL: 34 INCHES

OBSERVED WATER: N/A

Test Pit #5035/58:

0-3 INCHES, 10YR 2/2, FINE SANDY LOAM, GRANULAR, FRIABLE

3-23 INCHES, 2.5Y 5/4, FINE SANDY LOAM, GRANULAR, FRIABLE

23-55 INCHES, 2.5Y 5/2, FINE SANDY LOAM, MASSIVE, FIRM, WITH 25% REDOX CONCENTRATIONS

ESHWT: 23 INCHES

REFUSAL: N/A

OBSERVED WATER: N/A

Test Pit #5034/56:

0-4 INCHES, 10YR 3/2, FINE SANDY LOAM, GRANULAR, FRIABLE

4-20 INCHES, 2.5Y 5/4, FINE SANDY LOAM, GRANULAR, FRIABLE

20-36 INCHES, 2.5Y 5/4, FINE SANDY LOAM, MASSIVE, FIRM, WITH 10% REDOX CONCENTRATIONS

ESHWT: 20 INCHES

REFUSAL: 36 INCHES

OBSERVED WATER: N/A

Test Pit #5033:

0-2 INCHES, 10YR 3/3, FINE SANDY LOAM, GRANULAR, FRIABLE

2-15 INCHES, 10YR 5/6, FINE SANDY LOAM, GRANULAR, FRIABLE

15-23 INCHES, 2.5Y 6/4, FINE SANDY LOAM, GRANULAR, FRIABLE

23-52 INCHES, 2.5Y 4/3, FINE SANDY LOAM, MASSIVE, FIRM, WITH 30% REDOX CONCENTRATIONS

ESHWT: 23 INCHES

REFUSAL: N/A

OBSERVED WATER: N/A

Test Pit #5031:

0-5 INCHES, 10YR 3/2, FINE SANDY LOAM, GRANULAR, FRIABLE

5-12 INCHES, 10YR 4/4, FINE SANDY LOAM, GRANULAR, FRIABLE

12-24 INCHES, 2.5Y 5/4, FINE SANDY LOAM, GRANULAR, FRIABLE

24-40 INCHES, 2.5Y 6/4, FINE SANDY LOAM, MASSIVE, FIRM, WITH 10% REDOX CONCENTRATIONS

ESHWT: 24 INCHES

REFUSAL: 40 INCHES

OBSERVED WATER: N/A

Test Pit #5032:

0-3 INCHES, 10YR 3/2, FINE SANDY LOAM, GRANULAR, FRIABLE
3-6 INCHES, 10YR 4/4, FINE SANDY LOAM, GRANULAR, FRIABLE
6-14 INCHES, 2.5Y 5/4, FINE SANDY LOAM, GRANULAR, FRIABLE
14-36 INCHES, 2.5Y 6/4, FINE SANDY LOAM, GRANULAR, FRIABLE
ESHWT: N/A REFUSAL: 36 INCHES OBSERVED WATER: N/A

Test Pit #5084/52:

0-6 INCHES, 10YR 3/2, FINE SANDY LOAM, GRANULAR, FRIABLE
6-24 INCHES, 2.5Y 5/6, GRAVELY FINE SANDY LOAM, GRANULAR, FRIABLE
24-38 INCHES, 2.5Y 5/6, GRAVELY FINE SANDY LOAM, GRANULAR, FRIABLE, WITH 10% REDOX CONCENTRATIONS
ESHWT: 24 INCHES REFUSAL: 38 INCHES OBSERVED WATER: N/A

Test Pit #5038/51:

0-4 INCHES, 10YR 3/3, FINE SANDY LOAM, GRANULAR, FRIABLE
4-14 INCHES, 10YR 4/6, FINE SANDY LOAM, GRANULAR, FRIABLE
14-24 INCHES, 6/4, GRAVELY FINE SANDY LOAM, MASSIVE, FIRM
24-60 INCHES, 2.5Y 5/2, SILT LOAM, BLOCKY, FIRM, WITH 25% REDOX CONCENTRATIONS
ESHWT: 24 INCHES REFUSAL: N/A OBSERVED WATER: N/A

Test Pit #5086/53:

0-6 INCHES, 10YR 3/3, FINE SANDY LOAM, GRANULAR, FRIABLE
6-24 INCHES, 2.5Y 5/6, FINE SANDY LOAM, GRANULAR, FRIABLE
24-68 INCHES, 2.5Y 5/2, FINE SANDY LOAM, MASSIVE, FIRM, WITH 50% REDOX CONCENTRATIONS
ESHWT: 24 INCHES REFUSAL: N/A OBSERVED WATER: N/A

Test Pit #5085/54:

0-4 INCHES, 10YR 3/2, FINE SANDY LOAM, GRANULAR, FRIABLE
4-24 INCHES, 10YR 5/6, FINE SANDY LOAM, GRANULAR, FRIABLE
ESHWT: N/A REFUSAL: 24 INCHES OBSERVED WATER: N/A

Test Pit #5023:

0-2 INCHES, 10YR 3/3, FINE SANDY LOAM, GRANULAR, FRIABLE
2-24 INCHES, 10YR 5/6, FINE SANDY LOAM, GRANULAR, FRIABLE
24-36 INCHES, 2.5Y 4/4, FINE SANDY LOAM, GRANULAR, FRIABLE
36-44 INCHES, 2.5Y 4/4, FINE SANDY LOAM, GRANULAR, FRIABLE, WITH 10% REDOX CONCENTRATIONS
ESHWT: 36 INCHES REFUSAL: 44 INCHES OBSERVED WATER: N/A

Test Pit #5024:

0-4 INCHES, 10YR 3/2, FINE SANDY LOAM, GRANULAR, FRIABLE
4-18 INCHES, 2.5Y 6/4, FINE SANDY LOAM, GRANULAR, FRIABLE
18-32 INCHES, 2.5Y 5/4, FINE SANDY LOAM, GRANULAR, FRIABLE
ESHWT: N/A REFUSAL: 32 INCHES OBSERVED WATER: N/A

Test Pit #5025:

0-3 INCHES, 10YR 3/2, FINE SANDY LOAM, GRANULAR, FRIABLE

3-7 INCHES, 10YR 3/3, FINE SANDY LOAM, GRANULAR, FRIABLE

7-32 INCHES, 10YR 4/4, FINE SANDY LOAM, GRANULAR, FRIABLE

ESHWT: N/A

REFUSAL: 32 INCHES

OBSERVED WATER: N/A

Number	ESHWT	REFUSAL	DEPTH
LEDGE PROBES			
5001	N/A	47	47
5002	N/A	N/A	52
5003	N/A	32	32
5004	N/A	36	36
5005	N/A	32	32
5006	N/A	36	36
5007	N/A	36	36
5008	N/A	24	24
5009	N/A	30	30
5010	N/A	34	34
5011	N/A	22	22
5012	N/A	42	42
5013	N/A	24	24
5014	N/A	30	30
5015	N/A	24	24
5016	N/A	32	32
5017	N/A	48	48
5018	N/A	N/A	46
5019	N/A	32	32
5020	N/A	46	46
5021	N/A	N/A	41
5022	N/A	N/A	66

(This Page Is Intentionally Blank)

APPENDIX K
NHDES ONE STOP DATA MAPPER

(This Page Is Intentionally Blank)

Banfield Road - Portsmouth, NH

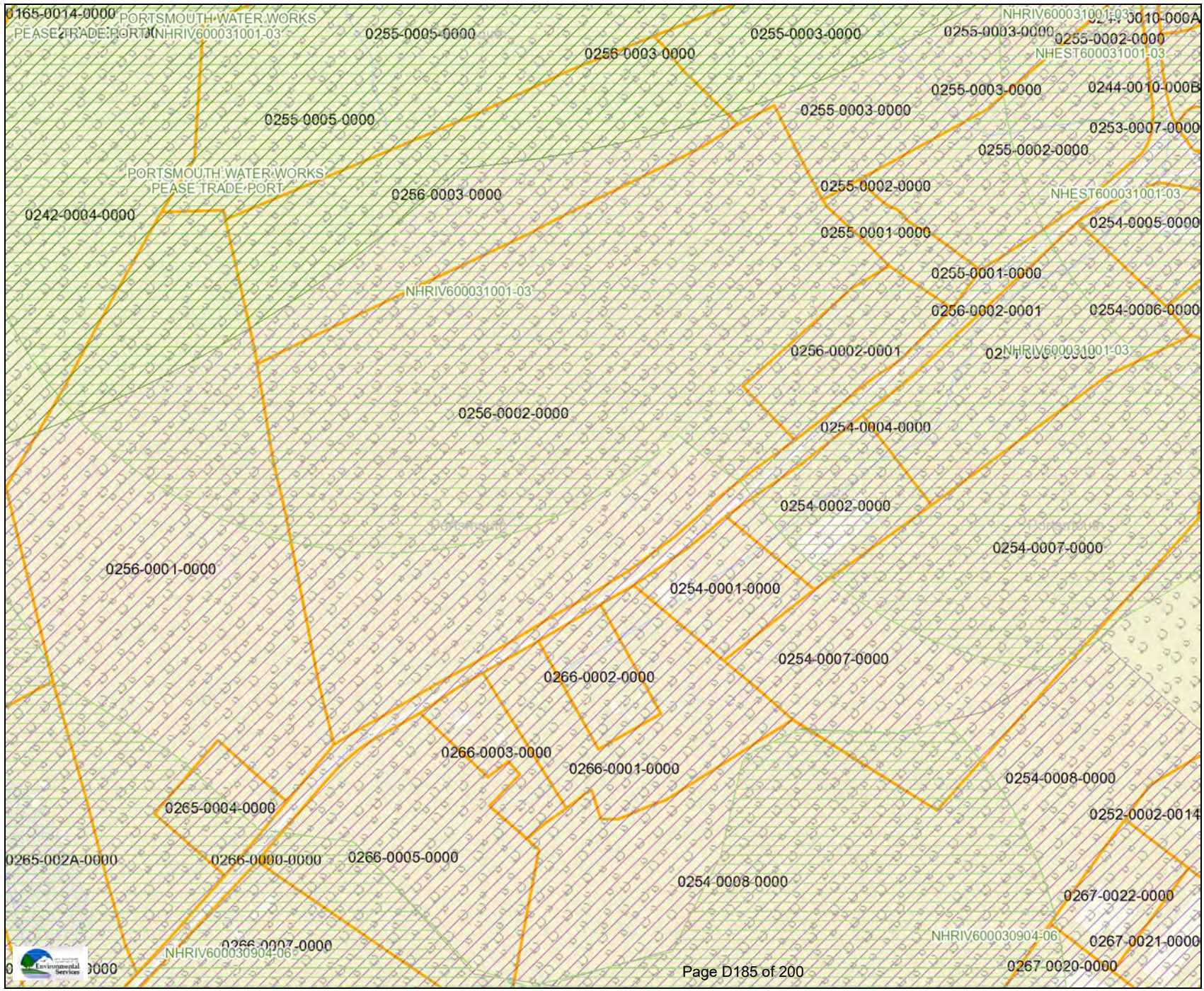

Legend

- ☐ Coastal and Great Bay Regional Communities
- ☐ Designated Rivers Quarter Mile Buffer
- Public Water Supply Wells
- ☐ Groundwater Classification / GA1
- ☐ Groundwater Classification / GA2
- ☐ Water Supply Intake Protect Areas
- ☐ Wellhead Protection Areas
- ☐ Lakes with a Quarter Mile Buffer
- ☐ All Features
- ☐ All Lakes, with a Quarter Mile Buffer
- ☐ Outstanding Resource Water Watersheds
- ☐ Surface Waters with Impairment 2016 with Quarter Mile Buffer
- ☐ Watersheds with Chloride Impairments 2016
- ☐ Parcels - polygons

Map Scale
 1: 5,000



© NH DES, <http://des.nh.gov>
 Map Generated: 10/3/2019

Notes



(This page is intentionally blank)

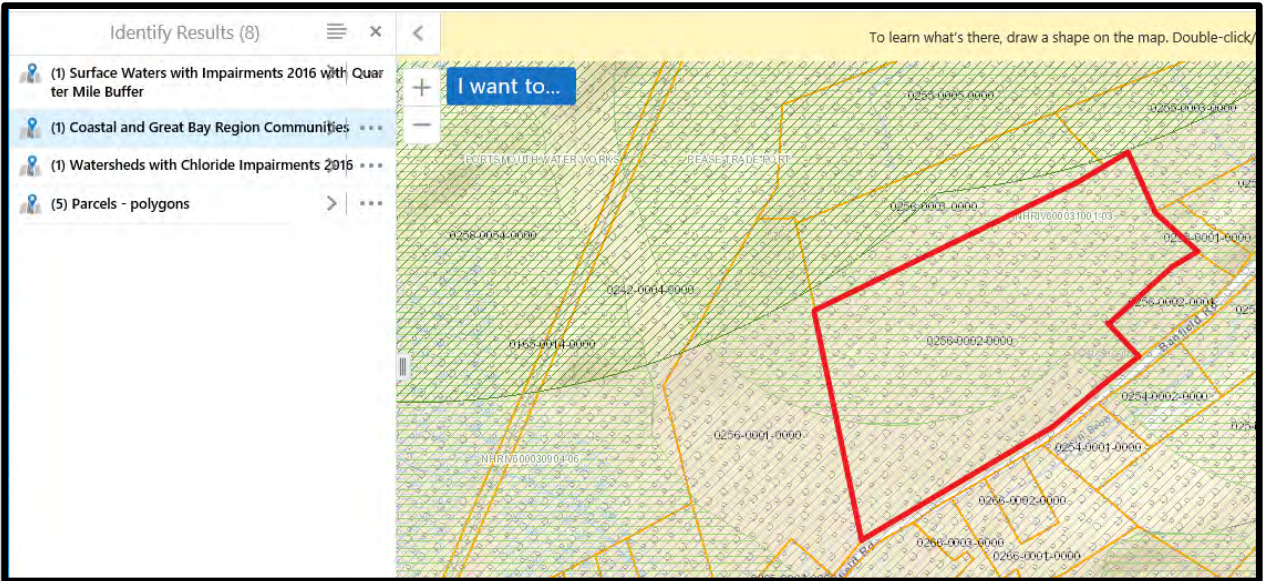

Description

Assessment Unit ID (AUID): NHRIV600031001-03

Assessment Unit Name: SAGAMORE CREEK

Beach (Y/N?): N

Impairments related to stormwater: Chloride, Escherichia coli

[Metadata](#)

Details

- AUID
NHRIV600031001-03 [NHRIV600031001-03](#) N/A
- FID
387 [387](#) N/A
- Waterbodyi
NHRIV600031001-03 [NHRIV600031001-03](#) N/A
- Waterbodyyn
SAGAMORE CREEK [SAGAMORE CREEK](#) N/A
- Impairment
Chloride, Escherichia coli

Details

- FID
8 [8](#) N/A
- OBJECTID_1
3282 [3282](#) N/A
- AUID
NHRIV600031001-03 [NHRIV600031001-03](#) N/A
- Shape_Leng
17891.5112 [17891.5112](#) N/A
- QAQC
Good [Good](#) N/A
- Method
10m DEM, 24k NHHD Burned and Catchment Walled [10m DEM, 24k NHHD Burned and Catchment Walled](#) N/A
- Mod_Date
Apr 8, 2013 8:00 PM [Apr 8, 2013 8:00 PM](#) N/A
- CYCLE
2014 [2014](#) N/A
- USE_ID
952 [952](#) N/A
- IMPAIRMENT
138 [138](#) N/A
- IMPAIRMEN2
Chloride [Chloride](#) N/A
- DESCATEGOR
5-M

APPENDIX L
PRE AND POST DRAINAGE PLANS

(This Page Is Intentionally Blank)

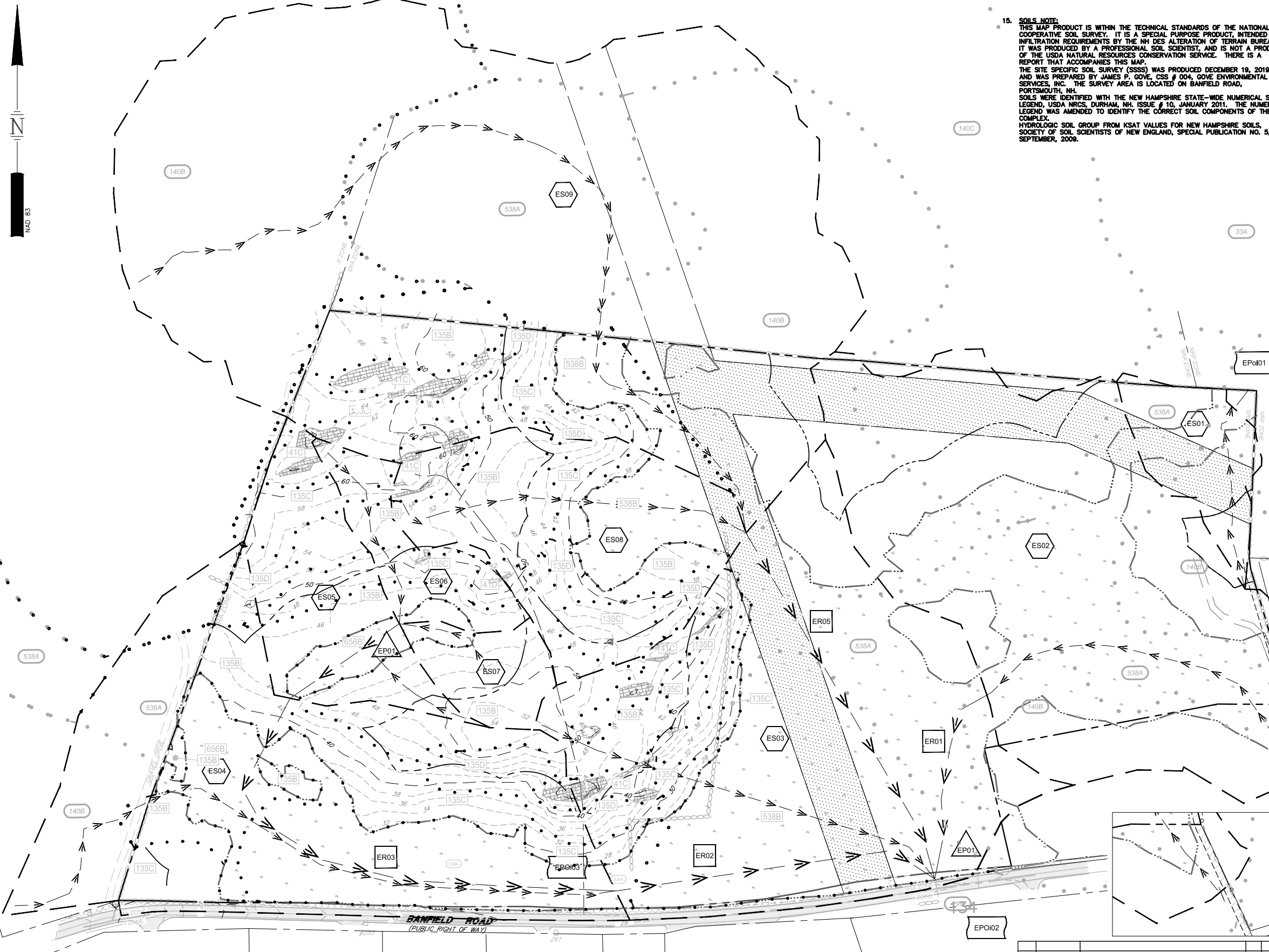

15. SOILS NOTE:
 THIS MAP PRODUCT IS WITHIN THE TECHNICAL STANDARDS OF THE NATIONAL COOPERATIVE SOIL SURVEY. IT IS A SPECIAL PURPOSE PRODUCT, INTENDED FOR INFILTRATION REQUIREMENTS BY THE NH DES ALTERATION OF TERRAIN BUREAU. IT WAS PRODUCED BY A PROFESSIONAL SOIL SCIENTIST, AND IS NOT A PRODUCT OF THE USDA NATURAL RESOURCES CONSERVATION SERVICE. THERE IS A REPORT THAT ACCOMPANIES THIS MAP.
 THE SITE SPECIFIC SOIL SURVEY (SSSS) WAS PRODUCED DECEMBER 19, 2019 AND WAS PREPARED BY JAMES P. GOVE, CSS # 004, GOVE ENVIRONMENTAL SERVICES, INC. THE SURVEY AREA IS LOCATED ON BANFIELD ROAD, PORTSMOUTH, NH.
 SOILS WERE IDENTIFIED WITH THE NEW HAMPSHIRE STATE-WIDE NUMERICAL SOILS LEGEND, USDA NRCS, DURHAM, NH, ISSUE # 10, JANUARY 2011. THE NUMERIC LEGEND WAS AMENDED TO IDENTIFY THE CORRECT SOIL COMPONENTS OF THE COMPLEX.
 HYDROLOGIC SOIL GROUP FROM KSAT VALUES FOR NEW HAMPSHIRE SOILS, SOCIETY OF SOIL SCIENTISTS OF NEW ENGLAND, SPECIAL PUBLICATION NO. 5, SEPTEMBER, 2009.

LEGEND

- FLOW PATH (Tc LINE)
- REACH
- SOIL GROUP BREAK LINE
- EXISTING LOT LINE
- LIMITS OF SUBCATCHMENT
- EXISTING SUBCATCHMENT NODE
- EXISTING REACH
- EXISTING POND AREA AND CULVERT NODE
- POINT OF INTEREST

SOIL LEGEND PER USDA NRCS WEB SOIL SURVEY

NRCS SYMBOL	NRCS DESCRIPTION	PERCENT	HYDROLOGIC SOIL GROUP
38B	ELDRIDGE FINE SANDY LOAM, 8% SLOPES	3%	C/D
140B	CHATFIELD-HOLLIS-CANTON COMPLEX, 0% - 8%		B
140C	CHATFIELD-HOLLIS-CANTON COMPLEX, 8% - 15%		B
538A	SQUAMSCOTT FINE SANDY LOAM, 0% - 5%		C/D

SOIL LEGEND PER SITE SPECIFIC SOIL SURVEY (SSS)

SSS SYMBOL	SSS MAP NAME	HYDROLOGIC SOIL GROUP
41	CHATFIELD-HOLLIS-ROCK OUTCROP COMPLEX	B
135	CHATFIELD VARIANT-NEWFIELDS COMPLEX	C
538	SQUAMSCOTT FINE SANDY LOAM	C
656	RIDGEBURY FINE SANDY LOAM	C

SLOPE PHASE:		
0-8%	B	
8-15%	C	
15-25%	D	
25%+	E	

SITE DEVELOPMENT PLANS

TAX MAP 256 LOT 2
PRE-DEVELOPMENT DRAINAGE PLAN OVERALL
THE VILLAGE AT BANFIELD WOODS
PORTSMOUTH, NH
 OWNED BY
WALTER D HETT TRUST
 PREPARED FOR
GREEN & COMPANY REAL ESTATE
1"=200' (11"X17")
SCALE: 1"=100' (22"X34") **SEPTEMBER 25, 2019**

Copyright 2019 © Thomas F. Moran, Inc.
 48 Constitution Drive, Bedford, N.H. 03110
 All rights reserved. These plans and materials may not be copied, duplicated, replicated or otherwise reproduced in any form whatsoever without the prior written permission of Thomas F. Moran, Inc.
 This plan is not effective unless signed by a duly authorized officer of Thomas F. Moran, Inc.

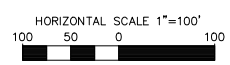

REV	DATE	DESCRIPTION	DR	CK
6	5/5/2020	AoT SUBMITTAL	RCK	JJM
5	4/29/2020	REVISOR PER REGULATORY COMMENTS	RCK	JJM
4	3/20/2020	PROGRESS PRINT	RCK	JJM
3	3/4/2020	UPDATE PLANS PER REGULATORY COMMENTS	RCK	JJM
2	12/27/2019	IN HOUSE REVISIONS	RCK	JJM
1	5/5/2020	AoT SUBMITTAL	RCK	JJM

TFM Civil Engineers
 Structural Engineers
 Traffic Engineers
 Land Surveyors
 Landscape Architects
 Scientists

48 Constitution Drive
 Bedford, NH 03110
 Phone (603) 472-4488
 Fax (603) 472-9747
 www.tfmoran.com

FILE: 47361.00 DR RCK FB
 CK JIM CADFILE PRE-POST_DRAINAGE D-01

May 06, 2020 - 9:03am F:\MISC Projects\47361 - Portsmouth\47361-00 - Green & Co. - Banfield Road\Design\Production Drawings\Pre-Post_Drainage.dwg

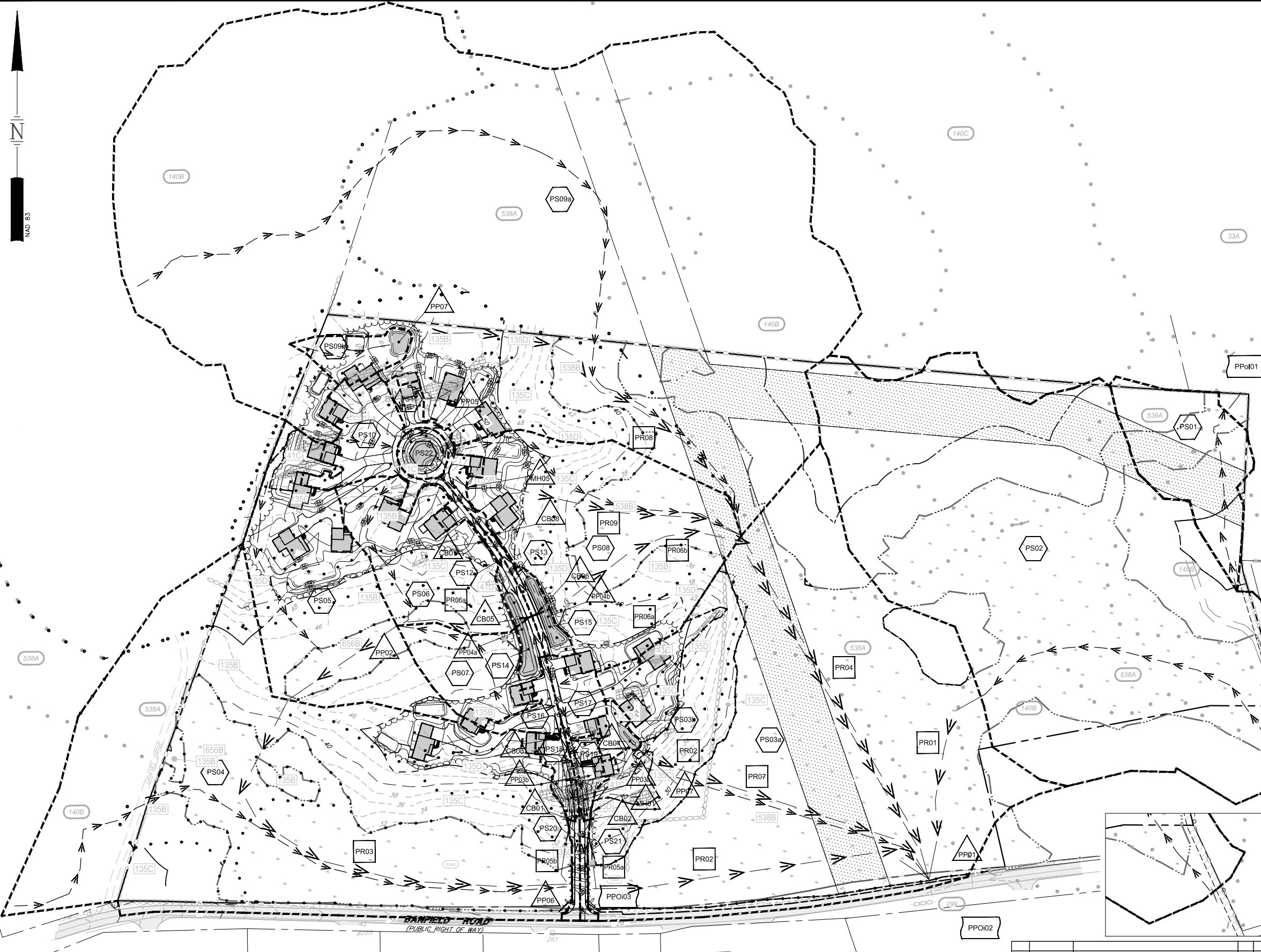

LEGEND

- FLOW PATH (Tc LINE)
- REACH
- SOIL GROUP BREAK LINE
- EXISTING LOT LINE
- LIMITS OF SUBCATCHMENT
- PROPOSED SUBCATCHMENT NODE
- PROPOSED REACH
- PROPOSED POND AREA AND CULVERT NODE
- POINT OF INTEREST

SOIL LEGEND PER USDA NRCS WEB SOIL SURVEY

NRCS SYMBOL	NRCS DESCRIPTION	PERCENTAGE	HYDROLOGIC SOIL GROUP
38B	ELDRIDGE FINE SANDY LOAM, 8% SLOPES	3%	C/D
140B	CHATFIELD-HOLLIS-CANTON COMPLEX, 0% - 8%		B
140C	CHATFIELD-HOLLIS-CANTON COMPLEX, 8% - 15%		B
538A	SQUAMSCOTT FINE SANDY LOAM, 0% - 5%		C/D

SOIL LEGEND PER SITE SPECIFIC SOIL SURVEY (SSS)

SSS SYMBOL	SSS MAP NAME	HYDROLOGIC SOIL GROUP
41	CHATFIELD-HOLLIS-ROCK OUTCROP COMPLEX	B
135	CHATFIELD VARIANT-NEWFIELDS COMPLEX	C
538	SQUAMSCOTT FINE SANDY LOAM	C
656	RIDGEBURY FINE SANDY LOAM	C

SLOPE PHASE:	
0-8%	B
8-15%	C
15-25%	D
25%+	E

SITE DEVELOPMENT PLANS

TAX MAP 256 LOT 2
POST DEVELOPMENT DRAINAGE PLAN OVERALL
THE VILLAGE AT BANFIELD WOODS
PORTSMOUTH, NH
 OWNED BY
WALTER D HETT TRUST
 PREPARED FOR
GREEN & COMPANY REAL ESTATE
1"=200' (11"X17")
SCALE: 1"=100' (22"X34") **SEPTEMBER 25, 2019**

REV	DATE	DESCRIPTION	DR	CK
6	5/5/2020	AoT SUBMITTAL	RCK	JJM
5	4/29/2020	REVISOR PER REGULATORY COMMENTS	RCK	JJM
4	3/20/2020	PROGRESS PRINT	RCK	JJM
3	3/4/2020	UPDATE PLANS PER REGULATORY COMMENTS	RCK	JJM
2	12/27/2019	IN HOUSE REVISIONS	RCK	JJM
1	5/5/2020	AoT SUBMITTAL	RCK	JJM

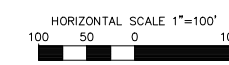

Copyright 2019 © Thomas F. Moran, Inc.
 48 Constitution Drive, Bedford, N.H. 03110

All rights reserved. These plans and materials may not be copied, duplicated, replicated or otherwise reproduced in any form whatsoever without the prior written permission of Thomas F. Moran, Inc.

This plan is not effective unless signed by a duly authorized officer of Thomas F. Moran, Inc.

May 06, 2020 - 9:03am
 F:\MISC Projects\47361 - Portsmouth\47361-00 - Green & Co. - Banfield Road\Design\Production Drawings\Pre-Post_Drainage.dwg

	Civil Engineers Structural Engineers Traffic Engineers Land Surveyors Landscape Architects Scientists	48 Constitution Drive Bedford, NH 03110 Phone (603) 472-4488 Fax (603) 472-9747 www.tfmoran.com
	47361.00	DR RCK FB CK JJM CADFILE

D-02

May 06, 2020 - 9:03am F:\MISC Projects\47361 - Portsmouth\47361-00 - Green & Co - Banfield Road\Design\Production Drawings\Pre-Post_Drainage.dwg

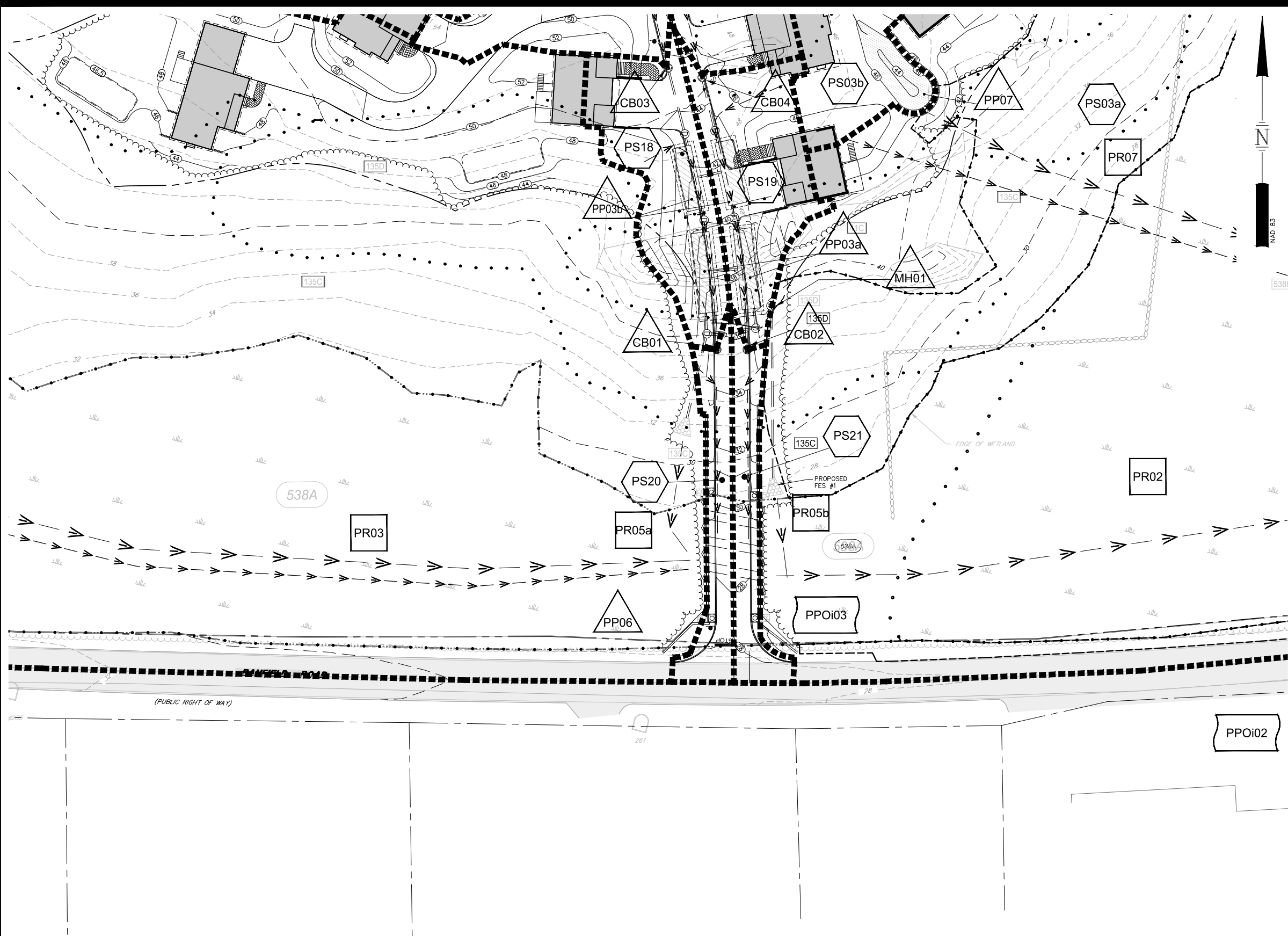

LEGEND

- FLOW PATH (Tc LINE)
- REACH
- SOIL GROUP BREAK LINE
- EXISTING LOT LINE
- LIMITS OF SUBCATCHMENT
- PROPOSED SUBCATCHMENT NODE
- PROPOSED REACH
- PROPOSED POND AREA AND CULVERT NODE
- POINT OF INTEREST

SOIL LEGEND PER USDA NRCS WEB SOIL SURVEY

NRCS SYMBOL	NRCS DESCRIPTION	PERCENTAGE	HYDROLOGIC SOIL GROUP
38B	ELDRIDGE FINE SANDY LOAM, - 8% SLOPES	3%	C/D
140B	CHATFIELD-HOLLIS-CANTON COMPLEX, 0% - 8%		B
140C	CHATFIELD-HOLLIS-CANTON COMPLEX, 8% - 15%		B
538A	SQUAMSCOTT FINE SANDY LOAM, 0% - 5%		C/D

SOIL LEGEND PER SITE SPECIFIC SOIL SURVEY (SSS)

SSS SYMBOL	SSS MAP NAME	HYDROLOGIC SOIL GROUP
41	CHATFIELD-HOLLIS-ROCK OUTCROP COMPLEX	B
135	CHATFIELD VARIANT-NEWFIELDS COMPLEX	C
538	SQUAMSCOTT FINE SANDY LOAM	C
656	RIDGEBURY FINE SANDY LOAM	C

SLOPE PHASE:	
0-8%	B
8-15%	C
15-25%	D
25%+	E

SITE DEVELOPMENT PLANS

TAX MAP 256 LOT 2
POST DEVELOPMENT DRAINAGE PLAN
THE VILLAGE AT BANFIELD WOODS
PORTSMOUTH, NH

OWNED BY
WALTER D HETT TRUST
 PREPARED FOR
GREEN & COMPANY REAL ESTATE
1"=60' (11"X17')
SCALE: 1"=30' (22"X34') **SEPTEMBER 25, 2019**

Copyright 2019 © Thomas F. Moran, Inc.
 48 Constitution Drive, Bedford, N.H. 03110

All rights reserved. These plans and materials may not be copied, duplicated, replicated or otherwise reproduced in any form whatsoever without the prior written permission of Thomas F. Moran, Inc.

This plan is not effective unless signed by a duly authorized officer of Thomas F. Moran, Inc.

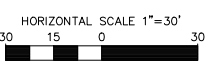

REV	DATE	DESCRIPTION	DR	CK
6	5/5/2020	AoT SUBMITTAL	RCK	JJM
5	4/29/2020	REVISOR PER REGULATORY COMMENTS	RCK	JJM
4	3/20/2020	PROGRESS PRINT	RCK	JJM
3	3/4/2020	UPDATE PLANS PER REGULATORY COMMENTS	RCK	JJM
2	12/27/2019	IN HOUSE REVISIONS	RCK	JJM
1	5/5/2020	AoT SUBMITTAL	RCK	JJM

Civil Engineers
 Structural Engineers
 Traffic Engineers
 Land Surveyors
 Landscape Architects
 Scientists

48 Constitution Drive
 Bedford, NH 03110
 Phone (603) 472-4488
 Fax (603) 472-9747
 www.tfmoran.com

FILE: 47361.00 DR RCK FB
 CK JIM CADFILE PRE-POST_DRAINAGE D-03

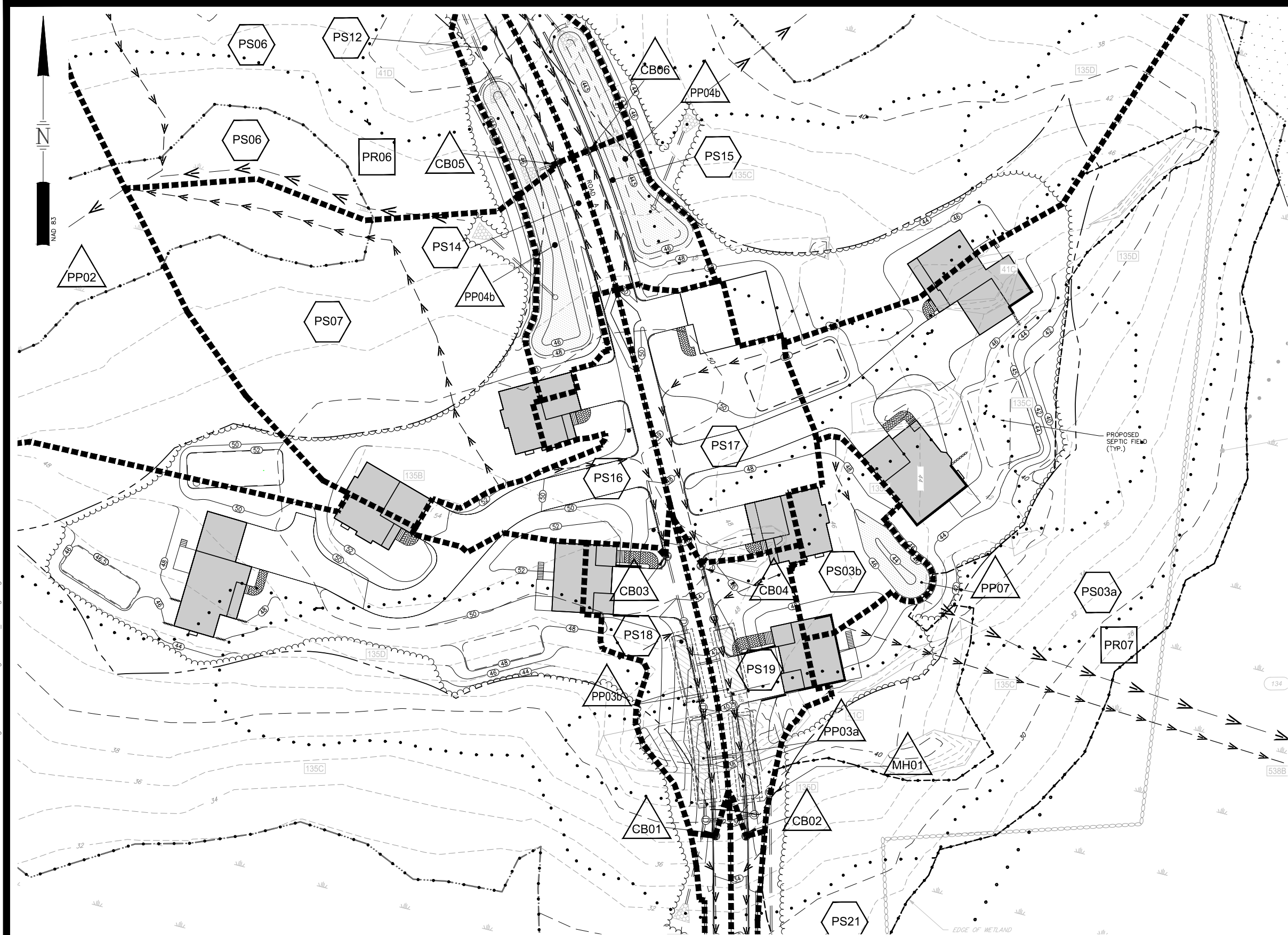

LEGEND

- FLOW PATH (Tc LINE)
- REACH
- SOIL GROUP BREAK LINE
- EXISTING LOT LINE
- LIMITS OF SUBCATCHMENT
- ES4 PROPOSED SUBCATCHMENT NODE
- ER1 PROPOSED REACH
- EC1 PROPOSED POND AREA AND CULVERT NODE
- PPOi3 POINT OF INTEREST

SOIL LEGEND PER USDA NRCS WEB SOIL SURVEY

NRCS SYMBOL	NRCS DESCRIPTION	PERCENT SLOPE	HYDROLOGIC SOIL GROUP
38B	ELDRIDGE FINE SANDY LOAM, - 8% SLOPES	3%	C/D
140B	CHATFIELD-HOLLIS-CANTON COMPLEX, 0% - 8%		B
140C	CHATFIELD-HOLLIS-CANTON COMPLEX, 8% - 15%		B
538A	SQUAMSCOTT FINE SANDY LOAM, 0% - 5%		C/D

SOIL LEGEND PER SITE SPECIFIC SOIL SURVEY (SSS)

SSS SYMBOL	SSS MAP NAME	HYDROLOGIC SOIL GROUP
41	CHATFIELD-HOLLIS-ROCK OUTCROP COMPLEX	B
135	CHATFIELD VARIANT-NEWFIELDS COMPLEX	C
538	SQUAMSCOTT FINE SANDY LOAM	C
656	RIDGEBURY FINE SANDY LOAM	C

SLOPE PHASE:	
0-8%	B
8-15%	C
15-25%	D
25%+	E

SITE DEVELOPMENT PLANS

TAX MAP 256 LOT 2
POST DRAINAGE PLAN
THE VILLAGE AT BANFIELD WOODS
PORTSMOUTH, NH

OWNED BY
WALTER D HETT TRUST
 PREPARED FOR
GREEN & COMPANY REAL ESTATE
1"=60' (11"X17')
SCALE: 1"=30' (22"X34') **SEPTEMBER 25, 2019**

May 06, 2020 - 9:03am F:\MISC Projects\47361 - Portsmouth\47361-00 - Green & Co - Banfield Road\Design\Production Drawings\Pre-Post_Drainage.dwg

Copyright 2019 © Thomas F. Moran, Inc.
 48 Constitution Drive, Bedford, N.H. 03110
 All rights reserved. These plans and materials may not be copied, duplicated, replicated or otherwise reproduced in any form whatsoever without the prior written permission of Thomas F. Moran, Inc.
 This plan is not effective unless signed by a duly authorized officer of Thomas F. Moran, Inc.

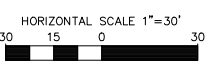

REV	DATE	DESCRIPTION	DR	CK
6	5/5/2020	AoT SUBMITTAL	RCK	JJM
5	4/29/2020	REVISOR PER REGULATORY COMMENTS	RCK	JJM
4	3/20/2020	PROGRESS PRINT	RCK	JJM
3	3/4/2020	UPDATE PLANS PER REGULATORY COMMENTS	RCK	JJM
2	12/27/2019	IN HOUSE REVISIONS	RCK	JJM
1	5/5/2020	AoT SUBMITTAL	RCK	JJM

TFM	Civil Engineers	48 Constitution Drive Bedford, NH 03110 Phone (603) 472-4488 Fax (603) 472-9747 www.tfmoran.com	
	Structural Engineers Traffic Engineers Land Surveyors Landscape Architects Scientists		
FILE 47361.00	DR RCK FB CK JJM CADFILE	- PRE-POST_DRAINAGE	D-04

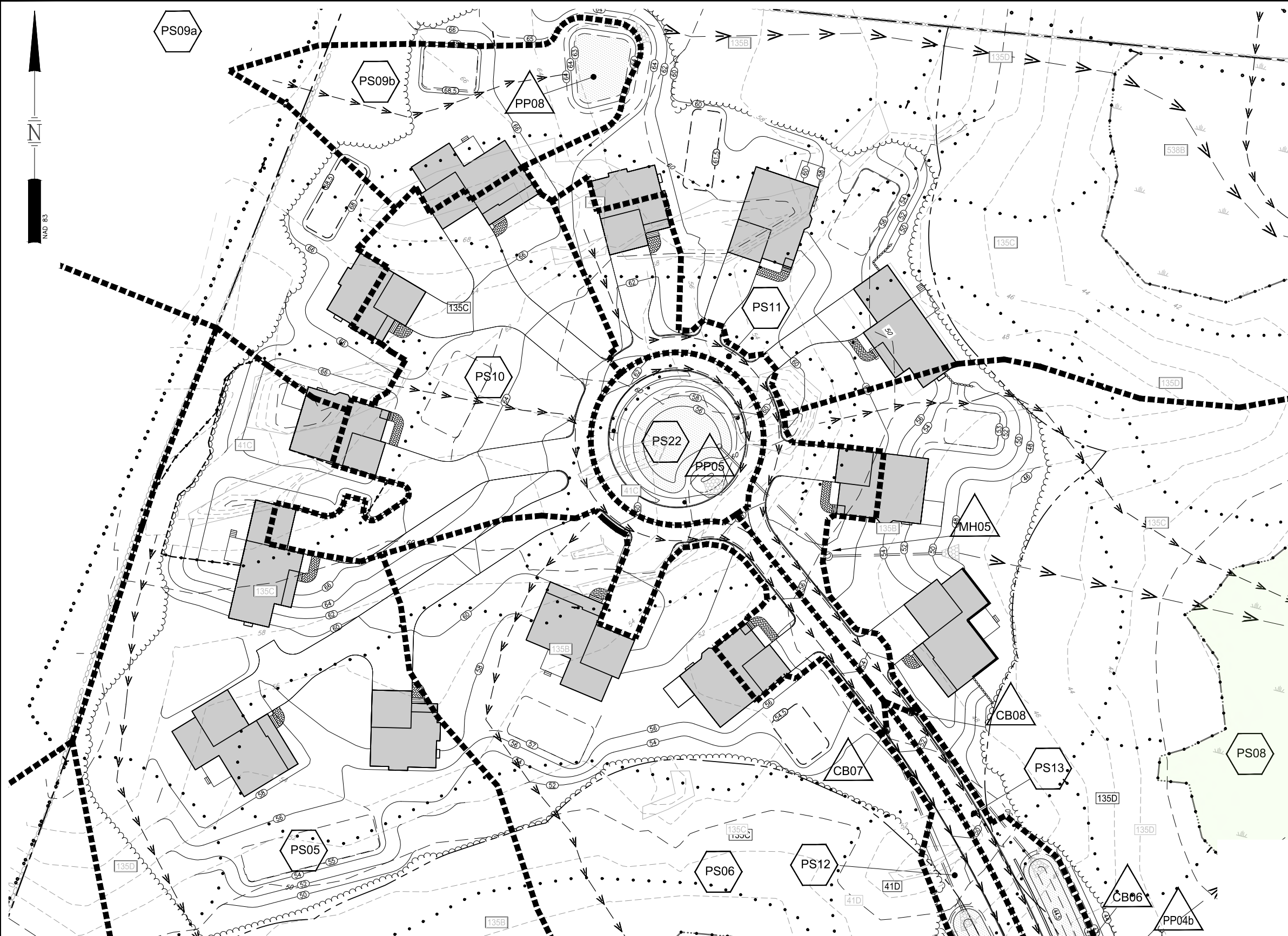

LEGEND

- FLOW PATH (Tc LINE)
- REACH
- SOIL GROUP BREAK LINE
- EXISTING LOT LINE
- LIMITS OF SUBCATCHMENT
- ES4 PROPOSED SUBCATCHMENT NODE
- ER1 PROPOSED REACH
- EC1 PROPOSED POND AREA AND CULVERT NODE
- PPOi3 POINT OF INTEREST

SOIL LEGEND PER USDA NRCS WEB SOIL SURVEY

NRCS SYMBOL	NRCS DESCRIPTION	PERCENT SLOPE	HYDROLOGIC SOIL GROUP
38B	ELDRIDGE FINE SANDY LOAM, - 8% SLOPES	3%	C/D
140B	CHATFIELD-HOLLIS-CANTON COMPLEX, 0% - 8%		B
140C	CHATFIELD-HOLLIS-CANTON COMPLEX, 8% - 15%		B
538A	SQUAMSCOTT FINE SANDY LOAM, 0% - 5%		C/D

SOIL LEGEND PER SITE SPECIFIC SOIL SURVEY (SSS)

SSS SYMBOL	SSS MAP NAME	HYDROLOGIC SOIL GROUP
41	CHATFIELD-HOLLIS-ROCK OUTCROP COMPLEX	B
135	CHATFIELD VARIANT-NEWFIELDS COMPLEX	C
538	SQUAMSCOTT FINE SANDY LOAM	C
656	RIDGEBURY FINE SANDY LOAM	C

SLOPE PHASE:	
0-8%	B
8-15%	C
15-25%	D
25%+	E

SITE DEVELOPMENT PLANS

TAX MAP 256 LOT 2
POST DEVELOPMENT DRAINAGE PLAN
THE VILLAGE AT BANFIELD WOODS
PORTSMOUTH, NH

OWNED BY
WALTER D HETT TRUST
 PREPARED FOR
GREEN & COMPANY REAL ESTATE
1"=60' (11"X17')
SCALE: 1"=30' (22"X34') **SEPTEMBER 25, 2019**

Copyright 2019 © Thomas F. Moran, Inc.
 48 Constitution Drive, Bedford, N.H. 03110

All rights reserved. These plans and materials may not be copied, duplicated, replicated or otherwise reproduced in any form whatsoever without the prior written permission of Thomas F. Moran, Inc.

This plan is not effective unless signed by a duly authorized officer of Thomas F. Moran, Inc.

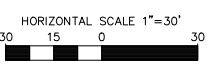

REV	DATE	DESCRIPTION	DR	CK
6	5/5/2020	AoT SUBMITTAL	RCK	JJM
5	4/29/2020	REVISOR PER REGULATORY COMMENTS	RCK	JJM
4	3/20/2020	PROGRESS PRINT	RCK	JJM
3	3/4/2020	UPDATE PLANS PER REGULATORY COMMENTS	RCK	JJM
2	12/27/2019	IN HOUSE REVISIONS	RCK	JJM
1	5/5/2020	AoT SUBMITTAL	RCK	JJM

Civil Engineers
Structural Engineers
Traffic Engineers
Land Surveyors
Landscape Architects
Scientists

48 Constitution Drive
Bedford, NH 03110
Phone (603) 472-4488
Fax (603) 472-9747
www.tfmoran.com

FILE: 47361.00	DR: RCK	FB: -	CK: JJM	CADFILE: PRE-POST_DRAINAGE	D-05
----------------	---------	-------	---------	----------------------------	------

May 06, 2020 - 9:03am F:\MISC Projects\47361 - Portsmouth\47361-00 - Green & Co. - Banfield Road\Design\Production Drawings\Pre-Post_Drainage.dwg

(This Page Is Intentionally Blank)

May 05, 2020 - 5:30pm F:\MISC Projects\47361 - Portsmouth\47361-00 - Green & Co - Banfield Road\Design\Production Drawings\Pre-Post_Drainage.dwg

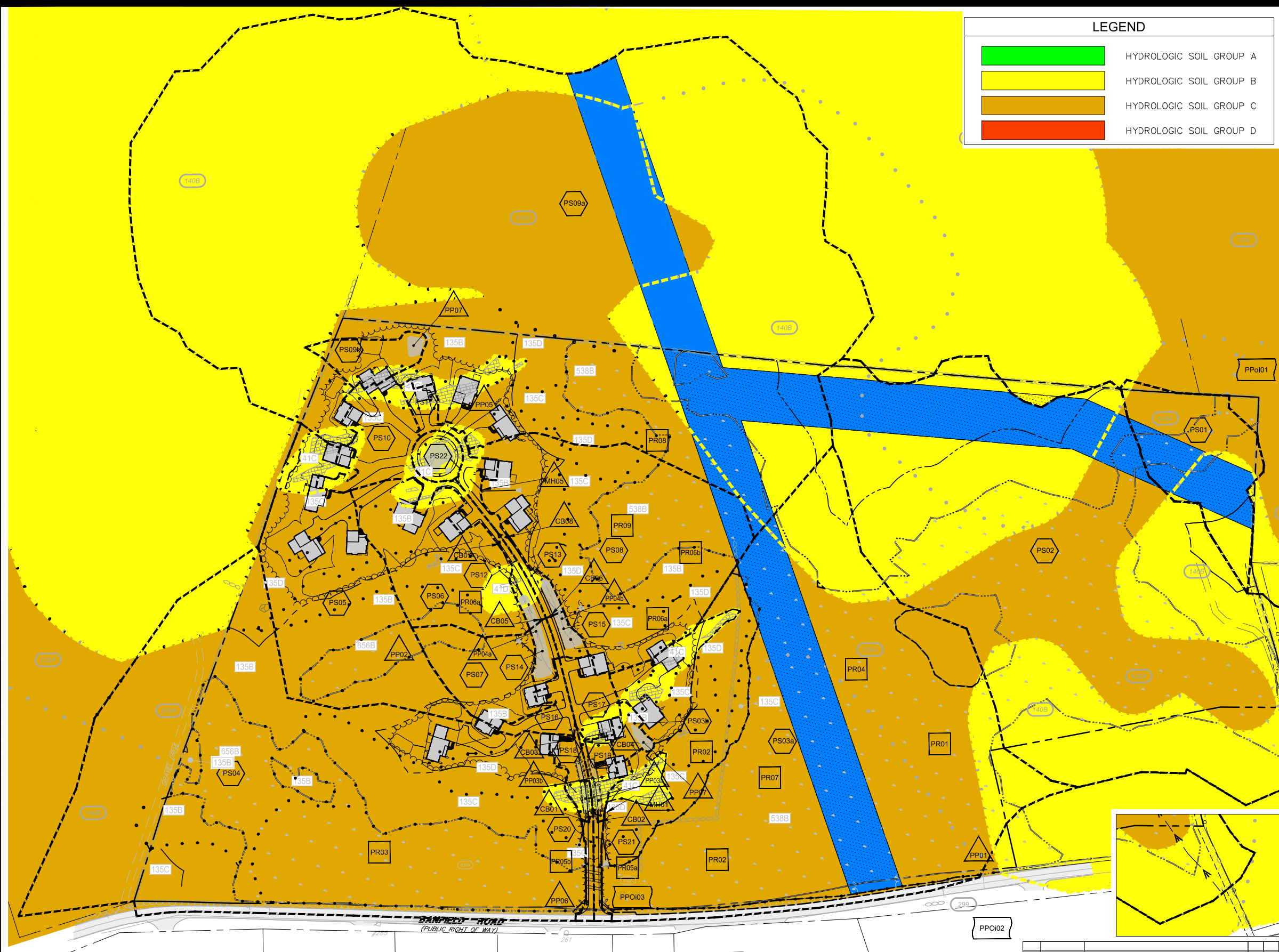

LEGEND	
	HYDROLOGIC SOIL GROUP A
	HYDROLOGIC SOIL GROUP B
	HYDROLOGIC SOIL GROUP C
	HYDROLOGIC SOIL GROUP D

LEGEND	
	FLOW PATH (Tc LINE)
	REACH
	SOIL GROUP BREAK LINE
	EXISTING LOT LINE
	LIMITS OF SUBCATCHMENT
	PROPOSED SUBCATCHMENT NODE
	PROPOSED REACH
	PROPOSED POND AREA AND CULVERT NODE
	POINT OF INTEREST

SOIL LEGEND PER USDA NRCS WEB SOIL SURVEY			
NRCS SYMBOL	NRCS DESCRIPTION		HYDROLOGIC SOIL GROUP
38B	ELDRIDGE FINE SANDY LOAM, 8% SLOPES	3%	C/D
140B	CHATFIELD-HOLLIS-CANTON COMPLEX, 0% - 8%		B
140C	CHATFIELD-HOLLIS-CANTON COMPLEX, 8% - 15%		B
538A	SQUAMSCOTT FINE SANDY LOAM, 0% - 5%		C/D

SOIL LEGEND PER SITE SPECIFIC SOIL SURVEY (SSS)			
SSS SYMBOL	SSS MAP NAME		HYDROLOGIC SOIL GROUP
41	CHATFIELD-HOLLIS-ROCK OUTCROP COMPLEX		B
135	CHATFIELD VARIANT-NEWFIELDS COMPLEX		C
538	SQUAMSCOTT FINE SANDY LOAM		C
656	RIDGEBURY FINE SANDY LOAM		C
SLOPE PHASE:			
0-8%		B	
8-15%		C	
15-25%		D	
25%+		E	

SITE DEVELOPMENT PLANS
TAX MAP 256 LOT 2
HYDROLOGIC SOIL GROUPS
THE VILLAGE AT BANFIELD WOODS
PORTSMOUTH, NH
OWNED BY
WALTER D HETT TRUST
PREPARED FOR
GREEN & COMPANY REAL ESTATE
1"=200' (11"X17")
SCALE: 1"=100' (22"X34') **SEPTEMBER 25, 2019**

Copyright 2019 © Thomas F. Moran, Inc.
48 Constitution Drive, Bedford, N.H. 03110
All rights reserved. These plans and materials may not be copied, duplicated, replicated or otherwise reproduced in any form whatsoever without the prior written permission of Thomas F. Moran, Inc.
This plan is not effective unless signed by a duly authorized officer of Thomas F. Moran, Inc.

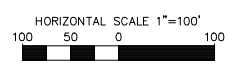

REV	DATE	DESCRIPTION	DR	CK
6	5/5/2020	AoT SUBMITTAL	RCK	JJM
5	4/29/2020	REVISOR PER REGULATORY COMMENTS	RCK	JJM
4	3/20/2020	PROGRESS PRINT	RCK	JJM
3	3/4/2020	UPDATE PLANS PER REGULATORY COMMENTS	RCK	JJM
2	12/27/2019	IN HOUSE REVISIONS	RCK	JJM
1	5/5/2020	AoT SUBMITTAL	RCK	JJM

TFM	Civil Engineers	48 Constitution Drive Bedford, NH 03110 Phone (603) 472-4488 Fax (603) 472-9747 www.tfmoran.com	
	Structural Engineers Traffic Engineers Land Surveyors Landscape Architects Scientists		
FILE 47361.00	DR RCK FB CK JJM CADFILE	PRE-POST_DRAINAGE	D-06

(This Page Is Intentionally Blank)

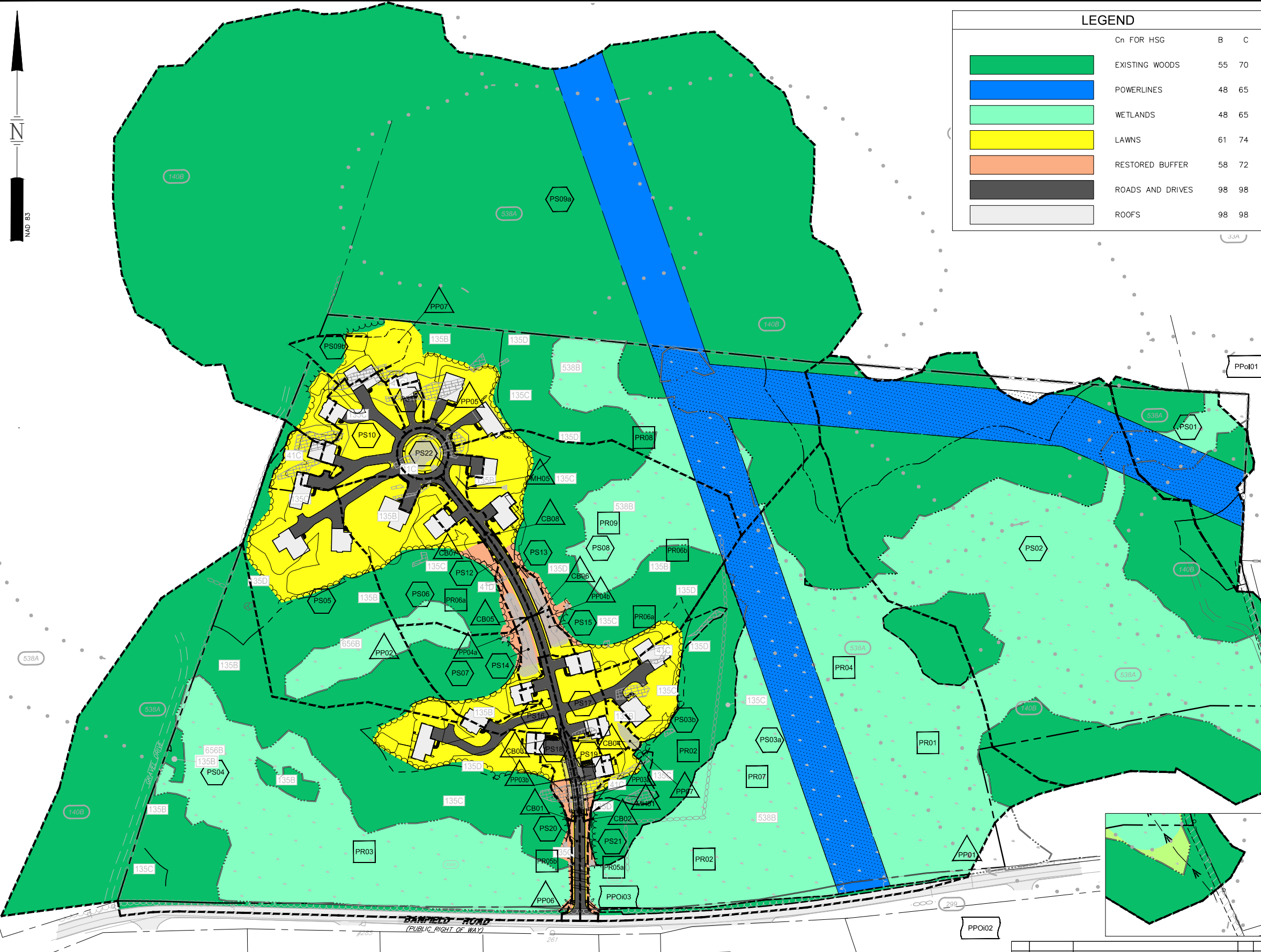

LEGEND				
	Cn	FOR HSG	B	C
	EXISTING WOODS	55	70	
	POWERLINES	48	65	
	WETLANDS	48	65	
	LAWNS	61	74	
	RESTORED BUFFER	58	72	
	ROADS AND DRIVES	98	98	
	ROOFS	98	98	

LEGEND	
	FLOW PATH (Tc LINE)
	REACH
	SOIL GROUP BREAK LINE
	EXISTING LOT LINE
	LIMITS OF SUBCATCHMENT
	PROPOSED SUBCATCHMENT NODE
	PROPOSED REACH
	PROPOSED POND AREA AND CULVERT NODE
	POINT OF INTEREST

SOIL LEGEND PER USDA NRCS WEB SOIL SURVEY		
NRCS SYMBOL	NRCS DESCRIPTION	HYDROLOGIC SOIL GROUP
38B	ELDRIDGE FINE SANDY LOAM, 8% SLOPES	3% C/D
140B	CHATFIELD-HOLLIS-CANTON COMPLEX, 0% - 8%	B
140C	CHATFIELD-HOLLIS-CANTON COMPLEX, 8% - 15%	B
538A	SQUAMSCOTT FINE SANDY LOAM, 0% - 5%	C/D

SOIL LEGEND PER SITE SPECIFIC SOIL SURVEY (SSS)		
SSS SYMBOL	SSS MAP NAME	HYDROLOGIC SOIL GROUP
41	CHATFIELD-HOLLIS-ROCK OUTCROP COMPLEX	B
135	CHATFIELD VARIANT-NEWFIELDS COMPLEX	C
538	SQUAMSCOTT FINE SANDY LOAM	C
656	RIDGEBURY FINE SANDY LOAM	C
SLOPE PHASE:		
0-8%	B	
8-15%	C	
15-25%	D	
25%+	E	

SITE DEVELOPMENT PLANS
 TAX MAP 256 LOT 2
CURVE NUMBER PLAN
THE VILLAGE AT BANFIELD WOODS
PORTSMOUTH, NH
 OWNED BY
WALTER D HETT TRUST
 PREPARED FOR
GREEN & COMPANY REAL ESTATE
1"=200' (11"X17")
SCALE: 1"=100' (22"X34") **SEPTEMBER 25, 2019**

REV	DATE	DESCRIPTION	DR	CK
6	5/5/2020	AoT SUBMITTAL	RCK	JJM
5	4/29/2020	REVISOR PER REGULATORY COMMENTS	RCK	JJM
4	3/20/2020	PROGRESS PRINT	RCK	JJM
3	3/4/2020	UPDATE PLANS PER REGULATORY COMMENTS	RCK	JJM
2	12/27/2019	IN HOUSE REVISIONS	RCK	JJM
1	5/5/2020	AoT SUBMITTAL	RCK	JJM

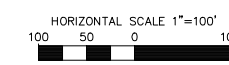

Copyright 2019 © Thomas F. Moran, Inc.
 48 Constitution Drive, Bedford, N.H. 03110
 All rights reserved. These plans and materials may not be copied, duplicated, replicated or otherwise reproduced in any form whatsoever without the prior written permission of Thomas F. Moran, Inc.
 This plan is not effective unless signed by a duly authorized officer of Thomas F. Moran, Inc.

May 05, 2020 - 5:31pm
 F:\MISC Projects\47361 - Portsmouth\47361-00 - Green & Co - Banfield Road\Design\Production Drawings\Pre-Post_Drainage.dwg

	Civil Engineers Structural Engineers Traffic Engineers Land Surveyors Landscape Architects Scientists	48 Constitution Drive Bedford, NH 03110 Phone (603) 472-4488 Fax (603) 472-9747 www.tfmoran.com
	47361.00	DR RCK FB CK JJM CADFILE

D-07

(This Page Is Intentionally Blank)

STORMWATER MANAGEMENT SYSTEM OPERATION & MAINTENANCE MANUAL

F O R

The Village at Banfield Woods

**Portsmouth, New Hampshire
Rockingham County**

Tax Map 256, Lot 2

May 28, 2020

Prepared By:



Civil Engineers
Structural Engineers
Traffic Engineers
Land Surveyors
Landscape Architects
Scientists

(This Page Is Intentionally Blank)

Table of Contents

Maintenance of Property	1
Plans	1
Owner Responsibility	1-2
General Inspection and Maintenance Requirements	2
Inspection and Maintenance Checklist Requirements	3-9
Inspection and Maintenance Records	10
Owner's Certification	11
Attachment 1 – Inspection and Maintenance Log	
Attachment 2 – Deicing Log	
Appendix A – Stormwater Operation & Maintenance Plan	
Appendix B – UNHSC Regular Inspection and Maintenance Guidelines & UNHSC Checklist for Inspection	
Appendix C – Control of Invasive Plants	
Appendix D – R-Tank Operation, Inspection, and Maintenance	
Appendix E – Flexstorm Inlet Filter, Inspection, and Maintenance	
Appendix F – Chloride Management Plan	

(This Page Is Intentionally Blank)

Maintenance of Property

TFMoran, Inc., has prepared the following Stormwater Management System Operation & Maintenance Plan for The Village at Banfield Woods in Portsmouth, New Hampshire. The intent of this plan is to provide the owner, and future property managers/owners of the site with a list of procedures that document the inspection and maintenance requirements of the Stormwater Management System for this development. This includes all temporary and permanent stormwater and erosion control measure during and post construction.

Plans

Refer to the Site Development Plans prepared by MSC a divisions TFMoran, Inc. for Tax Map 256 Lot 2, The Village at Banfield Woods, Portsmouth, New Hampshire, dated September 25, 2019 and last revised on May 5, 2020. See Appendix A for the “Stormwater Operation and Maintenance Plan” identifying locations of stormwater practices described hereon.

Owner Responsibility

The owner shall be responsible for the following inspection and maintenance program which is necessary in order to keep the Stormwater Management System functioning properly. These measures will help to reduce potential environmental impacts. By following the enclosed procedures, Green & Company Real Estate and its successors will be able to maintain the functional design of the Stormwater Management System and maximize its ability to remove sediment and other contaminants from site-generated stormwater runoff.

The owner and future owners are the responsible party for the following record keeping activities further identified in this Operation & Maintenance Manual:

- Conduct reporting, inspection, and maintenance activities in accordance with the “Inspection and Maintenance Checklist Requirements” and if applicable “Regular Inspection and Maintenance Guidance” provided by University of New Hampshire Stormwater Center (UNHSC);
- Document each inspection and maintenance activity with the “Inspection and Maintenance Log” and if applicable “Checklist for Inspection” provided by University of New Hampshire Stormwater Center (UNHSC);
- Photograph each practice that is subject to the “Inspection and Maintenance Checklist Requirements” at each inspection of that stormwater practice;
- Document actions taken if invasive species begin to grow in the stormwater management system; and
- Document each application of deicing material applied to the site with the “Deicing Log” included with the “Chloride Management Plan”

All record keeping required by the Operation & Maintenance Manual shall be maintained by the responsible party and be made available to the applicable regulatory agencies (i.e. NHDES AoT Bureau, City of Portsmouth, etc.) upon request. The property owner shall submit records to the City of Portsmouth yearly. Logs and reports required by this Operation & Maintenance Manual should be prepared by a

qualified inspector with working knowledge of the site. This manual and associated records shall be transferred to any future owners. All current and future owners must comply with RSA 485-A:17, Env-Wq 1500, the permit, and all conditions contained in the permit.

The following inspection and maintenance program is necessary in order to keep the Stormwater Management System functioning properly. These measures will help to reduce potential environmental impacts. By following the enclosed procedures, Green & Company Real Estate and its successors will be able to maintain the functional design of the Stormwater Management System and maximize its ability to remove sediment and other contaminants from site-generated stormwater runoff.

General Inspection and Maintenance Requirements

Temporary stormwater, sediment and erosion control measures that require maintenance on the site during construction include, but are not limited, to the following:

- Stabilized construction entrance;
- Silt sock barriers;
- Inlet protection; and
- Construction dumpster area, if used.

Permanent stormwater, sediment and erosion control measures that require maintenance on the site include, but are not limited, to the following:

- Litter/trash removal;
- Dumpster area maintenance;
- Pavement sweeping;
- Surface maintenance related to deicing/plowing;
- Rip-rap protection;
- Treatment swales;
- Grass swales;
- Bioretention systems;
- Forebays;
- Outlet control structures;
- Emergency overflow area;
- Infiltration basins;
- Catch basins, drop inlets, and/or drain manholes;
- Subsurface storage structures; and
- Culvert pipes.
- Ecopassages
- Conservation Mix Area (Over Utilities)
- Pretx

Inspection and Maintenance Checklist Requirements

By implementing the following procedures, current owners will be able to maintain the functional design of the Stormwater Management System and maximize the system's ability to remove sediment and other contaminants from site-generated stormwater runoff. The owner shall conduct inspection and maintenance activities in accordance with the following checklist:

	<i>Frequency</i>	<i>Inspect</i>	<i>Action</i>
<i>Temporary Controls</i>			
Stabilized Construction Entrance	Weekly	<ul style="list-style-type: none"> • Inspect adjacent roadway for sediment tracking • Inspect stone for sediment accumulation 	<ul style="list-style-type: none"> • Sweep adjacent roadways as soon as sediment is tracked • Top dress with additional stone when necessary to prevent tracking
Litter/Trash Removal	Routinely	<ul style="list-style-type: none"> • Inspect site especially construction areas 	<ul style="list-style-type: none"> • Remove debris and clean areas as necessary
Construction Dumpster Area Maintenance (if used)	Routinely	<ul style="list-style-type: none"> • Dumpster Areas 	<ul style="list-style-type: none"> • Remove any accumulated debris and dispose of properly
Silt Sock Barrier	Weekly	<ul style="list-style-type: none"> • Inspect accumulated sediment level, rips and tears 	<ul style="list-style-type: none"> • Repair or replace damaged lengths • Remove and dispose accumulated sediment once level reaches 1/3 of barrier
Gravel	Spring and Fall	<ul style="list-style-type: none"> • Inspect gravel for ruts and depth 	<ul style="list-style-type: none"> • Replace gravel as necessary, regrade as necessary to maintain design grades, remove any accumulated gravel washed from roadway

	<i>Frequency</i>	<i>Inspect</i>	<i>Action</i>
<i>Permanent Controls</i>			
Rip Rap Outlet Protection	Spring and Fall and after rainstorms exceeding 2.5 inches in 24 hrs	<ul style="list-style-type: none"> • Inspect for damage or displaced stones • Inspect for torn or visible fabric 	<ul style="list-style-type: none"> • Repair and replace stone and / or fabric immediately • Remove accumulated sediment, trash and blocking materials

	Frequency	Inspect	Action
Permanent Controls			
Treatment Swale	Annually	<ul style="list-style-type: none"> • Inspect for erosion, sediment accumulation, vegetation loss, and presence of invasive species 	<ul style="list-style-type: none"> • Remove debris and accumulated sediment (sediment accumulation should not exceed 3") • Repair eroded areas • Remove invasive species and dead vegetation • Reseed as warranted
	Spring and Fall	<ul style="list-style-type: none"> • Inspect height of vegetation 	<ul style="list-style-type: none"> • Mow when necessary—allow length of vegetation to remain at least 4"
Stone Check Dam	Spring and Fall after rainstorms exceeding 2.5 inches in 24 hrs	<ul style="list-style-type: none"> • Inspect for sediment accumulation, permeability of stone, damaged or displaced stone • Inspect for standing water 	<ul style="list-style-type: none"> • Repair and replace stone immediately • Remove accumulated sediment, trash and blocking materials • Regrade as necessary
Infiltration Basin	Spring and Fall and after rainstorms exceeding 2.5 inches in 24 hrs	<ul style="list-style-type: none"> • Inspect level of accumulated sediment • Inspect for debris • Inspect outlet structures • Inspect vegetative cover • Inspect embankments and spillways • Inspect infiltration function within 72-hrs following a rainfall event 	<ul style="list-style-type: none"> • Remove accumulated sediment • Remove debris from inlet and outlets • Repair as necessary • Mow embankments and removed woody vegetation • Repair embankments and spillways as necessary • Restore infiltration by removing accumulated sediments and reconstruction of the infiltration basin if deemed necessary

	Frequency	Inspect	Action
Permanent Controls			
Landscape (not including Bioretention Systems)	Spring	<ul style="list-style-type: none"> • Mulch: Inspect mulch areas for trash and debris and thickness of mulch 	<ul style="list-style-type: none"> • Remove weeds and debris. Top dress with new mulch when necessary
	Spring	<ul style="list-style-type: none"> • Trees and Shrubs: Inspect for broken, weak or diseased branches and debris 	<ul style="list-style-type: none"> • Prune to maintain shape to avoid splitting, remove broken, weak or diseased branches, replace as necessary
	As necessary	<ul style="list-style-type: none"> • Lawn 	<ul style="list-style-type: none"> • Mow as required
	Spring and Fall	<ul style="list-style-type: none"> • Inspect landscaped areas for debris and litter 	<ul style="list-style-type: none"> • Remove debris and litter as necessary
Bioretention System	1st few months when rainfall exceeds 2.5" in a 24 hr period	<ul style="list-style-type: none"> • Inspect drawdown time: required to drawdown in 72 hrs or the standing water covers more than 15% of the surface after 48 hrs 	<ul style="list-style-type: none"> • Remove the top few inches of discolored material and rake or till the remaining material as needed
	4 times for 1 st yr, then Spring and Fall	<ul style="list-style-type: none"> • Inspect for animal burrows and short circuits in the system • Inspect inlet and outlet for debris and leaves • Inspect the filter bed • Inspect vegetation for distress during extended periods without rain 	<ul style="list-style-type: none"> • Repair soil erosion from and fill holes and lightly compact • Remove material with rakes where possible rather than heavy construction equipment to avoid compaction of the gravel wetland surface • Remove sediment as necessary. If more than 2" of filter material is removed, replace with the design filter media specified • Water as necessary

	Frequency	Inspect	Action
Permanent Controls			
	Spring and Fall	<ul style="list-style-type: none"> Inspect Drawdown time: required to drawdown in 72 hrs or the standing water covers more than 15% of the surface after 48 hrs 	<ul style="list-style-type: none"> Remove the top few inches of discolored material and rake or till the remaining material as needed
	Annually	<ul style="list-style-type: none"> Inspect inlet and outlet for erosion Inspect vegetative cover 	<ul style="list-style-type: none"> Repair or replace as necessary Reinforcement plantings should be performed if 50% cover is not established in 2 yrs.
Additionally, refer to the most currently available documents from UNHSC (attached for reference): "Regular Inspection Maintenance Guidance" and "Checklist for Inspection". If there are discrepancies between the UNHSC documents and this Manual's checklist requirements, the stricter requirements shall override.			
Conventional Pavement	Spring and Fall	<ul style="list-style-type: none"> Inspect pavement for debris 	<ul style="list-style-type: none"> Sweeping as required
Forebay	Annually	<ul style="list-style-type: none"> Inspect for debris and accumulated sediment Inspect for damage or displaced stones 	<ul style="list-style-type: none"> Remove debris and accumulated sediment as necessary Repair and replace stones as needed
Drainage (Catch Basins / Drop Inlets)	Spring and Fall	<ul style="list-style-type: none"> Inspect for sediment Inspect for hydrocarbons Inspect Hoods 	<ul style="list-style-type: none"> If sump is more than half full of sediment, remove sediment as necessary Remove and dispose of properly Repair and replace as necessary
R-Tank Stormwater Detention Systems®	Refer to the most currently available documents from ACF Environmental (attached for reference): "R-Tank Operation, Inspection, and Maintenance". If there are discrepancies between the ACF documents and this Manual's checklist requirements, the stricter requirements shall override.		
R-Tank Pretreatment Flexstorm Inlet Filters	Refer to the most currently available documents from ADS (attached for reference): "Flexstorm Inlet Filter, Inspection and Maintenance Guidelines" and this Manual's checklist requirements, the stricter requirements shall override.		

	Frequency	Inspect	Action
Permanent Controls			
R-Tank Underdrain Systems	When R-Tanks are Flushed	<ul style="list-style-type: none"> • System to be flushed when R-Tanks are flushed 	<ul style="list-style-type: none"> • Remove Orifice Plate from Manhole • Plug Outlet of Drain Manhole • Pump water into flushing ports as rapidly as possible without overtopping system • Pump Outlet Manhole • Run for a minimum of 15 minutes or until flow is clear • Sediment-laden water to be captured and filtered through a Dirtback™ • Remove sediment from structure
Drain Manholes and Yard Drains	Spring and Fall	<ul style="list-style-type: none"> • Inspect for accumulated sediment and debris 	<ul style="list-style-type: none"> • Clean any material upon inspection and deposit of properly
Inlet Protection (temporary during construction)	During construction and after measurable rainfall	<ul style="list-style-type: none"> • Inspect for accumulated sediment 	<ul style="list-style-type: none"> • Empty sediment bag if more than ½ filled with sediment or debris. Replace bag if torn or punctured to ½" diameter or greater on the lower half of the bag
Culvert Pipe	Spring and Fall	<ul style="list-style-type: none"> • Inspect for obstructions 	<ul style="list-style-type: none"> • Remove and dispose of debris properly, Remove upstream debris to prevent future clogging • Repair/replace if pipe becomes crushed or deteriorated

Ecopassages	Spring and Fall	<ul style="list-style-type: none"> Inspect for obstructions 	<ul style="list-style-type: none"> Remove and dispose of debris properly, Remove upstream debris to prevent future clogging Repair/replace if grate or walls deteriorated
	Every 5 years	<ul style="list-style-type: none"> For compliance with H2O loading 	<ul style="list-style-type: none"> A report shall be submitted to the City by a registered NH Professional Engineer
Stone Berm Level Spreader	Annually	<ul style="list-style-type: none"> Inspect for sediment accumulation, debris or signs of erosion 	<ul style="list-style-type: none"> Remove debris Remove sediment when accumulation exceeds 25% of spreader channel depth Mow annually at a min. Repair erosion and regrade or replace stone berm material
Emergency Spillway	Spring and Fall	<ul style="list-style-type: none"> Inspect for erosion, sediment accumulation, stone loss, and presence of invasive species 	<ul style="list-style-type: none"> Remove debris and accumulated sediment (sediment accumulation should not exceed 3") Repair eroded areas Remove invasive species and vegetation Replace stone as necessary
Emergency Overflow	Spring and Fall	<ul style="list-style-type: none"> Inspect for erosion, sediment accumulation, stone loss, and presence of invasive species 	<ul style="list-style-type: none"> Remove debris and accumulated sediment (sediment accumulation should not exceed 3") Repair eroded areas Remove invasive species and vegetation Replace stone as necessary

Grass Swale	Annually	<ul style="list-style-type: none"> • Inspect for erosion, sediment, buildup and presence of invasive species. 	<ul style="list-style-type: none"> • Periodic mowing required • Remove debris and accumulated sediment, based on inspection • Repair eroded areas, remove invasive species and dead vegetation and reseed with applicable grass mix
Conservation Mix Area (Over Utilities)	Late Fall	<ul style="list-style-type: none"> • Inspect vegetative cover 	<ul style="list-style-type: none"> • Mow embankments and removed woody vegetation
Outlet Control Structure	Annually	<ul style="list-style-type: none"> • Inspection for debris or sediment buildup • Inspect structure 	<ul style="list-style-type: none"> • Remove sediment and debris as necessary • Remove debris covering orifice or v-notch • Repair as necessary
Pretx	Annually	<ul style="list-style-type: none"> • Inspection for debris or sediment buildup • Inspect structure 	<ul style="list-style-type: none"> • Remove sediment and debris as necessary • Remove debris covering orifice or v-notch • Repair as necessary

Inspection and Maintenance Records

A detailed, written record of all logs, reports, photographs required by this Operation & Maintenance Manual must be kept by the owner. The property owner shall submit records to the City of Portsmouth yearly.

The attached forms are provided to assist the property manager with the inspection and maintenance of the Stormwater Management System. The “Inspection and Maintenance Log” (Attachment 1) and “Deicing Log” (Attachment 2) on the following pages are blank copies to aid in record keeping required by this Operation & Maintenance Manual.

Supplement the “Inspection and Maintenance Log” with the most currently available “Checklist for Inspections” from UNHSC (attached to this Manual for reference) and “R-Tank Operation, Inspection, and Maintenance”. Each inspection or maintenance activity shall include photographs of each practice that is subject to the “Inspection and Maintenance Checklist Requirements” at each inspection of that stormwater practice. Log actions taken if invasive species begin to grow in the stormwater management system as required per the attached “Control of Invasive Plants”.

For all surface maintenance related activities related to deicing/plowing, complete the “Deicing Log” to track the amount and type of deicing materials applied to the site. Snow shall be stored in designated snow storage areas which have been designed to drain on-site and receive treatment via the stormwater management system prior to infiltration or discharge. The subject property is subject to chloride impairment; maintenance related to snow and ice shall adhere to the Chloride Management Plan (attached to this Manual for reference).

Owner's Certification

Contact Information

Owner: Green & Company Real Estate
Contact Person: Rick Green
11 Lafayette Road, North Hampton, NH 03868
603-964-7572

I have reviewed this document and understand the responsibilities contained. I agree to perform the required maintenance on the stormwater management system.

Owner's Signature (future owner's and successors, if applicable)

Print Name

Title

Date

Any inquiries in regard to the design, function, and/or maintenance of any one of the above mentioned facilities or tasks shall be directed to the project engineer:

MSC a division of TFMoran, Inc.
170 Commerce Way, Suite 102
Portsmouth, NH 03801
(603) 431-2222

(This Page Is Intentionally Blank)

ATTACHMENT 1

Inspection and Maintenance Log

(This Page Is Intentionally Blank)

(This Page Is Intentionally Blank)

ATTACHMENT 2

Deicing Log

(This Page Is Intentionally Blank)

(This Page Is Intentionally Blank)

APPENDIX A

Stormwater Operation & Maintenance Plan

(This Page Is Intentionally Blank)

May 12, 2020 - 9:02am
 F:\MISC Projects\47361 - Portsmouth\47361-00 - Green & Co - Banfield Road\Design\Production Drawings\EXHIBIT\47361-00_Stormwater-Plan.dwg

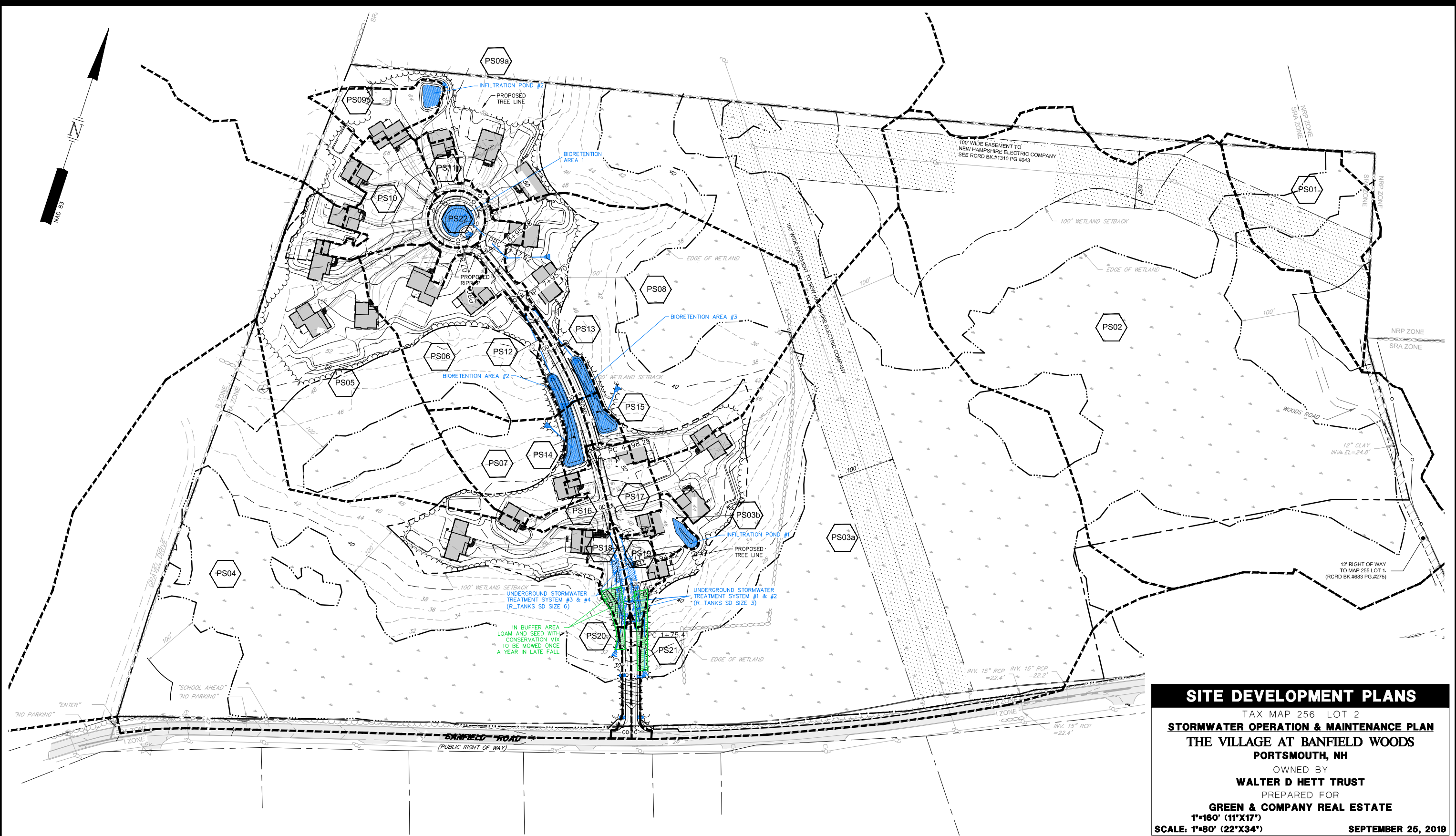

SITE DEVELOPMENT PLANS
 TAX MAP 256 LOT 2
STORMWATER OPERATION & MAINTENANCE PLAN
THE VILLAGE AT BANFIELD WOODS
PORTSMOUTH, NH
 OWNED BY
WALTER D HETT TRUST
 PREPARED FOR
GREEN & COMPANY REAL ESTATE
1"=160' (11"X17")
SCALE: 1"=80' (22"X34') **SEPTEMBER 25, 2019**

Copyright 2019 © Thomas F. Moran, Inc.
 48 Constitution Drive, Bedford, N.H. 03110
 All rights reserved. These plans and materials may not be copied, duplicated, replicated or otherwise reproduced in any form whatsoever without the prior written permission of Thomas F. Moran, Inc.
 This plan is not effective unless signed by a duly authorized officer of Thomas F. Moran, Inc.

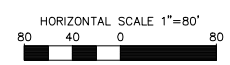

REV.	DATE	DESCRIPTION	DR	CK
6	5/5/2020	AoT SUBMITTAL	RCK	JJM
5	4/29/2020	REVISOR PER REGULATORY COMMENTS	RCK	JJM
4	3/20/2020	PROGRESS PRINT	RCK	JJM
3	3/4/2020	UPDATE PLANS PER REGULATORY COMMENTS	RCK	JJM
2	12/27/2019	IN HOUSE REVISIONS	RCK	JJM
1	12/23/19	REVISED PER REGULATORY COMMENTS	RCK	JJM

TFM	Civil Engineers Structural Engineers Traffic Engineers Land Surveyors Landscape Architects Scientists			48 Constitution Drive Bedford, NH 03110 Phone (603) 472-4488 Fax (603) 472-9747 www.tfmoran.com		
	DR	RCK	FB			
FILE	47361.00	CK	JJM	CADFILE	47361-00_STORMWATER-PLAN	O&M-1

May 12, 2020 - 9:02am
 F:\MISC Projects\47361 - Portsmouth\47361-00 - Green & Co - Banfield Road\Design\Production Drawings\EXHIBIT\47361-00_Stormwater-Plan.dwg

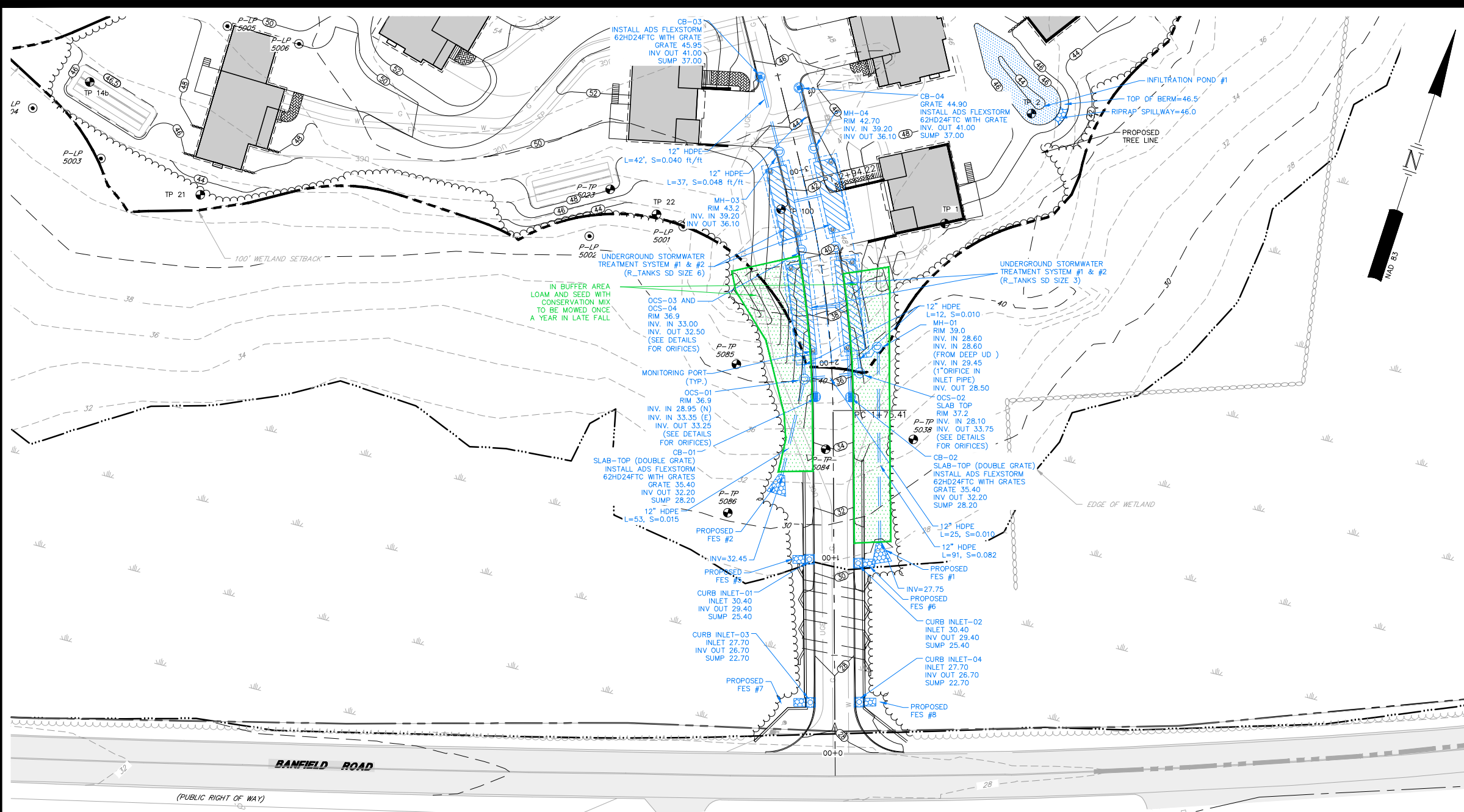

SITE DEVELOPMENT PLANS
 TAX MAP 256 LOT 2
STORMWATER OPERATION & MAINTENANCE PLAN
THE VILLAGE AT BANFIELD WOODS
PORTSMOUTH, NH
 OWNED BY
WALTER D HETT TRUST
 PREPARED FOR
GREEN & COMPANY REAL ESTATE
1"=60' (11'X17")
SCALE: 1"=30' (22'X34') **SEPTEMBER 25, 2019**

Copyright 2019 © Thomas F. Moran, Inc.
 48 Constitution Drive, Bedford, N.H. 03110
 All rights reserved. These plans and materials may not be copied, duplicated, replicated or otherwise reproduced in any form whatsoever without the prior written permission of Thomas F. Moran, Inc.
 This plan is not effective unless signed by a duly authorized officer of Thomas F. Moran, Inc.

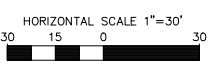

REV.	DATE	DESCRIPTION	DR	CK
6	5/5/2020	AoT SUBMITTAL	RCK	JJM
5	4/29/2020	REVISOR PER REGULATORY COMMENTS	RCK	JJM
4	3/20/2020	PROGRESS PRINT	RCK	JJM
3	3/4/2020	UPDATE PLANS PER REGULATORY COMMENTS	RCK	JJM
2	12/27/2019	IN HOUSE REVISIONS	RCK	JJM
1	12/23/19	REVISED PER REGULATORY COMMENTS	RCK	JJM

TFM	Civil Engineers	48 Constitution Drive
	Structural Engineers	Bedford, NH 03110
	Traffic Engineers	Phone (603) 472-4488
	Land Surveyors	Fax (603) 472-9747
	Landscape Architects	www.tfmoran.com
	Scientists	

FILE	47361.00	DR	RCK	FB	-
		CK	JJM	CADFILE	47361-00_STORMWATER-PLAN
					O&M-2

May 12, 2020 - 9:03am
 F:\MISC Projects\47361 - Portsmouth\47361-00 - Green & Co - Bartfield Road\Design\Production Drawings\EXHIBIT\47361-00_Stormwater-Plan.dwg

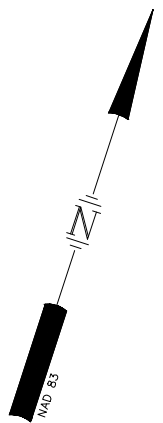
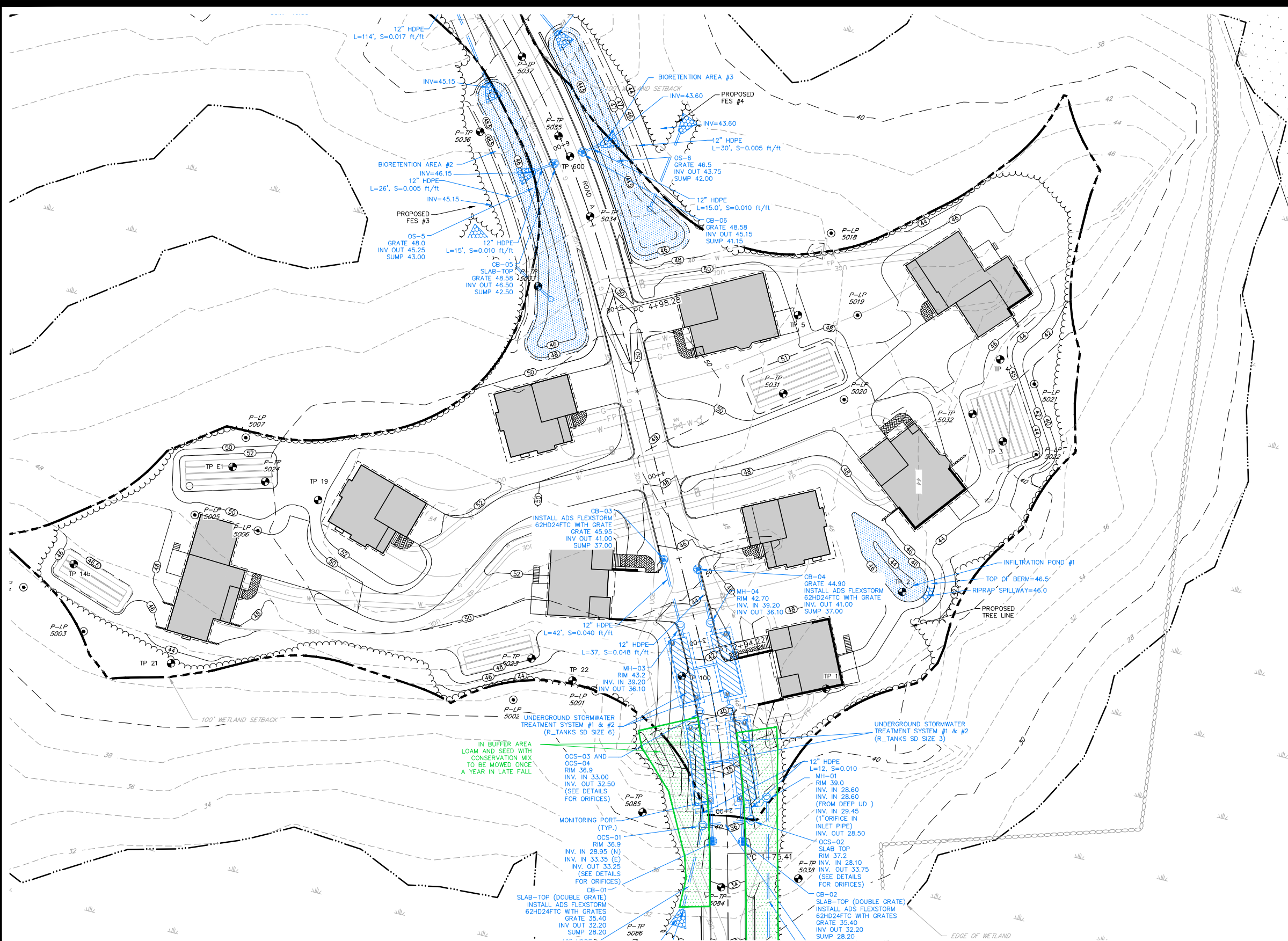

SITE DEVELOPMENT PLANS
 TAX MAP 256 LOT 2
STORMWATER OPERATION & MAINTENANCE PLAN
THE VILLAGE AT BANFIELD WOODS
PORTSMOUTH, NH
 OWNED BY
WALTER D HETT TRUST
 PREPARED FOR
GREEN & COMPANY REAL ESTATE
1"=60' (11'X17')
SCALE: 1"=30' (22'X34') **SEPTEMBER 25, 2019**

Copyright 2019 © Thomas F. Moran, Inc.
 48 Constitution Drive, Bedford, N.H. 03110
 All rights reserved. These plans and materials may not be copied, duplicated, replicated or otherwise reproduced in any form whatsoever without the prior written permission of Thomas F. Moran, Inc.
 This plan is not effective unless signed by a duly authorized officer of Thomas F. Moran, Inc.

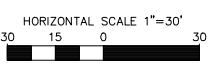

REV.	DATE	DESCRIPTION	DR	CK
6	5/5/2020	AoT SUBMITTAL	RCK	JJM
5	4/29/2020	REVISOR PER REGULATORY COMMENTS	RCK	JJM
4	3/20/2020	PROGRESS PRINT	RCK	JJM
3	3/4/2020	UPDATE PLANS PER REGULATORY COMMENTS	RCK	JJM
2	12/27/2019	IN HOUSE REVISIONS	RCK	JJM
1	12/23/19	REVISED PER REGULATORY COMMENTS	RCK	JJM

TFM	Civil Engineers	48 Constitution Drive
	Structural Engineers	Bedford, NH 03110
	Traffic Engineers	Phone (603) 472-4488
	Land Surveyors	Fax (603) 472-9747
	Landscape Architects	www.tfmoran.com
	Scientists	

47361.00	DR RCK	FB		
	CK JJM	CADFILE	47361-00_STORMWATER-PLAN	O&M-3

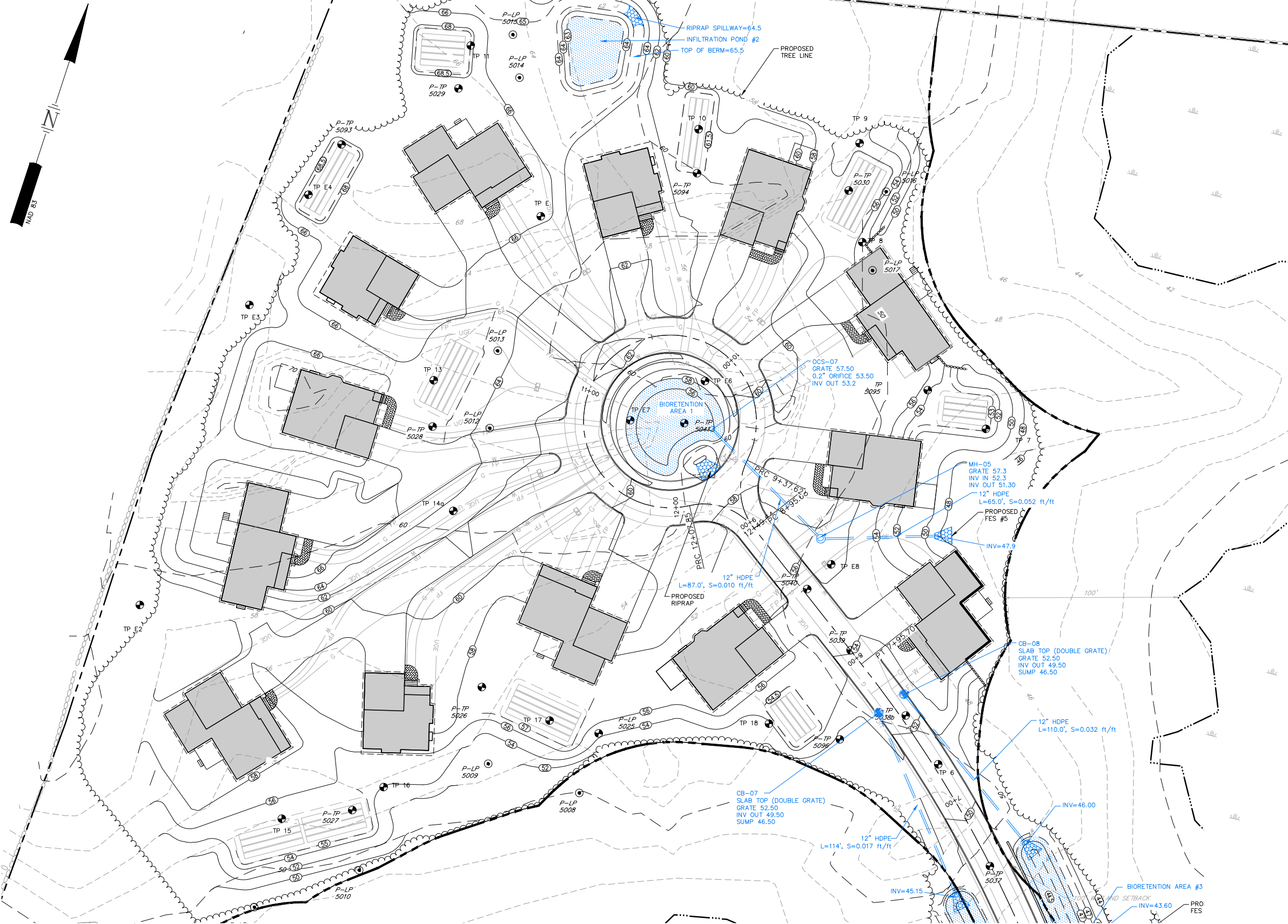

Copyright 2019 © Thomas F. Moran, Inc.
 48 Constitution Drive, Bedford, N.H. 03110
 All rights reserved. These plans and materials may not be copied, duplicated, replicated or otherwise reproduced in any form whatsoever without the prior written permission of Thomas F. Moran, Inc.
 This plan is not effective unless signed by a duly authorized officer of Thomas F. Moran, Inc.

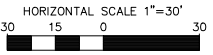

REV.	DATE	DESCRIPTION	DR	CK
6	5/5/2020	AoT SUBMITTAL	RCK	JJM
5	4/29/2020	REVISOR PER REGULATORY COMMENTS	RCK	JJM
4	3/20/2020	PROGRESS PRINT	RCK	JJM
3	3/4/2020	UPDATE PLANS PER REGULATORY COMMENTS	RCK	JJM
2	12/27/2019	IN HOUSE REVISIONS	RCK	JJM
1	12/23/19	REVISED PER REGULATORY COMMENTS	RCK	JJM

SITE DEVELOPMENT PLANS
 TAX MAP 256 LOT 2
STORMWATER OPERATION & MAINTENANCE PLAN
THE VILLAGE AT BANFIELD WOODS
PORTSMOUTH, NH
 OWNED BY
WALTER D HETT TRUST
 PREPARED FOR
GREEN & COMPANY REAL ESTATE
1"=60' (11"X17")
SCALE: 1"=30' (22"X34") **SEPTEMBER 25, 2019**

TFM	Civil Engineers	48 Constitution Drive
	Structural Engineers	Bedford, NH 03110
	Traffic Engineers	Phone (603) 472-4488
	Land Surveyors	Fax (603) 472-9747
	Landscape Architects	www.tfmoran.com
	Scientists	

FILE	47361.00	DR	RCK	FB		
		CK	JJM	CADFILE	47361-00_STORMWATER-PLAN	O&M-4

May 12, 2020 - 9:03am
 F:\MISC Projects\47361 - Portsmouth\47361-00 - Green & Co - Banfield Road\Design\Production Drawings\EXHIBIT\47361-00 Stormwater-Plan.dwg

APPENDIX B

UNHSC Regular Inspection and Maintenance Guidelines &

UNHSC Checklist for Inspection

(This Page Is Intentionally Blank)

Regular Inspection and Maintenance Guidance for Bioretention Systems / Tree Filters

Maintenance of bioretention systems and tree filters can typically be performed as part of standard landscaping. Regular inspection and maintenance is critical to the effective operation of bioretention systems and tree filters to insure they remain clear of leaves and debris and free draining. This page provides guidance on maintenance activities that are typically required for these systems, along with the suggested frequency for each activity. Individual systems may have more, or less frequent maintenance needs depending on a variety of factors including but not limited to: the occurrence of large storm events, overly wet or dry periods, regional hydrologic conditions, and the upstream land use.

ACTIVITIES

The most common maintenance activity is the removal of sediment and organic debris from the system and bypass structures. Visual inspections are routine for system maintenance. This includes looking for standing water, accumulated leaves, holes in the soil media, signs of plant distress, and debris and sediment accumulation in the system. Vegetation coverage is integral to the performance of the system, including infiltration rate and nutrient uptake. Vegetation care is important to system productivity and health.

ACTIVITY

FREQUENCY

CLOGGING AND SYSTEM PERFORMANCE

A record should be kept of the time to drain for the system completely after a storm event. The system should drain completely within 72 hours.

Check to insure the filter surface remains well draining after storm events.

Remedy: If filter bed is clogged, draining poorly, or standing water covers more than 50% of the surface 48 hours after a precipitation event, then remove top few inches of discolored material. Till, or rake remaining material as needed.

After every major storm in the first few months, then annually at minimum.

Check inlets and outlets for leaves and debris.

Remedy: Rake in and around the system to clear it of debris. Also, clear the inlet and overflow if obstructed.

Check for animal burrows and short-circuiting in the system.

Remedy: Soil erosion from short circuiting or animal borroughs should be repaired when they occur. The holes should be filled and lightly compacted

Inspect inlets and outlets to ensure good condition and no evidence of deterioration. Check to see if high-flow bypass is functioning.

Remedy: Repair or replace any damaged structural parts, inlets, outlets, sidewalls.

Quarterly initially, annually as a minimum thereafter.

VEGETATION

Check for robust vegetation coverage throughout the system and dead or dying plants.

Remedy: Vegetation should cover > 75% of the system and should be cared for as needed.

Annually or as needed

(This Page Is Intentionally Blank)

CHECKLIST FOR INSPECTION OF BIORETENTION SYSTEM / TREE FILTERS

Location:
 Inspector:
 Date:
 Time:
 Site Conditions:
 Days Since Last Rain Event:

Inspection Items	Satisfactory (S) or Unsatisfactory (U)	Comments/Corrective Action
1. Initial Inspection After Planting		
Plants are stable, roots not exposed	S U	
Surface is at design level, no evidence of preferential flow/shoving	S U	
Inlet and outlet/bypass are functional	S U	
2. Debris Cleanup (1 time/year minimum, Spring/Fall)		
Litter, leaves, and dead vegetation removed from the system	S U	
Prune/mow vegetation	S U	
3. Standing Water (1 time/year and/or after large storm events)		
No evidence of standing water after 24-48 hours since rainfall	S U	
4. Vegetation Condition and Coverage		
Vegetation condition good with good coverage (typically > 75%)	S U	
5. Other Issues		
Note any additional issues not previously covered.	S U	
Corrective Action Needed		Due Date
1.		
2.		
3.		
Inspector Signature		Date

(This Page Is Intentionally Blank)

APPENDIX C

Control of Invasive Plants

(This Page Is Intentionally Blank)

CONTROL OF INVASIVE PLANTS

During maintenance activities, check for the presence of invasive plants and remove in a safe manner as described on the following pages. They should be controlled as described on the following pages.

Background:

Invasive plants are introduced, alien, or non-native plants, which have been moved by people from their native habitat to a new area. Some exotic plants are imported for human use such as landscaping, erosion control, or food crops. They also can arrive as "hitchhikers" among shipments of other plants, seeds, packing materials, or fresh produce. Some exotic plants become invasive and cause harm by:

- becoming weedy and overgrown;
- killing established shade trees;
- obstructing pipes and drainage systems;
- forming dense beds in water;
- lowering water levels in lakes, streams, and wetlands;
- destroying natural communities;
- promoting erosion on stream banks and hillsides; and
- resisting control except by hazardous chemical.

Methods for Disposing Non-Native Invasive Plants

Prepared by the Invasives Species Outreach Group, volunteers interested in helping people control invasive plants. Assistance provided by the Piscataquog Land Conservancy and the NH Invasives Species Committee. Edited by Karen Bennett, Extension Forestry Professor and Specialist.

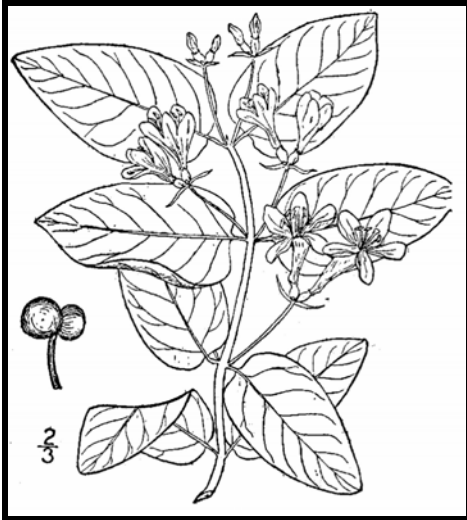

Tatarian honeysuckle

Lonicera tatarica

USDA-NRCS PLANTS Database / Britton, N.L., and A. Brown. 1913. *An illustrated flora of the northern United States, Canada and the British Possessions*. Vol. 3: 282.

Non-native invasive plants crowd out natives in natural and managed landscapes. They cost taxpayers billions of dollars each year from lost agricultural and forest crops, decreased biodiversity, impacts to natural resources and the environment, and the cost to control and eradicate them.

Invasive plants grow well even in less than desirable conditions such as sandy soils along roadsides, shaded wooded areas, and in wetlands. In ideal conditions, they grow and spread even faster. There are many ways to remove these non-native invasives, but once removed, care is needed to dispose the removed plant material so the plants don't grow where disposed.

Knowing how a particular plant reproduces indicates its method of spread and helps determine the appropriate disposal method. Most are spread by seed and are dispersed by wind, water, animals, or people. Some reproduce by vegetative means from pieces of stems or roots forming new plants. Others spread through both seed and vegetative means.

Because movement and disposal of viable plant parts is restricted (see NH Regulations), viable invasive parts can't be brought to most transfer stations in the state. Check with your transfer station to see if there is an approved, designated area for invasives disposal. This fact sheet gives recommendations for rendering plant parts non-viable.

Control of invasives is beyond the scope of this fact sheet. For information about control visit www.nhinvasives.org or contact your UNH Cooperative Extension office.

New Hampshire Regulations

Prohibited invasive species shall only be disposed of in a manner that renders them nonliving and nonviable. (Agr. 3802.04)

No person shall collect, transport, import, export, move, buy, sell, distribute, propagate or transplant any living and viable portion of any plant species, which includes all of their cultivars and varieties, listed in Table 3800.1 of the New Hampshire prohibited invasive species list. (Agr. 3802.01)

How and When to Dispose of Invasives?

To prevent seed from spreading remove invasive plants before seeds are set (produced). Some plants continue to grow, flower and set seed even after pulling or cutting. Seeds can remain viable in the ground for many years. If the plant has flowers or seeds, place the flowers and seeds in a heavy plastic bag “head first” at the weeding site and transport to the disposal site. The following are general descriptions of disposal methods. See the chart for recommendations by species.

Burning: Large woody branches and trunks can be used as firewood or burned in piles. For outside burning, a written fire permit from the local forest fire warden is required unless the ground is covered in snow. Brush larger than 5 inches in diameter can't be burned. Invasive plants with easily airborne seeds like black swallow-wort with mature seed pods (indicated by their brown color) shouldn't be burned as the seeds may disperse by the hot air created by the fire.

Bagging (solarization): Use this technique with softer-tissue plants. Use heavy black or clear plastic bags (contractor grade), making sure that no parts of the plants poke through. Allow the bags to sit in the sun for several weeks and on dark pavement for the best effect.

Tarping and Drying: Pile material on a sheet of plastic and cover with a tarp, fastening the tarp to the ground and monitoring it for escapes. Let the material dry for several weeks, or until it is clearly nonviable.

Chipping: Use this method for woody plants that don't reproduce vegetatively.

Burying: This is risky, but can be done with watchful diligence. Lay thick plastic in a deep pit before placing the cut up plant material in the hole. Place the material away from the edge of the plastic before covering it with more heavy plastic. Eliminate as much air as possible and toss in soil to weight down the material in the pit. Note that the top of the buried material should be at least three feet underground. Japanese knotweed should be at least 5 feet underground!

Drowning: Fill a large barrel with water and place soft-tissue plants in the water. Check after a few weeks and look for rotted plant material (roots, stems, leaves, flowers). Well-rotted plant material may be composted. A word of caution- seeds may still be viable after using this method. Do this before seeds are set. This method isn't used often. Be prepared for an awful stink!

Composting: Invasive plants can take root in compost. Don't compost any invasives unless you know there is no viable (living) plant material left. Use one of the above techniques (bagging, tarping, drying, chipping, or drowning) to render the plants nonviable before composting. Closely examine the plant before composting and avoid composting seeds.





Japanese knotweed
Polygonum cuspidatum
USDA-NRCS PLANTS Database /
Britton, N.L., and A. Brown. 1913. *An illustrated flora of the northern United States, Canada and the British Possessions*. Vol. 1: 676.

Be diligent looking for seedlings for years in areas where removal and disposal took place.

Suggested Disposal Methods for Non-Native Invasive Plants

This table provides information concerning the disposal of removed invasive plant material. If the infestation is treated with herbicide and left in place, these guidelines don't apply. Don't bring invasives to a local transfer station, unless there is a designated area for their disposal, or they have been rendered non-viable. This listing includes wetland and upland plants from the New Hampshire Prohibited Invasive Species List. The disposal of aquatic plants isn't addressed.

Woody Plants	Method of Reproducing	Methods of Disposal
Norway maple <i>(Acer platanoides)</i> European barberry <i>(Berberis vulgaris)</i> Japanese barberry <i>(Berberis thunbergii)</i> autumn olive <i>(Elaeagnus umbellata)</i> burning bush <i>(Euonymus alatus)</i> Morrow's honeysuckle <i>(Lonicera morrowii)</i> Tatarian honeysuckle <i>(Lonicera tatarica)</i> showy bush honeysuckle <i>(Lonicera x bella)</i> common buckthorn <i>(Rhamnus cathartica)</i> glossy buckthorn <i>(Frangula alnus)</i>	Fruit and Seeds 	<p>Prior to fruit/seed ripening</p> <p>Seedlings and small plants</p> <ul style="list-style-type: none"> ▪ Pull or cut and leave on site with roots exposed. No special care needed. <p>Larger plants</p> <ul style="list-style-type: none"> ▪ Use as firewood. ▪ Make a brush pile. ▪ Chip. ▪ Burn. <hr/> <p>After fruit/seed is ripe</p> <p>Don't remove from site.</p> <ul style="list-style-type: none"> ▪ Burn. ▪ Make a covered brush pile. ▪ Chip once all fruit has dropped from branches. ▪ Leave resulting chips on site and monitor.
oriental bittersweet <i>(Celastrus orbiculatus)</i> multiflora rose <i>(Rosa multiflora)</i>	Fruits, Seeds, Plant Fragments 	<p>Prior to fruit/seed ripening</p> <p>Seedlings and small plants</p> <ul style="list-style-type: none"> ▪ Pull or cut and leave on site with roots exposed. No special care needed. <p>Larger plants</p> <ul style="list-style-type: none"> ▪ Make a brush pile. ▪ Burn. <hr/> <p>After fruit/seed is ripe</p> <p>Don't remove from site.</p> <ul style="list-style-type: none"> ▪ Burn. ▪ Make a covered brush pile. ▪ Chip – only after material has fully dried (1 year) and all fruit has dropped from branches. Leave resulting chips on site and monitor.

Non-Woody Plants	Method of Reproducing	Methods of Disposal
<p>garlic mustard (<i>Alliaria petiolata</i>)</p> <p>spotted knapweed (<i>Centaurea maculosa</i>)</p> <ul style="list-style-type: none"> ▪ Sap of related knapweed can cause skin irritation and tumors. Wear gloves when handling. <p>black swallow-wort (<i>Cynanchum nigrum</i>)</p> <ul style="list-style-type: none"> ▪ May cause skin rash. Wear gloves and long sleeves when handling. <p>pale swallow-wort (<i>Cynanchum rossicum</i>)</p> <p>giant hogweed (<i>Heracleum mantegazzianum</i>)</p> <ul style="list-style-type: none"> ▪ Can cause major skin rash. Wear gloves and long sleeves when handling. <p>dame's rocket (<i>Hesperis matronalis</i>)</p> <p>perennial pepperweed (<i>Lepidium latifolium</i>)</p> <p>purple loosestrife (<i>Lythrum salicaria</i>)</p> <p>Japanese stilt grass (<i>Microstegium vimineum</i>)</p> <p>mile-a-minute weed (<i>Polygonum perfoliatum</i>)</p>	<p>Fruits and Seeds</p> 	<p>Prior to flowering</p> <p>Depends on scale of infestation</p> <p>Small infestation</p> <ul style="list-style-type: none"> ▪ Pull or cut plant and leave on site with roots exposed. <p>Large infestation</p> <ul style="list-style-type: none"> ▪ Pull or cut plant and pile. (You can pile onto or cover with plastic sheeting). ▪ Monitor. Remove any re-sprouting material. <hr/> <p>During and following flowering</p> <p>Do nothing until the following year or remove flowering heads and bag and let rot.</p> <p>Small infestation</p> <ul style="list-style-type: none"> ▪ Pull or cut plant and leave on site with roots exposed. <p>Large infestation</p> <ul style="list-style-type: none"> ▪ Pull or cut plant and pile remaining material. (You can pile onto plastic or cover with plastic sheeting). ▪ Monitor. Remove any re-sprouting material.
<p>common reed (<i>Phragmites australis</i>)</p> <p>Japanese knotweed (<i>Polygonum cuspidatum</i>)</p> <p>Bohemian knotweed (<i>Polygonum x bohemicum</i>)</p>	<p>Fruits, Seeds, Plant Fragments</p> <p>Primary means of spread in these species is by plant parts. Although all care should be given to preventing the dispersal of seed during control activities, the presence of seed doesn't materially influence disposal activities.</p>	<p>Small infestation</p> <ul style="list-style-type: none"> ▪ Bag all plant material and let rot. ▪ Never pile and use resulting material as compost. ▪ Burn. <p>Large infestation</p> <ul style="list-style-type: none"> ▪ Remove material to unsuitable habitat (dry, hot and sunny or dry and shaded location) and scatter or pile. ▪ Monitor and remove any sprouting material. ▪ Pile, let dry, and burn.

January 2010

UNH Cooperative Extension programs and policies are consistent with pertinent Federal and State laws and regulations, and prohibits discrimination in its programs, activities and employment on the basis of race, color, national origin, gender, religion, age, disability, political beliefs, sex, sexual orientation, or veteran's, marital or family status. College of Life Sciences and Agriculture, County Governments, NH Dept. of Resources and Economic Development, Division of Forests and Lands, NH Fish and Game ,and U.S. Dept. of Agriculture cooperating.

(This Page Is Intentionally Blank)

APPENDIX D

R-Tank Operation, Inspection, and Maintenance

(This Page Is Intentionally Blank)



R-TANK OPERATION, INSPECTION & MAINTENANCE

Operation

Your ACF R-Tank System has been designed to function in conjunction with the engineered drainage system on your site, the existing municipal infrastructure, and/or the existing soils and geography of the receiving watershed. Unless your site included certain unique and rare features, the operation of your R-Tank System will be driven by naturally occurring systems and will function autonomously. However, upholding a proper schedule of Inspection & Maintenance is critical to ensuring continued functionality and optimum performance of the system.

Inspection

Both the R-Tank and all stormwater pre-treatment features incorporated into your site must be inspected regularly. Inspection frequency for your system must be determined based on the contributing drainage area, but should never exceed one year between inspections (six months during the first year of operation).

Inspections may be required more frequently for pre-treatment systems. You should refer to the manufacturer requirements for the proper inspection schedule.

With the right equipment your inspection and measurements can be accomplished from the surface without physically entering any confined spaces. If your inspection does require confined space entry, you **MUST** follow all local/regional requirements as well as OSHA standards.

R-Tank Systems may incorporate Inspection Ports, Maintenance Ports, and/or adjoining manholes. Each of these features are easily accessed by removing the lid at the surface. With the cover removed, a visual inspection can be performed to identify sediment deposits within the structure. Using a flashlight, ALL access points should be examined to complete a thorough inspection.

Inspection Ports

Usually located centrally in the R-Tank System, these perforated columns are designed to give the user a base-line sediment depth across the system floor.

Maintenance Ports

Usually located near the inlet and outlet connections, you'll likely find deeper deposits of heavier sediments when compared to the Inspection Ports.

Manholes

Most systems will include at least two manholes - one at the inlet and another at the outlet. There may be more than one location where stormwater enters the system, which would result in additional manholes to inspect.

Bear in mind that these manholes often include a sump below the invert of the pipe connecting to the R-Tank. These sumps are designed to capture sediment before it reaches the R-Tank, and they should be kept clean to ensure they function properly. However, existence of sediment in the sump does **NOT** necessarily mean sediment has accumulated in the R-Tank.

After inspecting the bottom of the structure, use a mirror on a pole (or some other device) to check for sediment or debris in the pipe connecting to the R-Tank.

R-TANK OPERATION INSPECTION & MAINTENANCE

If sediment or debris is observed in any of these structures, you should determine the depth of the material. This is typically accomplished with a stadia rod, but you should determine the best way to obtain the measurement.

All observations and measurements should be recorded on an Inspection Log kept on file. We've included a form you can use at the end of this guideline.

Maintenance

The R-Tank System should be back-flushed once sediment accumulation has reached 6" or 15% of the total system height. Use the chart below as a guideline to determine the point at which maintenance is required on your system.

R-Tank Unit	Height	Max Sediment Dept
Mini	9.5"	1.5"
Single	17"	3"
Double	34"	5"
Triple	50"	6"
Quad	67"	6"
Pent	84"	6"

Before any maintenance is performed on your system, be sure to plug the outlet pipe to prevent contamination of the adjacent systems.

To back-flush the R-Tank, water is pumped into the system through the Maintenance Ports as rapidly as possible. Water should be pumped into ALL Maintenance Ports. The turbulent action of the water moving through the R-Tank will suspend sediments which may then be pumped out.

If your system includes an Outlet Structure, this will be the ideal location to pump contaminated water out of the system. However, removal of back-flush water may be accomplished through the Maintenance Ports, as well.

For systems with large footprints that would require extensive volumes of water to properly flush the system, you should consider performing your maintenance within 24 hours of a rain event. Stormwater entering the system will aid in the suspension of sediments and reduce the volume of water required to properly flush the system.

Once removed, sediment-laden water may be captured for disposal or pumped through a Dirtbag™ (if permitted by the locality).



2831 Cardwell Road
Richmond, Virginia, 23234
800.448.3636
FAX 804.743.7779
acfenvironmental.com

Step-By-Step Inspection & Maintenance Routine

1) Inspection

- a. Inspection Port
 - i. Remove Cap
 - ii. Use flashlight to detect sediment deposits
 - iii. If present, measure sediment depth with stadia rod
 - iv. Record results on Maintenance Log
 - v. Replace Cap
- b. Maintenance Port/s
 - i. Remove Cap
 - ii. Use flashlight to detect sediment deposits
 - iii. If present, measure sediment depth with stadia rod
 - iv. Record results on Maintenance Log
 - v. Replace Cap
 - vi. Repeat for ALL Maintenance Ports
- c. Adjacent Manholes
 - i. Remove Cover
 - ii. Use flashlight to detect sediment deposits
 - iii. If present, measure sediment depth with stadia rod, accounting for depth of sump (if present)
 - iv. Inspect pipes connecting to R-Tank
 - v. Record results on Maintenance Log
 - vi. Replace Cover
 - vii. Repeat for ALL Manholes that connect to the R-Tank

2) Maintenance

- a. Plug system outlet to prevent discharge of back-flush water
- b. Determine best location to pump out back-flush water
- c. Remove Cap from Maintenance Port
- d. Pump water as rapidly as possible (without over-topping port) into system until at least 1" of water covers system bottom (See project specific Note L).
- e. Replace Cap
- f. Repeat at ALL Maintenance Ports
- g. Pump out back-flush water to complete back-flushing
- h. Vacuum all adjacent structures and any other structures or stormwater pre-treatment systems that require attention
- i. Sediment-laden water may be captured for disposal or pumped through a Dirtbag™.
- j. Replace any remaining Caps or Covers
- k. Record the back-flushing event in your Maintenance Log with any relevant specifics
- L. Care to be taken to preserve and maintain the stone and filter layer below the chambers during the periodic system back-flush and vacuuming process.

APPENDIX E

Flexstorm Inlet Filter, Inspection, and Maintenance

(This Page Is Intentionally Blank)



FLEXSTORM™ Inlet Filter Specifications and Work Instructions

Product: FLEXSTORM FULL TRASH CAPTURE (FTC) INSERTS

Manufacturer: ADS - FLEXSTORM www.inletfilters.com

A subsidiary of Advanced Drainage Systems (ADS) www.ads-pipe.com

1.0 Description of Work:

- 1.1 The work covered shall consist of supplying, installing, and maintaining/cleaning of the FLEXSTORM FULL TRASH CAPTURE (FTC) INSERT. The FLEXSTORM FTC INSERT is placed directly under a catch basin drainage grate in order to collect trash and debris from surface storm water runoff as part of a TMDL program, or as directed by the Engineer.

2.0 Material:

- 2.1 The FLEXSTORM FTC insert system is comprised of a stainless steel frame and basket with perforated openings. The basket hangs suspended from the rigid frame at a distance below the grate that shall allow full water flow into the drainage structure if the basket is completely filled with trash and debris.



- 2.2 The FLEXSTORM FTC frame includes lifting handles to facilitate installation and removal of the basket into and out of the drainage structure. The ultimate bypass in the frame is designed to exceed that of the design flow into the drainage structure.
- 2.3 FLEXSTORM FTC INSERTS for full trash capture initiatives: The FLEXSTORM FTC framing is comprised of 12GA 304 stainless steel. The active filtering component is 14GA perforated stainless steel. The steel basket is uniformly punched with 3/16" dia holes (4.8 mm) in such a pattern that the basket has 50% open area and retains any particles 5 mm or larger.



3.0 Identification of Drainage Structures to Determine FLEXSTORM FTC Part #s, and Sizing:

3.1 The Installer (Contractor) shall inspect the plans and/or worksite to determine the quantity of each drainage structure casting type. The catch basin design, casting number, or the exact grate and clear opening size will provide the information necessary to identify the required FLEXSTORM FTC insert part number. Inserts are supplied to the field pre-configured to fit the specified drainage structure.

3.2 Standard Part Numbers and Performance Ratings:

FLEXSTORM Performance Specifications - Full Trash Capture						
ADS-FLEXSTORM P/N	Basin Size	Basket Depth	Ultimate Bypass Flow Rate (CFS)*	Storage Volume (ft ³)	Flow Rate when Empty (CFS)*	Flow Rate when 50% Full (CFS)*
62HD12FTC	12 x 12	12"	0.5	0.7	6.8	3.0
62HD18FTC	18 x 18	12"	1.8	1.7	12.2	4.5
62HD24FTC	24 x 24	12"	3.0	3.1	18.6	6.3
62HD3618FTC	36 x 18	12"	4.0	3.5	20.8	7.3
62HD3624FTC	36 x 24	12"	4.5	5.0	25.1	8.3
62HD36FTC	36 x 36**	12"	8.0	7.1	41.6	14.6

* Calculated with .33' head pressure above grate

** Two 36 x 18 filter baskets placed side by side

4.0 Installation into Standard Grated Drainage Structures:

4.1 Remove the grate from the casting or concrete drainage structure. Clean the ledge (lip) of the casting frame or drainage structure to ensure it is free of stone and dirt. Lower the FLEXSTORM insert through the clear opening and be sure the suspension hangers rest firmly on the support ledge of the structure. Replace the grate and confirm it is elevated no more than 1/8", which is the thickness of the steel hangers.



(This Page Is Intentionally Blank)

APPENDIX F

Chloride Management Plan

(This Page Is Intentionally Blank)

CHLORIDE MANAGEMENT PLAN

F O R

The Village at Banfield Woods

**Portsmouth, New Hampshire
Rockingham County**

Tax Map 256, Lot 2

May 5, 2020

Prepared By:



Civil Engineers
Structural Engineers
Traffic Engineers
Land Surveyors
Landscape Architects
Scientists

(This page is intentionally blank)

Introduction/Background

TFMoran, Inc. has prepared the following Chloride Management Plan for The Village at Banfield Woods, Portsmouth, New Hampshire. The subject property is located within a chloride-impaired watershed per NHDES One Stop Data Mapper. The intent of this plan is to provide the owner, and future property managers/owners of the site with proper de-icing application procedures and techniques during winter snow and ice management. The contractor in charge of winter storm management shall refer to this document when developing a Winter Maintenance Plan.

Elevated chloride levels are harmful to aquatic life, plants, drinking water and groundwater, infrastructure, automobiles, etc. The use of salt in this area should be reduced in order to meet water quality standards. Salt is often over applied to reduce liability. Property owners or managers who hire Commercial Salt Applicators certified by NHDES under RSA 489-C are granted limited liability protection against damages arising from snow and ice conditions.

Development Area Description

The residential development is located upon a 45-acre parcel on Banfield Road, Portsmouth, NH. The development consists of a $\pm 1,000'$ cul-de-sac access to 22 single-family residential houses. Associated improvements include access, grading, utilities, stormwater management system, lighting, and landscaping. The project proposes approximately 60,000 SF of impervious area, excluding roofs. (Refer to the "Stormwater Operation and Maintenance Plan" for site layout.)

The post-development condition is characterized by primarily one watershed divided into many subcatchment areas which discharge into adjacent wetlands. Post-development subcatchment areas are depicted on the plan entitled "Stormwater Operation and Maintenance Plan".

Stormwater runoff from the site discharges primarily towards the existing wetlands (POI-1) and a small portion discharges off-site to an existing wooded area (POI-2).

Operational Guidelines

The owner shall be responsible for an inspection and maintenance program specified in the Stormwater Management System Operation & Maintenance Manual and the following minimum specifications for de-icing, anti-icing and pretreatment practices, and equipment. These measures will help to reduce potential environmental impacts. By following the enclosed procedures, The Village at Banfield woods will be able to reduce chloride from site-generated stormwater runoff.

Winter Operator Certification Requirements: All employees or contractors responsible for winter maintenance shall be a NH Certified Salt Applicator. Certified Salt Applicators must attend the NH Green SnowPro Training offered by the University of New Hampshire Technology Transfer Center, pass the exam, and apply and renew certifications annually. The NH Green SnowPro Training course focuses on efficient, more environmentally friendly winter maintenance practices that do not compromise road, parking lot and sidewalk safety. For training information, visit the UNH Technology Transfer Center webpage at: <http://t2.unh.edu/green-snowpro-trainingand-nhdes-certification>.

Weather Monitoring: Weather monitoring will be the responsibility of the contractor in charge of winter storm management. Contractors should be proactive for storm events and develop a communication plan identifying key personnel responsible for weather monitoring and activating the Winter Maintenance Plan.

Equipment Calibration Requirements: Calibrating equipment is the most important aspect to achieving salt use reductions, typically by 25%. Calibration should be performed annually or after a spreader is serviced. Calibration for spreading machines shall be done using the techniques detailed per the following NHDES links:

- Hydraulic Spreader Calibration:
<https://www.des.nh.gov/organization/divisions/water/wmb/was/salt-reduction-initiative/documents/bmp-hydro-calib.pdf>
- Pony Motor-Run Spreader Calibration:
<https://www.des.nh.gov/organization/divisions/water/wmb/was/salt-reduction-initiative/documents/bmp-pm-calib.pdf>

Mechanical Removal: The contractor shall clear all parking and sidewalk areas and store snow in designated snow storage areas, per the Stormwater Operation & Management Plan. Snow removal frequency shall be conducted at the contractors' discretion with respect to site safety and weather conditions. Excess snow shall be transported off-site for disposal in accordance with NHDES regulations. If snow is stored within parking areas, keep catch basins clear. Plow snow before applying deicers or sand.

De-Icing and Sand Application & Storage: Reduced use of sodium chloride (road salt) may be used for deicing. Alternative uses to road salt are de-icing materials such as calcium magnesium acetate (CMA) and limited use of abrasives (sand, sawdust, cat litter). Learn about the deicer ingredients and use the appropriate one for the condition, pre-wetting and brine practices, and appropriate application rate and locations. Do not apply sodium chloride for pavement temperatures below 15°F nor deicers for pavement temperatures under -10°F. Use deicers appropriately prior to the storm. Separate salt and sand and store and contain appropriately. Use salt or deicers for melting; use sand for traction. Sand shall be swept and properly disposed of. The following techniques for sanding and de-icing application are detailed per the following NHDES website links:

- Road Salt Techniques:

<https://www.des.nh.gov/organization/divisions/water/wmb/was/salt-reduction-initiative/documents/bmp-salt-works.pdf>

- Anti-Icing Techniques:
<https://www.des.nh.gov/organization/divisions/water/wmb/was/salt-reduction-initiative/documents/bmp-anti-icing.pdf>
- Brine Making for Road Salt:
<https://www.des.nh.gov/organization/divisions/water/wmb/was/salt-reduction-initiative/documents/bmp-brine.pdf>
- Pre-Wetting Anti-Icing Agents:
<https://www.des.nh.gov/organization/divisions/water/wmb/was/salt-reduction-initiative/documents/bmp-pre-wet.pdf>
- Material Storage and Housekeeping
<https://www.des.nh.gov/organization/divisions/water/wmb/was/salt-reduction-initiative/documents/bmp-housekeep.pdf>

Salt Usage Evaluation and Monitoring

The contractor shall document usage and application of calcium chloride and deicers with “Smart De-Icing Practices Checklist” (Attachment 1) and “De-Icing Application & Equipment Calibration Log” (Attachment 2). These documents shall be kept to monitor salt usage and application procedures in order to improve salt minimization methods and materials, reduce de-icing materials quantities and cost, and planning for future storms.

This Chloride Management Plan is a living document and shall be updated annually shortly following the winter season. Procedures should be updated as necessary to incorporate technology improvements or any BMP’s, town regulations, or changes to state or federal permit conditions that result in private developers or contractors to alter practices. To make sure the most recent version of the Salt Minimization Plan is being utilized the contractor shall keep a log of amendments made to the plan.

(This page is intentionally blank)

ATTACHMENT 1

Smart Salting Practices

(This page is intentionally blank)

Smart Salting Practices

Recommended practice	Check which response applies to current practices and anticipated site maintenance activities for job site.				
	Already do	Will do	Might do	Will not do	If "will not do"... why not?
Use an application rate chart.					
Calibrate equipment each year.					
Learn about the deicer ingredients and use the appropriate one for the condition.					
Look for reasons if and why materials are leaking or spilling from vehicles and fix them (e.g. gaps, overfilling, etc).					
Develop a comprehensive winter maintenance policy. Follow your					
Measure and use pavement temperatures.					
Use anti-icing appropriately prior to the storm.					
Plow before applying deicers.					
Use wet materials (pre-wet or pre-treated).					
Don't apply sodium chloride (road salt) for pavement temperatures below 15°F.					
Don't apply deicers for pavement temps under -10° F. It's too cold.					
Separate salt and sand. Use salt for melting. Use sand for traction.					
Apply deicers in the center of the road or on the high side of the curve.					
Store the salt in a building or under secure cover.					
Store salt away from water flow and direct the water away from storage area.					
Store snow away from lakes, ponds and wetlands.					
Sweep up sand, dispose of properly.					
For each event, document what you did and how well it worked. Use this information to make improvements.					

(This page is intentionally blank)

ATTACHMENT 2

Deicing Log

(This page is intentionally blank)

(This page is intentionally blank)

ACF R-Tank Systems Installed with PVC Liner : MA, NH, & ME

Watch Factory – Waltham, Massachusetts : Installed 2013
165 Cambridge Park Drive – Cambridge, Massachusetts : Installed 2014
Thomas Landers Parking Lot – Falmouth, Massachusetts : Installed 2016
249 Third Street – Cambridge, Massachusetts : Installed 2019
Wildwood Flood Mitigation – Winchester, Massachusetts : Installed 2019
21 Revere Beach Boulevard – Revere, Massachusetts : Installed 2020

Fairview Nursing Home – Hudson, New Hampshire: Installed 2013
EMD Millipore – Jaffrey, New Hampshire : Installed 2015
Owen Marine – Hooksett, New Hampshire : Installed 2019

72 Bishop Street – Portland, Maine : Installed 2016
Hall School – Portland, Maine : Installed 2018
Maine Medical Center – Portland, Maine : Installed 2018
Wessex Woods – Portland, Maine : Installed 2019
Western Maine Health – Norway, Maine : Installed 2020

The projects listed in the attachment are a sampling of R-Tank projects located in New England states that were lined with an impermeable liner (typically a 30ml PVC). In each of these projects, the R-Tank system bottom was either in close proximity to the ground water table or in fact below the seasonal high ground water table elevation. The use of 30ml PVC liner to separate the R-Tank storage from the ground water table is common practice for these scenarios. Based on so many development sites with poorly draining soils, shallow groundwater tables and shallow bedrock elevations, the majority of detention systems specified in New England using the R-Tank include impermeable liners. Beyond New England – ACF has supported the specification and installations of hundreds of systems from NY to NJ to PA to MD to DE with impermeable liners. Based on sites with poorly draining soils, shallow groundwater tables and bedrock elevations.

From: [Aaron Cheever](#)
To: [Jack McTigue](#)
Cc: [Chris Rice](#)
Subject: RE: Stormtech systems in the Ground Water Table
Date: Monday, April 13, 2020 9:59:20 AM
Attachments: [image004.png](#)

Hi Jack,

Please see below for a list off the top of my head/from my Files:

Dover High School – Dover, NH
Gundalow Landing – Dover, NH
Holderness School – Holderness, NH
Klemm Family Gas Station & Carwash – Salem, NH
RL Vallee – Littleton, NH
Salem Ford – Salem, NH
Tropic Star – Hampstead, NH
Tuscan Village Apartments – Salem, NH
West End Yard – Portsmouth, NH (Project going to Construction this year)

CarMax – South Portland, ME
Duluth Trading Company (55 Maine Mall Road) – South Portland, ME
Falmouth Memorial Library – Falmouth, ME
Harborchase Assisted Living – South Portland, ME
McDonald's – Presque Isle, ME
Row Row/Dirigo Plaza – Westbrook, ME
Tru Hotel – South Portland, ME
Webster Street Stormwater Improvements – Lewiston, ME

Insulet Manufacturing – Acton, MA
MBTA Green Line Extension Project – Somerville, MA

There are plenty more in MA than the two Projects listed; those just happen to be two that I was heavily involved on the pipe side of the Project. Please let me know if you have any questions.

Feel free to forward me along the previously requested information at your leisure.

Best Regards,

Aaron Cheever, P.E.

Engineered Products Manager
Advanced Drainage Systems, Inc.
978-302-0650
www.ads-pipe.com
www.stormtech.com

TECHNICAL MEMORANDUM

DOCUMENT # 29

TO: William Straub, PE
CMA Engineers 35 Bow St
Portsmouth, NH, 03801
(603) 431-6196 wstraub@cmaengineers.com

FROM: Robert Roseen, PHD, D.WRE, PE,

DATE: May 6, 2020

RE: Peer Review #2 of R-Tank Design for The Village at Banfield Woods, Banfield Road, Portsmouth, NH by TF Moran for Green and Company Real Estate, Revised April 29, 2020.

SCOPE

Upon request of Green and Company I have conducted two peer reviews of the R-Tank Design for The Village at Banfield Woods, Banfield Road, Portsmouth, NH by TF Moran revised April 29, 2020. This review #2 serves as a final review and confirmation that concerns identified in Review #1 have been addressed.

The review included an examination of the development application of the R-Tank SD stormwater system within the roadway. The review includes the following items:

- Site Development Plans for The Village at Banfield Woods, Banfield Road, Portsmouth, NH by TF Moran for Green and Company Real Estate, Revised April 29, 2020.
- Site Development Plans for The Village at Banfield Woods, Banfield Road, Portsmouth, NH by TF Moran for Green and Company Real Estate, Revised March 20, 2020.
- R-Tank and HS-20 Loads Manufacturers Recommendations, ACF Environmental, March 2018.

SUMMARY

In my prior review (dated 4/9/2020) I had identified 4 recommended design changes to ensure the R-Tank SD design would satisfy its intended purpose of providing subsurface stormwater management. Those recommendations have all been addressed successfully and revisions are listed below.

It is my professional opinion that the R-Tank SD design will be an excellent solution for providing subsurface stormwater management filtration and detention and enables avoiding buffer disturbance. With the latest design improvements, I believe the R-Tanks will function successfully long term for water quality and operations and maintenance. It is my expectation that this system will meet AOT requirements for new development stormwater management. Filtration systems such as R-Tanks are the top performers for water quality treatment as they successfully remove a wide class of pollutants. Subsurface treatment is an often used and excellent design solution to minimize disturbed areas, such as this instance, to avoid buffer disturbance that would occur from surface treatments (e.g. bioretention, gravel wetlands, and detention ponds).

R-Tank systems have been demonstrated to work well in similar applications under roadways with modest traffic. With proper engineering oversight during construction, quality design, and sufficient pretreatment considerations, these subsurface stormwater management systems can function successfully long-term. R-Tanks functionally are similar to the use of crushed stone, perforated pipe, and chambers. System voids approximate 40% for crushed

stone, perforated pipe with stone ranges from 40-60% voids, subsurface chambers around 75%, and R-Tank about 95% voids. R-Tanks are a sensible option for space constrained locations where the 95% voids can be maximized to limit the amount of excavation and/or subsurface area required for management.

The R-Tank SD used in this application for HS-20 loads require a minimum of 18” of cover and a maximum of 108” to maintain a maximum load bearing capacity 42.9 PSI with a factor of safety ranging from 2.1 to 3.75 respectively. Sheet C-35 appears to detail more than sufficient cover to maintain load bearing capacity.

- Pretreatment should be improved.** *Pretreatment should be located in each of the upstream catch basin structures at CBI, 2, 3, and 4. Trash and debris screens and grates, pre-filtration with catch basin inserts, and others will focus maintenance activities within the pretreatment structure and reduce the maintenance demand and extend the functional life of the R-Tank system.*
Revision: The current design now includes ADS-FLEXSTORM Perforated Stainless Steel Full Trash Capture Inserts. These systems are excellent and I have seen them used successfully in similar applications.
- Filter course specifications needed.** *Sheet C-35 lists a filter layer at the base of the R-Tanks. I do not see a specification for the filter layer for the subsurface detention and filtration.*
Revision: The filter course is an ASTM C33 sand with less than 2% passing the #200 sieve and is in accord with other designs I have worked with in the past.
- Maintenance ports.** *Sheet C-35 provides a detail for a maintenance port however the locations and number of ports are not detailed in the long-section or on the grading and drainage sheet C-10.*
Revision: The locations and number of ports are now detailed in the long-section on C-39 and on the grading and drainage sheet C-10. There are 2 maintenance ports shown on each R-Tank system with the specific location identified. This allows for proper monitoring of the system.
- Construction phasing.** *A construction phasing plan will need to be developed to plan for the possibility of HS25 loading that would exceed design loads during construction.*
Revision: I have reviewed the construction sequencing and phasing plan and it carefully addresses the details of system construction and phasing to provide for necessary construction activities and protection of the R-Tank system. The phasing plan should provide sufficient protection from the anticipated heavy trucking during construction.

I am satisfied that the current design has addressed my concerns and will function as intended, is constructable, and will provide excellent water quality protection through the use of the innovative R-Tank systems. I would be happy to discuss these items in more detail if helpful.

Regards,



Robert M. Roseen, Ph.D., P.E., D.WRE.

9 Gretas Way | Stratham, NH 03885

(603)686-2488(c) | roseen@waterstone-eng.com

May 06, 2020

Mr. Michael Green
Green and Company
11 Lafayette Road
North Hampton, New Hampshire 03862

Subject: **The Village at Banfield Woods**
Banfield Road (Map 256 – Lot 2); Portsmouth, New Hampshire
KNA Project No. 20-0410-2

Dear Mr. Green:

At your request we have completed an independent third party review of design plans and supporting information prepared in support of a certain innovative stormwater treatment system planned near the site entrance to the subject residential development. Specifically, the scope of our review was limited to consideration of design accommodations for a proposed underground stormwater treatment system, to be generally situated beneath Stations 2+00± and 3+00± of a future private roadway intended to provide exclusive access to twenty-two currently planned detached residential dwellings. In keeping with your instructions our review of this planned construction principally focused on assessment of anticipated system performance and constructability. Further, at your request we also contemplated the possible existence of alternate solutions given your site contractor's anticipation of high construction cost associated with furnishing and installing the system as currently proposed. Specific documents considered and reviewed by this office to date include:

- A Site Plan (40 drawings); dated September 25, 2019 and last revised on March 20, 2020; prepared by TF Moran, Inc.;
- A letter (geotechnical) report entitled "Proposed Stormwater Treatment System Assessment", dated February 28, 2020; prepared by Milone & MacBroom;
- A "Drainage Analysis", dated December 27, 2019 and last revised on March 23, 2020; prepared by TF Moran, Inc.;
- A Work Area/Construction Sequence Plan (one drawing); prepared by Severino Trucking in concert with TF Moran, Inc.; and
- Copies of miscellaneous correspondence by and between members of your project team related to elements of proposed design and construction.

At the outset of our engagement we sought to understand the genesis of the innovative, or low impact design (LID) approach to stormwater management currently planned. Based upon input from your civil/site engineers (TF Moran, Inc.) we understand the project's initial design

Civil Engineering

Land Surveying

Landscape Architecture

contemplated installation of a gravel wetland constructed to the east of Stations 1+00± to 2+00± of the planned private roadway. We understand this solution was ultimately rejected by City Officials due to its proposed placement within and encroachment upon a wetland buffer required under applicable provisions of the City's Zoning Ordinance. Although we had neither opportunity nor need to evaluate the previous design solution, based upon review of Sheet C-09 of the current Site Plan, it appears the current solution serves to both avoid and minimize impact to land situated within the specified wetland buffer situated immediately west and east of the future private roadway. Nevertheless, based upon our consideration and review of the currently proposed stormwater management solution we offer the following remarks:

System Concept and Performance:

In addition to need for compliance with applicable local land use ordinances and regulations (City Code) governing stormwater management, this project invokes jurisdiction of the New Hampshire Department of Environmental Services (NHDES) Alteration of Terrain Bureau and CHAPTER Env-Wq 1500 of the New Hampshire Code of Administrative Rules (NHDES Rules). Both NHDES Rules and City Code mandate quantitative mitigation and qualitative treatment of site-generated post-development stormwater volumes.

As shown on various site plan drawings, the planned Underground Stormwater Treatment System (USTS) is intended to receive untreated stormwater runoff from paved street and driveway surfaces, roofs and future lawn captured by four stormwater catch basins. As shown on the project plans, each proposed catch basin will be equipped with both deep (48") sumps and hooded outlets. These improvements collectively provide a level of stormwater pre-treatment sufficient to satisfy applicable NHDES Rules prior to arrival at the planned USTS. Specifically, it is anticipated these pre-treatment methods will effectively capture and remove both floatable and non-floatable solids from the stormwater stream prior to introduction to the planned USTS. The design engineer has estimated specific volumes of stormwater tributary to the USTS for the 2, 10, 25 and 50 year return frequency design storm events. As best illustrated on Sheets C-09 & C-39 of the site plan, stormwater captured by catch basins is introduced to each of four separate subsurface bio-retention systems which collectively comprise the USTS.

As designed, the USTS is intended to serve two separate mitigative functions. One function is quantitative attenuation of post-development stormwater discharge volumes prior to release to the surrounding environment. Specifically, as shown on the project plans the USTS has been designed to provide subsurface stormwater storage of a volume sufficient to accommodate the required detention function by use of multi-module configurations of R-Tank chambers. Much like any stormwater detention system designed in accordance with applicable NHDES Rules, the USTS has been designed to provide storage volume sufficient to receive calculated in-flow volumes for all design storm events up to and including the 50-year return frequency event. In the current instance, mitigation of peak stormwater discharge from the USTS will be achieved by limiting discharge of accumulated stormwater volumes exiting the system during the 25 and 50 year return frequency design storm events by use of four separate outlet control structures (OCS). Site specific details of OCS construction are provided on Sheet C-39 of the site plan. Attenuation of post development stormwater volumes and the required stormwater treatment (qualitative) functions are to be provided through construction of subsurface bio-retention

capabilities situated directly beneath each proposed R-Tank installation. As shown on Sheet C-39 of the site plan, stormwater tributary to the planned R-Tank installations is to be “filtered” through an 18 inch thickness of “filter soil mix” comprised of ASTM C-33 concrete sand, sandy loam and organic matter in a manner identical to a typical bio-retention system or rain-garden installation exposed to atmospheric conditions. Typical of most bio-retention systems, “filtered” stormwater then accumulates in successive 3 inch and 9 inch thicknesses of pea stone and crushed stone respectively, situated directly beneath the planned filter soil mix and atop an impermeable membrane, prior to discharge via a network of 4 inch diameter perforated pipes located at the base of the USTS.

As shown on Sheet C09, treated stormwater captured by this interior network of perforated pipe will exit the USTS and ultimately discharge to the ground surface at a downstream flared end-section. Although USTS system configuration planned by the design engineer may be properly viewed as “innovative” given the “stacking” of individual detention and bio-retention best management practices, in reality the overall USTS may be properly viewed as nothing more than a “train” comprised of typical subsurface stormwater detention and bio-retention practices which have been commonly used in land development applications in New Hampshire over the past two decades. It should be noted the bio-retention practice contemplated by the current USTS design is fundamentally identical to that described and endorsed by the NHDES in the New Hampshire Stormwater Manual – Volume 2; initially published in 2008. According to data published by the NHDES, the currently planned bio-retention system would be expected to enjoy removal efficiencies of 90%, 65% and 65% respectively for total suspended solids, total nitrogen and total phosphorus on an annual basis.

As acknowledged above, the project plans specify USTS construction is to be isolated from adjoining soil and groundwater conditions by installation of a sealed 30 mil PVC membrane liner. Fundamentally, the underlying purposes of the specified liner are two-fold. One purpose is to prevent groundwater intrusion into the planned USTS. A second purpose is to form an interior “container” from which treated stormwater may be captured, absent mixing with ambient groundwater, prior to discharge. Based upon recognition that the planned membrane liner has the potential to be situated below groundwater elevation, the design engineer has made precautionary accommodations for groundwater relief in order to mitigate risks associated with uplifting buoyant force. Specifically, as recommended in the referenced Milone and MacBroom report, TF Moran has included specific provisions for exterior groundwater relief via installation of a 12 inch thickness of crushed stone and 4 inch diameter perforated pipe located directly beneath the USTS liner. As shown on the project plans, this planned groundwater relief system is intended to discharge to the ground surface at an elevation lower than the base elevation of the USTS. Given uncertainties implicit in attempting to predict groundwater behavior, we believe the design engineer’s planned accommodation for groundwater relief is both warranted and properly conceived.

Structural Considerations:

Upon initial review of the project plans we quickly noticed the planned USTS is to be situated directly beneath a future private street. For a variety of reasons, including logistics associated with maintaining site access during USTS installation and corresponding incremental construction cost, we sought to identify an alternate system location. Specifically, we endeavored to identify an alternate location for USTS construction which would not require system placement directly beneath a proposed street. Based upon our attempts to identify such a location it quickly became obvious why the design engineer has proposed the USTS location as currently shown on the project plans. In addition to being substantially positioned outside of the required wetland buffer (again, we understand genesis of the current USTS concept to be based on City Officials prior rejection of gravel wetland construction within the required wetland buffer), current USTS location affords site grading opportunities necessary for proper system configuration, operation and discharge. Specifically, as shown on Sheet C-21 of the project plans, the planned USTS is to be situated beneath a roadway segment having a vertical slope of six percent. Incremental soil cover accumulated over the length of the system not only accommodates the full height of stacked R-Tank and bio-retention system construction but also enables the overall USTS system to be constructed to an elevation which affords direct and convenient storm drain and groundwater relief system discharge at desirable outfall locations absent the need for incremental impact to the protected wetland buffer. All in all, our endeavor to identify an alternate USTS location ultimately served to demonstrate current system location is both appropriate and possibly without viable alternative.

Construction of underground stormwater systems beneath paved site driveway and parking surfaces is not unusual. In fact, given convergence of an increasing demand for developable land, advances in innovative stormwater system technologies, and continued adoption of increasingly rigorous regulatory design and performance standards applicable to stormwater treatment works, construction of subsurface stormwater management systems has become increasingly common. That said each time a subsurface system is contemplated it is important to verify that workmanship and materials to be incorporated into the proposed construction may be expected to yield an improvement that will remain structurally sound over the long term. In the current instance it is necessary to confirm the proposed R-Tank system and its foundation system will remain capable of accommodating vertical design loading imposed by vehicular traffic over the long term.

Product data provided by the manufacturer of R-Tank system components (ACF Environmental) suggests all system components are HS-20 load rated. Since this is the same load rating most often used in the design and construction of highway bridge systems, parking structures and the like, we are satisfied the R-Tank system will prove structurally adequate for this planned application. Likewise, we understand the contributing geotechnical engineers anticipate, based on depth of excavation, the USTS system will be constructed over competent subgrade. If so, we have little to no consternation over this planned construction provided installation is performed in a manner fully consistent with R-Tank manufacturer's published specifications and recommendations.

Constructability:

For reasons noted at the outset of remarks offered in regard to structural considerations, our initial reaction to the proposed design included a concern that USTS placement could serve to frustrate site construction scheduling since system installation will require significant excavation immediately followed by a variety of sustained construction activities directly within the “footprint” of the main site access corridor. This concern was further exacerbated by need to avoid additional wetland buffer impacts which would result from construction of a temporary work road by-passing the planned USTS installation. Given our understanding this project currently remains in the planning, design and permitting stage we were surprised to learn your project team, which includes Severino Trucking, had already devised a seven phase work area plan addressing this very point. Based upon our review of the construction sequence contemplated by this work plan we are confident USTS installation can be efficiently accomplished despite our initial concerns related to construction site access.

As acknowledged by the Work Plan, initial phases of USTS installation will necessitate bulk excavation of native soil material in the immediate vicinity of proposed construction. We would find it remarkable if the extent of excavation required does not ultimately require at least a modest amount of dewatering. If your project team has not yet identified a site specific plan for dewatering, we recommend this be coordinated in advance of construction as part of Storm Water Pollution Prevention Plan (SWPPP) preparation for the project. We recommend specific care be taken not only to properly dewater the work area but also to avoid discharge of evacuated groundwater to land areas situated within the adjacent wetland buffer. Given our anticipation that City Officials will continue to be vigilant in their administrative duty to ensure construction activities respect the integrity of adjacent wetland buffers, we also recommend temporary construction fencing be erected at approved work area limits in the immediate vicinity of USTS and entrance roadway construction.

Conclusions:

Based upon our consideration and review of design accommodations for construction of an underground stormwater treatment system planned in the vicinity of roadway Stations 2+00± to 3+00± we offer the following series of concluding remarks:

1. We understand City Officials previously rejected the design engineer’s initial proposal to satisfy certain regulatory requirements governing treatment of site generated stormwater via construction of a gravel wetland practice within an area of wetland buffer situated immediately east of the southerly 200 feet of the planned private street. Subsequent to this rejection, we understand the design engineer identified the alternate solution involving construction of the underground stormwater treatment system (USTS) specified on the current site plan. The current USTS design, which incorporates R-Tank storage chambers as well as bio-retention, makes accommodations for quantitative mitigation of post-development stormwater discharge volumes as well as qualitative accommodations for stormwater treatment, which in identical fashion to the previously specified gravel wetland, satisfies NHDES Rule requirements for stormwater treatment without necessity of additional impact to adjoining wetland buffer City Officials sought to avoid.

2. Given prevailing topography, wetland boundary and corresponding wetland buffer geometries our attempt to identify alternate location(s) for construction of improvements necessary to satisfy applicable regulatory requirements governing stormwater management proved unsuccessful. Despite anticipated incremental cost and unavoidable influence on critical path of construction, it appears our unsuccessful attempt at identifying a viable alternative inadvertently demonstrates necessity of continued pursuit of the currently proposed LID solution. In our view this solution is both appropriate and possibly without viable alternative.
3. Installation of the USTS as currently proposed eliminates wetland buffer impacts previously proposed in order to accommodate construction of gravel wetlands. It should be recognized that both construction of initial (gravel wetland) and current (bio-retention) best management practices equally satisfy applicable NHDES Rules governing stormwater treatment.
4. Our review of detailed design plans of proposed USTS construction revealed no significant concerns or departures from common industry standards applicable to the design and construction of the proposed innovative or low impact design (LID) solution.
5. Based upon recognition that USTS installation will temporarily occupy much of the “footprint” area available for temporary construction site access, members of your project team, including TF Moran and Severino Trucking, collaborated on preparation of a seven phase work area plan intended to address the same. Based upon our review of the proposed work area plan we are satisfied the specified approach will prove workable.
6. We recommend the Stormwater Pollution Prevention Plan (SWPPP) prepared prior to commencement of construction include site specific accommodations for dewatering of the USTS installation area, as well as installation of temporary construction fencing at the limit of approved work area immediately adjacent to wetland buffers.

We trust you will find the content of this brief letter report responsive to your recent request. In the event you should have specific questions or seek clarification relative to our remarks, please contact this writer at your convenience.

Sincerely:

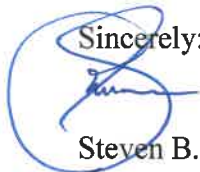

Steven B. Keach, P.E.
President
Keach-Nordstrom Associates, Inc.





Civil Engineers
Structural Engineers
Traffic Engineers
Land Surveyors
Landscape Architects
Scientists



June 1, 2020

TFM Project No: 47361.00

Phil A. Corbett
CMA Engineers, Inc.
35 Bow Street
Portsmouth, NH 03801-3819

Re: May 13, 2020 Review of Stormwater and Drainage for the “The Village at Banfield Woods”

Dear Phil:

On behalf of our client, Green & Company, TF Moran, Inc. (TFM) respectfully submits the following material in response to your comments dated May 13, 2020.

- Letter from ACF dated May 21, 2020 concerning the maintenance and operation of the R-Tank systems.
- Letter from Severino Trucking Co., Inc. dated May 22, 2020 concerning the reliability of Underground Stormwater Treatment Systems (USTS) such as the proposed R-Tank system.
- Letter from Keach-Nordstrom Associates, Inc dated May 29, 2020 concerning R-Tank use and maintenance.
- Operation and Maintenance Manual for Village at Banfield Woods, Last Revised May 28, 2020.
- Drainage Analysis for the Village at Banfield Woods, dated December 27, 2019 and last revised on May 5, 2020.
- Revised Site Development Plans (50 drawings), dated September 25, 2019 and last revised May 5, 2020.

To facilitate your review of the plans, we have provided your comments, along with our responses which are shown in blue.

1. The drainage analysis and plans should be stamped by a New Hampshire professional engineer.
The drainage analysis and plans submitted to the Planning Board will be stamped. We have also included a stamped drainage analysis and plans with this letter.
2. Label sub-drainage basins on Pre-Drainage Plan and fix legend.
The labels of the sub-drainage basins on Pre-Drainage Plan have been added and the Legend updated.
3. Guardrail should be provided adjacent to the roadside retaining wall (station 5+20 to 6+60).
During the April 7, 2020 Technical Advisory Committee (TAC) meeting, TFMoran explained that the AASHTO Guidelines for Geometric Design of Low-Volume Roads – Second Edition – 2019, did not require guardrail in this location. AASHTO recognized that on low volume roads, “major expenditures to provide clear zones will generally have only limited crash reduction benefits and are not likely to be cost-effective”. TAC stated that if we met AASHTO standards, guardrail is not necessary.

A clear zone is defined as the portion of roadway that is free from obstructions. This is the zone used to determine guardrail need. The clear zone, or recovery area, is 5.5’ for this project. AASHTO defines low volume roads as having less than 400 trips per day. The projected traffic on this project is 138 to 180 trips per day, far less than the 400 per day limit.



*The Conservation Commission felt a guardrail would impede larger wildlife from using the wildlife crossings. **The crossings were a major concern of the Commission and the reason we removed guardrail from these areas.***

Below is a clip from Section 4.7, 4.7.1.1 and 4.7.1.2 of AASHTO's Guidelines for Geometric Design of Low-Volume Roads – Second Edition – 2019.

Section 4.7:

The roadside design is the one major determinant of crash frequency and severity on low-volume roads, if for no other reason than that multiple-vehicle collisions on the roadway are rare. Both the safety literature and the risk assessment conducted by Neuman (11) indicate that run-off-road crashes on roads with design volumes of 400 vehicles per day or less occur so infrequently as to make any minimum clear zone width demonstrably not cost-effective. In many cases, the provision of additional clear zone width increases construction costs and involves additional right-of-way acquisition which potentially has both cost and environmental concerns.

Section 4.7.1 and 4.7.1.1:

4.7.1 New Construction

Roadside design guidelines applicable to new construction of low-volume roads are presented below. The guidelines address both clear zone width and traffic barrier warrants and are appropriate for all functional subclasses of low-volume roads.

4.7.1.1. Clear Zone Width

The risk assessment discussed in Section 3.4 of this guide found that it is not generally cost-effective to provide clear zones, also known as clear recovery areas, on low-volume roads. Nevertheless, a clear zone of any width should provide some contribution to crash reduction. Thus, where clear zones can be provided on low-volume roads at little or no additional cost, their incorporation in designs should be considered. Clear zones may also be appropriate on horizontal curves where the minimum radius of curvature is not provided. However, major expenditures to provide clear zones will generally have only limited crash reduction benefits and are unlikely to be cost-effective. The design guidelines for roadside clear zone width on low-volume rural roads with design volumes of 400 vehicles per day or less are as follows:

1. At locations where a clear recovery area of 6 ft [2 m] or more in width can be provided at low cost and with minimum social or environmental impacts, provision of such a clear recovery area should be considered.
2. Where constraints of cost, terrain, right-of-way, or potential social or environmental impacts make the provision of a 6-ft [2-m] clear recovery area impractical, clear recovery areas less than 6 ft [2 m] in width may be used, including designs with 0 ft [0 m] clear recovery areas.

Section 4.7.2:

4.7.1.2 Traffic Barriers

The use of guardrail or other traffic barriers to protect drivers from roadside obstructions is not generally cost-effective for roads with design volumes of 400 vehicles per day or less. This finding has been confirmed in studies by Stephens (12) and Wolford and Sicking (18). Guardrail itself is a roadside obstacle, and a significant proportion of vehicle impacts with guardrail produce injuries. The costs to maintain guardrail and the low frequency of collisions with guardrail that is provided generally make it impractical for use on roads with low traffic volumes. For low-volume roads with design volumes above 400 vehicles per day, designers may exercise engineering judgment concerning the placement of guardrail at locations where the potential consequences of departure from the roadway are likely to be extremely severe.

4. The R-Tanks, as proposed, are constructed in ledge (20'+ cut) below the groundwater (likely perched on ledge), and partially under the subdivision access roadway. With input from our reviews, other engineers, and contractors, the applicant has revised the design to better accommodate these conditions. The engineering analysis concludes the system can manage groundwater and provide the intended stormwater flow attenuation and water quality treatment. We concur with that engineering analysis; and the proposed construction sequencing appears reasonable.

However, as with any subsurface stormwater system, the proposed R-Tanks are more difficult to monitor for maintenance issues and failures, and repairs are difficult, particularly because they are partially under the subdivision access road. A conventional surface water quality treatment Best Management Practice (BMP), such as gravel wetlands, bioretention area or similar, would be easier to construct and maintain. A surface BMP could be constructed outside the wetlands buffer and capture a similar area of runoff from developed areas but would likely displace a residential unit (station 2+50 right).

We selected the R-Tank system because it provides more treatment of pavement with no impact to the buffer, other than the outlet pipes, and is easily maintained. The system meets all state and city requirements and has been reviewed by two other design firms, and an engineering consulting firm, that confirm its suitability in this application. Furthermore, the R-Tank system has been specifically designed for the site conditions and is being reviewed by engineers at NHDES.

A gravel wetland at station 2+50 right would either require more wetland buffer impacts or would treat less paved surface than the R-Tank system. Further, another form of treatment such as an R-Tank system would be required to treat the 100'-150' of road below a gravel wetland at station 2+50.

To avoid buffer impact, the top of the pond must be at the same elevation as the wetland buffer. Thus, the top of the pond would need to be at elev. 42.0. With an average depth of 2', the pond bottom would be at elev. 40.0. This would extend the required pond surface beyond the single unit at 2+50. In addition, the 3:1 slope from the proposed ground to the pond bottom would be several feet above the neighboring properties. This would be unsightly to the abutting homes.

There would also be a significant reduction in the amount of roadway that could be collected into a gravel wetland. On the right (incoming) side, the top of the pond area would be the limiting factor on available treatment. To keep the gravel wetland from flowing towards the road limits the treated pavement area starts about station 3+00. With the R-Tank, roadway stormwater can be treated up to station 1+94, an additional 106' of pavement. On the left (outgoing) side, the treatment would start at approximate station 3+40, leaving 145' of additional untreated pavement.

As mentioned in the Keach-Nordstrom letter, a second option would be to provide the full treatment in the gravel wetland. The current design with R-Tanks provides treatment to an approximate road elevation of

35' and above. Pipe cover, pipe slopes and pond storage would leave the bottom surface of a gravel wetland at an elevation of approximately 30'. This would entail about 14' to 17' of cut and lower the gravel wetland to 12' below the elevation of the wetland on the north and east sides of this upland. The outlet of this gravel wetland would need to be 32" (standard requirement) below the pond surface, at an elevation of approximately 27.3', meaning that a wetland impact would be required to drain it. This gravel wetland would be aesthetically unpleasing and would cause additional wetland impact.

We have included a letter from ACF, the R-Tank supplier, discussing maintenance of the R-Tank system, and a letter from Severino Trucking Co., Inc., who have installed and maintained these Underground Stormwater Treatment Systems (USTS) for decades, which address their reliability and benefits over a gravel wetland. In consultation with ACF and Severino, we have provided the proper bedding, cover, and installation sequencing on the plans. Additionally, we have incorporated the comments of City Staff and Waterstone Engineering.

Maintenance of R-Tank systems entails regular visual inspection through maintenance ports to monitor sediment build-up. When necessary, the sediment is removed by flushing and disposal by a commercial vendor, similar to catch basin sumps.

Maintenance of a gravel wetland is also required, and can often involve more effort than regular USTS maintenance - wetland vegetation must be installed and maintained, accumulated dead vegetation removed, rodent tunnels repaired, inlets and outlets inspected and cleaned, etc.

For either system, regular maintenance is required and will be part of condominium documents. Written records must be kept and submitted to the City annually. Since USTS maintenance requires specialized equipment, it is therefore done by trained professionals. Gravel wetland maintenance is usually done by landscapers who may or may not appreciate the special requirements involved. For any system, proper maintenance is required to ensure long term system performance.

In summary, the gravel wetland, even if it could fit within the current layout, would require additional buffer impacts, would be unsightly, and would leave several hundred feet of untreated pavement. A smaller R-Tank system or stormwater management practice would still be required at the low point of the road to treat stormwater from station 2+50 to the low-point. The R-Tank system is a more safe and reliable system that can treat more pavement area than the gravel wetland, is easier to maintain, and does not require a wetland adjacent to 2 units. Its pollutant removal efficiency is among the highest for DES-approved stormwater BMP systems and meets all state and city standards.

We continue to recommend the R-Tank system as the preferred system for high-quality stormwater treatment for the private road and needs of this project. Any maintenance required, although none expected, would be paid for by the condominium association with no maintenance requirements of the city.

We trust the above responses satisfy your concerns expressed in your May 13th review letter. If you have any other concerns or comments, please contact us.

Sincerely,
TFMoran, Inc.

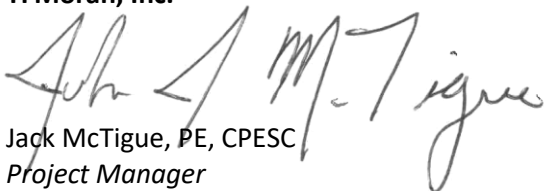

Jack McTigue, PE, CPESC
Project Manager

cc: Green and Company
Juliet Walker (City of Portsmouth)

----- Forwarded message -----

From: **William Straub** <wstraub@cmaengineers.com>
Date: Wed, Jun 3, 2020 at 1:55 PM
Subject: RE: Message From Michael Green
To: Michael Green <mgreen@greenandcompany.com>
CC: Philip A. Corbett <pcorbett@cmaengineers.com>

Mike,

Please see the attached email from Juliet Walker to Jack McTigue. At this point, we do not anticipate providing additional reviews on the project beyond what's been submitted. Our last letter, in a nutshell, concludes that TFM's final design presented for the underground tank system is satisfactory and meets required performance standards, and also commented on likely comparative long term O&M issues of that system with conventional surface systems.

I have been very aware of the relevant issues development of the review at each stage of this, and the reviews represent our firm's team approach for this type of work.

Please direct any comments, including if desired the email presented below directly to the City's planning department.

Best,

Bill

William A. Straub, P.E.
Principal/Project Manager



CMA Engineers, Inc.
[35 Bow Street](#)
[Portsmouth, NH 03801](#)
603-431-6196
www.cmaengineers.com

From: Juliet T.H. Walker <jthwalker@cityofportsmouth.com>

Sent: Wednesday, June 03, 2020 12:29 PM

To: Jack McTigue <jmctigue@tfmoran.com>

Cc: J. Corey Colwell <ccolwell@tfmoran.com>; Peter L. Britz <plbritz@cityofportsmouth.com>; Philip A. Corbett <pcorbett@cmaengineers.com>; William Straub <wstraub@cmaengineers.com>; Dave Desfosses <djdesfosses@cityofportsmouth.com>

Subject: RE: Regarding CMA's Comment Letter Dated May 13, 2020 - 4 of 4

Jack,

It was the City's understanding that the third party review of this project was complete. We do not anticipate CMA doing another round of review at this stage. Any additional information should be included in your submission to the Planning Board.

Best,

Juliet T. H. Walker, AICP

Planning Director

Planning Department

City Hall

1 Junkins Ave

Portsmouth, NH 03801

(603) 610-7296

www.cityofportsmouth.com/planportsmouth

Twitter: @PlanPortsmouth

Facebook: @plan.portsmouth

Office Hours: M 8-6, T-Th 8-4:30, F 8-1

From: Jack McTigue [<mailto:jmctigue@tfmoran.com>]

Sent: Monday, June 1, 2020 4:50 PM

To: Phillip A. Corbett (pcorbett@cmaengineers.com) <pcorbett@cmaengineers.com>; Bill Straub <wstraub@cmaengineers.com>; Juliet T.H. Walker <jthwalker@cityofportsmouth.com>

Cc: J. Corey Colwell <ccolwell@tfmoran.com>

Subject: Regarding CMA's Comment Letter Dated May 13, 2020 - 4 of 4

Phil,

This is the 4th of 4 emails concerning your May 13th comments. Let us know if you do not receive all 4 emails.

Sincerely,

Jack McTigue, PE, CPESC

Project Manager



Civil Engineers
Structural Engineers
Traffic Engineers
Land Surveyors
Landscape Architects
Scientists

ACF Environmental
2831 Cardwell Road, Richmond, VA 23234
Phone: 800-448-3636
Fax: 804-275-4132
www.acfenvironmental.com



May 21, 2020

DOCUMENT # 32

Jack McTigue, PE, CPESC
Project Manager
TFMoran, Inc.
48 Constitution Drive
Bedford, NH 03110

Re: Banfield Woods, Portsmouth, NH
R-Tank System Review Comment-Response

Jack,

Thanks for forwarding the review comments regarding the R-Tank systems proposed on the Banfield Woods project in Portsmouth, NH to ACF Environmental for review. We were requested to respond to the following comment:

However, as with any subsurface stormwater system, the proposed R-Tanks are more difficult to monitor for maintenance issues and failures, and repairs are difficult, particularly because they are partially under the subdivision access road. A conventional surface water quality treatment Best Management Practice (BMP), such as gravel wetlands, bioretention area or similar, would be easier to construct and maintain. A surface BMP could be constructed outside the wetlands buffer and capture a similar area of runoff from developed areas but would likely displace a residential unit (station 2+50 right).

In response to this comment, ACF offers the following:

- Upon proper installation and maintenance of systems, repairs are typically non-existent or very rare.
- There is no real difference between the maintenance requirements from one system to the next. All will require some level of maintenance to perform their function properly. The concern of any owner should focus on the PROCESS for maintenance, which is indeed different for every system.
- The maintenance process for R-Tank has been thoroughly vetted through hundreds of engineers from around the world who have selected R-Tank for their installation. Our process is well-documented (see our Operation, Inspection, and Maintenance Manual) and relatively simple. We focus efforts on pre-treatment using Trash Guard Plus, which prevents sediment, trash, and debris from entering the modules. Trash Guards keep debris right in the catch basins where it can be easily removed. You have an ADS metal screen unit proposed – which will function in a similar way to do the bulk of protecting the system. The contractor should ensure that these devices are installed prior to the R-Tank system being brought on-line. During construction phase appropriate upstream inlet protection should be in place to protect the system also.
- We include Maintenance Ports throughout the system in a belt-and-suspenders approach which allows for complete system backflushing should pre-treatment not perform as

anticipated (or never get maintained). Using the maintenance ports for maintenance is more effective on smaller, linear systems – so that will certainly be an advantage of the way you have your systems laid out.

- It is this approach, with maintenance at top-of-mind, that makes R-Tank an ideal choice for this project. Note that ALL of the processes involved in maintaining an R-Tank can be completed from the surface, with no confined space entry requirements. That means there are MANY contractors from the area that are equipped to perform the process. Compare that with an open vault type system which requires significant training and equipment to physically enter and maintain.

Please review the above and let us know if you have additional questions on this matter.

As previously promised, ACF will provide periodic site visits and inspections to monitor progress and ensure the installation is being conducted in accordance with our standard installation procedures and can provide simple training to property management/maintenance post construction etc.

We look forward to working with you on this project.

Sincerely,



Robert J Woodman,
Senior Stormwater Engineer
ACF Environmental

CC: Lee Jones, Rick Fotino, ACF Environmental

P.O. Box 202

Phone: 603-483-2133

www.severinotrucking.com

Candia, NH 03034

Fax: 603-483-2998

May 22, 2020

Phil A. Corbett
CMA Engineers, Inc.
35 Bow Street
Portsmouth, NH 03801-3819

**Re: Response to Comments on
Review of Stormwater and Drainage for the "The Village at Banfield Woods"
Developer: Green & Company
CMA #1134.30**

Dear Phil:

On behalf of our client, Green & Company, Severino Trucking Co., Inc. respectfully submits the following in response to the comments on the Review of Stormwater and Drainage for "The Village at Banfield Woods".

Our response is related to comment #4 on page 2 of the letter as copied below.

4. The R-Tanks, as proposed, are constructed in ledge (20'+ cut) below the groundwater (likely perched on ledge), and partially under the subdivision access roadway. With input from our reviews, other engineers, and contractors, the applicant has revised the design to better accommodate these conditions. The engineering analysis concludes the system can manage groundwater and provide the intended stormwater flow attenuation and water quality treatment. We concur with that engineering analysis; and the proposed construction sequencing appears reasonable.

However, as with any subsurface stormwater system, the proposed R-Tanks are more difficult to monitor for maintenance issues and failures, and repairs are difficult, particularly because they are partially under the subdivision access road. A conventional surface water quality treatment Best Management Practice (BMP), such as gravel wetlands, bioretention area or similar, would be easier to construct and maintain. A surface BMP could be constructed outside the wetlands buffer and capture a similar area of runoff from developed areas but would likely displace a residential unit (station 2+50 right).

The 20' cut is referenced from existing ground surface. To construct to road box section alone at this station is 15 of the 20-foot cut. The R-Tanks are only 7.5 feet below centerline finish grade of the road at this station.

The "Groundwater Table" by definition is "the upper surface of the saturated zone of saturation beneath the ground". If there is any perched water on this pinnacle of ledge it is not "Groundwater".

The groundwater is somewhere in that ledge cut, more then likely just slightly up gradient of the down gradient wetland. Regardless of the exact elevation, through the design process with the assistance of the geotechnical engineer, the ground water has been addressed with the proposed under-drains beneath the system.

Regarding the "*failures*". In our 45 years of business we have installed thousands of square feet of underground detention systems. To date we have never had to repair or replace one underground system. Nor have we had a complaint or concern about an underground system.

Second, regarding the "*gravel wetlands, bioretention area or other*". We have also built numerous rain gardens, bioretention basins, wet basins, and gravel wetlands. Unlike the underground systems, we are consistently either cleaning, repairing and in some cases replacing the above grade systems.

Speaking from my 36 years of hands on experience in this industry, there is no comparison to the systems. The only part of that paragraph that I would agree with is that the surface BMP is "*easier*" to construct, but the maintenance and operation of the surface systems are horrible. This is for one simple reason; it is exposed to the elements.

Even if the basin is maintained on one day, a windy fall storm with heavy rains the next day will mask and plug the infiltration surface and many times plug the small orifice in the outlet structure. It is a common occurrence to get complaints about surface treatment BMP's after the project is completed and residents are moved in.

The complaints are typically about the standing water. They fear the areas that do not drain quickly enough are a mosquito breeding ground. So typically, our visit reveals that leaves have plugged the small orifice in the outlet structure. In some cases, the leaves mask the surface and slow the infiltration rate to a point of making the area unsightly to the residents, regardless of how many times we explain that the water will eventually recede, they still dislike the periods of un-slightly standing water.

Ultimately as you know the residents have a powerful voice with the community. In one case in Rye we had to completely replace the surface water quality basin due to complaints about long standing static water. It was \$80,000 to replace the rain garden with a system that kept the water below grade to infiltrate.

In some situations where rainstorms have a long duration, we have seen the outlet structure so plugged with debris that water breached the overflow and compromised the berm to a point that it eroded soils into the adjacent wetland.

It is the same as porous pavement, it looks great on paper, but very difficult to maintain properly in New England. Every job that we encounter porous pavement, we try to push to re-design the job using catch basins to capture the water, then get the water into an underground perforated pipe bedded in stone. You accomplish the same thing by infiltrating the water into the ground, but you take the sand and other elements out of play by keeping the treatment underground.

The simplest analogy I can relate it to is overhead powerlines versus underground power. For the past few decades, we have been pushing to keep all utilities underground. Why, for one it is more aesthetically pleasing, but the bigger reason is to remove the overhead lines from the elements to prevent power outages. No one would ever suggest running overhead power through a new subdivision because it is *"easier to construct"*, or because the conduits are *"partially under the subdivision access road"* and the repairs would be difficult. That concern is a function of proper installation to promote long term reliability.

The materials that are used today for underground construction have a life that far exceeds the longevity of the physical road itself. The thought of replacing that drainage system should be no different than replacing a watermain or a sewer main.

Having installed both systems for many years, but only repaired and replaced the above ground systems, it is my professional opinion that the R-Tank system is the best design for this project.

Sincerely,



Thomas Severino
Vice President
Severino Trucking Co., Inc.

May 29, 2020

Mr. Michael Green
Green and Company
11 Lafayette Road
North Hampton, New Hampshire 03862

**Subject: The Village at Banfield Woods
Banfield Road (Map 256 – Lot 2); Portsmouth, New Hampshire
KNA project No. 20-0410-2**

Dear Mr. Green:

As you recall, on May 6th this office issued a letter report offering comment generated as a result of completion of an independent third party review of design plans and supporting information prepared in support of a certain Underground Stormwater Treatment System (USTS) planned near the site entrance to the subject residential development. Although our May 6th report contained discussion and remarks specific to USTS concept, performance, structural integrity and constructability we were unable to address matters related to system maintenance accommodations at that time as we had yet to receive a draft of the design engineer's system operation and maintenance manual. Subsequently, on May 21st thru May 28th we received copies of the following documents together with your request that we review and comment on the same:

- Site Development Plans (43 drawings), dated September 25, 2019 and last revised May 05, 2020;
- A "Stormwater Management System Operation & Maintenance Manual for The Village at Banfield Woods" (O & M Manual); dated May 28, 2020; prepared by TF Moran, Inc.;
- Correspondence addressed to the Portsmouth Planning Department; dated May 13, 2020; prepared by CMA Engineers, Inc. (CMA correspondence);
- Correspondence addressed to your office; dated May 22, 2020; prepared by Severino Trucking Company, Inc. (Severino correspondence); and
- Email correspondence addressed to TF Moran, Inc.; dated May 13, 2020; prepared by Robert J. Woodman, P.E.; CPESC; Region Manager for ACF Environmental (ACF correspondence).

Your recent request that we review and comment on the matter of USTS operation and maintenance appears timely given conflicting remarks offered in recent correspondence prepared by CMA, Severino and ACF respectively. Although Comment No. 4 of the CMA correspondence acknowledges that: *"The engineering analysis concludes the system can manage groundwater and provide the intended stormwater flow attenuation and water quality treatment.*

Civil Engineering

Land Surveying

Landscape Architecture

We concur with that engineering analysis; and the proposed construction sequencing appears reasonable"; that comment goes on to suggest: *"the proposed R-Tanks are more difficult to monitor for maintenance issues and failures, and repairs are difficult, particularly because they are partially under the subdivision access road. A conventional surface water quality treatment Best Management Practice (BMP), such as gravel wetlands, bio-retention area or similar, would be easier to construct and maintain. A surface BMP could be constructed outside the wetland buffer and capture a similar area of runoff from developed areas but would likely displace a residential unit (Station 2+50 right).*" In response to this remark, Severino Trucking Company, Inc. (Severino), a recognized leader in civil/site construction works in the State of New Hampshire, in correspondence dated May 22nd, expresses a contrary opinion suggesting it has been their experience that operation and maintenance of surface BMP's are often more challenging than subsurface BMP's. Additionally, Robert J. Woodman, P.E., CPESC and Region Manager of ACF Environmental, in correspondence dated May 13th, has advised the design engineer that: "There is no real difference between maintenance requirements from one system to the next".

While the cited correspondence reveals an obvious lack of consensus, it also appears opinions expressed by CMA, Severino and ACF may be properly viewed as largely generic and not necessarily site specific. While it is reasonable to anticipate any group comprised of knowledgeable design professionals, contractors and suppliers may have developed conflicting preferences and opinions guiding BMP selection, placement and corresponding maintenance requirements based on their own experiences, in the current instance we believe it essential to set aside such general preferences when endeavoring to identify the most appropriate and compatible solution for this specific site. In the current instance objective BMP selection and placement is properly influenced if not driven by each of the following considerations: (a) BMP purpose and function; (b) BMP placement; (c) State and local regulatory requirements; (d) prevailing site conditions; and (e) serviceability and maintenance considerations.

Although we understand your company's project planning, design and permitting efforts have been on-going for a year or more, this office had no reason to become aware of this land development proposal until very recently. In our endeavor to conduct the third party review function you engaged us to complete on your behalf it was necessary for us to develop an understanding as to the genesis of the current USTS design. Although we have had neither opportunity nor need to review detailed design plans and calculations related to the same, we understand the initial project design contemplated construction of a gravel wetland immediately east of roadway Stations 1+00± and 2+00±. We further understand that initial design was ultimately rejected by City officials due to proposed placement within and encroachment upon a wetland buffer required pursuant to the City Zoning Ordinance. In response to that rejection, we understand your engineering consultant devised the current USTS design, which despite the necessity of additional construction cost, enables BMP placement substantially beyond the boundaries of the adjacent wetland buffer. As acknowledged by remarks offered by both this office in our letter report of May 6th, and subsequently by CMA in their correspondence of May 13th, there appears to be consensus that the currently proposed USTS can "provide the intended flow attenuation and water quality treatment" functions required for regulatory compliance without necessity of avoidable impacts to the adjacent wetland buffer. Given this acknowledgement we are puzzled as to why CMA would suggest consideration be given to

construction of a surface BMP, in the general vicinity of Station 2+50 right, absent failure on the part of your consultant to identify reasonable and realistic protocol for future operation and maintenance of the proposed USTS. Further and perhaps more importantly, is the matter of roadway elevation and regulatory need for stormwater runoff from the future paved roadway surface to be “captured”, detained and treated prior to confluence with adjacent wetlands. As shown on Sheet C-09 of the current project plans, stormwater runoff from segments of the future roadway surface above Station 1+85± is to be captured by a series of catch basins, including catch basins CB-01 & CB-02, situated at Station 1+85± left and right respectively. Both structures have a design rim elevation of 35.4. The depth afforded by the current USTS design enables stormwater runoff tributary to these two basins to enter the USTS directly at elevation 32.20; where, in keeping with applicable State and local code requirements, it is detained and treated prior to release to the adjacent wetland. In contrast, Sheet C-09 indicates all land located outside of the wetland buffer in the vicinity of Station 2+50± right is at or above elevation 42.0. Sheet C-21 specifies a finish centerline grade elevation of 39.67 at 2+50 such that the elevation of the finished paved roadway surface is lower than both adjacent land and wetland buffer

boundary elevation. While it may be possible to design and construct a series of catch basins and storm drains, sufficient to capture stormwater runoff and direct the same to a gravel wetland or some other form of surface BMP excavated in the vicinity of Sta. 2+50 right, the overall depth of alternate BMP construction would need to be approximately equal to the depth of the currently planned USTS installation if it were to serve an equal length of future paved roadway surface. In our endeavor to conceptualize layout of a surface BMP of the variety endorsed by CMA in their cited correspondence of May 13th we determined the approximate finish grade of the upper surface of such alternative BMP arrangement constructed in the general vicinity of the “footprint” of a currently planned dwelling unit situated at Station 2+50 right would need to be at or about elevation 30.0. Since the project plans indicate existing ground elevation in this vicinity ranges between 44.0 and 47.0 this would place the exposed BMP surface approximately 14 to 17 feet below existing grade and approximately 12 feet below the elevation of the adjacent wetland buffer boundary. This depth not only exceeds that of the current USTS design, but would also serve to compromise BMP effectiveness while potentially creating both an attractive nuisance and aesthetic blemish. In our opinion this outcome would border on the ridiculous and represent anything but a betterment when compared to the current USTS design solution. Simply put, based on City officials prior rejection of your design engineer’s initial proposal to construct a surface BMP within a wetland buffer we believe the current USTS design represents the best, if not only, practical solution for satisfying applicable State and local code requirements applicable to stormwater management provided it can be demonstrated corresponding USTS maintenance can be achieved in a manner that is both reasonable and practical.

As acknowledged above, we are in receipt of a copy of a project specific Stormwater Management System Operation & Maintenance Manual (O & M Manual). In addition to addressing a series of customary matters we would expect to find in any complete and properly prepared document of this type, the current O & M Manual includes text at Appendices D and E; which taken together, specify a recommended process for periodic inspection and maintenance of the planned USTS installation. We understand this process was developed by the design engineer in consultation with ACF Environmental. Since the scope of third party review completed by this office to date has generally been limited to consideration of the proposed

USTS solution, so too was our consideration of the O & M Manual. On that basis we offer the following remarks:

- As described at Appendices D & E, routine maintenance of the USTS requires periodic back-flush and vacuuming similar if not identical to several varieties of shallow subsurface stormwater infiltration, detention and treatment systems commonly employed on both residential and non-residential development sites over the past two decades. Based on the fact that individual elements of the USTS maintenance protocol specified at Appendices D & E have become common and successful practices over the past two decades we believe they will prove to be effective at this location.
- In a manner identical to this land development project, subsurface stormwater management systems are typically located beneath paved parking lots, access ways and other pervious and impervious surfaces from which stormwater tributary to the same is generated. While immediate system proximity to paved surfaces is generally dictated by unrelated design considerations, such proximity provides convenient access for equipment used to perform subsurface system maintenance functions. As shown on Sheet C-39 of the project plans, all inspection, maintenance and flushing ports, as well as all drain manholes housing pretreatment accommodations and outlet control structures, will be conveniently located either directly beneath or immediately adjacent to the planned private roadway affording convenient vehicular access for facilitation of future maintenance functions.
- Taken together, the series of common maintenance practices specified and quality of access available for equipment needed to perform the same combine to yield appropriate and achievable opportunities for sustained USTS maintenance.

Information and opinions expressed in this current letter report are intended to be supplementary to those offered in our letter report of May 6th and collectively represent our professional opinions as to the purpose, design, constructability and serviceability of the planned USTS. Should you have specific questions or require further input regarding these matters, please contact the writer at your convenience.

Sincerely:

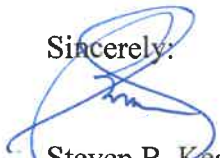

Steven B. Keach, P.E.
President
Keach-Nordstrom Associates, Inc.

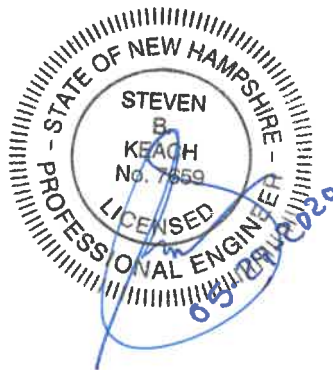



The State of New Hampshire
Department of Environmental Services



Robert R. Scott, Commissioner

REQUEST FOR MORE INFORMATION

June 29, 2020

Mr. Rick Green
Green & Company Real Estate
11 Lafayette Road
North Hampton, NH 03868
(sent via email to: grousewing1@gmail.com)

RE: Alteration of Terrain Permit Application AoT 200513-064
The Village at Banfield Woods
0 Banfield Road – Portsmouth, NH
Tax Map 256 Lot 2

Dear Mr. Green:

The Department of Environmental Services (DES) is in receipt of an application and supporting plans and information, for an Alteration of Terrain Permit for the above referenced project. After review of the information submitted, the following items need to be addressed in order for DES to make a **final determination** on the application for a permit:

1. The wetland scientist must stamp, sign and date the Existing Conditions Plan.
2. The soil scientist must stamp and sign the color soil plans or the Existing Conditions Plan.
3. The engineering plans need to be stamped, signed and dated by a Professional Engineer registered in the State of NH.
4. It is estimated that greater than 5,000 cy of rock removal will be required, therefore you are required to identify any drinking water wells located within 2,000 feet of the proposed blasting activities. If any are located, develop a groundwater quality sampling program to monitor for nitrate and nitrite either in the drinking water supply wells or in other wells that are representative of the drinking water supply wells in the area. The plan must be submitted to NHDES for approval prior to permitting, and must include pre and post blast water quality monitoring. The groundwater sampling program must be implemented as approved by NHDES.
5. The Natural Heritage Bureau (NHB) identified threatened and/or endangered (T&E) species with the datacheck tool. Follow up with the NHB (Amy Lamb) to address concerns associated with T&E species. Summarize how any comments are being addressed, and provide copies of correspondence to NHDES.
6. The total area of disturbance exceeds 5 acres. Unless the plan is phased, you are advised that the project will require environmental monitoring during construction. If the plan is to disturb no more than 5 acres at one time, include a phasing plan that clearly shows how the construction will be phased and indicate that each area must be stabilized before advancing to a successive phase. If an

www.des.nh.gov

29 Hazen Drive • PO Box 95 • Concord, NH 03302-0095
(603) 271-3503 • TDD Access: Relay NH 1-800-735-2964

environmental monitor will be used, add the requirements of Env-Wq 1505.03(d) to the plans.

7. Grading & Drainage Plans (Env-Wq 1504.09)
 - a. Bioretention Area #2: The grate elevation on Sheet C-10 does not match the detail on Sheet C-42.
 - b. Bioretention Area #2 & #3: Depict the spillway for both systems on the plans. Note the elevation.
 - c. Extend outlet protection to the toe of the fill slope for all spillways as necessary.
8. Drainage Analysis (Env-Wq 1504.09)
 - a. To allow for the analysis to evaluate the impact of the development, modify Point of Interest PPOi02 to be the inflow to the existing culvert under Banfield Road.
 - b. The total area of brush used in the Post-Development should not exceed that used in the Pre-Development. Reclaimed areas that will be planted to grow trees should be modeled as woods, good.
 - c. Do not use the cover type *woods/grass combination*. Landscaping, including areas with newly planted trees, should be modeled as *open space, good condition*.
 - d. Review the routing of subcatchments through reaches. Only the area that flows through the entire reach should be routed to that reach. These reaches should align with the Tc termination points for bordering subcatchments. The Tc path should not overlap with a reach. This will require modifying subcatchment boundaries or combining subcatchments to eliminate reaches.
9. Post-Development Drainage Analysis (Env-Wq 1504.09)
 - a. Review the cover type for the Tc calculation in the following subcatchments: PS05, PS06, PS08, and PS09b. A portion of the Tc should be through grass/lawn areas.
 - b. Review the starting location of the travel paths for PS08, PS11, and PS22. The path must start on a high point on the boundary or within the subcatchment, not mid slope.
 - c. PS09b: There is too much woods and too little grass in the area calculation.
 - d. PS22: The sheet flow portion of the Tc calculations should be over pavement.
 - e. If wetland PP02 is modeled as a pond, the inflowing Reach, PR06a, should end at the limits of the pond. It should not extend into the pond.
 - f. PR08 should be routed to PR04.
 - g. CB05 & CB06: The pipe diameter and length do not match the grading and drainage plans.
 - h. Bioretention Area #1: The 0.2" orifice has a multiplier of 0.
 - i. Bioretention Area #2 & 3:
 - i. The orifice elevation should be set 1.75' below the top of filter media to maintain a water level below the filter to provide adequate treatment through the 18" filter depth.
 - ii. OS-5 & OS-6: The outlet pipe lengths and inverts do not match the plan. The pipe diameter does not match the plan for OS-6.
 - j. Infiltration Basin #1: The spillway elevation does not match that shown on Sheet C-10.
 - k. The bottom of basin elevation for Bioretention Area #3 is 44.5 per the grading plan, 43.5 per the detail and analysis.
10. BMP Worksheets: There is a BMP worksheet on the AoT webpage for Bioretention Systems with Internal Storage Reservoirs. Please complete this worksheet for Bioretention Systems #2 and #3.
11. Drainage Details:
 - a. Specify a 12" diameter beehive grate for Bioretention System #2 & #3 to match the analysis.
 - b. Sheet C-40, 2+05 Section: The bottom of tank stone elevation should be 31.95.

- c. Sheet C-42, Hybrid Bio Detail: Move *Elevation F* up to the end cap. Remove reference to 0.75" orifice in the label for that detail and in the *Cap with Orifice Control Detail*.
 - d. Construction Exit Detail: The berm shown in the detail is required for 50' long exits.
 - e. Underground Filter Practices: After consulting with the UNH Stormwater Center, it is acceptable to specify the use of concrete sand (ASTM C-33) for the 18" filter instead of the filter media specified in Env-Wq 1508.07(k)(4). The organics specified in the filter media are needed to support vegetation and not necessary in an underground system.
12. Please note this project includes an underground detention and filtration system. **A letter signed by a qualified engineer must be provided to DES** stating that the individual observed any underground detention, infiltration, or filtering systems prior to backfilling, and whether, in his or her professional opinion, the system(s) conform to the approved plans and specifications.
 13. After any necessary revisions to the HydroCAD analysis to respond to the above, submit a revised summary table of the 2-year, 10-year and 50-year pre- and post-development flows, and if necessary, the 2-year pre- and post-development runoff volumes or 1-year flow (pre), to show compliance with the requirements of Env-Wq 1507.05(b).
 14. Pursuant to Env-Wq 1503.15(b), changes to the revised plans are to be called out and a revision date must be added to each page that has been changed. Graphical revision call-outs should be included on the plans. If any changes to the plans or the hydrologic/hydraulic analysis were made other than those identified above, please indicate what additional changes were made in your response letter.
 15. Project CD:
Please note that, in accordance with Env-Wq 1503.20(e), within one week of a project being permitted the department requires that a CD be submitted which includes a copy of the plans and the drainage report (including the summary, drainage analysis, riprap sizing calculations, USGS map, etc), all in PDF format. This will assist DES in minimizing our long-term file storage space requirements.

Please respond to this request for more information letter in accordance with the provisions of Env-Wq 1503.15. Please include the file number on your response to this request, as well as a narration of the changes from the current application. Please be aware that in accordance with RSA 485-A:17, if all of the information requested above is not provided in a **single and complete** response within the next 120 days, **October 27, 2020, your application will be denied**. If you have any questions, please call me at (603) 271-3249 or email at: michael.schlosser@des.nh.gov.

Sincerely,



Michael Schlosser, PE
Alteration of Terrain Bureau

cc: Portsmouth Planning Board (jthwalker@cityofportsmouth.com)
Jack McTigue, TFMoran, Inc. Seacoast Division (via email)