

PROPOSED SUBDIVISION CLIPPER TRADERS, LLC

105 BARTLETT STREET
PORTSMOUTH, NEW HAMPSHIRE
SUBDIVISION PLANS

OWNERS:
CLIPPER TRADERS, LLC
PO BOX 121
NEW CASTLE, NH 03854

PORTSMOUTH LUMBER AND
HARDWARE, LLC
105 BARTLETT STREET
PORTSMOUTH, N.H. 03801

BOSTON AND MAINE CORPORATION
IRON HORSE PARK
HIGH STREET
NORTH BILLERICA, MA 01862

CIVIL ENGINEER & LAND SURVEYOR:
AMBIT ENGINEERING, INC.
200 GRIFFIN ROAD, UNIT 3
PORTSMOUTH, N.H. 03801-7114
Tel (603) 430-9282
Fax (603) 436-2315

ARCHITECT:
WINTER HOLBEN
7 WALLINGFORD SQUARE
KITTERY, ME 03904
Tel (207) 994-3104

TRAFFIC ENGINEER:
STEPHEN G. PERNAW & COMPANY, INC.
PO BOX 1721
LOUDON, N.H. 03307
Tel (603) 731-8500
Fax (603) 929-6094

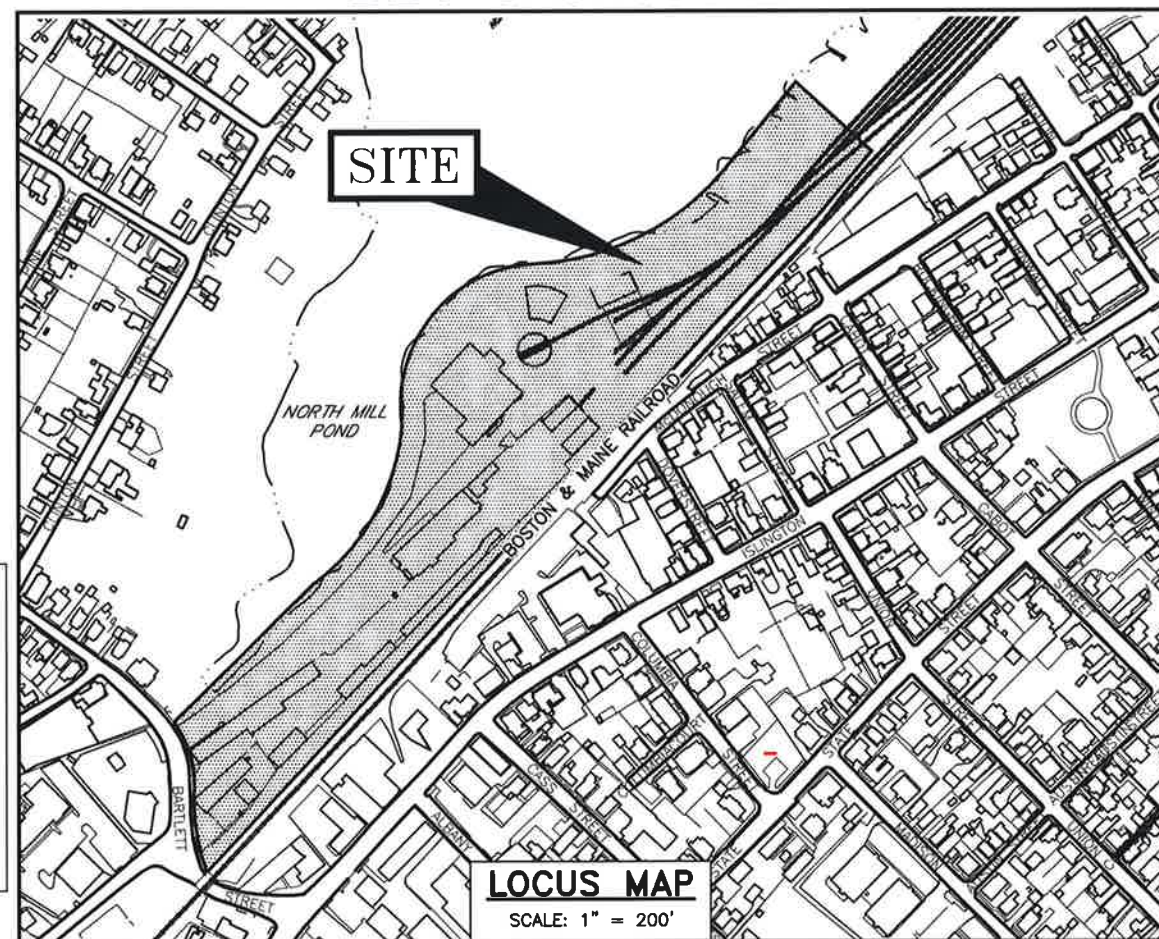
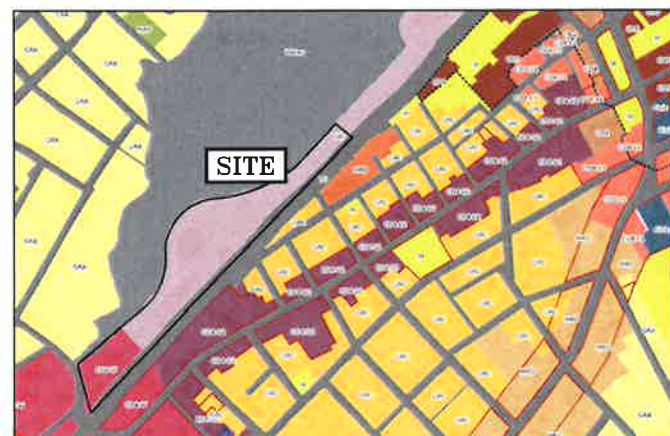

LEGEND:

N/F	NOW OR FORMERLY
RP	RECORD OF PROBATE
RCRD	ROCKINGHAM COUNTY
	REGISTRY OF DEEDS
	MAP 11/LOT 21
IR FND	IRON ROD FOUND
IP FND	IRON PIPE FOUND
IR SET	IRON ROD SET
DH FND	DRILL HOLE FOUND
DH SET	DRILL HOLE SET
	GRANITE BOUND w/IRON ROD FOUND

EXISTING	PROPOSED	
FM	FM	PROPERTY LINE
S	S	SETBACK LINE
SL	SL	FORCE MAIN
G	PG	SEWER PIPE
D	D	SEWER LATERAL
FD	FD	GAS LINE
W	W	STORM DRAIN
FS	FS	FOUNDATION DRAIN
UE	UGE	WATER LINE
OHW	OHW	FIRE SERVICE LINE
		UNDERGROUND ELECTRIC SUPPLY
		UNDERGROUND ELECTRIC SERVICE
		OVERHEAD ELECTRIC WIRES
		RETAINING WALL
		EDGE OF PAVEMENT (EP)
100	100	CONTOUR
97x3	98x0	SPOT ELEVATION
		UTILITY POLE
		ELECTRIC METER
		TRANSFORMER ON CONCRETE PAD
		ELECTRIC HANDHOLD/PULLBOX
		WATER SHUT OFF/CURB STOP
		PIPE CLEANOUT
		GATE VALVE
		HYDRANT
		CATCH BASIN
		SEWER MANHOLE
		DRAIN MANHOLE
		WATER METER MANHOLE
		TEST BORING
		TEST PIT
		LANDSCAPED AREA
CI	CI	CAST IRON PIPE
COP	COP	COPPER PIPE
CMP	CMP	CORRUGATED METAL PIPE
DI	DI	DUCTILE IRON PIPE
PVC	PVC	POLYVINYL CHLORIDE PIPE
RCP	RCP	REINFORCED CONCRETE PIPE
HYD	HYD	HYDRANT
CL	CL	CENTERLINE
EP	EP	EDGE OF PAVEMENT
EL	EL	ELEVATION
FF	FF	FINISHED FLOOR
INV	INV	INVERT
TBM	TBM	TEMPORARY BENCH MARK
TYP	TYP	TYPICAL



UTILITY CONTACTS

ELECTRIC:
EVERSOURCE
1700 LAFAYETTE ROAD
PORTSMOUTH, N.H. 03801
Tel. (603) 436-7708, Ext. 555.5678
ATTN: MICHAEL BUSBY, P.E. (MANAGER)

NATURAL GAS:
UNITIL
325 WEST ROAD
PORTSMOUTH, N.H. 03801
Tel. (603) 294-5144
ATTN: DAVE BEAULIEU

CABLE:
COMCAST
155 COMMERCE WAY
PORTSMOUTH, N.H. 03801
Tel. (603) 679-5695 (X1037)
ATTN: MIKE COLLINS

SEWER & WATER:
PORTSMOUTH DEPARTMENT OF PUBLIC WORKS
680 PEVERLY HILL ROAD
PORTSMOUTH, N.H. 03801
Tel. (603) 427-1530
ATTN: JIM TOW

COMMUNICATIONS:
CONSOLIDATED
COMMUNICATIONS
JOE CONSIDINE
1575 GREENLAND ROAD
GREENLAND, N.H. 03840
Tel. (603) 427-5525

INDEX OF SHEETS

OVERALL SUBDIVISION PLAN
SUBDIVISION PLANS
EXISTING CONDITIONS PLAN

PORTSMOUTH APPROVAL CONDITIONS NOTE:
ALL CONDITIONS ON THIS PLAN SET SHALL REMAIN IN EFFECT IN PERPETUITY PURSUANT TO THE REQUIREMENTS OF THE CITY OF PORTSMOUTH SITE PLAN REVIEW REGULATIONS.

APPROVED BY THE PORTSMOUTH PLANNING BOARD

CHAIRMAN

DATE

SUBDIVISION PLANS
PROPOSED SUBDIVISION
105 BARTLETT STREET
PORTSMOUTH, N.H.

AMBIT ENGINEERING, INC.
Civil Engineers & Land Surveyors
200 Griffin Road - Unit 3
Portsmouth, N.H. 03801-7114
Tel (603) 430-9282
Fax (603) 436-2315

PLAN SET SUBMITTAL DATE: 18 JUNE 2018

Half Size

ABUTTER LIST

- 139
1
N/F
REGAN ELECTRONIC CO. INC.
94 LANGDON STREET
PORTSMOUTH, NH 03801
2956/1527
- 144
46
N/F
MYLES S. BRATTER
177 BARTLETT STREET
PORTSMOUTH, NH 03801
2424/1690
- 163
2
N/F
INDUSTRIAL RENTS-NH, LLC
6 WAYNE ROAD
WESTFORD, MA 01886
5606/2334
- 144
37
N/F
ANDREW S. MARTIN
230 McDONOUGH STREET
PORTSMOUTH, NH 03801
5082/386
- 144
47
N/F
GREAT McDONOUGH STREET, LLC
135 McDONOUGH STREET
PORTSMOUTH, NH 03801
3440/532
- 164
5
N/F
HOUSTON HOLDINGS, LLC
653 ISLINGTON STREET
PORTSMOUTH, NH 03801
3558/464
- 144
38
N/F
HEIDI J. RAMMER
765 PARK PLACE, APT. 1
BROOKLYN, NY 11216
3484/299
- 157
6
N/F
SUMMIT 501 ISLINGTON, LLC
c/o TODD BAKER
953 ISLINGTON STREET #230
PORTSMOUTH, NH 03801
5256/441
- 164
6
N/F
NED AND BILL PROPERTIES, LLC
ATTN: WILLIAM SAVOIE
PO BOX 822
SOUTHERN PINES, NC 28388
4586/2511
- 144
41
N/F
BRANDON J. TERRY &
LAURA E. TERRY
209 McDONOUGH STREET
PORTSMOUTH, NH 03801
4322/66
- 157
7
N/F
J & J'S DROP
AND DRIVE, LLC
402 DEER STREET
PORTSMOUTH, NH 03801
5353/2395
- 164
7
N/F
HH WHOLESALERS, LLC
1 MIDDLE STREET, SUITE 1
PORTSMOUTH, NH 03801
5399/810
- 144
42
N/F
GANDACE COUTURE
199 McDONOUGH STREET
PORTSMOUTH, NH 03801
5451/2657
- 157
13
N/F
J & J'S DROP
AND DRIVE, LLC
402 DEER STREET
PORTSMOUTH, NH 03801
5353/2395
- 164
8
N/F
ARANOSIAN OIL COMPANY
557 NORTH STATE STREET
CONCORD, NH 03301
1686/263
- 144
43
N/F
HAVEN PROPERTIES, LLC
80 HAVEN ROAD
PORTSMOUTH, NH 03801
5791/2011
- 157
14
N/F
J & J'S DROP
AND DRIVE, LLC
402 DEER STREET
PORTSMOUTH, NH 03801
5353/2395
- 164
12
N/F
JOSEPH GOBBI
SUPPLY CORPORATION
PO BOX 125
PORTSMOUTH, NH 03801
3233/1949
- 144
44
N/F
RUTH E. JAMES
179 McDONOUGH STREET
PORTSMOUTH, NH 03801
5342/2028
- 157
15
N/F
J & J'S DROP
AND DRIVE, LLC
402 DEER STREET
PORTSMOUTH, NH 03801
5353/2395
- 165
1
N/F
ALAN MERTON
INVESTMENTS, LLC
PO BOX 284
STRATHAM, NH 03885
4771/1259
- 144
45
N/F
JAMES A. HEWITT REVOCABLE TRUST &
ELIZABETH E. HEWITT REVOCABLE TRUST
JAMES A. HEWITT &
ELIZABETH E. HEWITT, TRUSTEES
726 MIDDLE ROAD
PORTSMOUTH, NH 03801
5438/2237
- 158
13
N/F
SLATTERY & DUMONT, LLC
66 OLD CONCORD TURNPIKE #10
BARRINGTON, NH 03825
3471/196
- 165
14
N/F
BOSTON AND
MAINE CORPORATION
IRON HORSE PARK
HIGH STREET
NORTH BILLERICA, MA 01862
- 163
1
N/F
M & B PROPERTIES, LLC
54 BARTLETT STREET
PORTSMOUTH, NH 03801
5794/996

WETLAND NOTES:

- 1) HIGHEST OBSERVABLE TIDE LINE DELINEATED BY STEVEN D. RIKER, CWS ON 8/17/2018 IN ACCORDANCE WITH THE FOLLOWING STANDARDS:
 - A) U.S. ARMY CORPS OF ENGINEERS WETLANDS DELINEATION MANUAL, TECHNICAL REPORT Y-87-1 (JAN. 1987). AND REGIONAL SUPPLEMENT TO THE CORPS OF ENGINEERS WETLAND DELINEATION MANUAL: NORTHCENTRAL AND NORTHEAST REGION, VERSION 2.0, JANUARY 2012.
 - B) FIELD INDICATORS OF HYDRIC SOILS IN THE UNITED STATES, VERSION 8.1, USDA-NRCS, 2017 AND (FOR DISTURBED SITES) FIELD INDICATORS FOR IDENTIFYING HYDRIC SOILS IN NEW ENGLAND, VERSION 4. NEWPCC WETLANDS WORK GROUP (2017).
 - C) NATIONAL LIST OF PLANT SPECIES THAT OCCUR IN WETLANDS: NORTHEAST (REGION 1). USFWS (MAY 1988).
 - D) CLASSIFICATION OF WETLANDS AND DEEPWATER HABITATS OF THE UNITED STATES. USFW MANUAL FWS/OBS-79/31 (1997).
 - E) IDENTIFICATION AND DOCUMENTATION OF VERNAL POOLS IN NEW HAMPSHIRE (1997). NEW HAMPSHIRE FISH AND GAME DEPARTMENT.
- 2) WETLAND FLAGS WERE FIELD LOCATED BY AMBIT ENGINEERING, INC.

ZONING DISTRICT DIMENSIONAL REQUIREMENTS:

OFFICE RESEARCH (OR)*:
*PARCELS ARE SUBJECT TO EXCEPTIONS TO DIMENSIONAL STANDARDS AS OUTLINED IN CITY OF PORTSMOUTH ZONING ORDINANCE SECTION 10.532.10 & 10.532.20, MODIFIED DIMENSIONS LISTED BELOW

MIN. LOT AREA:	2 ACRES
FRONTAGE:	200 FEET
SETBACKS:	FRONT 70 FEET SIDE 50 FEET REAR 50 FEET
MAXIMUM STRUCTURE HEIGHT:	70 FEET (45 FEET WITHIN 200 FEET OF NORTH MILL POND)
MAXIMUM STRUCTURE COVERAGE:	50%
MINIMUM OPEN SPACE:	20%

CHARACTER DISTRICT 4-W (CD4-W) (NO INCENTIVES):

MIN. LOT AREA:	5,000 S.F.
FRONTAGE:	NO REQUIREMENT
SETBACKS:	FRONT (MAX.) 10 FEET (PRIMARY) FRONT (MAX.) 15 FEET (SECONDARY) SIDE NO REQUIREMENT REAR 5 FEET
MAXIMUM STRUCTURE HEIGHT:	45 FEET
MAXIMUM STRUCTURE COVERAGE:	60%
MAXIMUM BUILDING FOOTPRINT:	15,000 S.F.
MINIMUM OPEN SPACE:	15%
MINIMUM FRONT LOT LINE BUILDOUT:	50%

TRANSPORTATION CORRIDOR (TC):
NO DIMENSIONAL OR USE REQUIREMENTS DEFINED IN ORDINANCE

PORTIONS OF THESE PARCELS ARE BEING SUBMITTED FOR REZONING.

PLAN REFERENCES:

- 1) LAND IN PORTSMOUTH, N.H. BOSTON AND MAINE RAILROAD TO ERMINIO A.RICCI, SCALE : 1" = 40', APRIL 1960 RCRD 1595/091.
- 2) LAND IN PORTSMOUTH, N.H. BOSTON AND MAINE RAILROAD TO ERMINIO A.RICCI, SCALE : 1" = 40', MAY 1957 RCRD 02612.
- 3) EASEMENT OF LAND IN PORTSMOUTH, N.N. BOSTON AND MAINE RAILROAD TO UNITED STATES OF AMERICA, SCALE 1" = 20', MAY 1957, RCRD 02633.
- 4) LAND IN PORTSMOUTH, N.H. VITO P. MASSARO TO PORT CITY BEVERAGE CO, SCALE 1" = 40', APRIL 1949, RCRD 01448.
- 5) LAND IN PORTSMOUTH, N.H. MARY E. MORAN TO BOSTON AND MAINE RAILROAD, SCALE 1" = 40', MARCH 1920, RCRD 00540.
- 6) PLAN OF LAND OF MARY E. MORAN ON BARTLETT AND ISLINGTON STREETS PORTSMOUTH, N.H., PREPARED BY JOHN W. DURGIN, SCALE 1" = 20', MAY 1920, RCRD 08.
- 7) DRAINAGE EASEMENT GEORGE E. FRISBEE TO THE CITY OF PORTSMOUTH, N.H., PREPARED BY RICHARD P. MILLETTE AND ASSOCIATES, SCALE : 1" = 20', JUNE 1981, RCRD B-10456.
- 8) LAND IN PORTSMOUTH, N.H. BOSTON AND MAINE RAILROAD TO PORTSMOUTH FACTORY BUILDING ASSOCIATION, SCALE 1" = 20' OCTOBER 1923, RCRD 00356.
- 9) NH ELECTRIC CO. PLAN SHOWING AREA RESERVED FOR TRANSFORMER SUBSTATION ON PROPERTY OF CONTINENTAL SHOE CORP. PORTSMOUTH, N.H., SCALE 1" = 30', 11-27-53, RCRD 1303/378.
- 10) BOSTON AND MAINE RAILROAD PLAN TO ACCOMPANY AGREEMENT BETWEEN BOSTON AND MAINE RAILROAD AND CONCORD AND PORTSMOUTH RAILROAD COVERING RELOCATION OF TRACKS OF CONCORD AND PORTSMOUTH RAILROAD IN PORTSMOUTH, N.H. OCCASIONED BY CONSTRUCTION OF NEW HIGHWAY AND BRIDGE BY MAINE - NEW HAMPSHIRE INTERSTATE BRIDGE AUTHORITY, SCALE 1" = 500', DECEMBER 1936, RCRD 0934.
- 11) LAND IN PORTSMOUTH, N.H. BOSTON AND MAINE RAILROAD TO CITY CONCRETE CO., INC., SCALE 1" = 80', JANUARY 1955, RCRD 02897.
- 12) LAND IN PORTSMOUTH, N.H. BOSTON AND MAIN RAILROAD TO ALL STATE REALTY CORPORATION, SCALE 1" = 50', FEBRUARY 1961, RCRD 160.
- 13) LAND IN PORTSMOUTH, N.H. BOSTON AND MAINE RAILROAD TO VITO P. MASSARO, SCALE 1" = 40', APRIL 1949, RCRD 01450.
- 14) DRAINAGE EASEMENT STUART AND PAULA BOXER AND ARANOSIAN OIL COMPANY TO THE CITY OF PORTSMOUTH, N.H., PREPARED BY RICHARD P. MILLETTE AND ASSOCIATES, SCALE: 1" = 20', JUNE 1981, RCRD B-10455.
- 15) CONDOMINIUM PLAN ISLINGTON PLACE PREPARED FOR ANCHOR BUILDING ASSOCIATES, PREPARED BY KIMBALL CHASE COMPANY, INC., SCALE 1" = 20', 12-10-86, RCRD D-15826.
- 16) PLAN OF LOT 565-581 ISLINGTON STREET PORTSMOUTH, N.H., PREPARED BY JOHN W. DURGIN CIVIL ENGINEERS, SCALE 1" = 10', DECEMBER 1949 REVISED JANUARY 1963, RCRD B28.
- 17) SUBDIVISION OF LAND PORTSMOUTH, N.H. FOR GEORGE AND PAULINE J. FRISBEE, PREPARED BY JOHN W. DURGIN CIVIL ENGINEERS PROFESSIONAL ASSOCIATION, SCALE 1" = 30', DECEMBER 1976, RCRD C-6587.
- 18) RIGHT OF WAY AND TRACK MAP BOSTON AND MAINE R.R. OPERATED BY THE BOSTON AND MAINE R.R. STATION 2966+20 TO STATION 3019+0, SCALE 1" = 100', JUNE 30, 1914, VAL V3NH 55.
- 19) PLAN OF LAND FOR DEER STREET ASSOCIATES DEER AND BRIDGE STREETS AND MAPLEWOOD AVENUE PORTSMOUTH, N.H. COUNTY OF ROCKINGHAM, PREPARED BY AMBIT SURVEY, SCALE: 1" = 30', SEPTEMBER 1993.
- 20) PROPOSED EASEMENTS- BARTLETT STREET BARTLETT SEWER SEPERATION PROJECT OVER LAND OF PAN AM RAILWAYS PORTSMOUTH, NEW HAMPSHIRE FOR CITY OF PORTSMOUTH, PREPARED BY JAMES VERRA AND ASSOCIATES, INC., SCALE : 1" = 20', DATED 10-01-2007 RCRD D-35477.
- 21) SEWER AND STORM DRAIN EASEMENT PLAN 105 BARTLETT STREET PORTSMOUTH, NEW HAMPSHIRE ASSESSOR'S PARCEL 164-001 & 164-003 EASEMENT OWNER CITY OF PORTSMOUTH, PREPARED BY JAMES VERRA AND ASSOCIATES, INC., SCALE 1" = 20', DATED 01/05/2012, RCRD D-37763.
- 22) EASEMENT PLAN TAX MAP 164 - LOT 4 BOSTON & MAINE CORPORATION TO THE CITY OF PORTSMOUTH OFF BREWSTER STREET CITY OF PORTSMOUTH COUNTY OF ROCKINGHAM STATE OF NEW HAMPSHIRE, PREPARED BY AMBIT ENGINEERING, INC. SCALE: 1" = 30', DATED SEPTEMBER 2012, RCRD D-37720.
- 23) STANDARD BOUNDARY SURVEY TAX MAP 157 - LOTS 7,8,10,11,12,13,14 AND 15 WASHBURN REALTY, INC. AND WASHBURN PLUMBING AND HEATING SUPPLY COMPANY, INC. FOR JAY McSHARRY 449 & 459 ISLINGTON STREET AND 18, 30, 40, & 46 DOVER STREET AND 268 & 280 McDONOUGH STREET CITY OF PORTSMOUTH, COUNTY OF ROCKINGHAM STATE OF NEW HAMPSHIRE, PREPARED BY AMBIT ENGINEERING, INC., SCALE 1" = 20', DATED JANUARY 2012, NOT RECORDED.
- 24) SITE REDEVELOPMENT NED & BILL PROPERTIES 621-627 ISLINGTON STREET PORTSMOUTH, N.H., PREPARED BY AMBIT ENGINEERING, INC., SCALE 1" = 10', DATED MARCH 2006, NOT RECORDED.
- 25) PLAN OF LAND FOR SAGAMORE ENTERPRISES 653 ISLINGTON STREET COUNTY OF ROCKINGHAM PORTSMOUTH N.H., PREPARED BY RICHARD P. MILLETTE AND ASSOCIATES, SCALE 1" = 10', DATED SEPTEMBER 21, 1988, RCRD D-18742.
- 26) STATION MAP - LANDS BOSTON AND MAINE R.R. OPERATED BY THE BOSTON AND MAINE R.R. STATION 2966+20 TO STATION 3019+0, OFFICE OF VALUATION ENGINEER. BOSTON, MASS, SCALE 1" = 100', JUNE 30, 1914 VAL V3NH SL55.
- 27) STATION MAP - LANDS CONCORD AND PORTSMOUTH R.R. OPERATED BY THE BOSTON AND MAINE R.R. STATION 0+0 TO STATION 33+0, OFFICE OF VALUATION ENGINEER. BOSTON, MASS, SCALE 1" = 100', JUNE 30, 1914 VAL V3NH SL55A.

"I CERTIFY THAT THIS PLAN WAS PREPARED UNDER MY DIRECT SUPERVISION, THAT IT IS THE RESULT OF A FIELD SURVEY BY THIS OFFICE AND HAS AN ACCURACY OF THE CLOSED TRAVERSE THAT EXCEEDS THE PRECISION OF 1:15,000."

PAUL A DOBBERSTEIN, LLS DATE

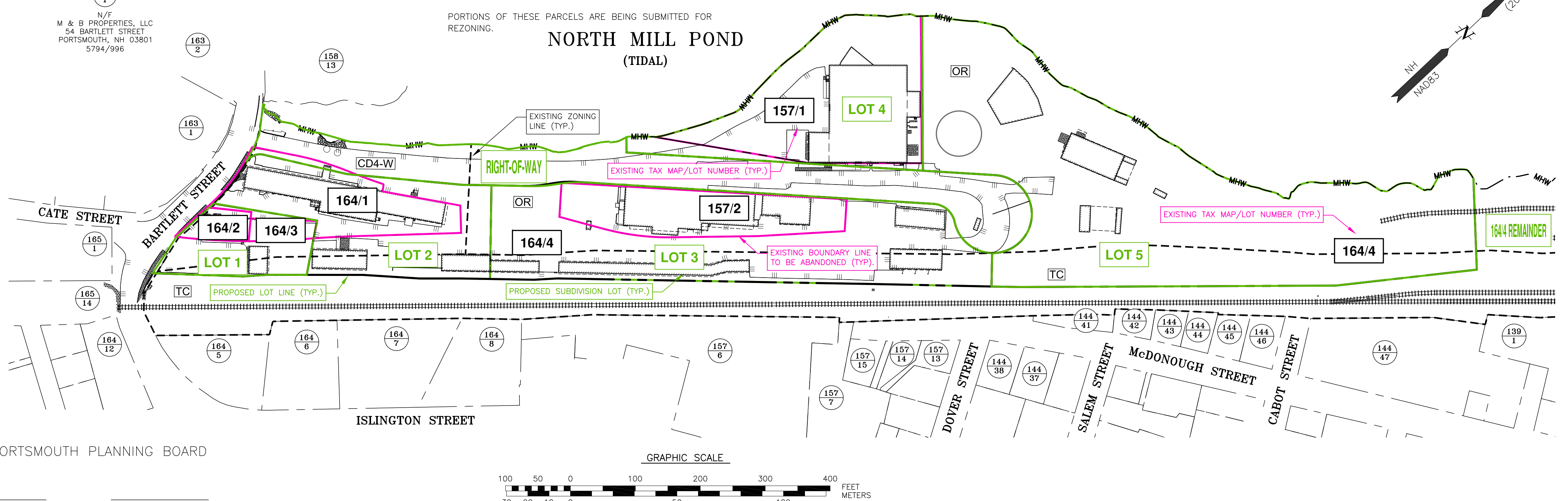

APPROVED BY THE PORTSMOUTH PLANNING BOARD

CHAIRMAN DATE

AMBIT ENGINEERING, INC.
Civil Engineers & Land Surveyors
200 Griffin Road - Unit 3
Portsmouth, N.H. 03801-7114
Tel (603) 430-9282
Fax (603) 436-2315

NOTES:
1) PARCELS ARE SHOWN ON THE CITY OF PORTSMOUTH ASSESSOR'S MAP 157 AS LOTS 1 & 2 AND ASSESSOR'S MAP 164 AS LOTS 1, 2, 3, & 4.

2) OWNERS OF RECORD:
MAP 157 LOT 1:
CLIPPER TRADERS, LLC
105 BARTLETT STREET
PORTSMOUTH, NH 03801
5598/2725

MAP 157 LOT 2:
PORTSMOUTH LUMBER AND HARDWARE, LLC
105 BARTLETT STREET
PORTSMOUTH, NH 03801
5372/2606

MAP 164 LOT 1, 2, AND 3
PORTSMOUTH LUMBER AND HARDWARE, LLC
105 BARTLETT STREET
PORTSMOUTH, NH 03801
5372/2606, 5808/1379, AND 5540/2567

MAP 164 LOT 4
BOSTON AND MAINE CORPORATION
IRON HORSE PARK
NORTH BILLERICA, MA 01862
VARIOUS DEED & PLAN REFERENCES

3) PORTIONS OF MAP 157 LOT 1 AND MAP 164 LOT 4 ARE IN A SPECIAL FLOOD HAZARD AREA AS SHOWN ON FIRM PANEL 33015C0259E. EFFECTIVE DATE MAY 17, 2005.

4) PARCELS ARE LOCATED IN CHARACTER DISTRICT 4-W (CD4-W), OFFICE RESEARCH (OR), AND TRANSPORTATION CORRIDOR (TC) ZONING DISTRICTS.

5) THE PURPOSE OF THIS PLAN IS TO SHOW THE CONSOLIDATION AND SUBDIVISION OF THE PARCELS INTO 5 LOTS AND A RIGHT-OF-WAY, AND TO RELOCATE THE LOT LINE OF MAP 164 LOT 4.

6) VARIANCES TO DIMENSIONAL REQUIREMENTS GRANTED BY THE PORTSMOUTH ZONING BOARD OF ADJUSTMENT APRIL 17, 2018.

NO.	DESCRIPTION	DATE
1	ISSUED FOR APPROVAL	6/18/18
0	ISSUED FOR COMMENT	3/5/18

OVERALL SUBDIVISION PLAN
TAX MAP 157 - LOTS 1 & 2
TAX MAP 164 -
LOTS 1, 2, 3, & 4
OWNER OF RECORD
TAX MAP 157, LOT 2 &
TAX MAP 164, LOTS 1, 2, & 3:
PORTSMOUTH LUMBER AND
HARDWARE, LLC
OWNER OF RECORD
TAX MAP 157, LOT 1
CLIPPER TRADERS, LLC
OWNER OF RECORD
TAX MAP 164, LOT 4:
BOSTON AND MAINE CORPORATION
PROPERTY LOCATED AT:
105 BARTLETT STREET
CITY OF PORTSMOUTH
COUNTY OF ROCKINGHAM
STATE OF NEW HAMPSHIRE



AMBIT ENGINEERING, INC.
Civil Engineers & Land Surveyors

200 Griffin Road - Unit 3
Portsmouth, N.H. 03801-7114
Tel (603) 430-3282
Fax (603) 436-2315

NOTES:

- 1) PARCELS ARE SHOWN ON THE CITY OF PORTSMOUTH ASSESSOR'S MAP 157 AS LOTS 1 & 2 AND ASSESSOR'S MAP 164 AS LOTS 1, 2, 3, & 4.
- 2) PORTIONS OF MAP 157 LOT 1 AND MAP 164 LOT 4 ARE IN A SPECIAL FLOOD HAZARD AREA AS SHOWN ON FIRM PANEL 33015C0259E. EFFECTIVE DATE MAY 17, 2005.
- 3) PARCELS ARE LOCATED IN CHARACTER DISTRICT 4-W (CD4-W), OFFICE RESEARCH (OR), AND TRANSPORTATION CORRIDOR (TC) ZONING DISTRICTS.
- 4) THE PURPOSE OF THIS PLAN IS TO SHOW THE CONSOLIDATION AND SUBDIVISION OF THE PARCELS INTO 5 LOTS AND A RIGHT-OF-WAY, AND TO RELOCATE THE LOT LINE OF MAP 164 LOT 4.

PROPOSED LOT AREAS & TAX MAP NUMBERS

LOT	AREA	TM/LOT #
1	20,678 S.F. 0.4747 ACRES	TO BE DETERMINED
2	51,952 S.F. 1.1927 ACRES	TO BE DETERMINED
3	102,003 S.F. 2.3417 ACRES	TO BE DETERMINED
4	61,781± S.F. 1.4183± ACRES	TO BE DETERMINED
5	177,433± S.F. 4.0733± ACRES	TO BE DETERMINED
R.O.W.	69,610± S.F. 1.5980± ACRES	TO BE DETERMINED

LENGTH TABLE

LINE	BEARING	DISTANCE
L1	S46°54'17"E	11.80'
L2	S46°49'43"E	11.20'
L3	N59°39'51"E	2'±

CURVE TABLE

CURVE	RADIUS	ARC LENGTH	CHORD LENGTH	CHORD BEARING	DELTA ANGLE
C1	60.00'	266.77'	95.37'	S05°48'40"E	254°44'33"
C2	60.00'	185.84'	119.97'	S44°26'53"E	177°28'07"
C3	60.00'	80.92'	74.93'	S82°55'23"W	77°16'26"
C4	35.00'	45.66'	42.49'	S84°11'20"W	74°44'33"
C5	150.00'	38.24'	38.14'	S39°30'52"W	14°36'24"
C6	200.00'	42.87'	42.79'	S38°21'07"W	12°16'55"
C7	25.00'	31.80'	29.70'	S19°56'09"W	72°52'42"
C8	288.61'	48.94'	48.88'	N21°21'40"W	9°42'56"
C9	288.61'	9.89'	9.89'	N00°32'28"E	1°57'48"
C10	288.61'	80.91'	80.65'	N08°28'19"W	16°03'46"

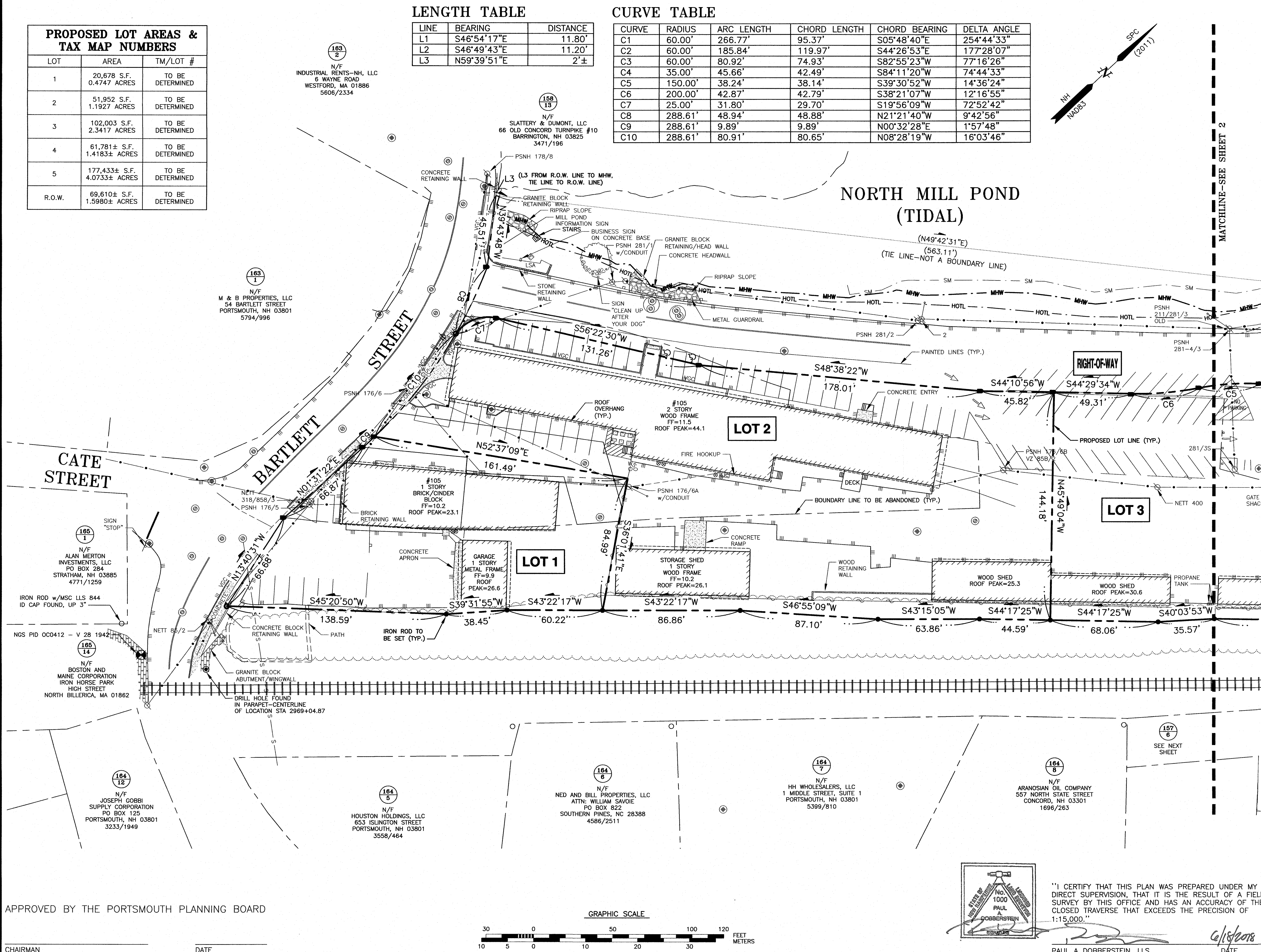
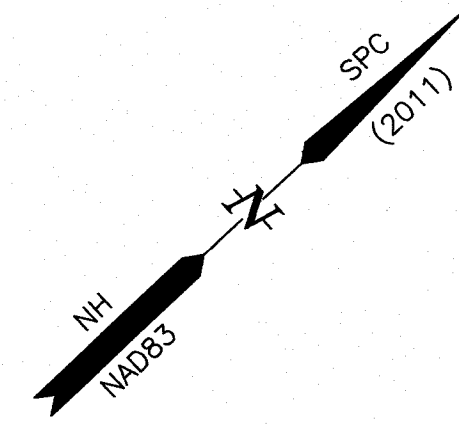

NO.	DESCRIPTION	DATE
2	ISSUED FOR APPROVAL	6/18/18
1	ISSUED FOR CONCEPTUAL REVIEW	3/5/18
0	ISSUED FOR COMMENT	2/12/18

SUBDIVISION PLAN
TAX MAP 157 - LOTS 1 & 2
TAX MAP 164 -
LOTS 1, 2, 3, & 4
OWNER OF RECORD
TAX MAP 157, LOT 2 &
TAX MAP 164, LOTS 1, 2, & 3:
**PORTSMOUTH LUMBER AND
HARDWARE, LLC**
OWNER OF RECORD
TAX MAP 157, LOT 1
CLIPPER TRADERS, LLC
OWNER OF RECORD
TAX MAP 164, LOT 4:
BOSTON AND MAINE CORPORATION
PROPERTY LOCATED AT:
105 BARTLETT STREET
CITY OF PORTSMOUTH
COUNTY OF ROCKINGHAM
STATE OF NEW HAMPSHIRE

APPROVED BY THE PORTSMOUTH PLANNING BOARD

CHAIRMAN _____ DATE _____

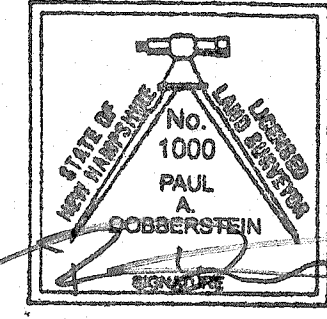
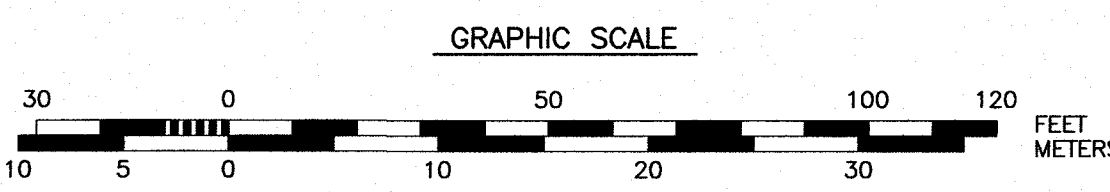

"I CERTIFY THAT THIS PLAN WAS PREPARED UNDER MY DIRECT SUPERVISION, THAT IT IS THE RESULT OF A FIELD SURVEY BY THIS OFFICE AND HAS AN ACCURACY OF THE CLOSED TRAVERSE THAT EXCEEDS THE PRECISION OF 1:15,000."
PAUL A. DOBBERSTEIN, LLS
DATE _____

CURVE TABLE

CURVE	RADIUS	ARC LENGTH	CHORD LENGTH	CHORD BEARING	DELTA ANGLE
C1	60.00'	266.77'	95.37'	S05°48'40"E	254°44'33"
C2	60.00'	185.84'	119.97'	S44°26'53"E	177°28'07"
C3	60.00'	80.92'	74.93'	S82°55'23"W	77°16'26"
C4	35.00'	45.66'	42.49'	S84°11'20"W	74°44'33"
C5	150.00'	38.24'	38.14'	S39°30'52"W	14°36'24"
C6	200.00'	42.87'	42.79'	S38°21'07"W	12°16'55"
C7	25.00'	31.80'	29.70'	S19°56'09"W	72°52'42"
C8	288.61'	48.94'	48.88'	N21°21'40"W	9°42'56"
C9	288.61'	9.89'	9.89'	N00°32'28"E	1°57'48"
C10	288.61'	80.91'	80.65'	N08°28'19"W	16°03'46"

LENGTH TABLE

LINE	BEARING	DISTANCE
L1	S46°54'17"E	11.80'
L2	S46°49'43"E	11.20'
L3	N59°39'51"E	2'±

"I CERTIFY THAT THIS PLAN WAS PREPARED UNDER MY DIRECT SUPERVISION, THAT IT IS THE RESULT OF A FIELD SURVEY BY THIS OFFICE AND HAS AN ACCURACY OF THE CLOSED TRAVERSE THAT EXCEEDS THE PRECISION OF 1:15,000."

PAUL A DOBBERSTEIN, LLS
DATE 6/18/2018

NORTH MILL POND (TIDAL)

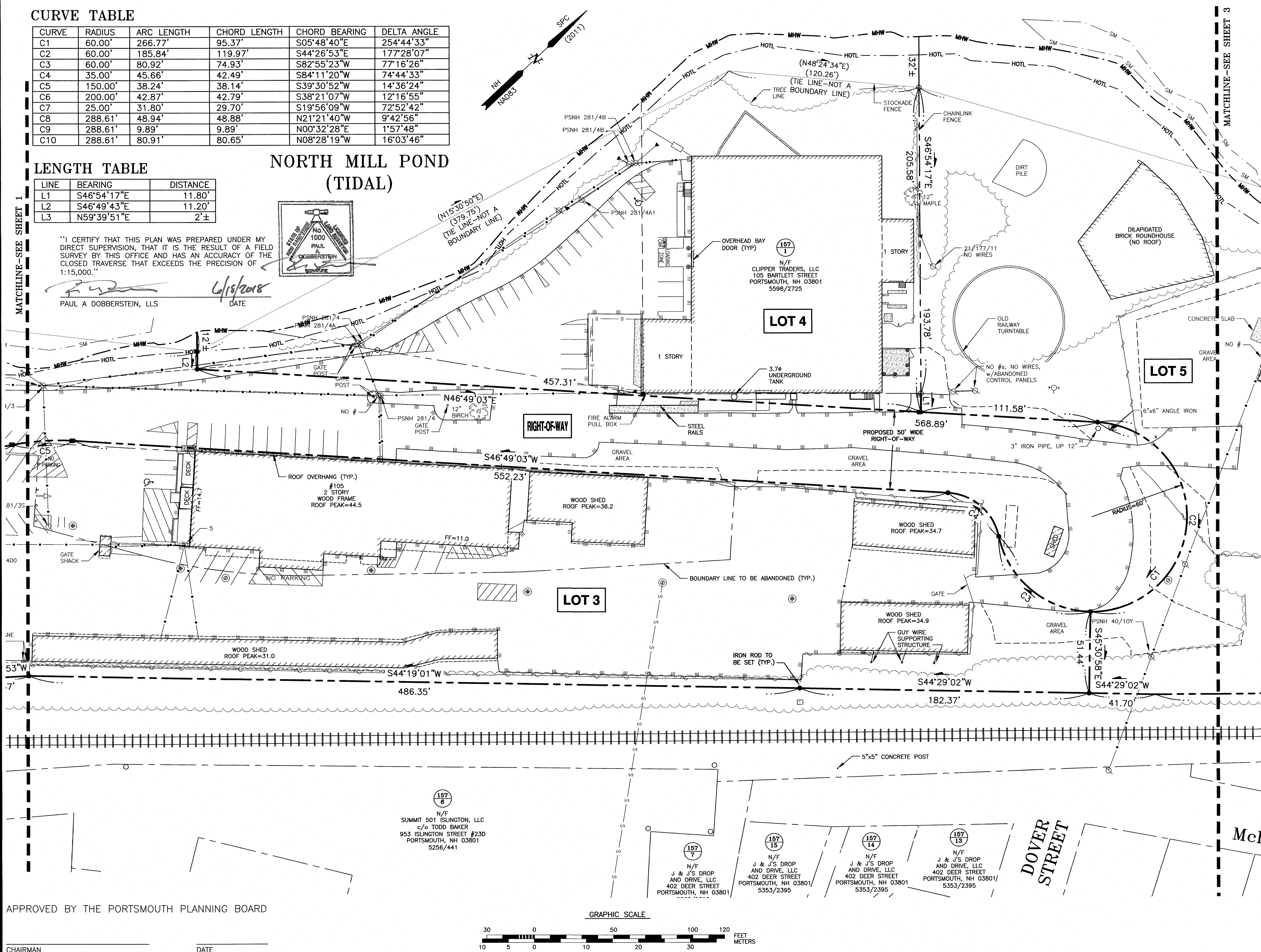
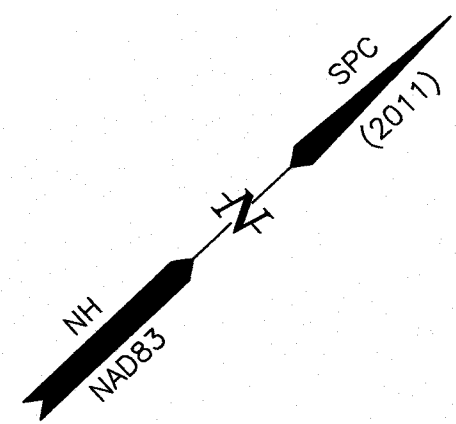
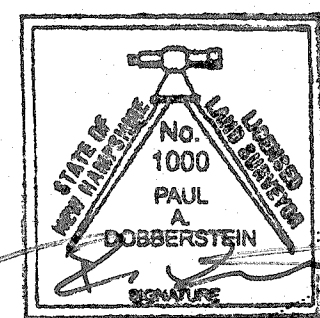

AMBIT ENGINEERING, INC.
Civil Engineers & Land Surveyors
200 Griffin Road - Unit 3
Portsmouth, N.H. 03801-7114
Tel (603) 430-9282
Fax (603) 436-2315

- NOTES:**
- 1) PARCELS ARE SHOWN ON THE CITY OF PORTSMOUTH ASSESSOR'S MAP 157 AS LOTS 1 & 2 AND ASSESSOR'S MAP 164 AS LOTS 1, 2, 3, & 4.
 - 2) PORTIONS OF MAP 157 LOT 1 AND MAP 164 LOT 4 ARE IN A SPECIAL FLOOD HAZARD AREA AS SHOWN ON FIRM PANEL 33015C0259E. EFFECTIVE DATE MAY 17, 2005.
 - 3) PARCELS ARE LOCATED IN CHARACTER DISTRICT 4-W (CD4-W), OFFICE RESEARCH (OR), AND TRANSPORTATION CORRIDOR (TC) ZONING DISTRICTS.
 - 4) THE PURPOSE OF THIS PLAN IS TO SHOW THE CONSOLIDATION AND SUBDIVISION OF THE PARCELS INTO 5 LOTS AND A RIGHT-OF-WAY, AND TO RELOCATE THE LOT LINE OF MAP 164 LOT 4.

NO.	DESCRIPTION	DATE
2	ISSUED FOR APPROVAL	6/18/18
1	ISSUED FOR CONCEPTUAL REVIEW	3/5/18
0	ISSUED FOR COMMENT	2/12/18

SUBDIVISION PLAN
TAX MAP 157 - LOTS 1 & 2
TAX MAP 164 -
LOTS 1, 2, 3, & 4
OWNER OF RECORD
TAX MAP 157, LOT 2 &
TAX MAP 164, LOTS 1, 2, & 3:
PORTSMOUTH LUMBER AND
HARDWARE, LLC
OWNER OF RECORD
TAX MAP 157, LOT 1
CLIPPER TRADERS, LLC
OWNER OF RECORD
TAX MAP 164, LOT 4:
BOSTON AND MAINE CORPORATION
PROPERTY LOCATED AT:
105 BARTLETT STREET
CITY OF PORTSMOUTH
COUNTY OF ROCKINGHAM
STATE OF NEW HAMPSHIRE

APPROVED BY THE PORTSMOUTH PLANNING BOARD

CHAIRMAN _____ DATE _____

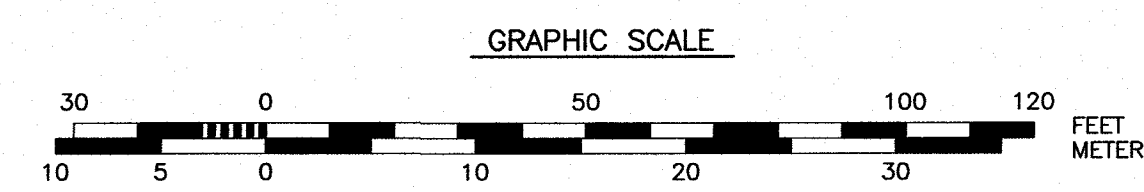

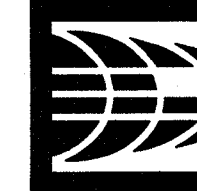

AMBIT ENGINEERING, INC.
Civil Engineers & Land Surveyors

200 Griffin Road - Unit 3
Portsmouth, N.H. 03801-7114
Tel (603) 430-9282
Fax (603) 436-2315

NOTES:

- 1) PARCELS ARE SHOWN ON THE CITY OF PORTSMOUTH ASSESSOR'S MAP 157 AS LOTS 1 & 2 AND ASSESSOR'S MAP 164 AS LOTS 1, 2, 3, & 4.
- 2) PORTIONS OF MAP 157 LOT 1 AND MAP 164 LOT 4 ARE IN A SPECIAL FLOOD HAZARD AREA AS SHOWN ON FIRM PANEL 33015C0259E. EFFECTIVE DATE MAY 17, 2005.
- 3) PARCELS ARE LOCATED IN CHARACTER DISTRICT 4-W (CD4-W), OFFICE RESEARCH (OR), AND TRANSPORTATION CORRIDOR (TC) ZONING DISTRICTS.
- 4) THE PURPOSE OF THIS PLAN IS TO SHOW THE CONSOLIDATION AND SUBDIVISION OF THE PARCELS INTO 5 LOTS AND A RIGHT-OF-WAY, AND TO RELOCATE THE LOT LINE OF MAP 164 LOT 4.

**NORTH MILL POND
(TIDAL)**

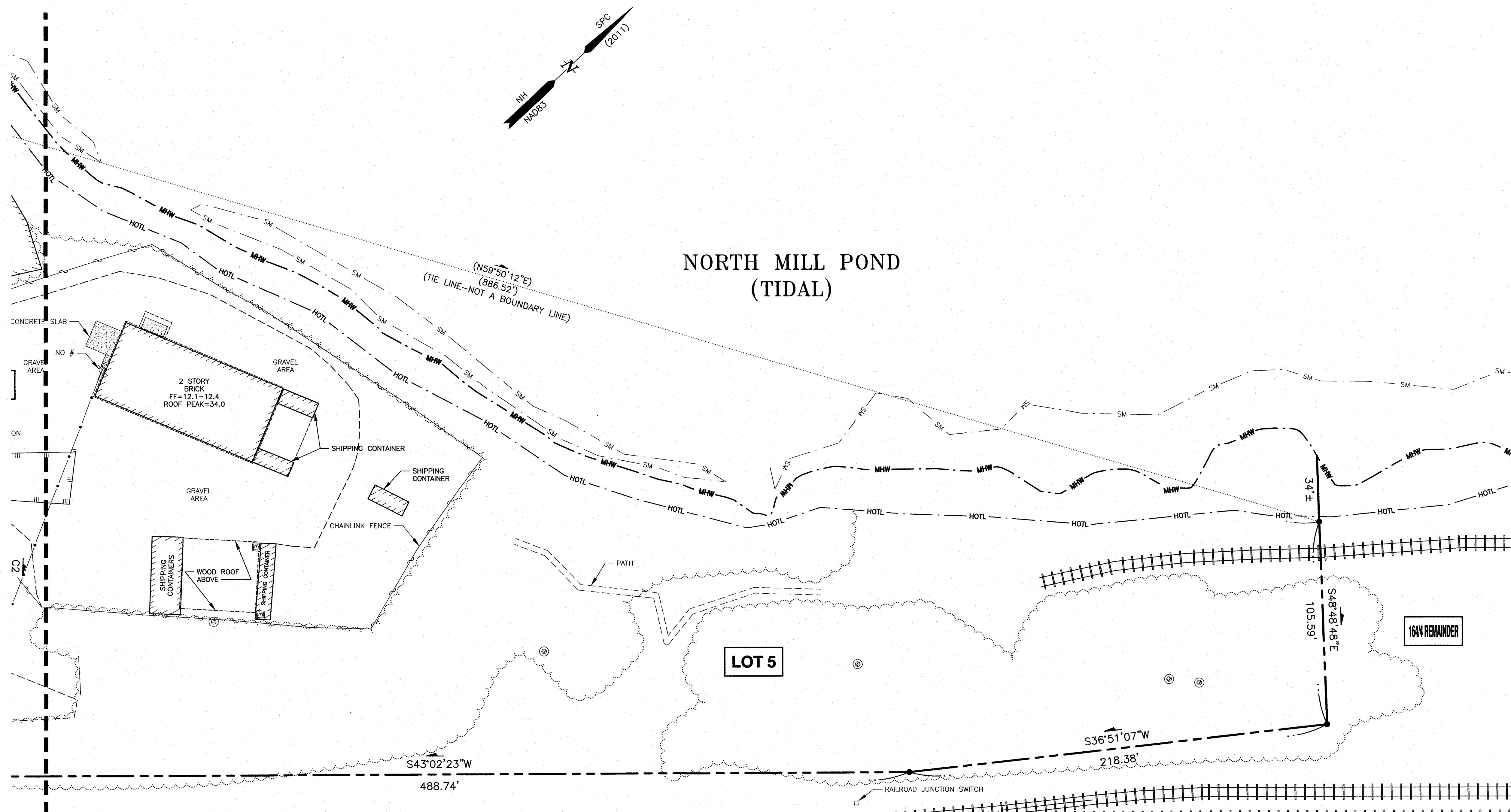

NO.	DESCRIPTION	DATE
2	ISSUED FOR APPROVAL	6/18/18
1	ISSUED FOR CONCEPTUAL REVIEW	3/5/18
0	ISSUED FOR COMMENT	2/12/18

SUBDIVISION PLAN
TAX MAP 157 - LOTS 1 & 2
TAX MAP 164 -
LOTS 1, 2, 3, & 4
OWNER OF RECORD
TAX MAP 157, LOT 2 &
TAX MAP 164, LOTS 1, 2, & 3:
PORTSMOUTH LUMBER AND
HARDWARE, LLC
OWNER OF RECORD
TAX MAP 157, LOT 1
CLIPPER TRADERS, LLC
OWNER OF RECORD
TAX MAP 164, LOT 4:
BOSTON AND MAINE CORPORATION
PROPERTY LOCATED AT:
105 BARTLETT STREET
CITY OF PORTSMOUTH
COUNTY OF ROCKINGHAM
STATE OF NEW HAMPSHIRE

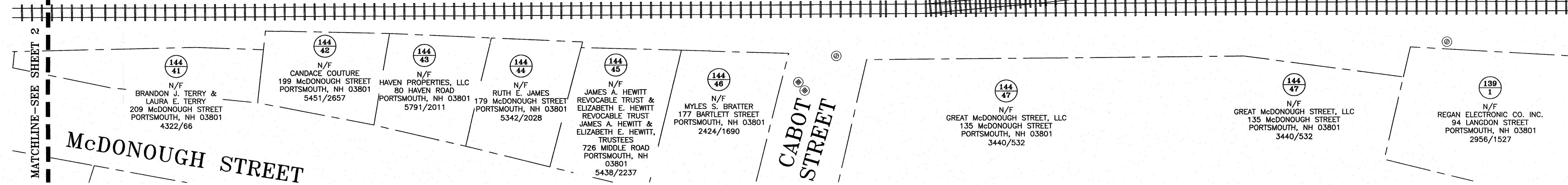

APPROVED BY THE PORTSMOUTH PLANNING BOARD

CHAIRMAN _____ DATE _____

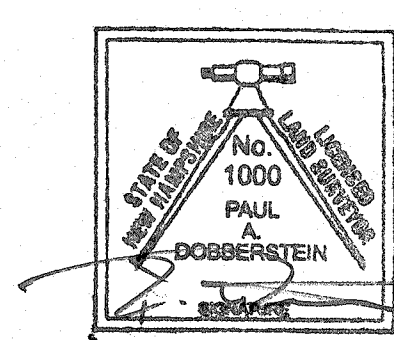
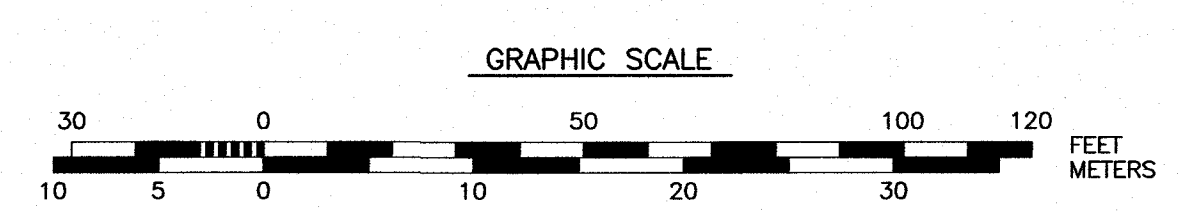

"I CERTIFY THAT THIS PLAN WAS PREPARED UNDER MY DIRECT SUPERVISION, THAT IT IS THE RESULT OF A FIELD SURVEY BY THIS OFFICE AND HAS AN ACCURACY OF THE CLOSED TRAVERSE THAT EXCEEDS THE PRECISION OF 1:15,000."
PAUL A. DOBBERSTEIN, LLS
DATE 6/18/2018

- NOTES:**
- 1) PARCELS ARE SHOWN ON THE CITY OF PORTSMOUTH ASSESSOR'S MAP 157 AS LOTS 1 & 2 AND ASSESSOR'S MAP 16 AS LOTS 1, 2, 3, & 4.
 - 2) PORTIONS OF MAP 157 LOT 1 AND MAP 164 LOT 4 ARE IN A SPECIAL FLOOD HAZARD AREA AS SHOWN ON FIRM PANEL 33015C0259E. EFFECTIVE DATE MAY 17, 2005.
 - 3) THE PURPOSE OF THIS PLAN IS TO SHOW THE EXISTING CONDITIONS ON THE PARCELS.
 - 4) VERTICAL DATUM IS MEAN SEA LEVEL NAVD88. BASIS OF VERTICAL DATUM IS REDUNDANT RTN GPS OBSERVATIONS (±0.3').
 - 5) HORIZONTAL DATUM AND BASIS OF BEARINGS IS THE NH STATE PLANE COORDINATE SYSTEM NAD 83 (2011). BASIS OF HORIZONTAL DATUM IS REDUNDANT RTN GPS OBSERVATIONS.

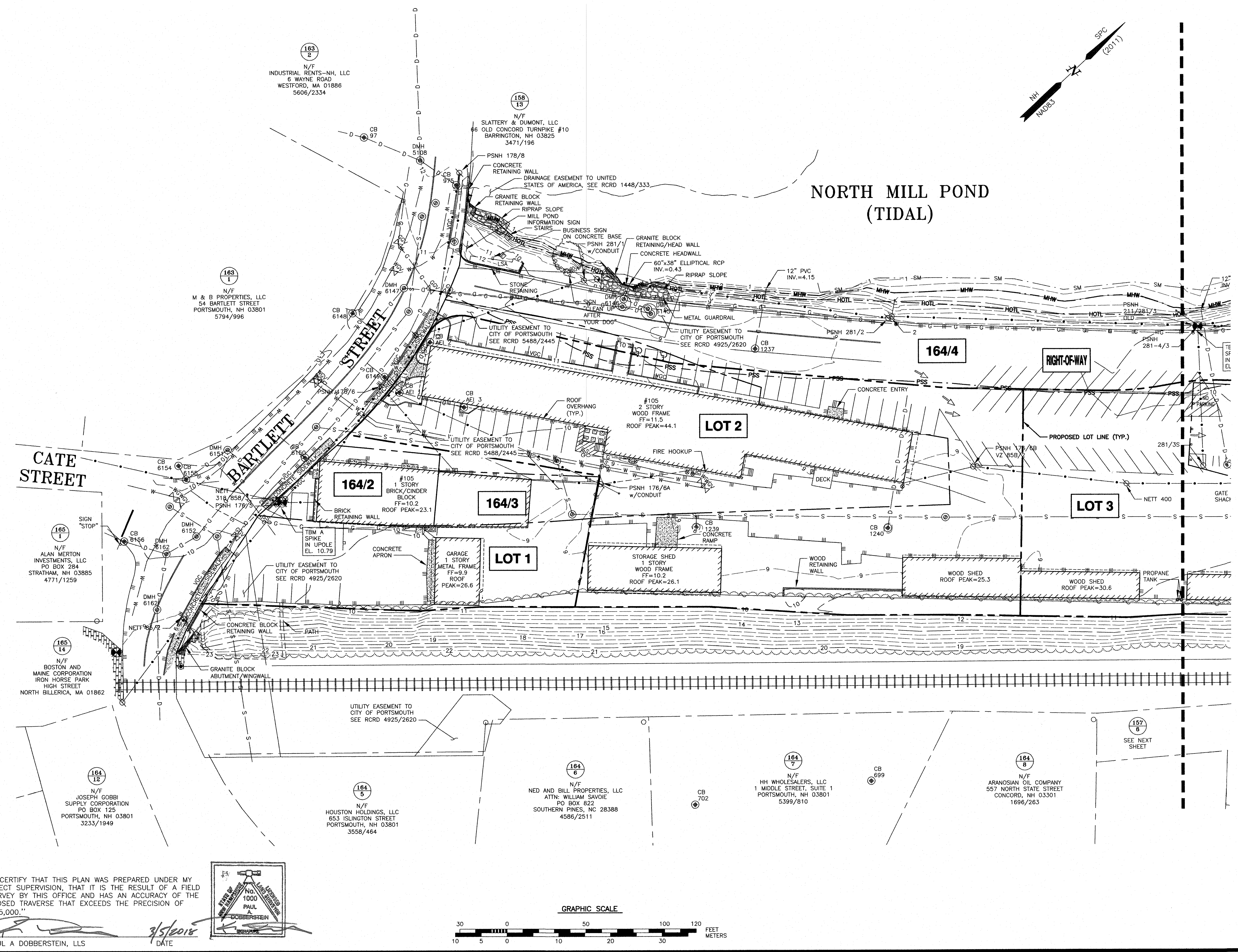

**SUBDIVISION PLAN
CLIPPER TRADERS, LLC
OFF BARTLETT STREET
PORTSMOUTH, N.H.**

1	ISSUED FOR CONCEPTUAL REVIEW	3/5/18
0	ISSUED FOR COMMENT	2/12/18
NO.	DESCRIPTION	DATE

REVISIONS

SCALE 1"=30' FEBRUARY 2018

EXISTING CONDITIONS PLAN **C1**

"I CERTIFY THAT THIS PLAN WAS PREPARED UNDER MY DIRECT SUPERVISION, THAT IT IS THE RESULT OF A FIELD SURVEY BY THIS OFFICE AND HAS AN ACCURACY OF THE CLOSED TRAVERSE THAT EXCEEDS THE PRECISION OF 1:15,000."

PAUL A DOBBERSTEIN, LLS
DATE 2/5/2018

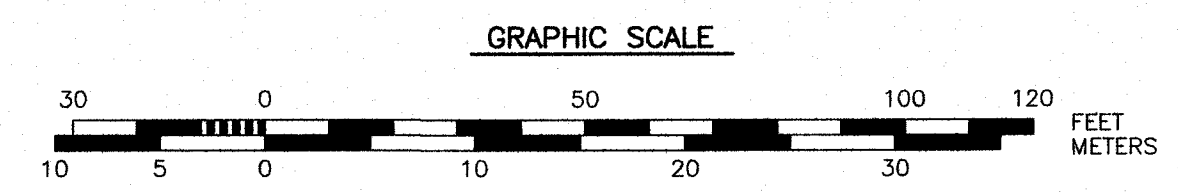
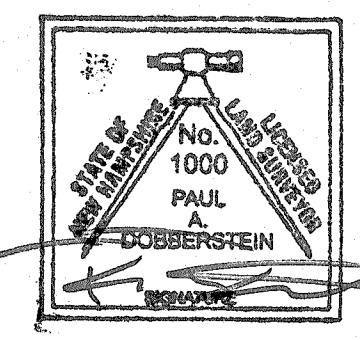



AMBIT ENGINEERING, INC.
Civil Engineers & Land Surveyors

200 Griffin Road - Unit 3
Portsmouth, N.H. 03801-7114
Tel (603) 430-9282
Fax (603) 438-2315

NOTES:

- 1) PARCELS ARE SHOWN ON THE CITY OF PORTSMOUTH ASSESSOR'S MAP 157 AS LOTS 1 & 2 AND ASSESSOR'S MAP 16 AS LOTS 1, 2, 3, & 4.
- 2) PORTIONS OF MAP 157 LOT 1 AND MAP 164 LOT 4 ARE IN A SPECIAL FLOOD HAZARD AREA AS SHOWN ON FIRM PANEL 33015C0259E. EFFECTIVE DATE MAY 17, 2005.
- 3) THE PURPOSE OF THIS PLAN IS TO SHOW THE EXISTING CONDITIONS ON THE PARCELS.
- 4) VERTICAL DATUM IS MEAN SEA LEVEL NAVD88. BASIS OF VERTICAL DATUM IS REDUNDANT RTN GPS OBSERVATIONS (±0.3').
- 5) HORIZONTAL DATUM AND BASIS OF BEARINGS IS THE NH STATE PLANE COORDINATE SYSTEM NAD 83 (2011). BASIS OF HORIZONTAL DATUM IS REDUNDANT RTN GPS OBSERVATIONS.

NORTH MILL POND (TIDAL)

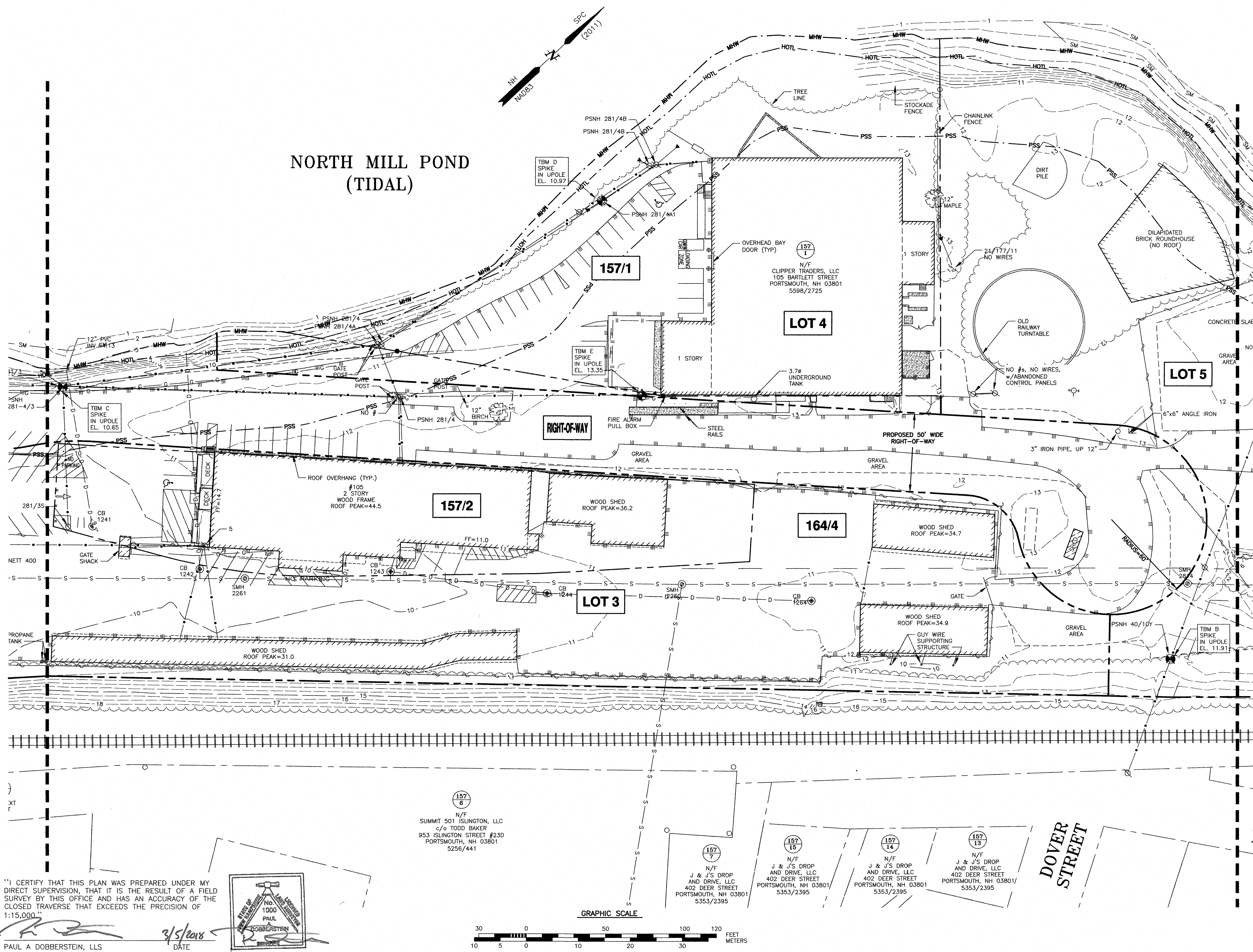

SUBDIVISION PLAN CLIPPER TRADERS, LLC OFF BARTLETT STREET PORTSMOUTH, N.H.

NO.	DESCRIPTION	DATE
1	ISSUED FOR CONCEPTUAL REVIEW	3/5/18
0	ISSUED FOR COMMENT	2/12/18

REVISIONS		

SCALE 1"=30' FEBRUARY 2018

EXISTING CONDITIONS PLAN **C2**

"I CERTIFY THAT THIS PLAN WAS PREPARED UNDER MY DIRECT SUPERVISION, THAT IT IS THE RESULT OF A FIELD SURVEY BY THIS OFFICE AND HAS AN ACCURACY OF THE CLOSED TRAVERSE THAT EXCEEDS THE PRECISION OF 1:15,000.

3/5/2018
DATE

PAUL A DOBBERSTEIN, LLS

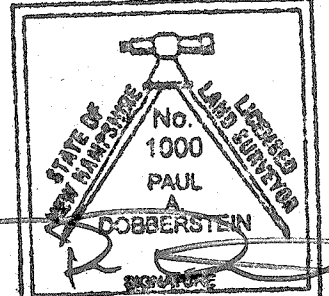

157 8
N/F
SUMMIT 501 ISLINGTON, LLC
c/o TODD BAKER
953 ISLINGTON STREET #230
PORTSMOUTH, NH 03801
5256/441

157 7
N/F
J & J'S DROP
AND DRIVE, LLC
402 DEER STREET
PORTSMOUTH, NH 03801
5353/2395

157 18
N/F
J & J'S DROP
AND DRIVE, LLC
402 DEER STREET
PORTSMOUTH, NH 03801
5353/2395

157 14
N/F
J & J'S DROP
AND DRIVE, LLC
402 DEER STREET
PORTSMOUTH, NH 03801
5353/2395

157 13
N/F
J & J'S DROP
AND DRIVE, LLC
402 DEER STREET
PORTSMOUTH, NH 03801
5353/2395

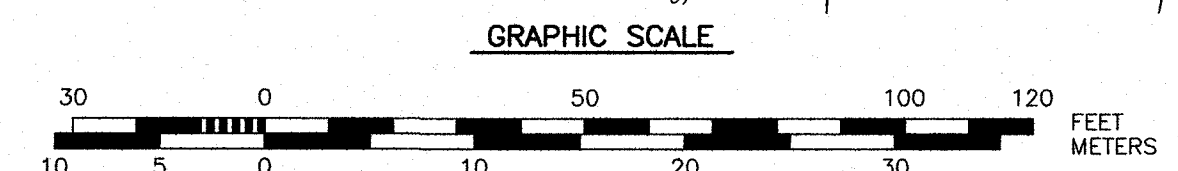



AMBIT ENGINEERING, INC.
Civil Engineers & Land Surveyors

200 Griffin Road - Unit 3
Portsmouth, N.H. 03801-7114
Tel (603) 430-9282
Fax (603) 436-2315

NOTES:

- 1) PARCELS ARE SHOWN ON THE CITY OF PORTSMOUTH ASSESSOR'S MAP 157 AS LOTS 1 & 2 AND ASSESSOR'S MAP 16 AS LOTS 1, 2, 3, & 4.
- 2) PORTIONS OF MAP 157 LOT 1 AND MAP 164 LOT 4 ARE IN A SPECIAL FLOOD HAZARD AREA AS SHOWN ON FIRM PANEL 33015C0259E. EFFECTIVE DATE MAY 17, 2005.
- 3) THE PURPOSE OF THIS PLAN IS TO SHOW THE EXISTING CONDITIONS ON THE PARCELS.
- 4) VERTICAL DATUM IS MEAN SEA LEVEL NAVD88. BASIS OF VERTICAL DATUM IS REDUNDANT RTN GPS OBSERVATIONS ($\pm 0.3'$).
- 5) HORIZONTAL DATUM AND BASIS OF BEARINGS IS THE NH STATE PLANE COORDINATE SYSTEM NAD 83 (2011). BASIS OF HORIZONTAL DATUM IS REDUNDANT RTN GPS OBSERVATIONS.

NORTH MILL POND (TIDAL)

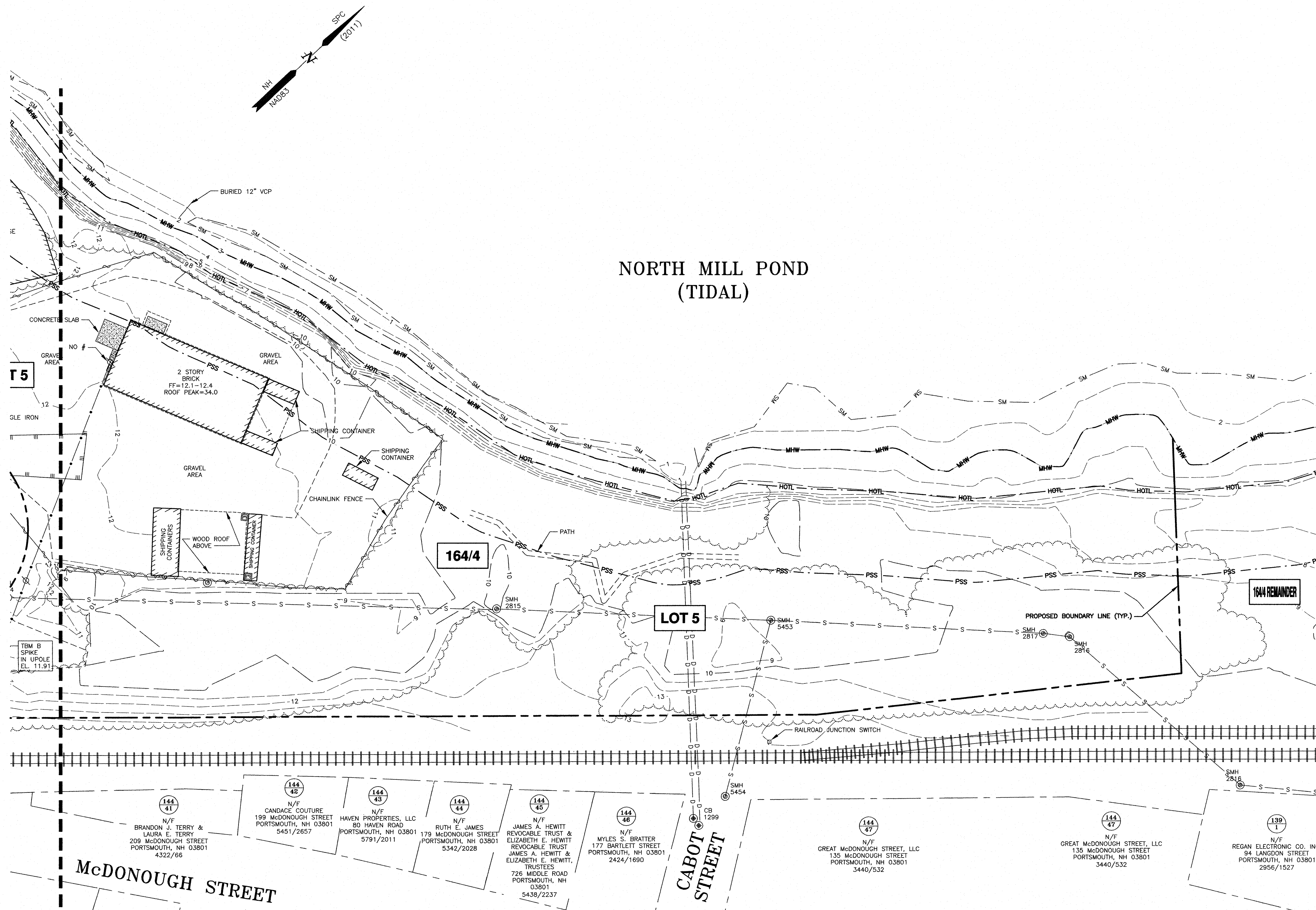

SUBDIVISION PLAN CLIPPER TRADERS, LLC OFF BARTLETT STREET PORTSMOUTH, N.H.

NO.	DESCRIPTION	DATE
1	ISSUED FOR CONCEPTUAL REVIEW	3/5/18
0	ISSUED FOR COMMENT	2/12/18

REVISIONS	

SCALE 1"=30' FEBRUARY 2018

EXISTING CONDITIONS PLAN **C3**

"I CERTIFY THAT THIS PLAN WAS PREPARED UNDER MY DIRECT SUPERVISION, THAT IT IS THE RESULT OF A FIELD SURVEY BY THIS OFFICE AND HAS AN ACCURACY OF THE CLOSED TRAVERSE THAT EXCEEDS THE PRECISION OF 1:15,000."

PAUL A. DOBBERSTEIN
PAUL A. DOBBERSTEIN, LLS
DATE 3/5/2018

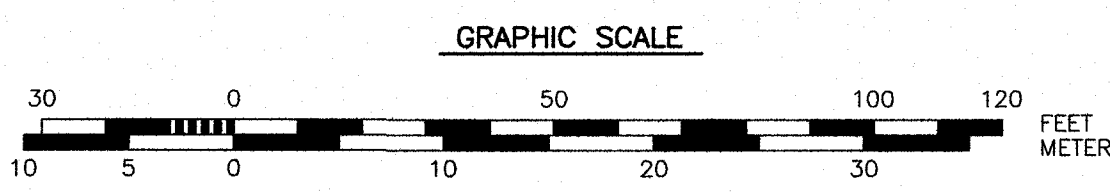
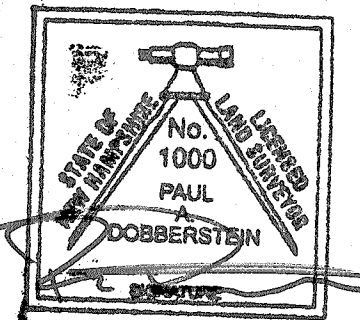

TRAFFIC IMPACT AND SITE ACCESS STUDY

PROPOSED RESIDENTIAL SUBDIVISION

Portsmouth, New Hampshire

June 2018

Prepared for

Clipper Traders, LLC



**Stephen G. Pernaw
& Company, Inc.**

**TRAFFIC IMPACT AND SITE ACCESS STUDY
PROPOSED RESIDENTIAL DEVELOPMENT
PORTSMOUTH, NEW HAMPSHIRE
June 18, 2018**

INTRODUCTION

This Traffic Impact and Site Access Study has been prepared for Clipper Traders, LLC in order to assess the traffic impacts associated with the proposed residential subdivision and development located on the south side of North Mill Pond, at the former site of the Boston & Maine Railroad Yard in Portsmouth, New Hampshire. The City of Portsmouth has required this study in conjunction with the proposed zoning change and Site Plan Review process. This report is intended to summarize the data collected, the future traffic projections, the technical analyses and our findings and recommendations relative to traffic operations, capacity, and safety in the study area.

PROPOSAL

The proposed development consists of several parcels (Tax Map 157, Lots 1 and 2; and Tax Map 164, Lots 1, 2, 3, and 4) which will be consolidated and then subdivided into five separate lots. The current proposal calls for the construction of six free-standing buildings with four to forty dwelling units per building. This area currently lies within the office research zone (OR) and a zoning change to character-based zoning (CD4-W) is being sought.

Vehicular access to the development will be provided via the existing shared driveway on the north side of Bartlett Street that currently provides access to Ricci Lumber, Great Rhythm Brewing Company and other commercial entities.

Figure 1 shows the location of the proposed residential subdivision with respect to the area roadway system. Appendix A contains a preliminary concept plan that is the subject of this assessment.

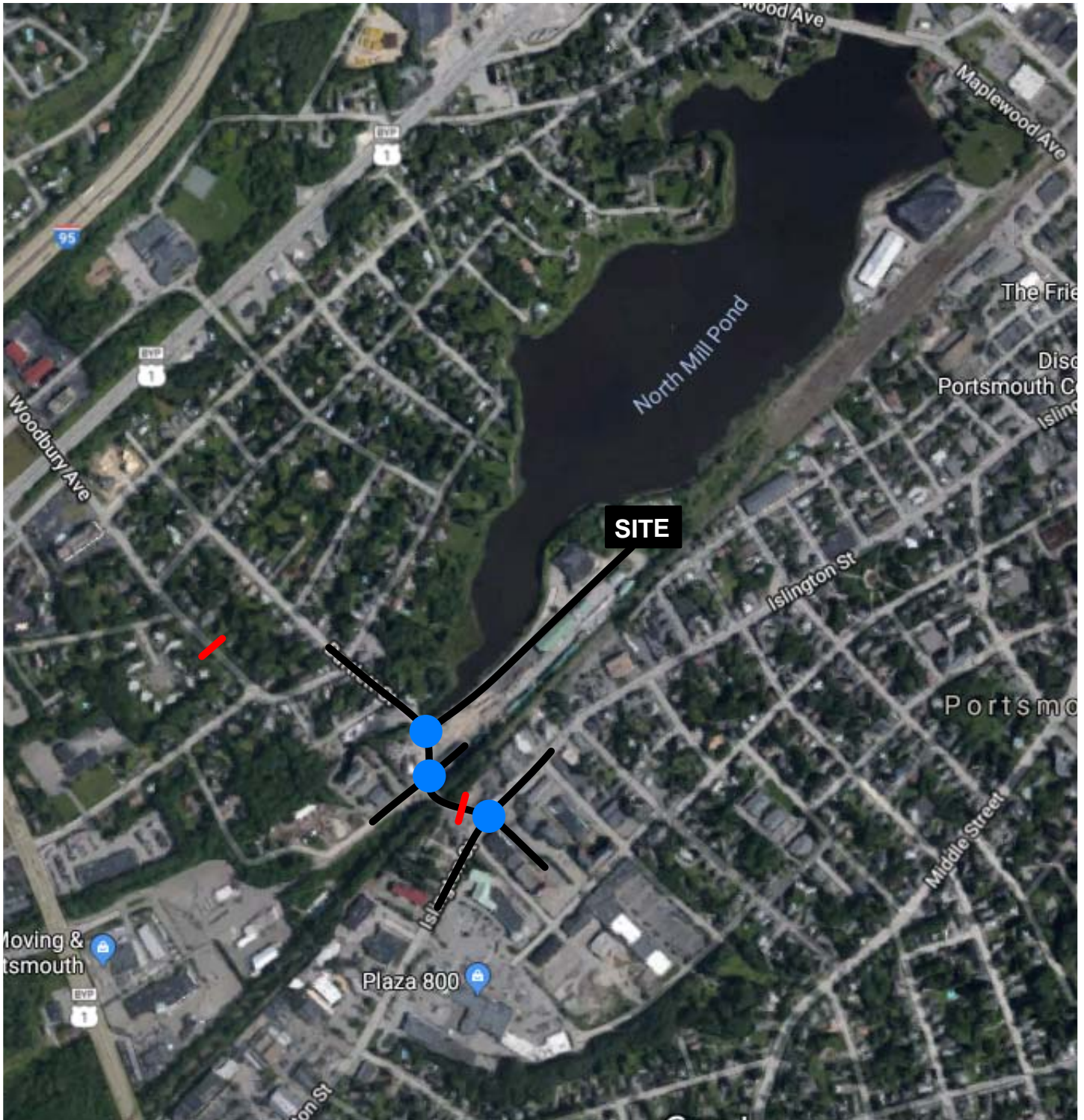

 = AUTOMATIC TRAFFIC RECORDER LOCATION (NHDOT)

 = TURNING MOVEMENT COUNT LOCATIONS



1821A

Figure 1

Site Location

Traffic Impact and Site Access Study, Proposed Residential Development, Portsmouth, New Hampshire

EXISTING CONDITIONS

ROADWAYS

The **Existing Shared Driveway** functions as a two-lane private dead-end street with a general southwest to northeast orientation in the study area. The roadway is delineated with single white edge lines and a worn 4-inch double yellow centerline. It provides access to customers of Ricci Lumber, Ace Hardware, Great Rhythm Brewing Company and a dog care facility. The horizontal alignment of the driveway is essentially straight and the vertical alignment is flat. Ninety-degree on-street parking is provided along the east side of this driveway for the Ricci Lumber business. A 10 mph speed limit sign is posted on this driveway, facing inbound vehicles.

Bartlett Street functions as a local collector road with a general northwest to southeast orientation in the study area; it carries through vehicles between Islington Street and Woodbury Avenue via Dennett Street and Thornton Street. Abutting land uses in the area range from residential to commercial. The horizontal alignment of the roadway is curvilinear and the vertical alignment is essentially flat in the immediate study area. A paved sidewalk is present in most places along both sides of the roadway. The speed limit is posted at 20 mph in both directions.

Cate Street functions as a local collector road with a general north to south direction from its origin at Cottage Street to a sharp corner to the left and then an “S”-curve in its alignment heading to the east where it terminates at Bartlett Street. The horizontal alignment of the roadway is curvilinear and the vertical alignment ranges from flat to rolling in the area. There are no paved sidewalks or speed limit signs along Cate Street.

Islington Street functions as an urban arterial roadway with a general southwest to northeast orientation in the study area; it carries through vehicles between NH Route 33 and downtown Portsmouth. The horizontal alignment of the roadway is curvilinear and the vertical alignment is essentially flat in the study area. Islington Street provides access to numerous commercial sites and retail businesses, as well as many residences. A paved sidewalk is present along both sides of the roadway.

INTERSECTIONS

The **Bartlett Street/Existing Shared Driveway** intersection functions as a typical three-leg “T” intersection and the Existing Shared Driveway approach does not operate under traffic signal control (no stop sign, no stop line). The approach lanes are designated accordingly:

- SB: One shared left-right lane
- WB: One shared through-right lane
- EB: One shared left-through lane

As noted previously, ninety-degree parking stalls for Ricci Lumber business are located adjacent to this intersection, on the east side of the shared driveway. There are no marked crosswalks at this intersection.

The **Bartlett Street/Cate Street** intersection functions as a typical three-leg “T” intersection; however there is an existing parking lot driveway located across from Cate Street that was not utilized during the traffic count periods. The Cate Street approach currently operates under STOP sign control. The existing lane configuration at this intersection is delineated as follows:

- NB: One shared left-right lane
- WB: One shared left-through lane
- EB: One shared through-right lane

Although not formally designated with two approach lanes, the Cate Street approach to Bartlett Street is flared to the extent that left and right turning vehicles are able to queue side-by-side on occasion. Crosswalks are not present at this intersection.

The **Islington Street/Bartlett Street/Pharmacy Driveway** intersection functions as a four-leg intersection that operates under traffic signal control. The signal heads are currently post-mounted or span wire-mounted. The existing lane configuration at this intersection is delineated as follows:

- EB: One shared left-through lane, one exclusive right-turn lane
- WB: One shared left-through-right lane
- NB: One exclusive left-turn lane, one shared through-right lane
- SB: One shared left-through lane, one exclusive right-turn lane

This traffic signal utilizes a fully-actuated controller that operates with three basic signal phases and an exclusive pedestrian phase (when actuated): 1) the Islington Street southbound approach (with permitted left turns) and northbound through-right movements, 2) Islington Street northbound left turns (lagging phase) with northbound through-right movements, and then 3) the Bartlett Street and pharmacy driveway approaches run concurrently. This controller operated with an 82-second (AM) and 90-second (PM) average cycle length during the peak hour periods.

Three crosswalks are present and extend across the southbound, westbound and eastbound approaches. The exclusive pedestrian phase was utilized only occasionally during the peak hour periods.

TRAFFIC VOLUMES

Research at the New Hampshire Department of Transportation (NHDOT) revealed that short-term automatic traffic recorder counts were conducted on Bartlett Street (west of Islington Street) in September of 2017 and Woodbury Ave (north of Cottage Street) in September of 2016. These count stations are located a short distance west and east of the subject site.

The NHDOT data shows that Bartlett Street (south of the subject site) carried an Annual Average Daily Traffic (AADT) volume of 16,414 vpd in 2017, down from 17,860 vpd in 2016. Woodbury Avenue carried approximately 6,277 vpd in 2017, up slightly from 6,154 vpd in 2016. Data from the automatic traffic recorder counts is summarized graphically on Page 7. This data demonstrates that traffic demand consistently reaches peak levels during weekday evening commuter period. Appendix B contains a summary of the NHDOT count data.

To establish current travel patterns and traffic volumes in the study area, Pernaw & Company, Inc. simultaneously conducted turning movement and vehicle classification counts on a weekday morning and afternoon in April 2018 at the three study area intersections. These counts were conducted on Thursday, April 5th from 7:00 to 9:00 AM and from 3:00 to 6:00 PM. The new 2018 count data for the study area is summarized on Figure 2. Several facts and conclusions are evident from this data.

- At the **Bartlett Street/Existing Shared Driveway** intersection, the traffic flow reached peak levels from 7:30 to 8:30 AM and from 4:45 to 5:45 PM. Bartlett Street (west of the Shared Driveway) carried 807 (AM) and 1,081 (PM) vehicles during the peak hour periods and the majority (57%) traveled in the eastbound direction during both periods. Truck traffic accounted for approximately 4-percent (AM) and 1-percent (PM) of the traffic flow entering the Bartlett Street/Existing Shared Driveway intersection during these peak hour periods.

The existing Shared Driveway accommodated 166 (AM) and 120 (PM) vehicles during the peak hour periods. The heavier directional flow was inbound during the AM peak hour (57%) and outbound during the PM peak hour (57%).

Although there are no crosswalks at this intersection, the pedestrian count revealed that eight persons were observed crossing the Shared Driveway approach to Bartlett Street during the AM and PM peak hour periods.

- At the **Bartlett Street/Cate Street** intersection, the traffic flow reached peak levels from 8:00 to 9:00 AM and from 4:45 AM to 5:45 PM. This intersection accommodated 964 (AM) and 1,211 (PM) vehicles during these periods. Cate Street carried 164 (AM) and 166 (PM) vehicles during the peak hour periods. The predominant turning movement patterns were between points east on Bartlett Street and points south on Cate Street. Truck traffic accounted for approximately 3-percent (AM) and 1-percent (PM) of the traffic flow entering the Bartlett Street/Cate Street intersection during the peak hour periods.

The pedestrian count revealed that 24 persons were observed crossing the various approaches during the AM and PM peak hour periods (no crosswalks present).

- At the **Islington Street/Bartlett Street/Pharmacy Driveway** intersection, the traffic flow reached peak levels from 7:45 to 8:45 AM and 4:45 to 5:45 PM. This intersection accommodated 1,327 (AM) and 1,758 (PM) vehicles during the peak hour periods. Bartlett Street accommodated 914 (AM) and 1,154 (PM) vehicles during the peak hour periods. Similarly, the Pharmacy Driveway accommodated 51 (AM) and 90 (PM) vehicles. Truck traffic accounted for approximately 3-percent (AM) and 1-percent (PM) of the traffic flow entering the Islington Street/Bartlett Street/Pharmacy Driveway intersection during the peak hour periods.

Crosswalks are present and extend across the southbound, westbound and eastbound approaches. During the AM and PM peak hour periods, a total of 13 persons were observed crossing the southbound approach, 68 persons were observed crossing the westbound approach and four persons were observed crossing the eastbound approach. No one was observed crossing the Islington Street northbound approach (no crosswalk present).

The detail sheets summarizing the raw turning movement count data are included in Appendix C. This new count data is summarized on Figure 2.

DAILY TRAFFIC VARIATIONS

Portsmouth, NH - Bartlett St (West of Islington St) - September 2017
 Portsmouth, NH - Woodbury Ave (North of Cottage St) - September 2016

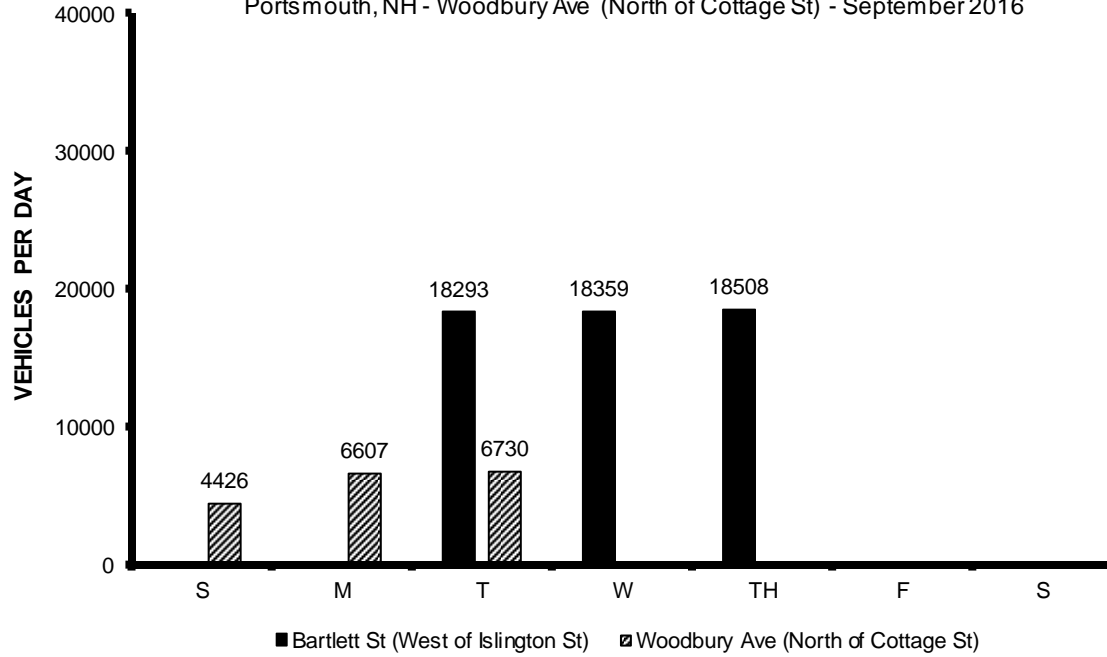

HOURLY TRAFFIC VARIATIONS

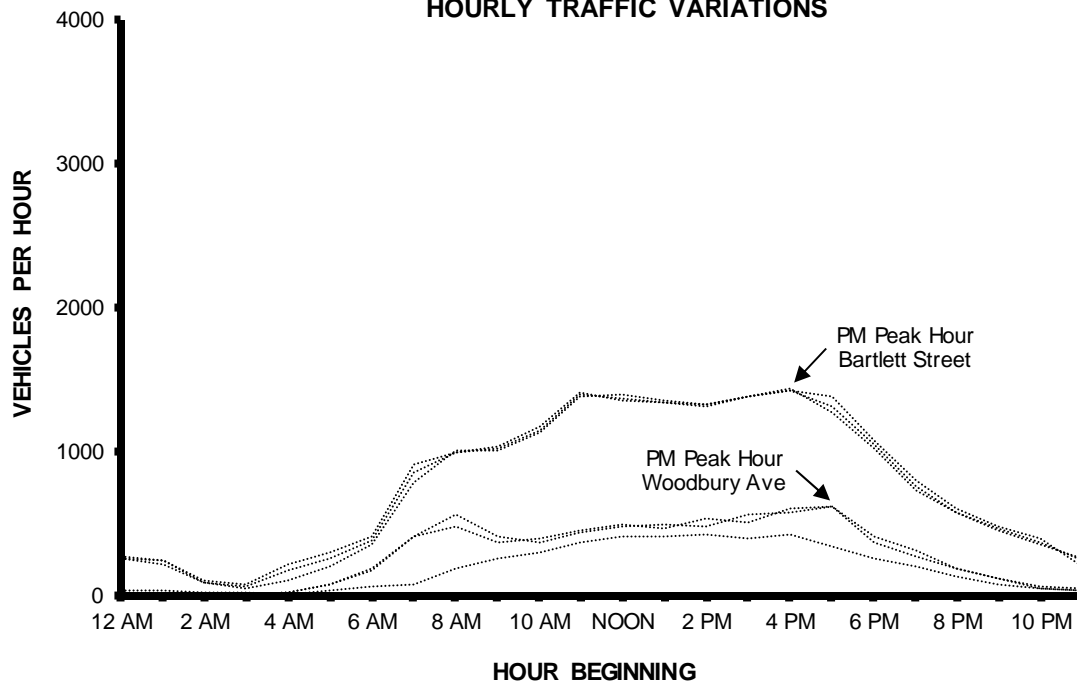

AM Peak Hour
Thursday, April 5, 2018
 7:30 - 8:30 AM
 7:45 - 8:45 AM
 8:00 - 9:00 AM

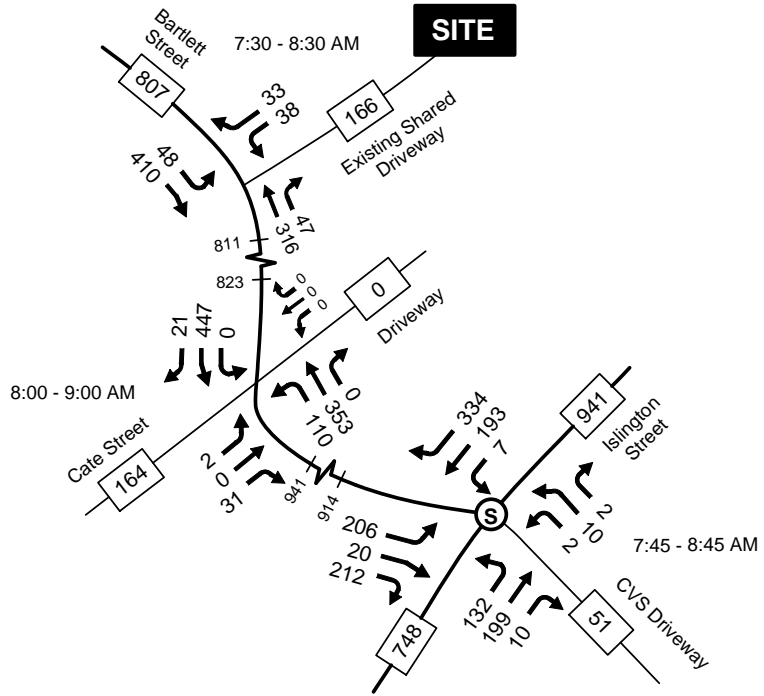

PM Peak Hour
Thursday, April 5, 2018
 4:45 - 5:45 PM

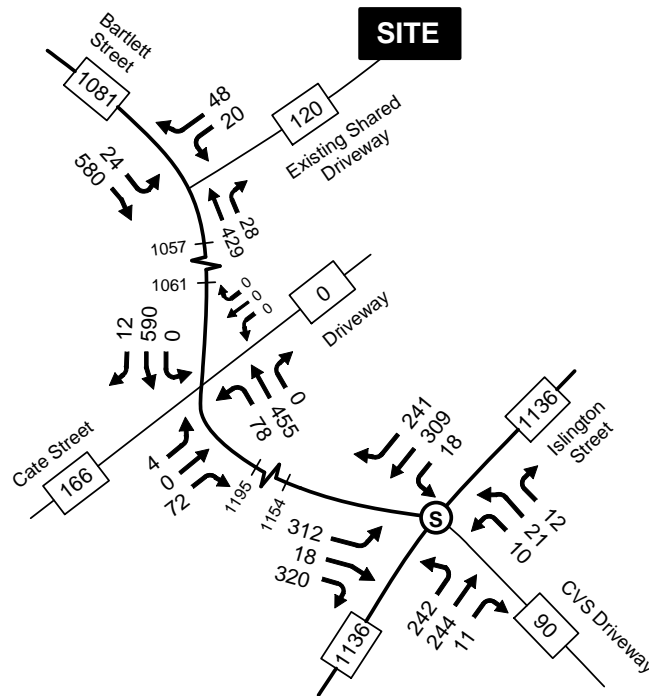

Figure 2

2018 Existing Traffic Volumes

Traffic Impact and Site Access Study, Proposed Residential Subdivision, Portsmouth, New Hampshire

NO-BUILD TRAFFIC VOLUMES

In order to identify the net impact that the proposed residential development will have in the study area, future traffic projections with and without the proposed residential development are necessary. The future traffic projections without the proposed development are referred to as “No-Build” traffic projections.

The No-Build traffic volumes for 2020 and 2030 are summarized schematically on Figure 3 and Figure 4. These projections are based on the April 2018 traffic volumes, a 1-percent annual background traffic growth rate (compounded annually) to account for normal growth in the area, and peak-month seasonal adjustment factors of 1.03 (AM) and 1.04 (PM).

The No-Build projections also account for four other pending development projects that were identified at the “scope meeting” that was conducted with city staff.

- Proposed Multi-Family Development – new 31-unit townhouse development on Cate Street, Portsmouth, NH
- Proposed Subdivision Road – new road to connect Borthwick Avenue and Islington Street in Portsmouth, NH
- Proposed Apartments – new 92-unit apartment development at 145 Brewery Lane, Portsmouth, NH
- Proposed Mixed-Use Development – new mixed-use development at 110 Brewery Lane, Portsmouth, NH

These traffic projections are intended to reflect worst-case, peak-month, peak-hour conditions. Calculations pertaining to the derivation of the annual background traffic growth rate and the seasonal adjustment factors are contained in Appendix D. Appendix E contains the diagrams for the four other development projects.

AM Peak Hour

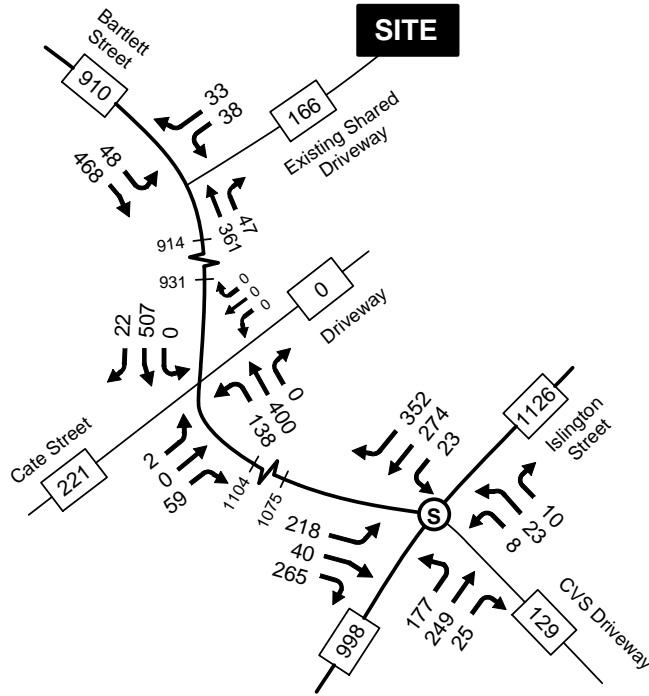

PM Peak Hour

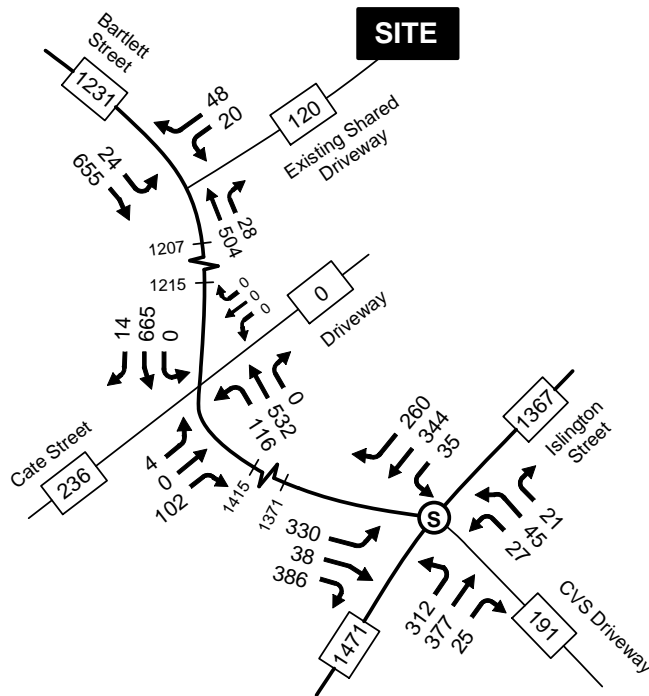
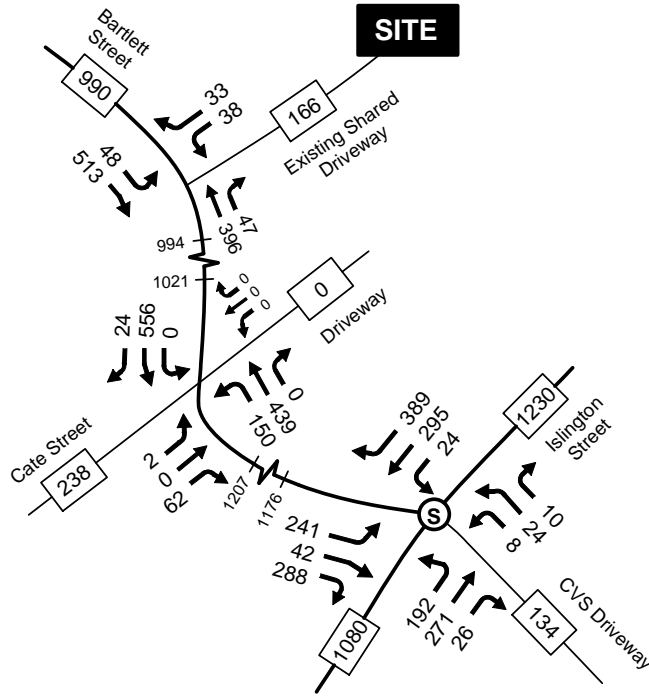

Figure 3

2020 No-Build Traffic Volumes

Traffic Impact and Site Access Study, Proposed Residential Subdivision, Portsmouth, New Hampshire

AM Peak Hour



PM Peak Hour

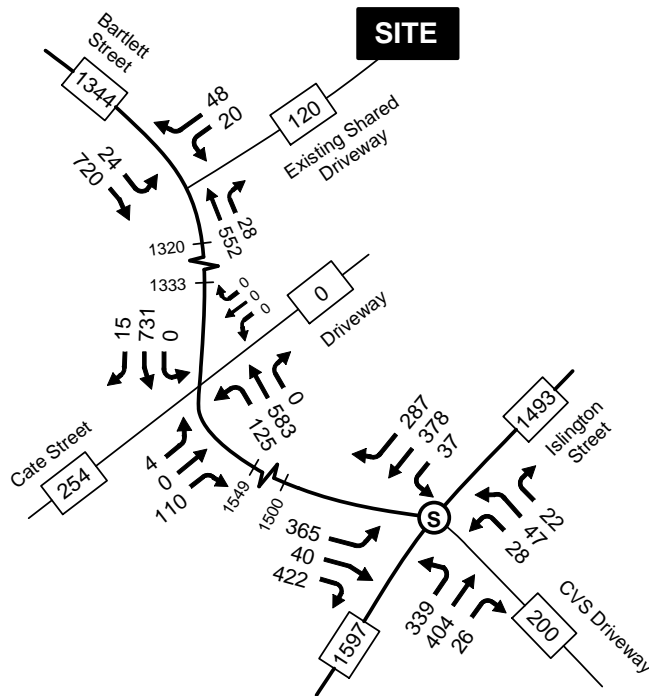

Figure 4

2030 No-Build Traffic Volumes

Traffic Impact and Site Access Study, Proposed Residential Subdivision, Portsmouth, New Hampshire

TRIP GENERATION

To estimate the quantity of vehicle trips that will be produced by the proposed residential development, Pernaw & Company, Inc. considered the standardized trip-generation rates and equations published by the Institute of Transportation Engineers (ITE)¹. Based upon ITE Land Use Code LUC 221 – Multi-Family Housing (Mid-Rise) the overall development is expected to generate approximately 41 vehicle-trips during the weekday AM peak hour and 53 vehicle-trips during the weekday PM peak hour, on an average weekday basis. These results are based upon consideration of both the trip “rate” and “equation” method, and 120 dwelling units as the independent variable. The following table summarizes the anticipated trip-generating characteristics of the proposed residential development.

Table 1		Trip Generation Summary - Clipper Traders	
		120 Dwelling Units ¹	
Weekday Total ²			
	Entering	326 veh	
	Exiting	<u>326 veh</u>	
	Total	652 trips	
Weekday AM Peak Hour ²			
	Entering	11 veh	
	Exiting	<u>30 veh</u>	
	Total	41 trips	
Weekday PM Peak Hour ²			
	Entering	32 veh	
	Exiting	<u>21 veh</u>	
	Total	53 trips	

¹ ITE LUC 221: Multi-Family Housing (Mid-Rise)

² Trip Equation Method

³ Trip Rate Method

All vehicle-trips associated with the proposed residential development will be “primary” trips, or new trips to the area. Appendix F contains the trip generation computations for the proposed residential development, along with a diagram that summarizes the distribution of the primary trips at the various study area intersections.

¹ Institute of Transportation Engineers, *Trip Generation*, tenth edition (Washington, D.C., 2017).

BUILD TRAFFIC PROJECTIONS

In order to identify the net impact that site traffic will have in the study area, future traffic projections with and without the proposed development are necessary. The future traffic projections with the proposed residential units are referred to as “Build” traffic projections.

The Build traffic volume projections for 2020 and 2030 are summarized schematically on Figure 5 and Figure 6, respectively. These projections are based on the No-Build projections, the trip generation estimates contained in Table 1 and the expectation that the primary trips will be distributed in the following manner:

To/From	Percentage
Bartlett Street - West	50%
Bartlett Street - East	50%
	100%

These percentages were based on analysis of the travel patterns observed entering and exiting the existing Shared Driveway on Bartlett Street, as well as our knowledge of the local area.

IMPACT SUMMARY

The net impact that the proposed residential development will have on area roadway and intersection traffic volumes can be estimated by comparing the No-Build traffic projections with the Build projections. A comparison for the two peak hour cases is summarized on Figure 7.

In terms of roadway segments, this analysis shows that the greatest impact in terms of magnitude will occur during the PM peak hour period on the section of Bartlett Street, west of the existing Shared Driveway intersection. The traffic volume on this roadway segment is projected to increase +2% (+26 vehicles) during the worst-case PM peak hour period. During the AM peak hour the impacts to roadway volumes will be slightly less with an increase of +20 vehicles; which corresponds to a +2% increase.

In terms of intersection utilization (total vehicles entering), the Bartlett Street/Existing Shared Driveway intersection is expected to accommodate +53 additional vehicles during the PM peak hour period. This +4% increase translates into approximately one additional vehicle every minute on average, during the highest traffic hour of the day. The Bartlett Street/Islington Street intersection is projected to accommodate +27 vehicles (+1%) during the PM peak hour period. The net increases during the AM peak hour will be lower than during the PM peak hour.

AM Peak Hour

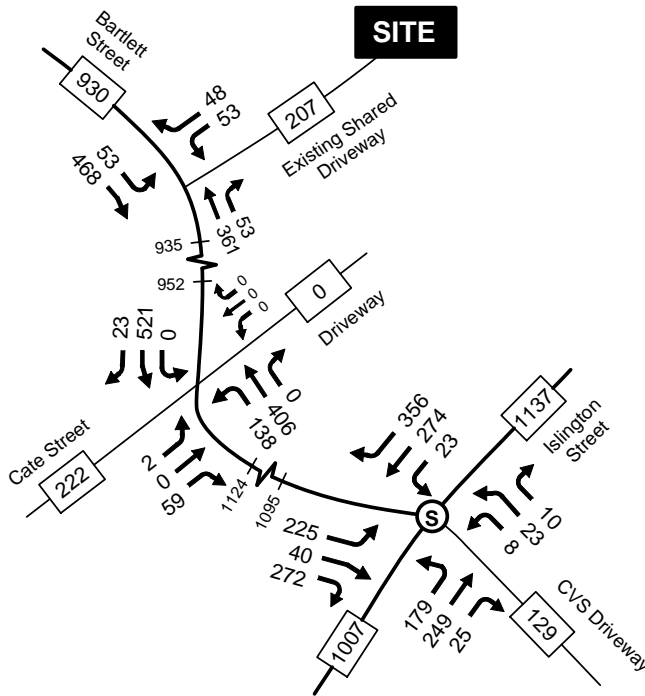

PM Peak Hour

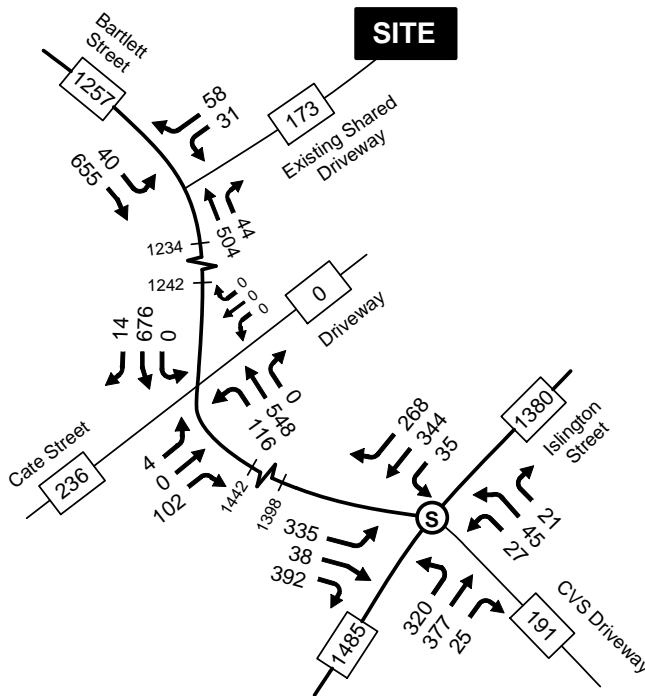
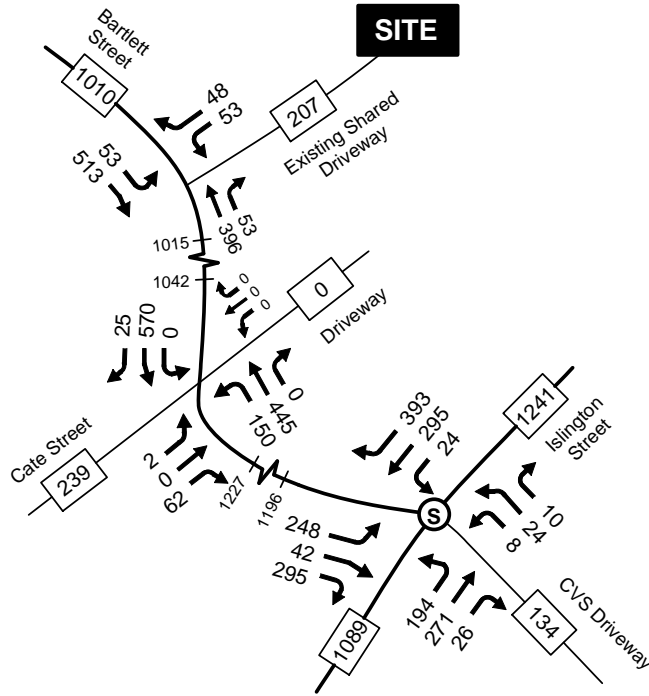

Figure 5

2020 Build Traffic Volumes

Traffic Impact and Site Access Study, Proposed Residential Subdivision, Portsmouth, New Hampshire

AM Peak Hour



PM Peak Hour

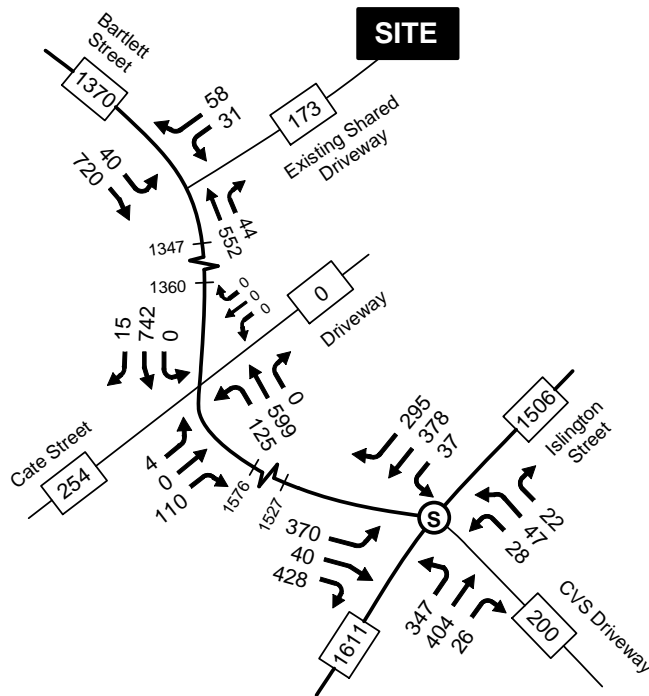
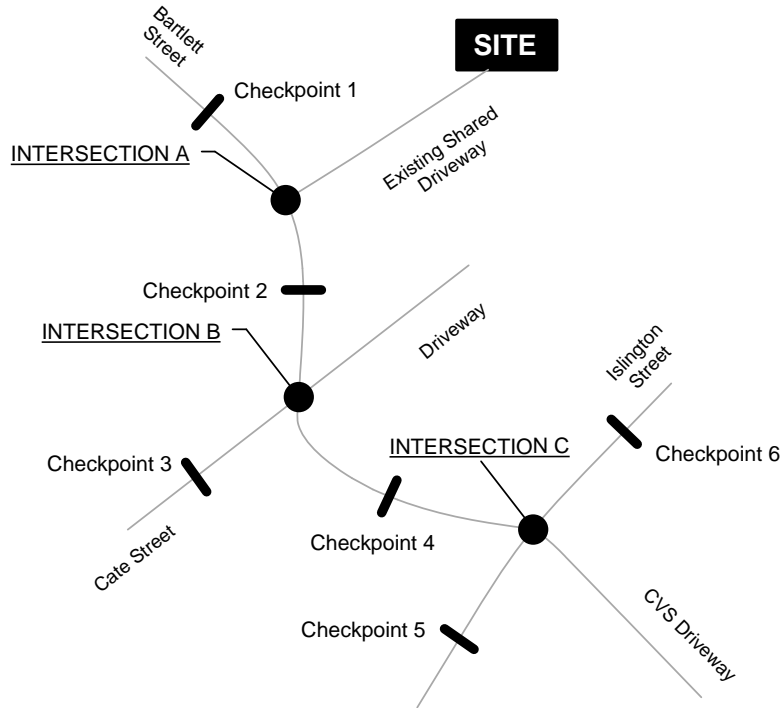

Figure 6

2030 Build Traffic Volumes

Traffic Impact and Site Access Study, Proposed Residential Subdivision, Portsmouth, New Hampshire



AM Peak Hour

Location	2020 No-Build	2020 Build	Change	% Change
Intersection A	995	1036	+41 veh	4%
Intersection B	1128	1149	+21 veh	2%
Intersection C	1664	1684	+20 veh	1%
Checkpoint 1	910	930	+20 veh	2%
Checkpoint 2	914	935	+21 veh	2%
Checkpoint 3	221	222	+1 veh	0%
Checkpoint 4	1104	1124	+20 veh	2%
Checkpoint 5	998	1007	+9 veh	1%
Checkpoint 6	1126	1137	+11 veh	1%

PM Peak Hour

Location	2020 No-Build	2020 Build	Change	% Change
Intersection A	1279	1332	+53 veh	4%
Intersection B	1433	1460	+27 veh	2%
Intersection C	2200	2227	+27 veh	1%
Checkpoint 1	1231	1257	+26 veh	2%
Checkpoint 2	1207	1234	+27 veh	2%
Checkpoint 3	236	236	0 veh	0%
Checkpoint 4	1415	1442	+27 veh	2%
Checkpoint 5	1471	1485	+14 veh	1%
Checkpoint 6	1367	1380	+13 veh	1%



Figure 7

2020 Impact Summary

Traffic Impact and Site Access Study, Proposed Residential Subdivision, Portsmouth, New Hampshire

TRAFFIC OPERATIONS AND SAFETY

INTERSECTION CAPACITY – UNSIGNALIZED INTERSECTIONS

The short-range and long-range traffic projections were utilized to assess traffic operations at the **Bartlett Street/Existing Shared Driveway** and the **Bartlett Street/Cate Street** intersections. These intersections were analyzed according to the methodologies of the *Highway Capacity Manual*² as replicated by the latest edition of the *Synchro Traffic Signal Timing Software (Version 8)*, which also performs unsignalized intersection capacity analyses.

Capacity and Level of Service (LOS) calculations pertaining to unsignalized intersections address the quality of service for those vehicles turning into and out of intersecting side streets. The availability of adequate gaps in the traffic stream on the major street (Bartlett Street) actually controls the potential capacity for vehicle movements to and from the minor approaches (Existing Shared Driveway and Cate Street). Levels of Service are simply letter grades (A-F), which categorize the vehicle delays associated with specific turning maneuvers. Table 2 describes the criteria used in this analysis. Calculations pertaining to these analyses are included in Appendix G.

Table 2	Level-of-Service Criteria for Unsignalized Intersections
Level of Service	Control Delay (seconds/vehicle)
A	≤ 10.0
B	> 10.0 and ≤ 15.0
C	> 15.0 and ≤ 25.0
D	> 25.0 and ≤ 35.0
E	> 35.0 and ≤ 50.0
F	> 50.0

Source: Transportation Research Board, *Highway Capacity Manual* 2010.

It should be noted that this methodology is not capable of accounting for the vehicle queues that were observed on Bartlett Street that extended back from the traffic signal at Islington Street. This occurred occasionally during the PM peak hour; more so at the Cate Street intersection and to a lesser extent at the Shared Driveway. Nevertheless, driver courtesy was observed in several instances that enabled certain vehicles to turn during congested moments.

² Transportation Research Board, *Highway Capacity Manual* (Washington, D.C., 2010).

The results of the analysis for the **Bartlett Street/Existing Shared Driveway** intersection are summarized on Table 3, and demonstrate that the departure movements from the Existing Shared Driveway will operate at LOS D (2020) and LOS E (2030) or higher during all hours of the day with the residential development in full operation. The left-turn arrival movement from Bartlett Street (on to the existing Shared Driveway) will operate at LOS A during all hours of the day through the horizon year and beyond with the development fully occupied. In all cases this intersection is expected to operate below capacity through 2030 with the proposed residential development fully occupied; subject to the occasional restrictions due to vehicle queuing on Bartlett Street.

Table 3 **STOP-Controlled Intersection Capacity Analysis**
Bartlett Street / Existing Shared Driveway

	Weekday AM Peak Hour				Weekday PM Peak Hour				
	<u>Delay</u> ¹	<u>V/C</u> ²	<u>LOS</u> ³	<u>Queue</u> ⁴	<u>Delay</u> ¹	<u>V/C</u> ²	<u>LOS</u> ³	<u>Queue</u> ⁴	
Bartlett Street - EB Left-Turns									
2018 Existing	9	0.05	A	<1	8	0.02	A	<1	
2020 No Build	9	0.05	A	<1	9	0.03	A	<1	
2020 Build	9	0.06	A	<1	9	0.04	A	<1	
2030 No Build	9	0.05	A	<1	9	0.03	A	<1	
2030 Build	9	0.06	A	<1	9	0.05	A	<1	
Existing Shared Driveway - SB Left & Right Turns									
2018 Existing	20	0.30	C	1	18	0.27	C	1	
2020 No Build	24	0.35	C	2	21	0.32	C	1	
2020 Build	29	0.50	D	3	29	0.48	D	3	
2030 No Build	27	0.39	D	2	25	0.37	C	2	
2030 Build	35	0.57	E	3	37	0.56	E	3	

¹ HCM Control Delay (seconds per vehicle), ² HCM Volume to Capacity Ratio, ³ HCM Level of Service, ⁴ HCM 95th Percentile Queue (vehicles)

The results of the analysis for the **Bartlett Street/Cate Street** intersection are summarized on Table 4, and demonstrate that the departure movements from Cate Street will operate at LOS C or higher through the horizon year and beyond with the development fully occupied. The left-turn arrival movement from Bartlett Street on to Cate Street will operate at LOS B or higher during all hours of the day through the horizon year and beyond with the development fully occupied. The actual delays for certain left-turn movements from Bartlett Street to Cate Street may be longer during the PM peak hour due to the extent of vehicle queuing on Bartlett Street (and driver courtesy). In all cases this intersection will operate below capacity through 2030 and beyond with the proposed residential development fully occupied.

Table 4	STOP-Controlled Intersection Capacity Analysis Bartlett Street / Cate Street							
	Weekday AM Peak Hour				Weekday PM Peak Hour			
	Delay ¹	V/C ²	LOS ³	Queue ⁴	Delay ¹	V/C ²	LOS ³	Queue ⁴
Bartlett Street - WB Left-Turns								
2018 Existing	9	0.12	A	<1	9	0.09	A	<1
2020 No Build	9	0.16	A	1	10	0.15	A	1
2020 Build	9	0.16	A	1	10	0.15	A	1
2030 No Build	10	0.18	A	1	10	0.17	B	1
2030 Build	10	0.18	A	1	10	0.17	B	1
Cate Street - NB Left & Right Turns								
2018 Existing	13	0.07	B	<1	15	0.21	C	1
2020 No Build	14	0.14	B	1	19	0.33	C	1
2020 Build	14	0.15	B	1	19	0.34	C	2
2030 No Build	15	0.16	B	1	22	0.40	C	2
2030 Build	15	0.17	C	1	23	0.41	C	2

¹ HCM Control Delay (seconds per vehicle), ² HCM Volume to Capacity Ratio, ³ HCM Level of Service, ⁴ HCM 95th Percentile Queue (vehicles)

INTERSECTION CAPACITY – SIGNALIZED INTERSECTIONS

The **Islington Street/Bartlett Street/Pharmacy Driveway** signalized intersection was analyzed utilizing the methods of the *Highway Capacity Manual 2010*³, as replicated by *Synchro Traffic Signal Timing Software (Version 10)*. A traffic flow rate, capacity, Level of Service (LOS), and delay estimate was determined for each critical traffic movement, lane group, and for the overall intersection. Levels of Service are simply letter grades (A-F) that categorize the vehicle delays associated with specific turning maneuvers. The following table describes the criteria used in the analysis of signalized intersections.

Table 5	Level-of-Service Criteria for Signalized Intersections
Level of Service	Control Delay (seconds/vehicle)
A	≤ 10.0
B	> 10.0 and ≤ 20.0
C	> 20.0 and ≤ 35.0
D	> 35.0 and ≤ 55.0
E	> 55.0 and ≤ 80.0
F	> 80.0

Source: Transportation Research Board, *Highway Capacity Manual 2010*.

Table 6 summarizes the results of the analysis for the **Islington Street/Bartlett Street** intersection and it shows that the overall intersection will operate well below capacity and at LOS C during the AM Peak Hour through 2030 with the residential development fully occupied. During the PM peak hour this intersection will be operating close to capacity and at LOS D in 2020 regardless of the proposed residential development. By 2030 the PM peak hour traffic volumes are projected to exceed the overall capacity of the intersection and it will operate at an overall LOS E, both with and without the proposed residential development. It should be noted that these results pertain to peak-month conditions only; and the highest 15-minute interval within that peak hour. Favorably, site traffic (+20-27 vehicles) increases the overall volume-to-capacity ratio of the intersection by only one or two percentage points during the peak hour periods. It should be noted that this intersection is slated for reconstruction and upgrading of the signal system in the near future.

The calculations pertaining to these analyses are included in Appendix H.

³ Transportation Research Board, *Highway Capacity Manual* (Washington, D.C., 2010).

Table 6 Signal-Controlled Intersection Capacity Analysis Summary
Islington Street / Bartlett Street / Pharmacy Driveway

	2018 Existing				2020 No-Build				2020 Build				2030 No-Build				2030 Build							
	V/C ¹⁾	Delay ²⁾	LOS ³⁾	Queue Avg/95 th 4)	V/C ¹⁾	Delay ²⁾	LOS ³⁾	Queue Avg/95 th 4)	V/C ¹⁾	Delay ²⁾	LOS ³⁾	Queue Avg/95 th 4)	V/C ¹⁾	Delay ²⁾	LOS ³⁾	Queue Avg/95 th 4)	V/C ¹⁾	Delay ²⁾	LOS ³⁾	Queue Avg/95 th 4)				
Weekday AM Peak Hour																								
Bartlett Street - EB LT&TH	0.68	23.3	C	3 (10)	0.74	29.4	C	4 (12)	0.76	31.7	C	4 (13)	0.83	38.4	D	5 (14)	0.84	39.6	D	5 (14)	0.84	39.6	D	5 (14)
Bartlett Street - EB RT	0.15	17.0	B	0 (2)	0.19	20.0	C	0 (3)	0.19	20.6	C	0 (3)	0.22	21.6	C	0 (3)	0.24	21.7	C	0 (3)	0.24	21.7	C	0 (3)
Pharmacy Dwy - WB LT&TH&RT	0.03	14.9	B	0 (1)	0.08	17.9	B	0 (2)	0.08	18.5	B	0 (2)	0.09	19.2	B	0 (2)	0.09	19.2	B	0 (2)	0.09	19.2	B	0 (2)
Islington Street - NB LT	0.53	22.8	C	2 (5)	0.72	35.4	D	3 (9)	0.69	33.3	C	3 (9)	0.77	40.7	D	3 (10)	0.78	41.8	D	3 (10)	0.78	41.8	D	3 (10)
Islington Street - NB TH&RT	0.27	8.6	A	1 (5)	0.34	10.2	B	2 (7)	0.34	10.0	B	2 (7)	0.36	10.3	B	3 (8)	0.36	10.3	B	3 (8)	0.36	10.3	B	3 (8)
Islington Street - SB LT&TH	0.52	19.1	B	2 (7)	0.68	25.4	C	4 (11)	0.68	26.1	C	4 (12)	0.69	26.1	C	5 (13)	0.69	26.1	C	5 (13)	0.69	26.1	C	5 (13)
Islington Street - SB RT	0.23	18.5	B	0 (3)	0.25	20.6	C	0 (3)	0.25	21.1	C	0 (3)	0.27	20.9	C	0 (3)	0.28	21.0	C	0 (3)	0.28	21.0	C	0 (3)
Overall	0.61	18.0	B		0.73	22.5	C		0.73	23.0	C		0.77	24.9	C		0.78	25.3	C		0.78	25.3	C	
Cycle Length	75.0				90.0				90.0				90.0				90.0				90.0			
Weekday PM Peak Hour																								
Bartlett Street - EB LT&TH	0.81	34.6	C	5 (15)	1.10	114.3	F	10 (23)	1.09	108.3	F	10 (23)	1.23	161.0	F	12 (26)	1.26	173.4	F	13 (26)	1.26	173.4	F	13 (26)
Bartlett Street - EB RT	0.27	20.8	C	0 (4)	0.50	31.6	C	3 (9)	0.50	30.9	C	3 (9)	0.59	33.6	C	4 (11)	0.61	34.1	C	4 (12)	0.61	34.1	C	4 (12)
Pharmacy Dwy - WB LT&TH&RT	0.11	18.2	B	1 (1)	0.41	29.3	C	3 (4)	0.39	28.4	C	2 (4)	0.49	30.5	C	3 (4)	0.50	30.8	C	3 (4)	0.50	30.8	C	3 (4)
Islington Street - NB LT	0.83	45.3	D	4 (12)	1.05	106.0	F	9 (20)	1.08	112.5	F	9 (21)	1.14	136.2	F	10 (22)	1.17	145.0	F	11 (23)	1.17	145.0	F	11 (23)
Islington Street - NB TH&RT	0.30	10.9	B	2 (7)	0.43	13.5	B	5 (13)	0.44	14.1	B	6 (13)	0.46	13.8	B	6 (14)	0.46	13.8	B	6 (14)	0.46	13.8	B	6 (14)
Islington Street - SB LT&TH	0.75	31.3	C	5 (14)	0.78	37.9	D	9 (20)	0.82	42.5	D	9 (21)	0.91	52.3	D	10 (37)	0.91	52.3	D	10 (37)	0.91	52.3	D	10 (37)
Islington Street - SB RT	0.17	22.3	C	0 (3)	0.18	25.9	C	0 (3)	0.18	26.6	C	0 (3)	0.21	26.1	C	0 (3)	0.21	26.2	C	0 (3)	0.21	26.2	C	0 (3)
Overall	0.81	27.3	C		0.97	52.2	D		0.99	53.2	D		1.09	67.7	E		1.10	70.8	E		1.10	70.8	E	
Cycle Length	90.0				120.0				120.0				120.0				120.0				120.0			

1) Volume-to-capacity ratio, 2) Delay in vehicles per seconds, 3) Level of Service, 4) Queue length in vehicles

AUXILIARY TURN LANES

Determining the appropriate design of the existing shared driveway intersection should take into account the hourly traffic volumes and turning movement patterns, vehicle types and speeds, and the projected Level of Service and capacity analysis results. These intersections were also analyzed to determine the ideal approach lane configuration for providing efficient traffic operations.

Left-Turn Treatment – The type of treatment needed to accommodate left-turning vehicles from any street or highway to an intersecting side street (or driveway) can range from no treatment where turning volumes are low; to the provision of a bypass lane for through traffic to travel around left-turning vehicles; to the addition of a formal center turn lane used exclusively by left-turning vehicles for deceleration and storage while waiting to complete their maneuvers.

Analysis of the 2020 traffic volume projections using NCHRP 457 guidelines is summarized below and confirms that left-turn treatment is advisable at both intersections without the proposed residential development. This means that the residential development is not triggering the need for improvements along Bartlett Street. The calculations pertaining to this analysis are included in Appendix I.

Table 7	Left-Turn Lane Warrants Analysis - 2020			
	2020 AM Peak Hour		2020 PM Peak Hour	
	No Build	Build	No Build	Build
<u>BARTLETT ST / SHARED DRIVEWAY</u>				
Left-Turn Volume (EB)	48	53	24	40
Advancing Volume (EB)	516	521	679	695
Opposing Volume (WB)	408	414	532	548
Percent Lefts	9.3%	10.2%	3.5%	5.8%
Speed (mph)	20	20	20	20
Limiting Advancing Volume (veh/hr)	461	440	638	496
Conclusion				
Left-Turn Treatment Warranted	YES	YES	YES	YES
<u>BARTLETT ST / CATE ST</u>				
Left-Turn Volume (WB)	138	138	116	116
Advancing Volume (WB)	538	544	648	664
Opposing Volume (EB)	529	544	679	690
Percent Lefts	25.7%	25.4%	17.9%	17.5%
Speed (mph)	20	20	20	20
Limiting Advancing Volume (veh/hr)	271	267	265	264
Conclusion				
Left-Turn Treatment Warranted	YES	YES	YES	YES

Right-Turn Treatment – The type of treatment needed to accommodate right-turning vehicles from any street or highway to any intersecting side street (or driveway) can range from a corner radius only, where turning volumes are low; to the provision of a short 10:1 right-turn taper; to the addition of an exclusive right-turn lane, where turning volumes and through traffic volumes are significant.

Analysis of the 2030 Build traffic volume projections and NCHRP 457 guidelines is summarized in Table 8 and confirms that right-turn treatment is not warranted at either the Shared Driveway or Cate Street intersections on Bartlett Street. This finding means that the existing travel lane on Bartlett Street will continue to function adequately as a shared through-right lane for vehicles entering both the subject site and Cate Street. The calculations pertaining to these analyses are also included in Appendix I.

Table 8	Right-Turn Lane Warrants Analysis - 2030	
	2030 AM Build Volumes	2030 PM Build Volumes
<u>BARTLETT ST / SHARED DRIVEWAY</u>		
Right-Turn Volume (WB)	53	44
Total Approach Volume (WB)	449	596
Speed (mph)	20	20
Limiting RT Volume (veh/hr)	>1000	>1000
Conclusion		
Add Right-Turn Bay	NO	NO
<u>BARTLETT ST / CATE ST</u>		
Right-Turn Volume (EB)	25	15
Total Approach Volume (EB)	595	757
Speed (mph)	20	20
Limiting RT Volume (veh/hr)	>1000	>1000
Conclusion		
Add Right-Turn Bay	NO	NO

Minor-Road Approach Analysis – The type of treatment needed to accommodate exiting vehicles from the minor-road approach at a stop-controlled intersection can range from a single lane (shared left-right lane) in low-volume conditions, to two exit lanes (exclusive left-turn lane and exclusive right-turn lane) where turning volumes and through traffic volumes are significant, to multiple exit lanes in extreme cases.

Analysis of the Shared Driveway and Cate Street intersections on Bartlett Street using the 2030 traffic volumes and NCHRP 457 guidelines is summarized on Table 9 below. The analysis demonstrates that providing one shared left-right lane on these minor approaches to Bartlett Street is sufficient for the anticipated traffic volumes. The calculations pertaining to this analysis are also included in Appendix I.

Table 9	Minor-Road Approach Geometry - 2030	
	2030 AM Build Volumes	2030 PM Build Volumes
<u>BARTLETT ST / SHARED DRIVEWAY</u>		
Major-Road Volume (EB-WB)	1015	1756
% Right-Turns on Minor (SB)	48%	65%
Minor-Road Approach Volume	101	89
Limiting Minor-Road Volume (veh/hr)	196	101
Conclusion		
Consider TWO Approach Lanes	NO	NO
<u>BARTLETT ST / CATE ST</u>		
Major-Road Volume (EB-WB)	1190	1481
% Right-Turns on Minor (NB)	97%	97%
Minor-Road Approach Volume	64	114
Limiting Minor-Road Volume (veh/hr)	331	265
Conclusion		
Consider TWO Approach Lanes	NO	NO

STUDY FINDINGS AND RECOMMENDATIONS

Based on the existing conditions data collected along Bartlett Street and at the three study area intersections, the anticipated traffic increases from the proposed residential development and the analysis of future traffic levels in the study area, Pernaw & Company, Inc. concludes that:

1. Traffic levels at the **Bartlett Street/Existing Shared Driveway** intersection reached peak periods from 7:30 to 8:30 AM in the morning and from 4:45 to 5:45 PM in the evening in April 2018. This intersection accommodated 892 vehicles (AM) and 1,129 vehicles (PM) during the peak hour periods. The existing Shared Driveway accommodated 166 (AM) and 120 (PM) vehicles during those respective peak periods. The heavier directional flow was inbound during the AM peak hour (57%) and outbound during the PM peak hour (57%).
2. The results of the trip generation analysis indicate that the proposed 120-unit residential development will generate approximately 41 vehicle-trips during the weekday AM peak hour; and 53 vehicles trips during the weekday PM peak hour. Most trips will be outbound during the AM peak and inbound during the PM peak hour; which is opposite from those currently using the shared driveway.
3. The greatest impact that site traffic will have on roadway volumes in the study area will occur along Bartlett Street, east of the subject site. This section of roadway is expected to see increases of approximately +21 (AM) and +27 (PM) vehicles during the peak periods. This translates into increases of +2% (AM) during both peak hour periods. Changes of this magnitude are comparable to the changes that typically occur due to random traffic flow from one day to the next.
4. The intersection capacity and Level of Service analysis pertaining to the **Bartlett Street/Existing Shared Driveway** intersection demonstrate that the departure movements from the Existing Shared Driveway will operate at LOS D (2020) and LOS E (2030) or higher during all hours of the day with the subject site fully occupied. The left-turn arrival movement from Bartlett Street on to the existing Shared Driveway will operate at LOS A during all hours of the day through the horizon year and beyond with the development fully occupied. The analysis demonstrates that this intersection will operate below capacity through 2030 with the proposed residential development. However, this finding must be tempered in that left-turn departures from the shared driveway are subject to temporary blockages due to queuing at the Islington Street traffic signal that are not reflected in this analysis.
5. The intersection capacity and Level of Service analysis pertaining to the **Bartlett Street/Cate Street** intersection demonstrate that the departure movements from Cate Street will operate at LOS C or higher through the horizon year and beyond with the development fully occupied. The left-turn arrival movement from Bartlett Street on to Cate Street will operate at LOS B or higher during all hours of the day through the horizon year and beyond with the development fully occupied. Again, left-turn arrivals and departures at Cate Street are subject to temporary blockages due to queuing on Bartlett Street due to the traffic signal Islington Street.

6. The capacity analyses of the **Islington Street/Bartlett Street/Pharmacy Driveway** intersection confirms that the overall intersection will operate well below capacity and at LOS C during the AM Peak Hour through 2030 with the residential development fully occupied. During the PM peak hour this intersection will be operating close to capacity and at LOS D in 2020 regardless of the proposed residential development. By 2030 the PM peak hour traffic volumes are projected to exceed the overall capacity of the intersection and it will operate at an overall LOS E, both with and without the proposed residential development. Favorably, site traffic (PM = +27 vehicles) increases the overall volume-to-capacity ratio of the intersection by only one or two percentage points during the peak hour periods. It should be noted that this intersection is slated for reconstruction and upgrading of the signal system in the near future.
7. The 2020 No-Build traffic volumes satisfy the NCHRP 457 guidelines for left-turn treatment on Bartlett Street at both the Shared Driveway and Cate Street intersections. This means it is advisable to re-stripe Bartlett Street to provide left-turn “pockets” for vehicles turning left from Bartlett Street at these locations (see Exhibit 1) regardless of the proposed development. In terms of cost sharing, it should be noted that site traffic represents approximately 2% of the peak hour traffic volume on this section of Bartlett Street.
8. The 2030 Build traffic volumes do not satisfy the NCHRP 457 guidelines for right-turn treatment on Bartlett Street at both the Shared Driveway and Cate Street intersections. The existing travel lanes on Bartlett Street will function adequately as a shared through-right lane at both intersections.
9. The 2030 Build traffic volumes do not satisfy the NCHRP 457 guidelines for providing dual exit lanes on the existing Shared Driveway and Cate Street approaches to Bartlett Street. A single shared left-right departure lane is sufficient for the anticipated traffic volumes.

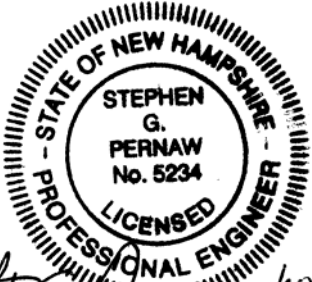

Stephen G. Pernaw 6/18/18

CONCEPT PLAN "A"

1. RE-STRIPE BARTLETT STREET TO PROVIDE A CONTINUOUS CENTER TURN LANE WITH EXCLUSIVE LEFT-TURN POCKETS FOR ARRIVALS AT THE SHARED SITE DRIVEWAY AND CATE STREET.

2. INSTALL STOP SIGN (MUTCD R1-1) ON SHARED DRIVEWAY APPROACH TO BARTLETT STREET.

3. INSTALL 24' WHITE STOP LINE, 4" WHITE EDGE LINES AND 4" DOUBLE YELLOW CENTERLINE PAVEMENT MARKINGS ON THE SHARED SITE DRIVEWAY.

4. FAIR-SHARE CALCULATION:

SITE TRAFFIC ACCOUNTS FOR APPROXIMATELY 2% OF THE 2020 POST-DEVELOPMENT TRAFFIC VOLUME ON BARTLETT STREET DURING THE AM & PM PEAK HOUR PERIODS.

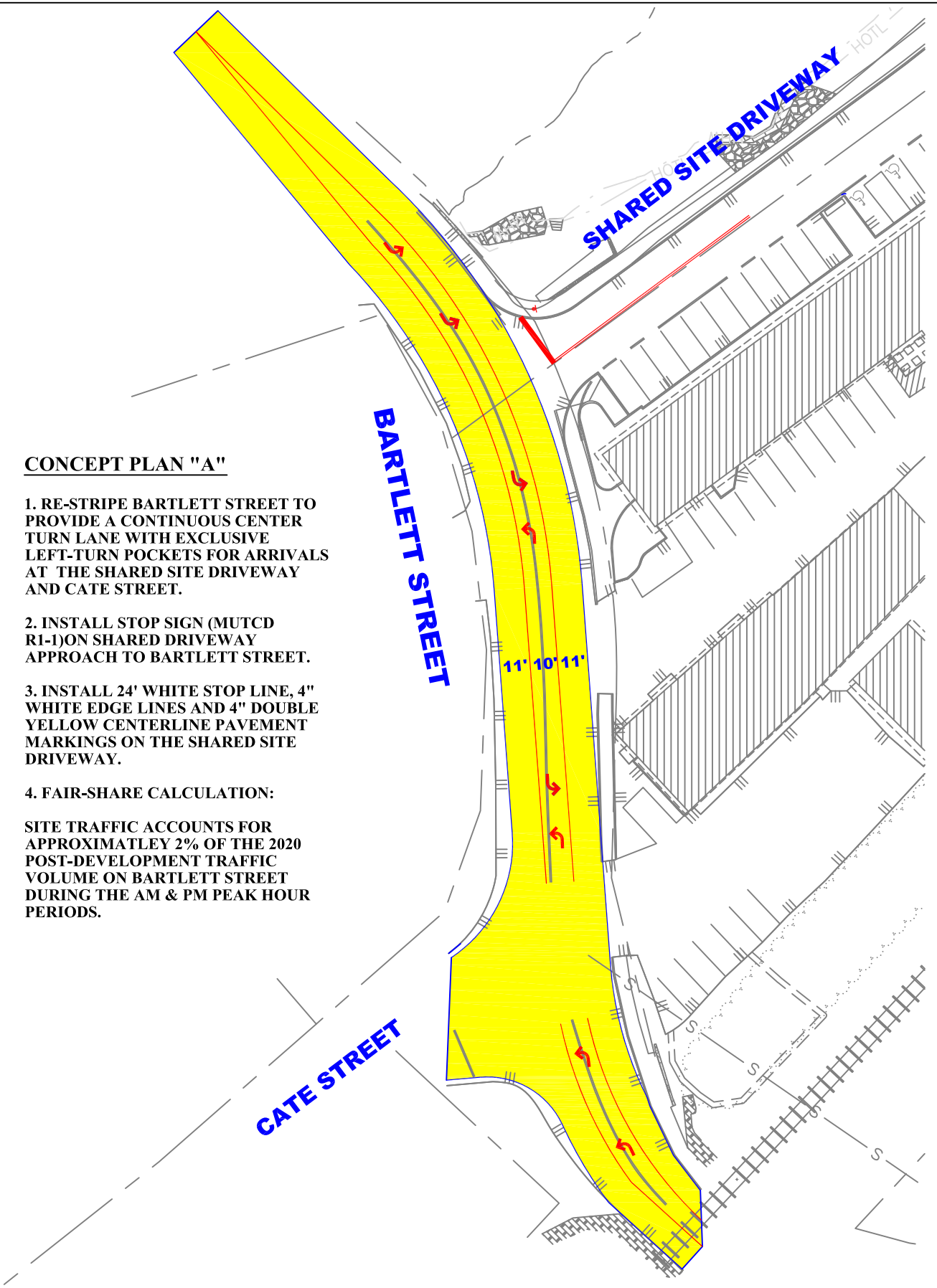

PROPOSED RESIDENTIAL DEVELOPMENT PORTSMOUTH, NEW HAMPSHIRE CLIPPER TRADERS, LLC	DRAWN: CAP	SCALE: 1" = 50'	 SGP TRANSPORTATION ENGINEERING PLANNING DESIGN
	DESIGNED: SGP	JOB NO. 1821A	
BARTLETT STREET CONCEPT PLAN "A"	CHECKED: SGP	DATE: 6/18/18	Stephen G. Pernaw & Co. Inc. PO Box 1721, Concord, NH 03302 Phone: (603) 731-8500, Fax: (603) 929-6094 E-Mail: sgp@pernaw.com

APPENDIX

Appendix A	Preliminary Site Plan
Appendix B	Automatic Traffic Recorder Counts
Appendix C	Intersection Turning Movement Counts
Appendix D	Seasonal Adjustment Factors / Historical Growth Rates
Appendix E	Other Development Traffic Volumes
Appendix F	Site Generated Traffic Volumes / Trip Distribution
Appendix G	Capacity and Level of Service Calculations – Unsignalized
Appendix H	Capacity and Level of Service Calculations - Signalized
Appendix I	Auxiliary Turn Lane Warrants

Appendix A

Preliminary Site Plan

PRELIMINARY SITE PLAN

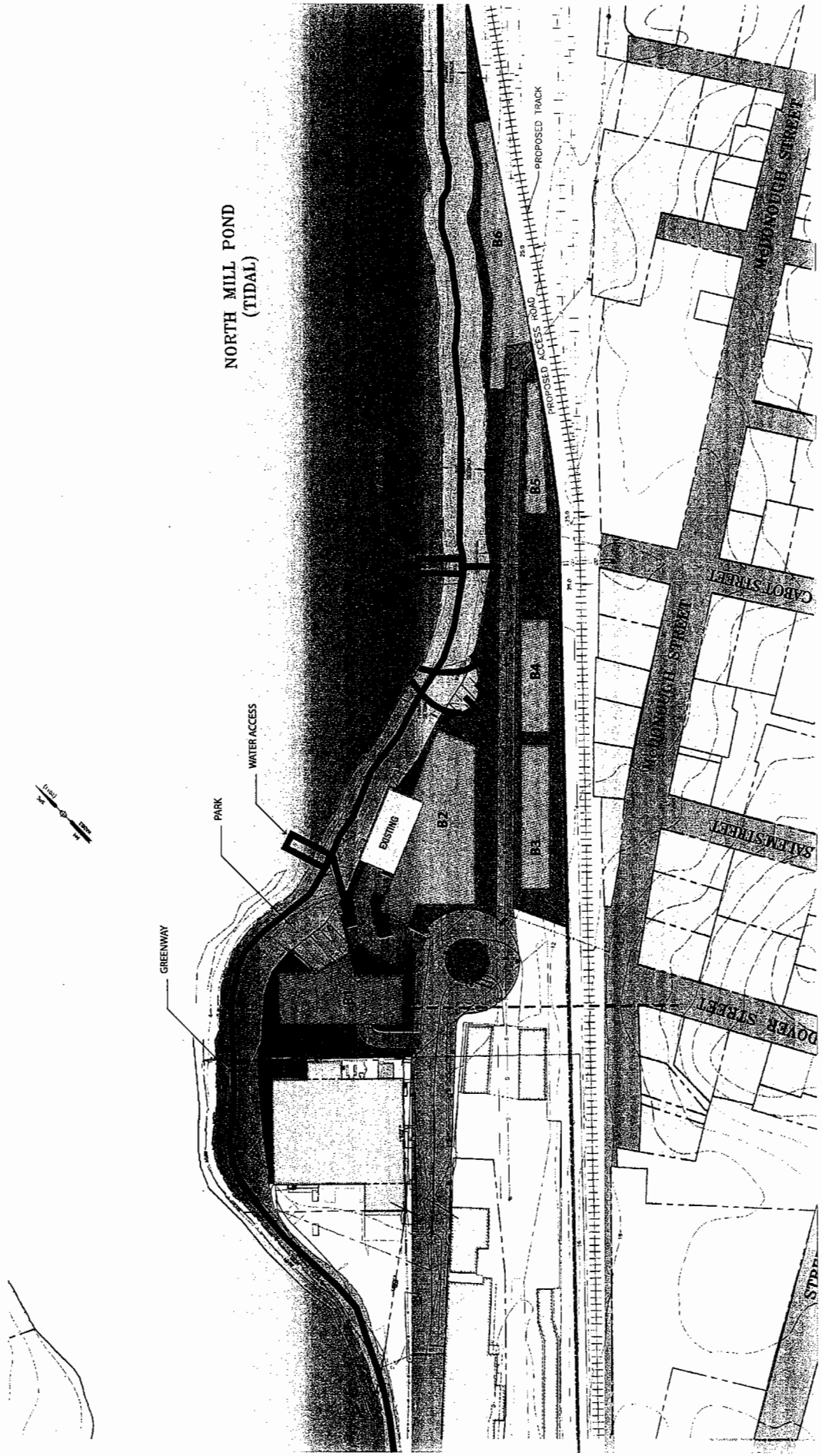

PROJECT Clipper Traders

DRAWING PRELIMINARY SITE PLAN

11/29/17

WINTER HOLBEN

Appendix B

Automatic Traffic Recorder Counts



Excel Version

Weekly Volume Report			
Location ID:	82379052	Type:	SPOT
Located On:	Bartlett St	:	
Direction:	2-WAY		
Community:	PORTSMOUTH	Period:	Mon 9/18/2017 - Sun 9/24/2017
AADT:	16414		

Start Time	Mon	Tue	Wed	Thu	Fri	Sat	Sun	Avg	Graph
12:00 AM		246	258	261				255	
1:00 AM		207	238	233				226	
2:00 AM		84	80	105				90	
3:00 AM		49	52	73				58	
4:00 AM		95	167	207				156	
5:00 AM		194	254	292				247	
6:00 AM		356	378	407				380	
7:00 AM		782	844	902				843	
8:00 AM		997	985	982				988	
9:00 AM		998	1010	1029				1,012	
10:00 AM		1134	1146	1170				1,150	
11:00 AM		1377	1387	1403				1,389	
12:00 PM		1386	1358	1349				1,364	
1:00 PM		1350	1340	1342				1,344	
2:00 PM		1326	1311	1321				1,319	
3:00 PM		1384	1376	1380				1,380	
4:00 PM		1414	1422	1434				1,423	
5:00 PM		1375	1312	1271				1,319	
6:00 PM		1071	1045	1022				1,046	
7:00 PM		800	752	720				757	
8:00 PM		593	576	568				579	
9:00 PM		480	458	445				461	
10:00 PM		392	369	345				369	
11:00 PM		203	241	247				230	
Total	0	18,293	18,359	18,508	0	0	0		
24hr Total		18293	18359	18508				18,387	
AM Pk Hr		11:00	11:00	11:00					
AM Peak		1377	1387	1403				1,389	
PM Pk Hr		4:00	4:00	4:00					
PM Peak		1414	1422	1434				1,423	
% Pk Hr		7.73%	7.75%	7.75%				7.74%	



Transportation Data Management System



Excel Version

Weekly Volume Report			
Location ID:	82379018	Type:	SPOT
Located On:	Woodbury Ave	:	
Direction:	2-WAY		
Community:	PORTSMOUTH	Period:	Mon 9/12/2016 - Sun 9/18/2016
AADT:	6154		

Start Time	Mon	Tue	Wed	Thu	Fri	Sat	Sun	Avg	Graph
12:00 AM	23	17						20	
1:00 AM	6	8						7	
2:00 AM	7	6						7	
3:00 AM	9	8						9	
4:00 AM	13	16						15	
5:00 AM	66	70						68	
6:00 AM	176	167						172	
7:00 AM	408	406						407	
8:00 AM	480	556						518	
9:00 AM	370	399						385	
10:00 AM	394	370						382	
11:00 AM	440	428						434	
12:00 PM	492	481						487	
1:00 PM	465	484						475	
2:00 PM	526	473						500	
3:00 PM	509	552						531	
4:00 PM	605	570						588	
5:00 PM	618	616						617	
6:00 PM	357	400						379	
7:00 PM	273	302						288	
8:00 PM	183	184						184	
9:00 PM	115	110						113	
10:00 PM	46	60						53	
11:00 PM	26	47						37	
Total	6,607	6,730	0	0	0	0	0		
24hr Total	6607	6730						6,669	
AM Pk Hr	8:00	8:00							
AM Peak	480	556						518	
PM Pk Hr	5:00	5:00							
PM Peak	618	616						617	
% Pk Hr	9.35%	9.15%						9.25%	



Excel Version

Weekly Volume Report			
Location ID:	82379018	Type:	SPOT
Located On:	Woodbury Ave	:	
Direction:	2-WAY		
Community:	PORTSMOUTH	Period:	Mon 9/5/2016 - Sun 9/11/2016
AADT:	6154		

Start Time	Mon	Tue	Wed	Thu	Fri	Sat	Sun	Avg	Graph
12:00 AM							35	35	
1:00 AM							29	29	
2:00 AM							14	14	
3:00 AM							10	10	
4:00 AM							9	9	
5:00 AM							26	26	
6:00 AM							52	52	
7:00 AM							75	75	
8:00 AM							187	187	
9:00 AM							246	246	
10:00 AM							300	300	
11:00 AM							363	363	
12:00 PM							409	409	
1:00 PM							399	399	
2:00 PM							415	415	
3:00 PM							395	395	
4:00 PM							416	416	
5:00 PM							339	339	
6:00 PM							247	247	
7:00 PM							198	198	
8:00 PM							124	124	
9:00 PM							65	65	
10:00 PM							39	39	
11:00 PM							34	34	
Total	0	0	0	0	0	0	4,426		
24hr Total							4426	4,426	
AM Pk Hr							11:00		
AM Peak							363	363	
PM Pk Hr							4:00		
PM Peak							416	416	
% Pk Hr							9.40%	9.40%	

Appendix C

Intersection Turning Movement Counts

Stephen G. Pernaw & Co., Inc.
P.O. Box 1721
Concord, New Hampshire 03302

Weather: Clear
Collected By: MV
Job Number: 1821A
Town/State: Portsmouth, NH

File Name : 1821A_INT_A_AM_PH
Site Code : 1821A
Start Date : 4/5/2018
Page No : 2

Start Time	Bartlett Street From North			Existing Shared Driveway From East			Bartlett Street From South			Int. Total
	Thru	Left	App. Total	Right	Left	App. Total	Right	Thru	App. Total	
Peak Hour Analysis From 07:00 AM to 08:45 AM - Peak 1 of 1										
Peak Hour for Entire Intersection Begins at 07:30 AM										
07:30 AM	95	8	103	3	6	9	9	77	86	198
07:45 AM	102	10	112	7	9	16	14	71	85	213
08:00 AM	97	16	113	9	11	20	11	69	80	213
08:15 AM	116	14	130	14	12	26	13	99	112	268
Total Volume	410	48	458	33	38	71	47	316	363	892
% App. Total	89.5	10.5		46.5	53.5		12.9	87.1		
PHF	.884	.750	.881	.589	.792	.683	.839	.798	.810	.832

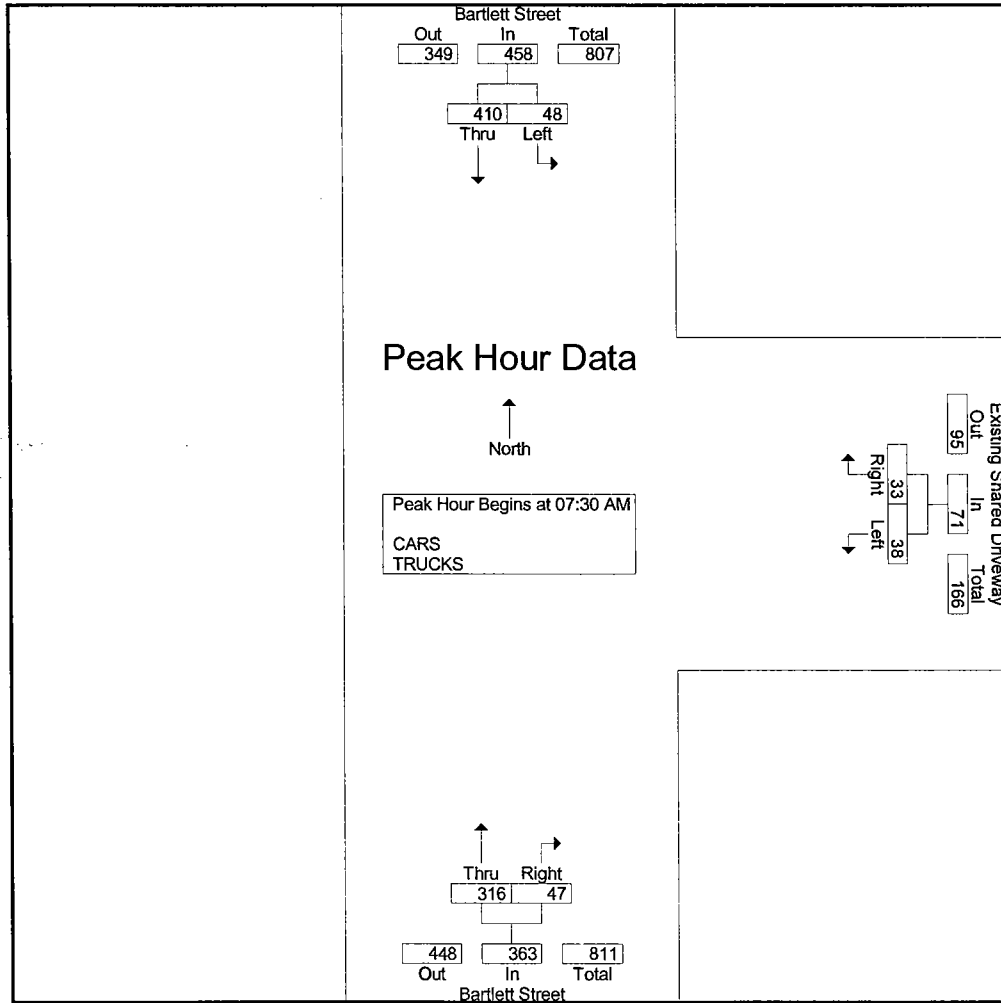

Stephen G. Pernaw & Co., Inc.
P.O. Box 1721
Concord, New Hampshire 03302

Weather: Clear
Collected By: MV
Job Number: 1821A
Town/State: Portsmouth, NH

File Name : 1821A_INT_A_AM_PH
Site Code : 1821A
Start Date : 4/5/2018
Page No : 2

Start Time	Bartlett Street From North			Existing Shared Driveway From East			Bartlett Street From South			Int. Total
	Thru	Left	App. Total	Right	Left	App. Total	Right	Thru	App. Total	
Peak Hour Analysis From 07:30 AM to 08:15 AM - Peak 1 of 1										
Peak Hour for Entire Intersection Begins at 07:30 AM										
07:30 AM	3	0	3	0	0	0	0	1	1	4
07:45 AM	1	1	2	0	1	1	0	2	2	5
08:00 AM	6	2	8	1	0	1	0	2	2	11
08:15 AM	6	0	6	3	0	3	0	3	3	12
Total Volume	16	3	19	4	1	5	0	8	8	32
% App. Total	84.2	15.8		80	20		0	100		
PHF	.667	.375	.594	.333	.250	.417	.000	.667	.667	.667

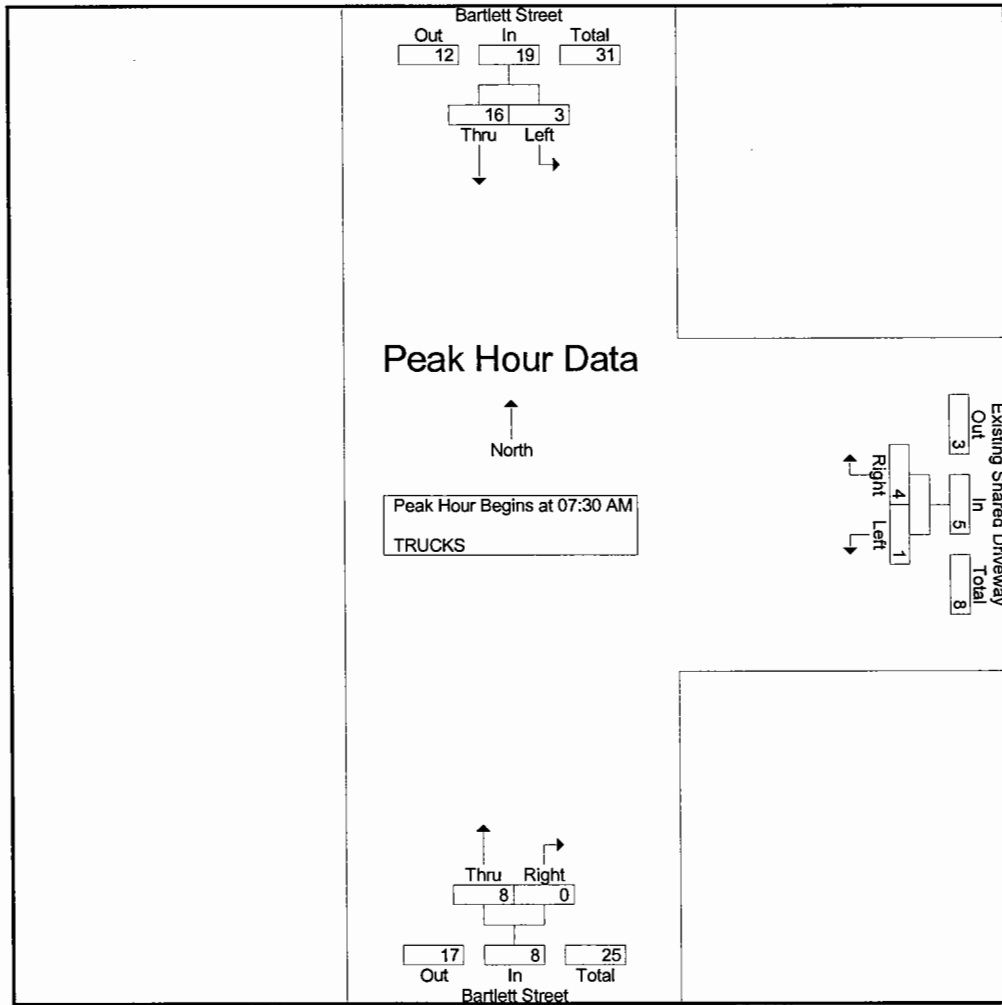

Stephen G. Pernaw & Co., Inc.
P.O. Box 1721
Concord, New Hampshire 03302

Weather: Clear
Collected By: MV
Job Number: 1821A
Town/State: Portsmouth, NH

File Name : 1821A_INT_A_AM_PH
Site Code : 1821A
Start Date : 4/5/2018
Page No : 1

Groups Printed- CARS - TRUCKS

Start Time	Bartlett Street From North				Existing Shared Driveway From East				Bartlett Street From South				Exclu. Total	Inclu. Total	Int. Total
	Thru	Left	Peds	App. Total	Right	Left	Peds	App. Total	Right	Thru	Peds	App. Total			
07:00 AM	48	8	0	56	2	10	0	12	6	47	0	53	0	121	121
07:15 AM	82	12	0	94	11	7	0	18	8	77	0	85	0	197	197
07:30 AM	95	8	0	103	3	6	0	9	9	77	0	86	0	198	198
07:45 AM	102	10	0	112	7	9	0	16	14	71	0	85	0	213	213
Total	327	38	0	365	23	32	0	55	37	272	0	309	0	729	729
08:00 AM	97	16	0	113	9	11	0	20	11	69	0	80	0	213	213
08:15 AM	116	14	0	130	14	12	0	26	13	99	0	112	0	268	268
08:30 AM	83	9	0	92	7	9	0	16	16	72	0	88	0	196	196
08:45 AM	111	6	0	117	11	14	0	25	9	63	0	72	0	214	214
Total	407	45	0	452	41	46	0	87	49	303	0	352	0	891	891
Grand Total	734	83	0	817	64	78	0	142	86	575	0	661	0	1620	1620
Apprch %	89.8	10.2			45.1	54.9			13	87					
Total %	45.3	5.1		50.4	4	4.8		8.8	5.3	35.5		40.8	0	100	
CARS	711	79		790	58	76		134	85	556		641	0	0	1565
% CARS	96.9	95.2	0	96.7	90.6	97.4	0	94.4	98.8	96.7	0	97	0	0	96.6
TRUCKS	23	4		27	6	2		8	1	19		20	0	0	55
% TRUCKS	3.1	4.8	0	3.3	9.4	2.6	0	5.6	1.2	3.3	0	3	0	0	3.4

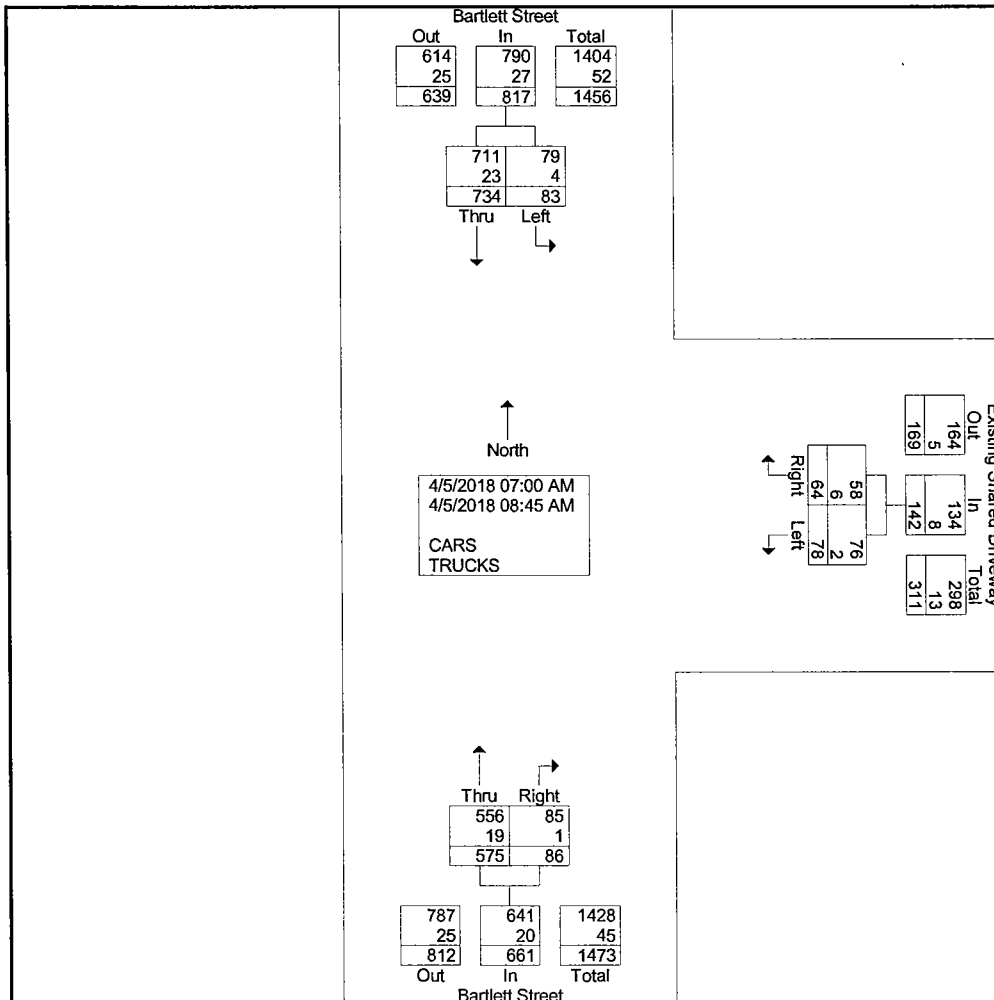

Stephen G. Pernaw & Co., Inc.
P.O. Box 1721
Concord, New Hampshire 03302

Weather: Clear
Collected By: MV
Job Number: 1821A
Town/State: Portsmouth, NH

File Name : 1821A_INT_A_AM_PH
Site Code : 1821A
Start Date : 4/5/2018
Page No : 1

Groups Printed- TRUCKS

Start Time	Bartlett Street From North				Existing Shared Driveway From East				Bartlett Street From South				Exclu. Total	Inclu. Total	Int. Total
	Thru	Left	Peds	App. Total	Right	Left	Peds	App. Total	Right	Thru	Peds	App. Total			
07:00 AM	2	1	0	3	0	1	0	1	0	2	0	2	0	6	6
07:15 AM	3	0	0	3	2	0	0	2	1	2	0	3	0	8	8
07:30 AM	3	0	0	3	0	0	0	0	0	1	0	1	0	4	4
07:45 AM	1	1	0	2	0	1	0	1	0	2	0	2	0	5	5
Total	9	2	0	11	2	2	0	4	1	7	0	8	0	23	23
08:00 AM	6	2	0	8	1	0	0	1	0	2	0	2	0	11	11
08:15 AM	6	0	0	6	3	0	0	3	0	3	0	3	0	12	12
08:30 AM	2	0	0	2	0	0	0	0	0	3	0	3	0	5	5
08:45 AM	0	0	0	0	0	0	0	0	0	4	0	4	0	4	4
Total	14	2	0	16	4	0	0	4	0	12	0	12	0	32	32
Grand Total	23	4	0	27	6	2	0	8	1	19	0	20	0	55	55
Apprch %	85.2	14.8			75	25			5	95					
Total %	41.8	7.3		49.1	10.9	3.6		14.5	1.8	34.5		36.4		100	

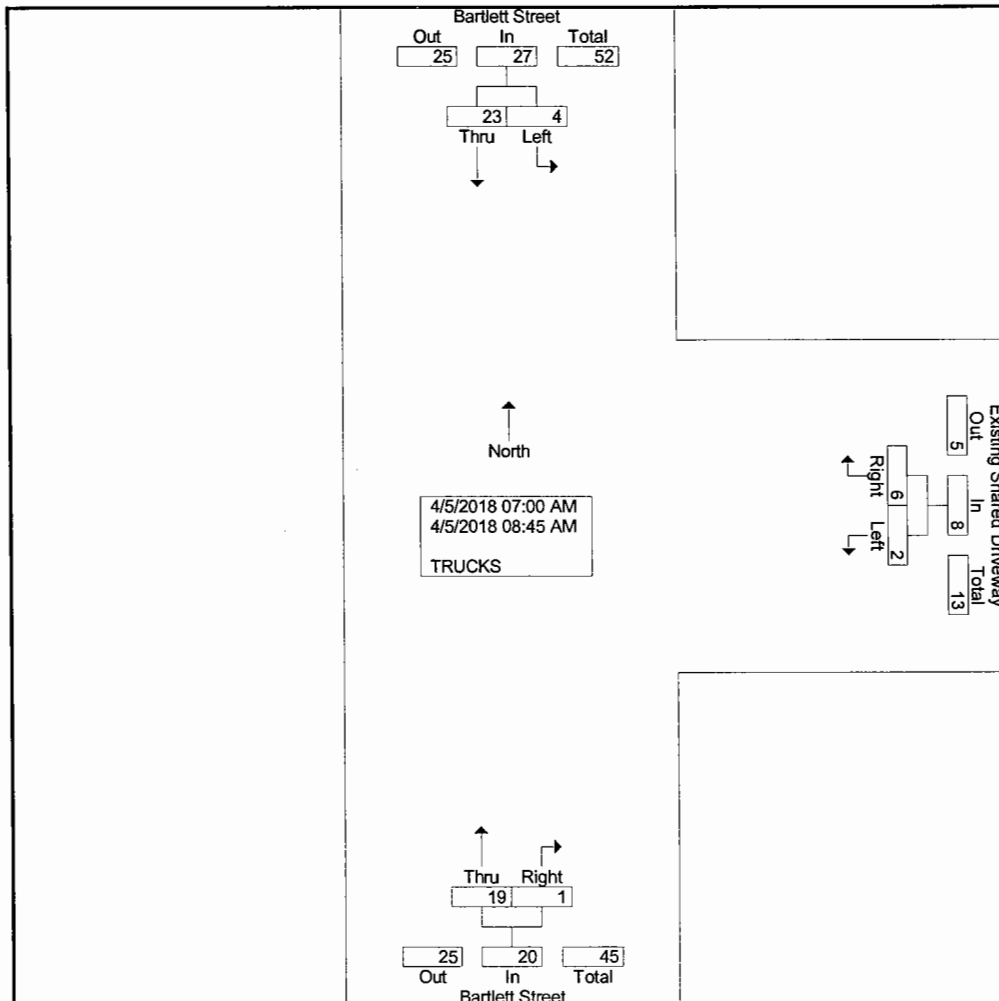

Stephen G. Pernaw & Co., Inc.
P.O. Box 1721
Concord, New Hampshire 03302

Weather: Clear
Collected By: MV
Job Number: 1821A
Town/State: Portsmouth, NH

File Name : 1821A_INT_A_PM_PH
Site Code : 1821A
Start Date : 4/5/2018
Page No : 3

Start Time	Bartlett Street From North				Existing Shared Driveway From East				Bartlett Street From South				Int. Total
	Thru	Left	Peds	App. Total	Right	Left	Peds	App. Total	Right	Thru	Peds	App. Total	
Peak Hour Analysis From 03:00 PM to 05:45 PM - Peak 1 of 1													
Peak Hour for Entire Intersection Begins at 04:45 PM													
04:45 PM	133	5	0	138	7	4	0	11	8	104	0	112	261
05:00 PM	147	6	0	153	20	6	0	26	6	117	0	123	302
05:15 PM	159	5	0	164	14	4	0	18	7	111	0	118	300
05:30 PM	141	8	0	149	7	6	0	13	7	97	0	104	266
Total Volume	580	24	0	604	48	20	0	68	28	429	0	457	1129
% App. Total	96	4	0		70.6	29.4	0		6.1	93.9	0		
PHF	.912	.750	.000	.921	.600	.833	.000	.654	.875	.917	.000	.929	.935

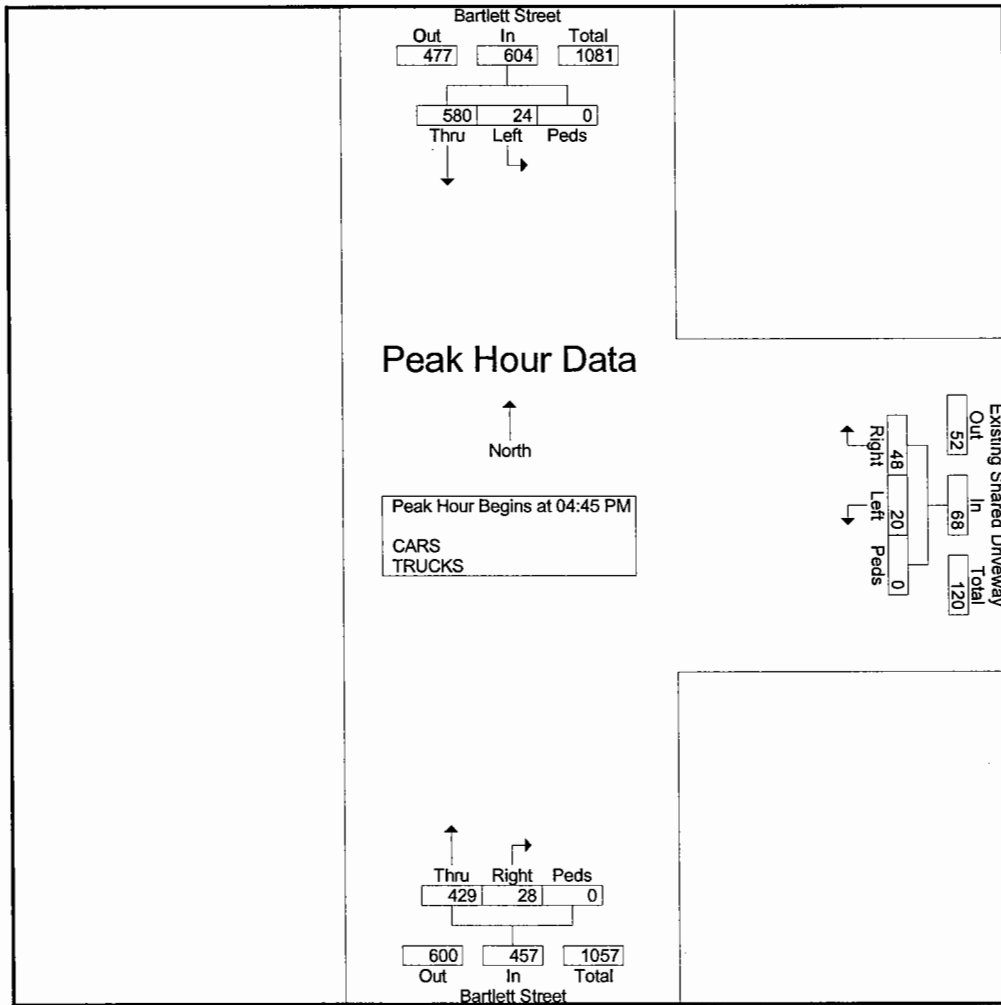

Stephen G. Pernaw & Co., Inc.
P.O. Box 1721
Concord, New Hampshire 03302

Weather: Clear
Collected By: MV
Job Number: 1821A
Town/State: Portsmouth, NH

File Name : 1821A_INT_A_PM_PH
Site Code : 1821A
Start Date : 4/5/2018
Page No : 3

Start Time	Bartlett Street From North				Existing Shared Driveway From East				Bartlett Street From South				Int. Total
	Thru	Left	Peds	App. Total	Right	Left	Peds	App. Total	Right	Thru	Peds	App. Total	
Peak Hour Analysis From 04:45 PM to 05:30 PM - Peak 1 of 1													
Peak Hour for Entire Intersection Begins at 04:45 PM													
04:45 PM	1	0	0	1	0	0	0	0	0	0	0	0	1
05:00 PM	2	0	0	2	0	0	0	0	0	0	0	0	2
05:15 PM	0	0	0	0	0	0	0	0	0	2	0	2	2
05:30 PM	1	0	0	1	0	0	0	0	0	1	0	1	2
Total Volume	4	0	0	4	0	0	0	0	0	3	0	3	7
% App. Total	100	0	0		0	0	0		0	100	0		
PHF	.500	.000	.000	.500	.000	.000	.000	.000	.000	.375	.000	.375	.875

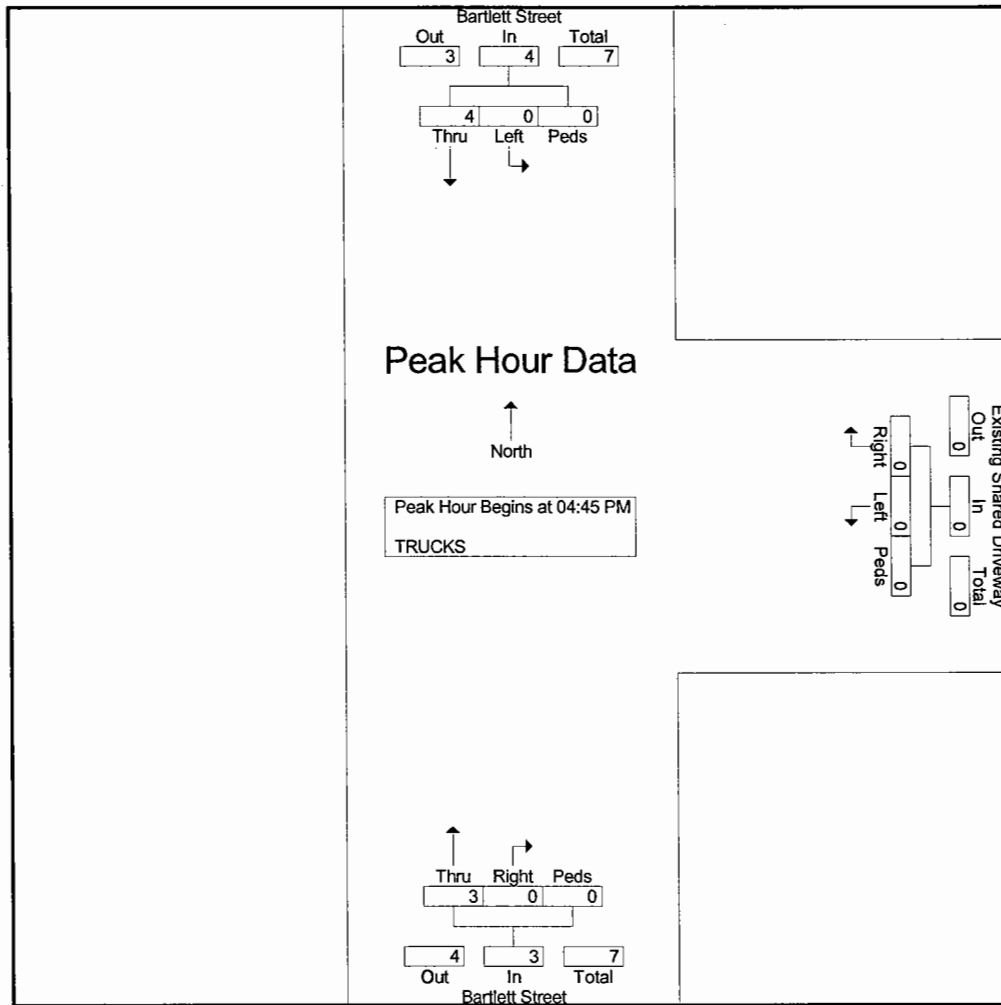

Stephen G. Pernaw & Co., Inc.
P.O. Box 1721
Concord, New Hampshire 03302

Weather: Clear
Collected By: MV
Job Number: 1821A
Town/State: Portsmouth, NH

File Name : 1821A_INT_A_PM_PH
Site Code : 1821A
Start Date : 4/5/2018
Page No : 1

Groups Printed- CARS - TRUCKS

Start Time	Bartlett Street From North				Existing Shared Driveway From East				Bartlett Street From South				Int. Total
	Thru	Left	Peds	App. Total	Right	Left	Peds	App. Total	Right	Thru	Peds	App. Total	
03:00 PM	100	3	0	103	3	5	0	8	5	94	0	99	210
03:15 PM	102	6	0	108	6	7	0	13	9	87	0	96	217
03:30 PM	97	7	0	104	5	9	0	14	2	92	0	94	212
03:45 PM	127	4	0	131	3	1	0	4	9	90	0	99	234
Total	426	20	0	446	17	22	0	39	25	363	0	388	873
04:00 PM	103	6	0	109	14	2	0	16	2	92	0	94	219
04:15 PM	136	6	0	142	6	9	0	15	7	93	0	100	257
04:30 PM	126	4	0	130	10	5	0	15	5	86	0	91	236
04:45 PM	133	5	0	138	7	4	0	11	8	104	0	112	261
Total	498	21	0	519	37	20	0	57	22	375	0	397	973
05:00 PM	147	6	0	153	20	6	0	26	6	117	0	123	302
05:15 PM	159	5	0	164	14	4	0	18	7	111	0	118	300
05:30 PM	141	8	0	149	7	6	0	13	7	97	0	104	266
05:45 PM	110	7	0	117	9	5	0	14	7	87	0	94	225
Total	557	26	0	583	50	21	0	71	27	412	0	439	1093
Grand Total	1481	67	0	1548	104	63	0	167	74	1150	0	1224	2939
Apprch %	95.7	4.3	0		62.3	37.7	0		6	94	0		
Total %	50.4	2.3	0	52.7	3.5	2.1	0	5.7	2.5	39.1	0	41.6	
CARS	1466	66	0	1532	103	63	0	166	73	1135	0	1208	2906
% CARS	99	98.5	0	99	99	100	0	99.4	98.6	98.7	0	98.7	98.9
TRUCKS	15	1	0	16	1	0	0	1	1	15	0	16	33
% TRUCKS	1	1.5	0	1	1	0	0	0.6	1.4	1.3	0	1.3	1.1

Stephen G. Pernaw & Co., Inc.
P.O. Box 1721
Concord, New Hampshire 03302

Weather: Clear
Collected By: MV
Job Number: 1821A
Town/State: Portsmouth, NH

File Name : 1821A_INT_A_PM_PH
Site Code : 1821A
Start Date : 4/5/2018
Page No : 2

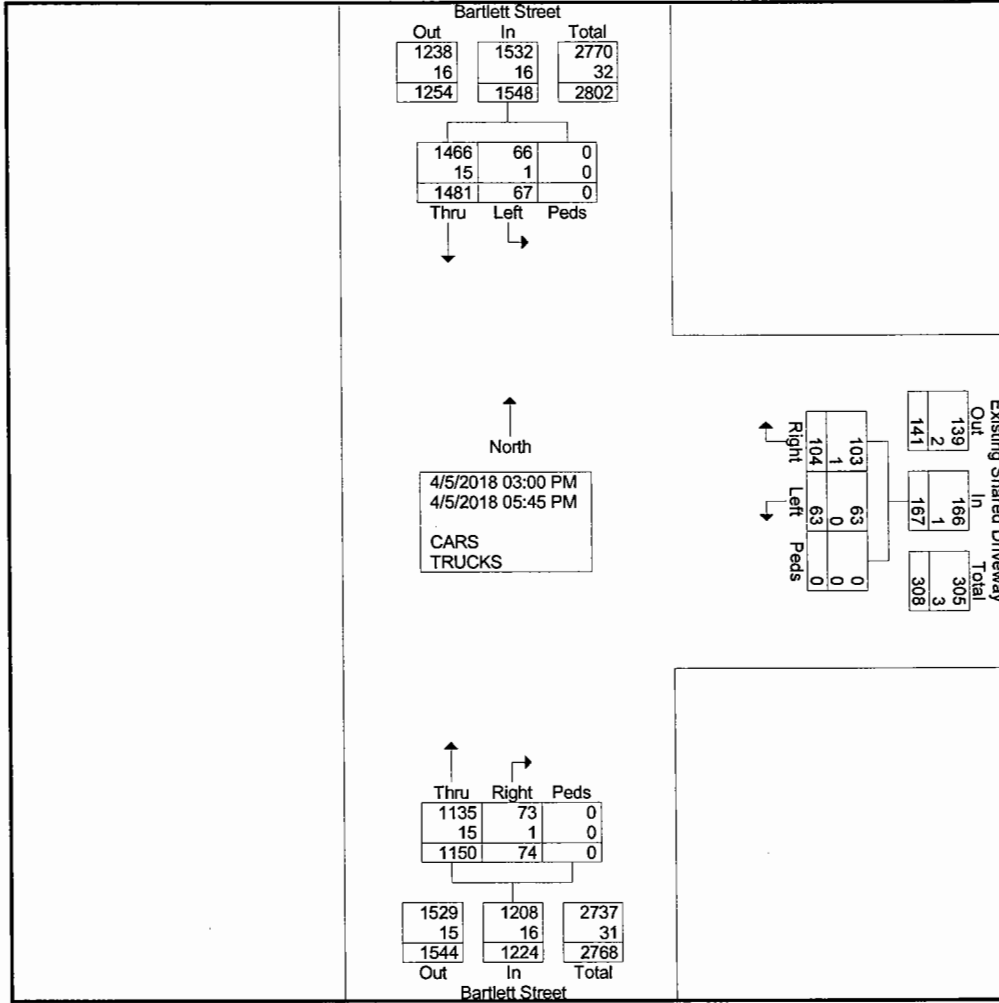

Stephen G. Pernaw & Co., Inc.
P.O. Box 1721
Concord, New Hampshire 03302

Weather: Clear
Collected By: MV
Job Number: 1821A
Town/State: Portsmouth, NH

File Name : 1821A_INT_A_PM_PH
Site Code : 1821A
Start Date : 4/5/2018
Page No : 1

Groups Printed- TRUCKS

Start Time	Bartlett Street From North				Existing Shared Driveway From East				Bartlett Street From South				Int. Total
	Thru	Left	Peds	App. Total	Right	Left	Peds	App. Total	Right	Thru	Peds	App. Total	
03:00 PM	4	0	0	4	0	0	0	0	0	3	0	3	7
03:15 PM	0	0	0	0	1	0	0	1	0	1	0	1	2
03:30 PM	1	0	0	1	0	0	0	0	0	2	0	2	3
03:45 PM	0	0	0	0	0	0	0	0	1	3	0	4	4
Total	5	0	0	5	1	0	0	1	1	9	0	10	16
04:00 PM	2	0	0	2	0	0	0	0	0	1	0	1	3
04:15 PM	1	0	0	1	0	0	0	0	0	1	0	1	2
04:30 PM	2	1	0	3	0	0	0	0	0	1	0	1	4
04:45 PM	1	0	0	1	0	0	0	0	0	0	0	0	1
Total	6	1	0	7	0	0	0	0	0	3	0	3	10
05:00 PM	2	0	0	2	0	0	0	0	0	0	0	0	2
05:15 PM	0	0	0	0	0	0	0	0	0	2	0	2	2
05:30 PM	1	0	0	1	0	0	0	0	0	1	0	1	2
05:45 PM	1	0	0	1	0	0	0	0	0	0	0	0	1
Total	4	0	0	4	0	0	0	0	0	3	0	3	7
Grand Total	15	1	0	16	1	0	0	1	1	15	0	16	33
Apprch %	93.8	6.2	0		100	0	0		6.2	93.8	0		
Total %	45.5	3	0	48.5	3	0	0	3	3	45.5	0	48.5	

Stephen G. Pernaw & Co., Inc.
P.O. Box 1721
Concord, New Hampshire 03302

Weather: Clear
Collected By: MV
Job Number: 1821A
Town/State: Portsmouth, NH

File Name : 1821A_INT_A_PM_PH
Site Code : 1821A
Start Date : 4/5/2018
Page No : 2

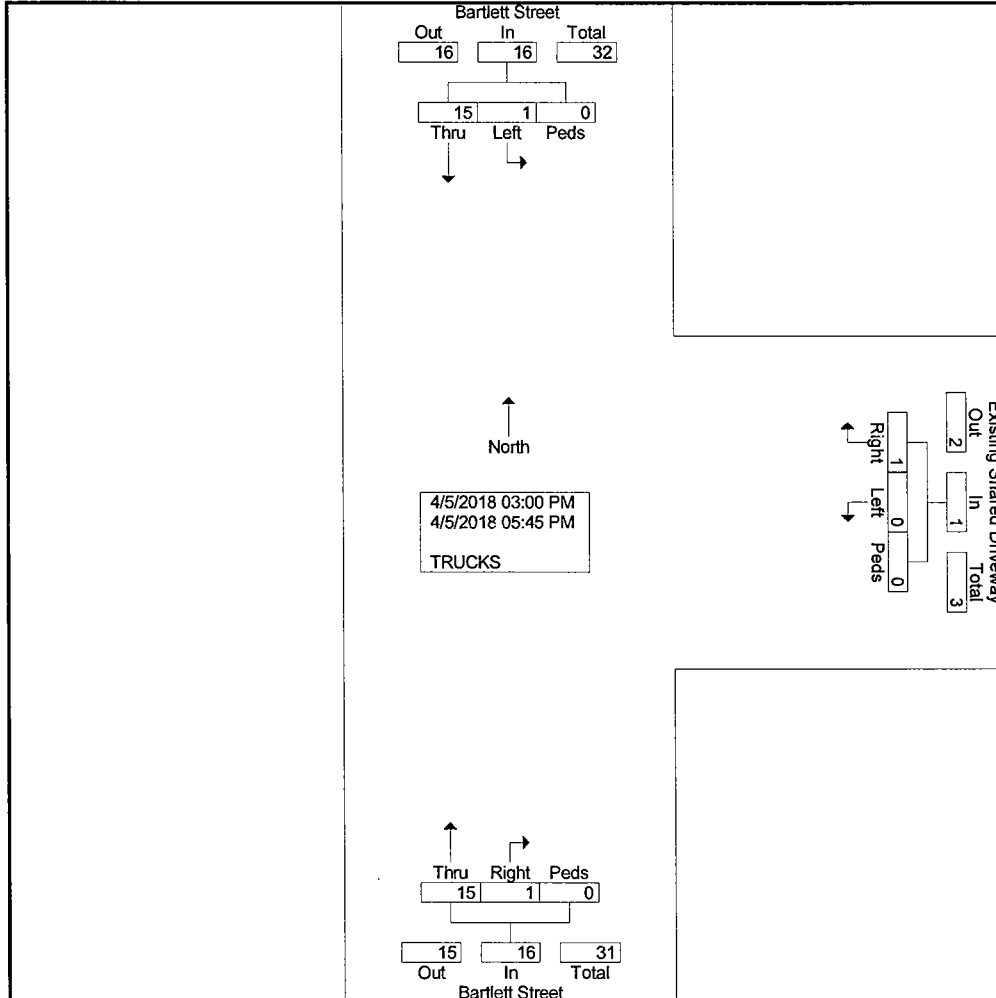

Stephen G. Pernaw & Co., Inc.
P.O. Box 1721
Concord, New Hampshire 03302

Weather: Clear
Collected By: MV
Job Number: 1821A
Town/State: Portsmouth, NH

File Name : 1821A_INT_B_AM_PH
Site Code : 1821A
Start Date : 4/5/2018
Page No : 2

Start Time	Bartlett Street From North					Existing Driveway From East					Bartlett Street From South					Cate Street From West					Int. Total
	Right	Thru	Left	Peds	App. Total	Right	Thru	Left	Peds	App. Total	Right	Thru	Left	Peds	App. Total	Right	Thru	Left	Peds	App. Total	
Peak Hour Analysis From 07:00 AM to 08:45 AM - Peak 1 of 1																					
Peak Hour for Entire Intersection Begins at 08:00 AM																					
08:00 AM	7	104	0	0	111	0	0	0	0	0	0	84	25	0	109	11	0	0	0	11	231
08:15 AM	6	121	0	0	127	0	0	0	0	0	0	110	26	0	136	5	0	1	0	6	269
08:30 AM	2	92	0	0	94	0	0	0	0	0	0	85	27	0	112	3	0	1	0	4	210
08:45 AM	6	130	0	0	136	0	0	0	0	0	0	74	32	0	106	12	0	0	0	12	254
Total Volume	21	447	0	0	468	0	0	0	0	0	0	353	110	0	463	31	0	2	0	33	964
% App. Total	4.5	95.5	0	0		0	0	0	0	0	0	76.2	23.8	0		93.9	0	6.1	0		
PHF	.750	.860	.000	.000	.860	.000	.000	.000	.000	.000	.000	.802	.859	.000	.851	.646	.000	.500	.000	.688	.896

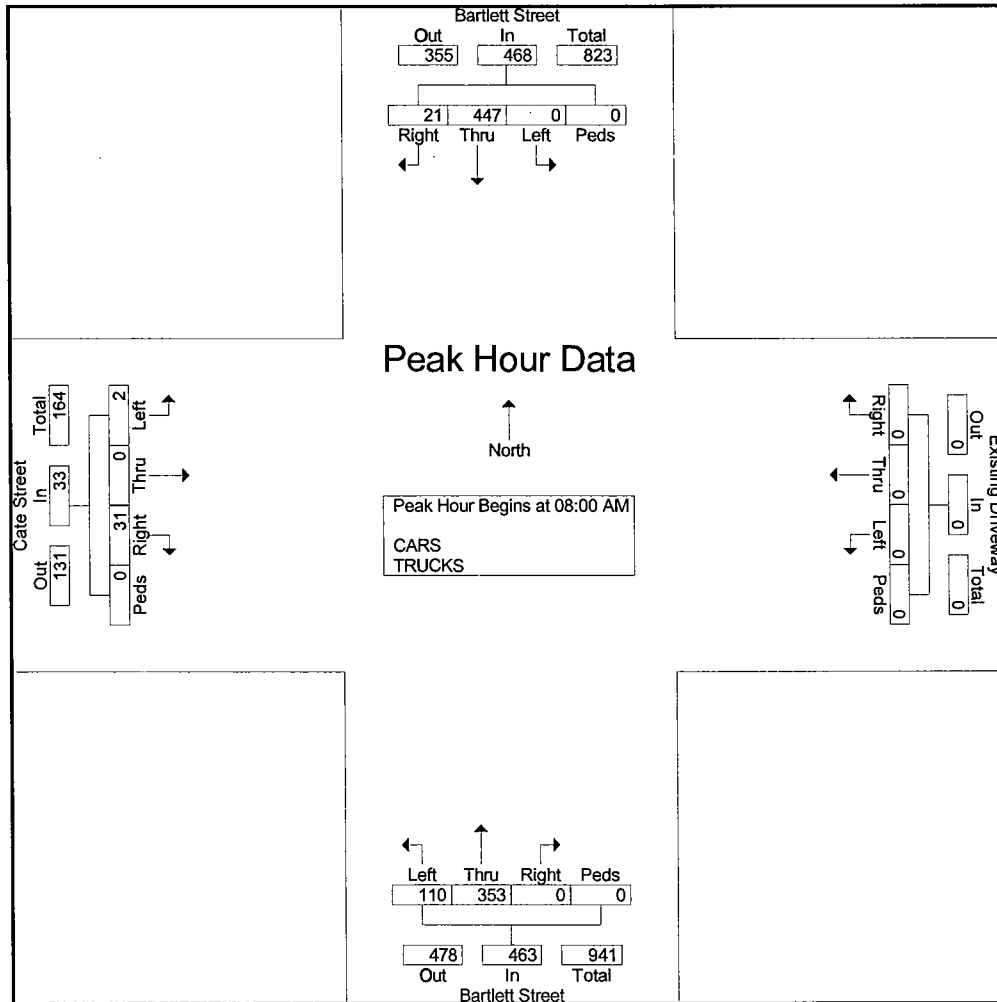

Stephen G. Pernaw & Co., Inc.
P.O. Box 1721
Concord, New Hampshire 03302

Weather: Clear
Collected By: MV
Job Number: 1821A
Town/State: Portsmouth, NH

File Name : 1821A_INT_B_AM_PH
Site Code : 1821A
Start Date : 4/5/2018
Page No : 2

Start Time	Bartlett Street From North					Existing Driveway From East					Bartlett Street From South					Cate Street From West					Int. Total
	Right	Thru	Left	Peds	App. Total	Right	Thru	Left	Peds	App. Total	Right	Thru	Left	Peds	App. Total	Right	Thru	Left	Peds	App. Total	
Peak Hour Analysis From 08:00 AM to 08:45 AM - Peak 1 of 1																					
Peak Hour for Entire Intersection Begins at 08:00 AM																					
08:00 AM	2	4	0	0	6	0	0	0	0	0	0	3	0	0	3	0	0	0	0	0	9
08:15 AM	0	4	0	0	4	0	0	0	0	0	0	2	0	0	2	1	0	1	0	2	8
08:30 AM	0	1	0	0	1	0	0	0	0	0	0	1	1	0	2	1	0	1	0	2	5
08:45 AM	0	0	0	0	0	0	0	0	0	0	0	3	2	0	5	0	0	0	0	0	5
Total Volume	2	9	0	0	11	0	0	0	0	0	0	9	3	0	12	2	0	2	0	4	27
% App. Total	18.2	81.8	0	0		0	0	0	0		0	75	25	0		50	0	50	0		
PHF	.250	.563	.000	.000	.458	.000	.000	.000	.000	.000	.000	.750	.375	.000	.600	.500	.000	.500	.000	.500	.750

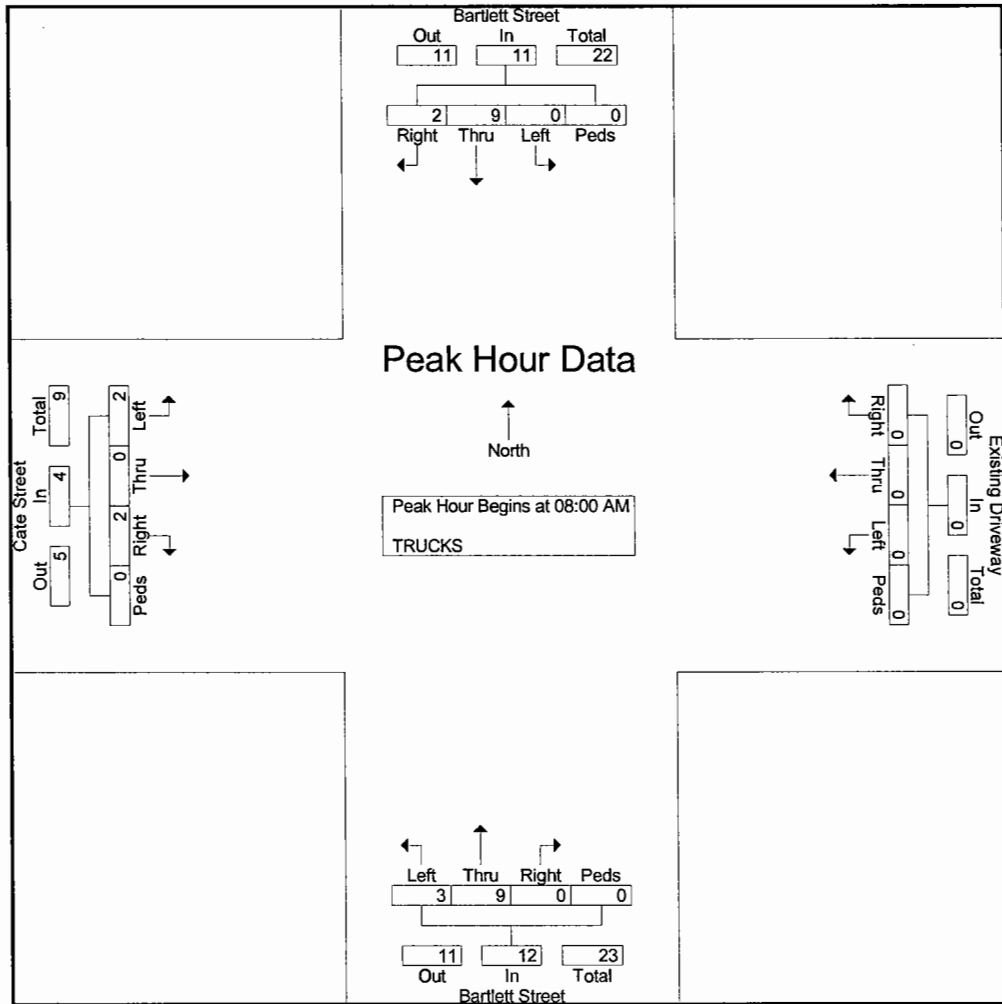

Stephen G. Pernaw & Co., Inc.
P.O. Box 1721
Concord, New Hampshire 03302

Weather: Clear
Collected By: MV
Job Number: 1821A
Town/State: Portsmouth, NH

File Name : 1821A_INT_B_AM_PH
Site Code : 1821A
Start Date : 4/5/2018
Page No : 1

Groups Printed- CARS - TRUCKS

Start Time	Bartlett Street From North					Existing Driveway From East					Bartlett Street From South					Cate Street From West					Int. Total
	Right	Thru	Left	Peds	App. Total	Right	Thru	Left	Peds	App. Total	Right	Thru	Left	Peds	App. Total	Right	Thru	Left	Peds	App. Total	
07:00 AM	1	55	0	0	56	0	0	0	0	0	0	49	28	0	77	1	0	3	0	4	137
07:15 AM	4	86	0	0	90	1	0	0	0	1	1	87	20	0	108	8	0	0	0	8	207
07:30 AM	4	94	0	0	98	0	0	0	0	0	0	85	24	0	109	3	0	1	0	4	211
07:45 AM	8	103	0	0	111	0	0	0	0	0	0	89	33	0	122	10	0	0	0	10	243
Total	17	338	0	0	355	1	0	0	0	1	1	310	105	0	416	22	0	4	0	26	798
08:00 AM	7	104	0	0	111	0	0	0	0	0	0	84	25	0	109	11	0	0	0	11	231
08:15 AM	6	121	0	0	127	0	0	0	0	0	0	110	26	0	136	5	0	1	0	6	269
08:30 AM	2	92	0	0	94	0	0	0	0	0	0	85	27	0	112	3	0	1	0	4	210
08:45 AM	6	130	0	0	136	0	0	0	0	0	0	74	32	0	106	12	0	0	0	12	254
Total	21	447	0	0	468	0	0	0	0	0	0	353	110	0	463	31	0	2	0	33	964
Grand Total	38	785	0	0	823	1	0	0	0	1	1	663	215	0	879	53	0	6	0	59	1762
Apprch %	4.6	95.4	0	0		100	0	0	0		0.1	75.4	24.5	0		89.8	0	10.2	0		
Total %	2.2	44.6	0	0	46.7	0.1	0	0	0	0.1	0.1	37.6	12.2	0	49.9	3	0	0.3	0	3.3	
CARS	35	767	0	0	802	1	0	0	0	1	1	648	211	0	860	49	0	1	0	50	1713
% CARS	92.1	97.7	0	0	97.4	100	0	0	0	100	100	97.7	98.1	0	97.8	92.5	0	16.7	0	84.7	97.2
TRUCKS	3	18	0	0	21	0	0	0	0	0	0	15	4	0	19	4	0	5	0	9	49
% TRUCKS	7.9	2.3	0	0	2.6	0	0	0	0	0	0	2.3	1.9	0	2.2	7.5	0	83.3	0	15.3	2.8

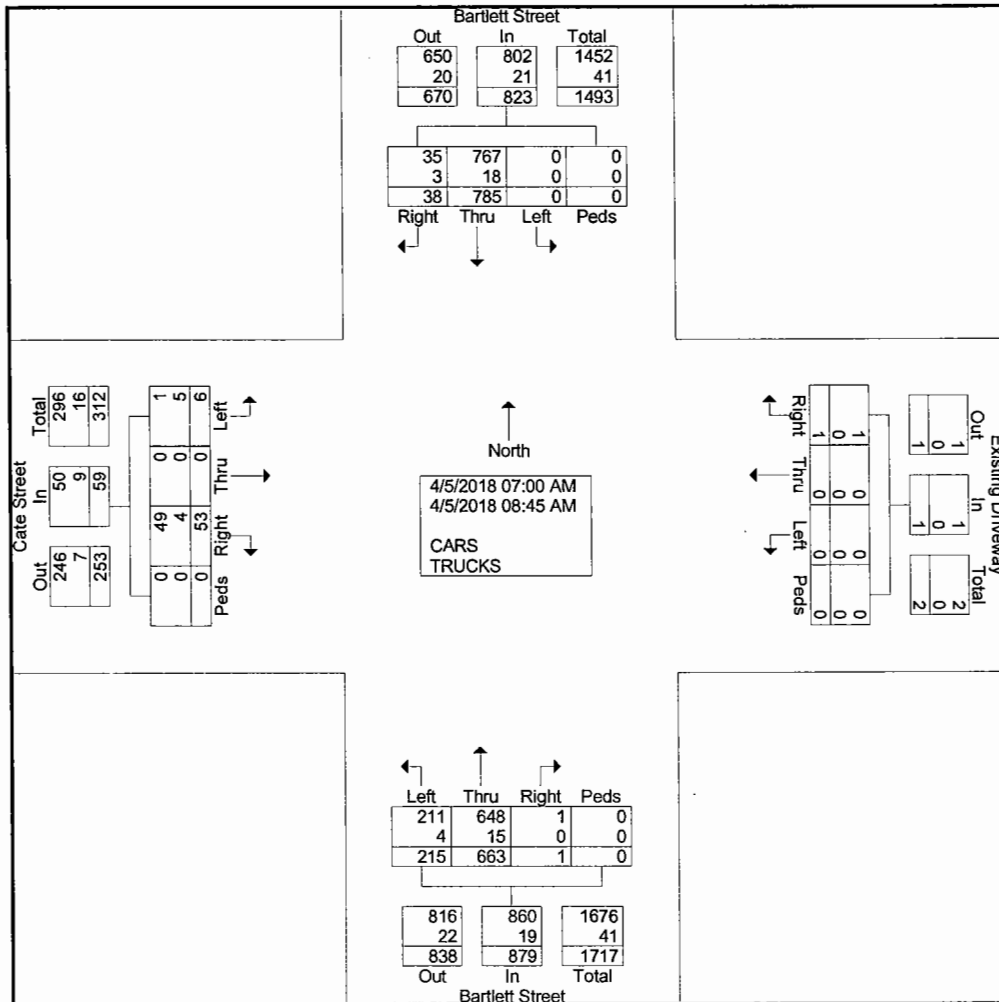

Stephen G. Pernaw & Co., Inc.
P.O. Box 1721
Concord, New Hampshire 03302

Weather: Clear
Collected By: MV
Job Number: 1821A
Town/State: Portsmouth, NH

File Name : 1821A_INT_B_AM_PH
Site Code : 1821A
Start Date : 4/5/2018
Page No : 1

Groups Printed- TRUCKS

Start Time	Bartlett Street From North					Existing Driveway From East					Bartlett Street From South					Cate Street From West					Int. Total
	Right	Thru	Left	Peds	App. Total	Right	Thru	Left	Peds	App. Total	Right	Thru	Left	Peds	App. Total	Right	Thru	Left	Peds	App. Total	
07:00 AM	0	2	0	0	2	0	0	0	0	0	0	0	0	0	0	0	0	2	0	2	4
07:15 AM	0	3	0	0	3	0	0	0	0	0	0	4	0	0	4	0	0	0	0	0	7
07:30 AM	1	2	0	0	3	0	0	0	0	0	0	0	1	0	1	0	0	1	0	1	5
07:45 AM	0	2	0	0	2	0	0	0	0	0	0	2	0	0	2	2	0	0	0	2	6
Total	1	9	0	0	10	0	0	0	0	0	0	6	1	0	7	2	0	3	0	5	22
08:00 AM	2	4	0	0	6	0	0	0	0	0	0	3	0	0	3	0	0	0	0	0	9
08:15 AM	0	4	0	0	4	0	0	0	0	0	0	2	0	0	2	1	0	1	0	2	8
08:30 AM	0	1	0	0	1	0	0	0	0	0	0	1	1	0	2	1	0	1	0	2	5
08:45 AM	0	0	0	0	0	0	0	0	0	0	0	3	2	0	5	0	0	0	0	0	5
Total	2	9	0	0	11	0	0	0	0	0	0	9	3	0	12	2	0	2	0	4	27
Grand Total	3	18	0	0	21	0	0	0	0	0	0	15	4	0	19	4	0	5	0	9	49
Apprch %	14.3	85.7	0	0		0	0	0	0		0	78.9	21.1	0		44.4	0	55.6	0		
Total %	6.1	36.7	0	0	42.9	0	0	0	0	0	0	30.6	8.2	0	38.8	8.2	0	10.2	0	18.4	

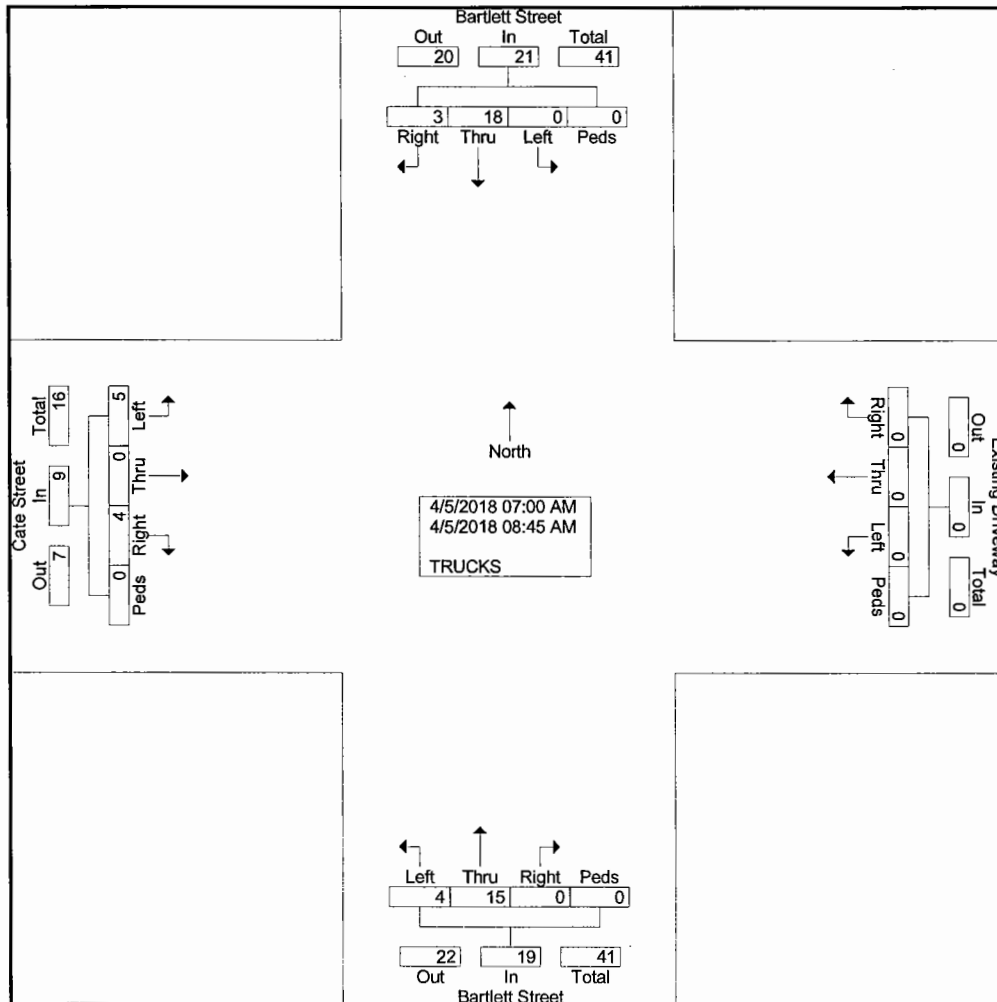

Stephen G. Pernaw & Co., Inc.
P.O. Box 1721
Concord, New Hampshire 03302

Weather: Clear
Collected By: MV
Job Number: 1821A
Town/State: Portsmouth, NH

File Name : 1821A_INT_B_PM_PH
Site Code : 1821A
Start Date : 4/5/2018
Page No : 3

Start Time	Bartlett Street From North					Existing Driveway From East					Bartlett Street From South					Cate Street From West					Int. Total
	Right	Thru	Left	Peds	App. Total	Right	Thru	Left	Peds	App. Total	Right	Thru	Left	Peds	App. Total	Right	Thru	Left	Peds	App. Total	
Peak Hour Analysis From 03:00 PM to 05:45 PM - Peak 1 of 1																					
Peak Hour for Entire Intersection Begins at 04:45 PM																					
04:45 PM	0	136	0	0	136	0	0	0	0	0	0	115	14	0	129	12	0	0	0	12	277
05:00 PM	2	151	0	0	153	0	0	0	0	0	0	126	26	0	152	23	0	0	0	23	328
05:15 PM	5	153	0	0	158	0	0	0	0	0	0	115	18	0	133	19	0	2	0	21	312
05:30 PM	5	150	0	0	155	0	0	0	0	0	0	99	20	0	119	18	0	2	0	20	294
Total Volume	12	590	0	0	602	0	0	0	0	0	0	455	78	0	533	72	0	4	0	76	1211
% App. Total	2	98	0	0		0	0	0	0		0	85.4	14.6	0		94.7	0	5.3	0		
PHF	.600	.964	.000	.000	.953	.000	.000	.000	.000	.000	.000	.903	.750	.000	.877	.783	.000	.500	.000	.826	.923

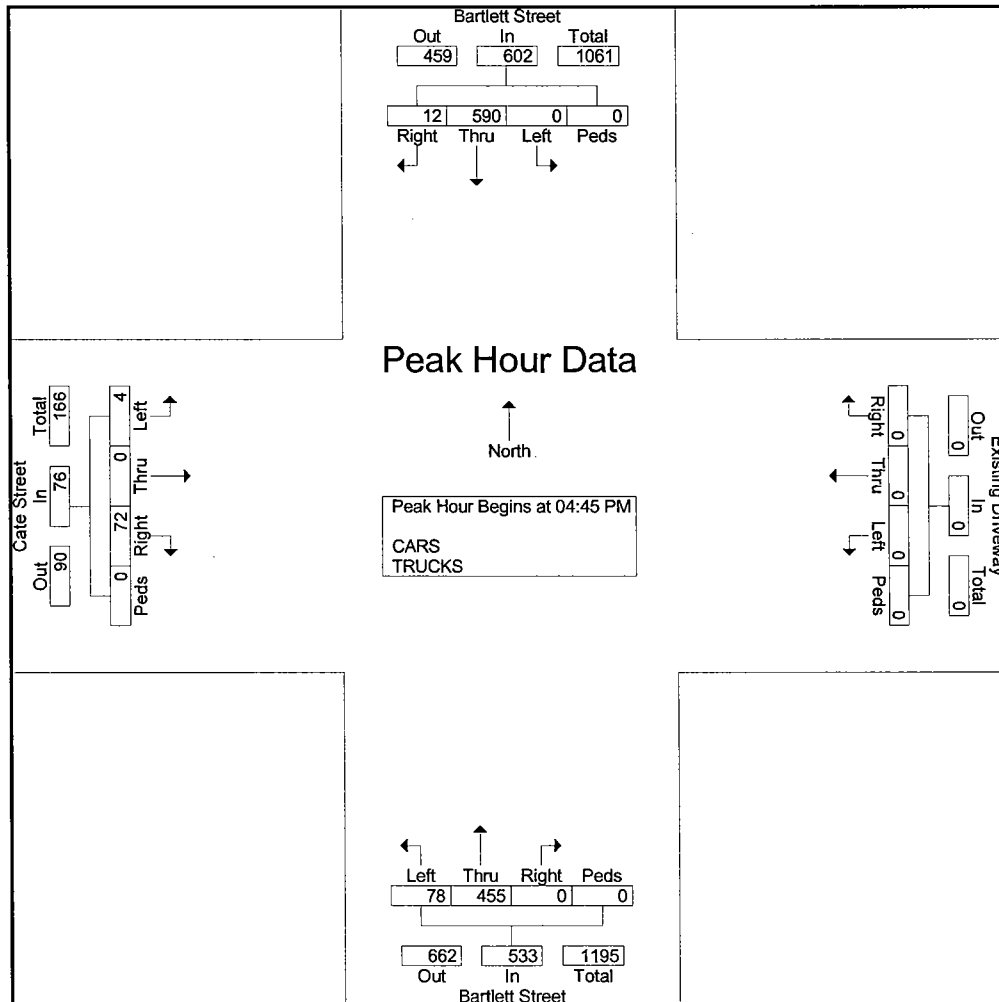

Stephen G. Pernaw & Co., Inc.
P.O. Box 1721
Concord, New Hampshire 03302

Weather: Clear
Collected By: MV
Job Number: 1821A
Town/State: Portsmouth, NH

File Name : 1821A_INT_B_PM_PH
Site Code : 1821A
Start Date : 4/5/2018
Page No : 2

Start Time	Bartlett Street From North					Existing Driveway From East					Bartlett Street From South					Cate Street From West					Int. Total	
	Right	Thru	Left	Peds	App. Total	Right	Thru	Left	Peds	App. Total	Right	Thru	Left	Peds	App. Total	Right	Thru	Left	Peds	App. Total		
Peak Hour Analysis From 04:45 PM to 05:30 PM - Peak 1 of 1																						
Peak Hour for Entire Intersection Begins at 04:45 PM																						
04:45 PM	0	1	0	0	1	0	0	0	0	0	0	0	0	0	0	0	0	0	0	0	0	1
05:00 PM	0	2	0	0	2	0	0	0	0	0	0	0	0	0	0	0	0	0	0	0	0	2
05:15 PM	0	0	0	0	0	0	0	0	0	0	0	2	0	0	2	0	0	0	0	0	0	2
05:30 PM	0	1	0	0	1	0	0	0	0	0	0	1	0	0	1	0	0	0	0	0	0	2
Total Volume	0	4	0	0	4	0	0	0	0	0	0	3	0	0	3	0	0	0	0	0	0	7
% App. Total	0	100	0	0		0	0	0	0		0	100	0	0		0	0	0	0	0		
PHF	.000	.500	.000	.000	.500	.000	.000	.000	.000	.000	.000	.375	.000	.000	.375	.000	.000	.000	.000	.000	.000	.875

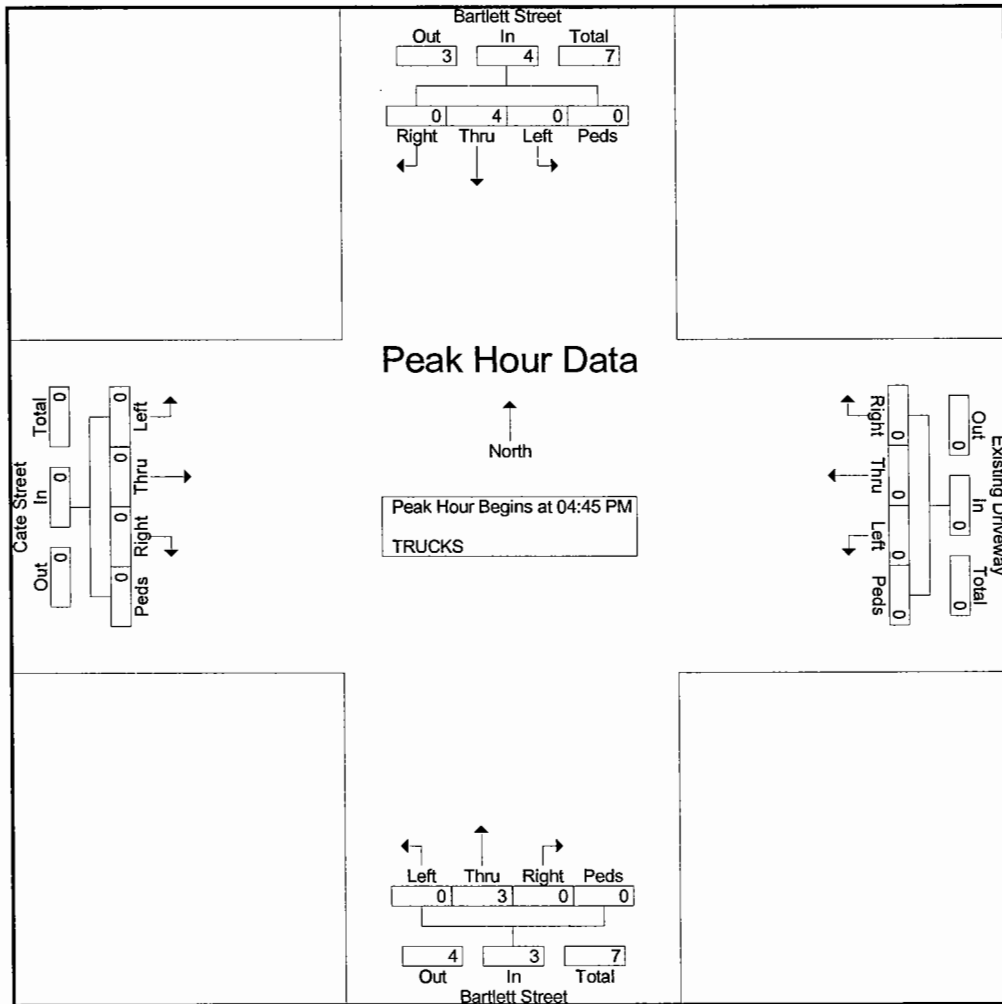

Stephen G. Pernaw & Co., Inc.
P.O. Box 1721
Concord, New Hampshire 03302

Weather: CLear
Collected By: MV
Job Number: 1821A
Town/State: Portsmouth, NH

File Name : 1821A_INT_B_PM_PH
Site Code : 1821A
Start Date : 4/5/2018
Page No : 1

Groups Printed- CARS - TRUCKS

Start Time	Bartlett Street From North					Existing Driveway From East					Bartlett Street From South					Cate Street From West					Int. Total
	Right	Thru	Left	Peds	App. Total	Right	Thru	Left	Peds	App. Total	Right	Thru	Left	Peds	App. Total	Right	Thru	Left	Peds	App. Total	
03:00 PM	8	100	0	0	108	1	0	0	0	1	1	99	6	0	106	9	0	2	0	11	226
03:15 PM	1	108	1	0	110	0	0	0	0	0	0	90	13	0	103	14	0	3	0	17	230
03:30 PM	3	105	0	0	108	1	0	0	0	1	0	93	13	0	106	12	0	2	0	14	229
03:45 PM	1	128	0	0	129	0	0	0	0	0	0	98	18	0	116	14	0	2	0	16	261
Total	13	441	1	0	455	2	0	0	0	2	1	380	50	0	431	49	0	9	0	58	946
04:00 PM	0	107	0	0	107	0	0	0	0	0	0	94	10	0	104	24	0	1	0	25	236
04:15 PM	1	146	0	0	147	1	0	0	0	1	1	98	19	0	118	8	0	2	0	10	276
04:30 PM	0	126	0	0	126	0	0	0	0	0	0	90	17	0	107	20	0	1	0	21	254
04:45 PM	0	136	0	0	136	0	0	0	0	0	0	115	14	0	129	12	0	0	0	12	277
Total	1	515	0	0	516	1	0	0	0	1	1	397	60	0	458	64	0	4	0	68	1043
05:00 PM	2	151	0	0	153	0	0	0	0	0	0	126	26	0	152	23	0	0	0	23	328
05:15 PM	5	153	0	0	158	0	0	0	0	0	0	115	18	0	133	19	0	2	0	21	312
05:30 PM	5	150	0	0	155	0	0	0	0	0	0	99	20	0	119	18	0	2	0	20	294
05:45 PM	6	111	0	0	117	0	0	0	0	0	0	89	11	0	100	16	0	2	0	18	235
Total	18	565	0	0	583	0	0	0	0	0	0	429	75	0	504	76	0	6	0	82	1169
Grand Total	32	1521	1	0	1554	3	0	0	0	3	2	1206	185	0	1393	189	0	19	0	208	3158
Apprch %	2.1	97.9	0.1	0		100	0	0	0		0.1	86.6	13.3	0		90.9	0	9.1	0		
Total %	1	48.2	0	0	49.2	0.1	0	0	0	0.1	0.1	38.2	5.9	0	44.1	6	0	0.6	0	6.6	
CARS	31	1505	0	0	1536	2	0	0	0	2	2	1189	183	0	1374	186	0	19	0	205	3117
% CARS	96.9	98.9	0	0	98.8	66.7	0	0	0	66.7	100	98.6	98.9	0	98.6	98.4	0	100	0	98.6	98.7
TRUCKS	1	16	1	0	18	1	0	0	0	1	0	17	2	0	19	3	0	0	0	3	41
% TRUCKS	3.1	1.1	100	0	1.2	33.3	0	0	0	33.3	0	1.4	1.1	0	1.4	1.6	0	0	0	1.4	1.3

Stephen G. Pernaw & Co., Inc.
P.O. Box 1721
Concord, New Hampshire 03302

Weather: Clear
Collected By: MV
Job Number: 1821A
Town/State: Portsmouth, NH

File Name : 1821A_INT_B_PM_PH
Site Code : 1821A
Start Date : 4/5/2018
Page No : 2

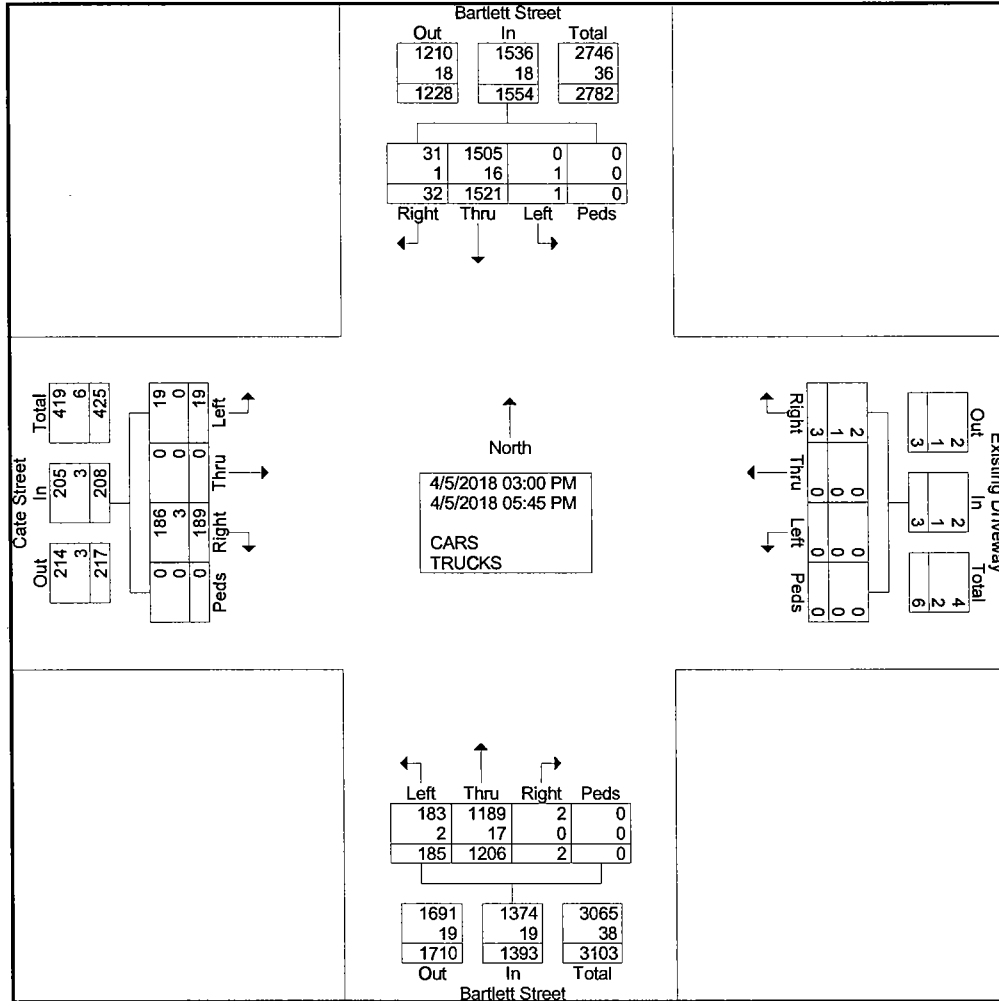

Stephen G. Pernaw & Co., Inc.
P.O. Box 1721
Concord, New Hampshire 03302

Weather: CLear
Collected By: MV
Job Number: 1821A
Town/State: Portsmouth, NH

File Name : 1821A_INT_B_PM_PH
Site Code : 1821A
Start Date : 4/5/2018
Page No : 1

Groups Printed- TRUCKS

Start Time	Bartlett Street From North					Existing Driveway From East					Bartlett Street From South					Cate Street From West					Int. Total					
	Right	Thru	Left	Peds	App. Total	Right	Thru	Left	Peds	App. Total	Right	Thru	Left	Peds	App. Total	Right	Thru	Left	Peds	App. Total						
03:00 PM	1	4	0	0	5	0	0	0	0	0	0	4	0	0	4	0	0	0	0	0	0	0	0	0	0	9
03:15 PM	0	0	1	0	1	0	0	0	0	0	0	1	0	0	1	2	0	0	0	0	0	0	0	0	2	4
03:30 PM	0	1	0	0	1	1	0	0	0	1	0	1	0	0	1	0	0	0	0	0	0	0	0	0	3	
03:45 PM	0	1	0	0	1	0	0	0	0	0	0	4	1	0	5	0	0	0	0	0	0	0	0	0	6	
Total	1	6	1	0	8	1	0	0	0	1	0	10	1	0	11	2	0	0	0	2	0	0	0	0	22	
04:00 PM	0	2	0	0	2	0	0	0	0	0	0	1	0	0	1	0	0	0	0	0	0	0	0	0	3	
04:15 PM	0	1	0	0	1	0	0	0	0	0	0	1	1	0	2	0	0	0	0	0	0	0	0	0	3	
04:30 PM	0	2	0	0	2	0	0	0	0	0	0	2	0	0	2	1	0	0	0	1	0	0	0	0	5	
04:45 PM	0	1	0	0	1	0	0	0	0	0	0	0	0	0	0	0	0	0	0	0	0	0	0	0	1	
Total	0	6	0	0	6	0	0	0	0	0	0	4	1	0	5	1	0	0	0	1	0	0	0	0	12	
05:00 PM	0	2	0	0	2	0	0	0	0	0	0	0	0	0	0	0	0	0	0	0	0	0	0	0	2	
05:15 PM	0	0	0	0	0	0	0	0	0	0	0	2	0	0	2	0	0	0	0	0	0	0	0	0	2	
05:30 PM	0	1	0	0	1	0	0	0	0	0	0	1	0	0	1	0	0	0	0	0	0	0	0	0	2	
05:45 PM	0	1	0	0	1	0	0	0	0	0	0	0	0	0	0	0	0	0	0	0	0	0	0	0	1	
Total	0	4	0	0	4	0	0	0	0	0	0	3	0	0	3	0	0	0	0	0	0	0	0	0	7	
Grand Total	1	16	1	0	18	1	0	0	0	1	0	17	2	0	19	3	0	0	0	3	0	0	0	0	41	
Apprch %	5.6	88.9	5.6	0		100	0	0	0		0	89.5	10.5	0		100	0	0	0		0	0	0	0		
Total %	2.4	39	2.4	0	43.9	2.4	0	0	0	2.4	0	41.5	4.9	0	46.3	7.3	0	0	0	7.3	0	0	0	0		

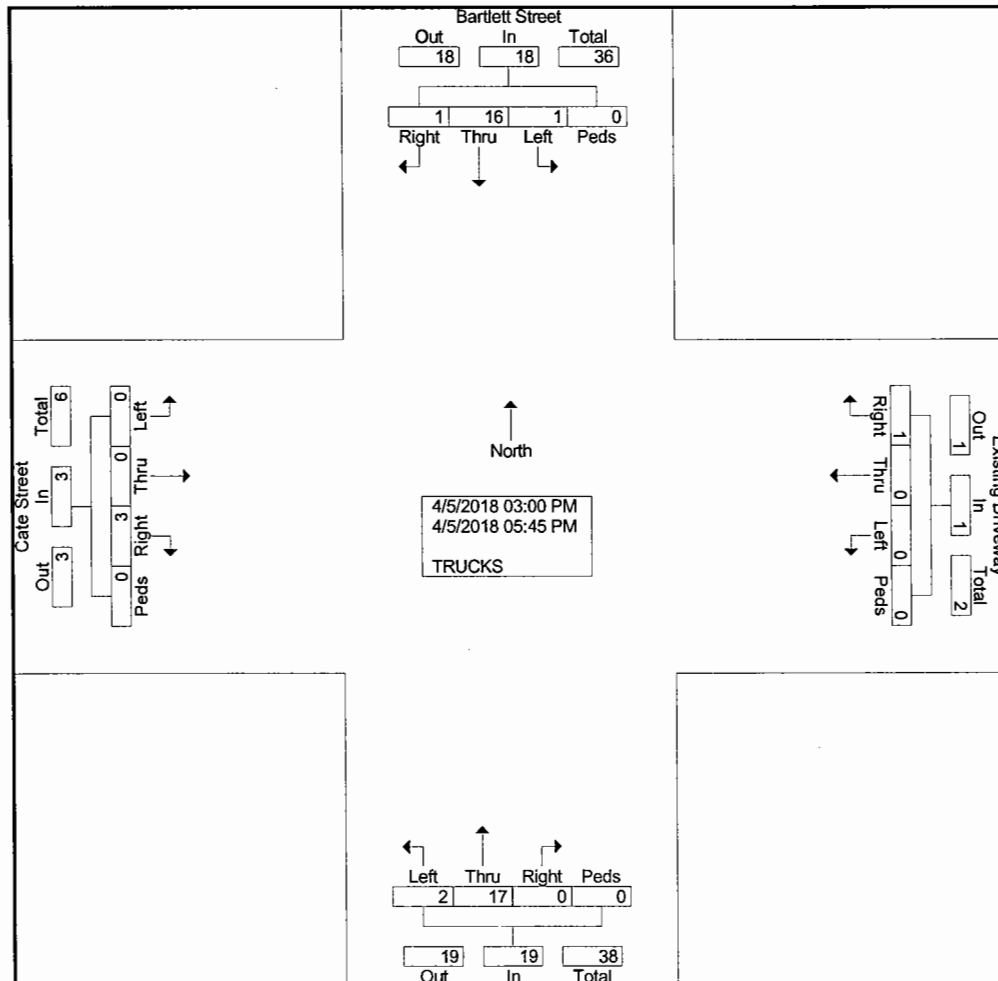

Stephen G. Pernaw & Co., Inc.
P.O. Box 1721
Concord, New Hampshire 03302

Weather: Clear
Collected By: MV
Job Number: 1821A
Town/State: Portsmouth, NH

File Name : 1821A_INT_C_AM_PH
Site Code : 1821A
Start Date : 4/5/2018
Page No : 2

Start Time	Islington Street From North				CVS Driveway From East				Islington Street From South				Bartlett Street From West				Int. Total
	Right	Thru	Left	App. Total	Right	Thru	Left	App. Total	Right	Thru	Left	App. Total	Right	Thru	Left	App. Total	
Peak Hour Analysis From 07:00 AM to 08:45 AM - Peak 1 of 1																	
Peak Hour for Entire Intersection Begins at 07:45 AM																	
07:45 AM	88	50	1	139	1	2	1	4	1	47	33	81	60	1	50	111	335
08:00 AM	73	46	0	119	0	2	0	2	1	46	32	79	46	7	60	113	313
08:15 AM	97	49	4	150	0	4	0	4	4	54	40	98	65	2	53	120	372
08:30 AM	76	48	2	126	1	2	1	4	4	52	27	83	41	10	43	94	307
Total Volume	334	193	7	534	2	10	2	14	10	199	132	341	212	20	206	438	1327
% App. Total	62.5	36.1	1.3		14.3	71.4	14.3		2.9	58.4	38.7		48.4	4.6	47		
PHF	.861	.965	.438	.890	.500	.625	.500	.875	.625	.921	.825	.870	.815	.500	.858	.913	.892

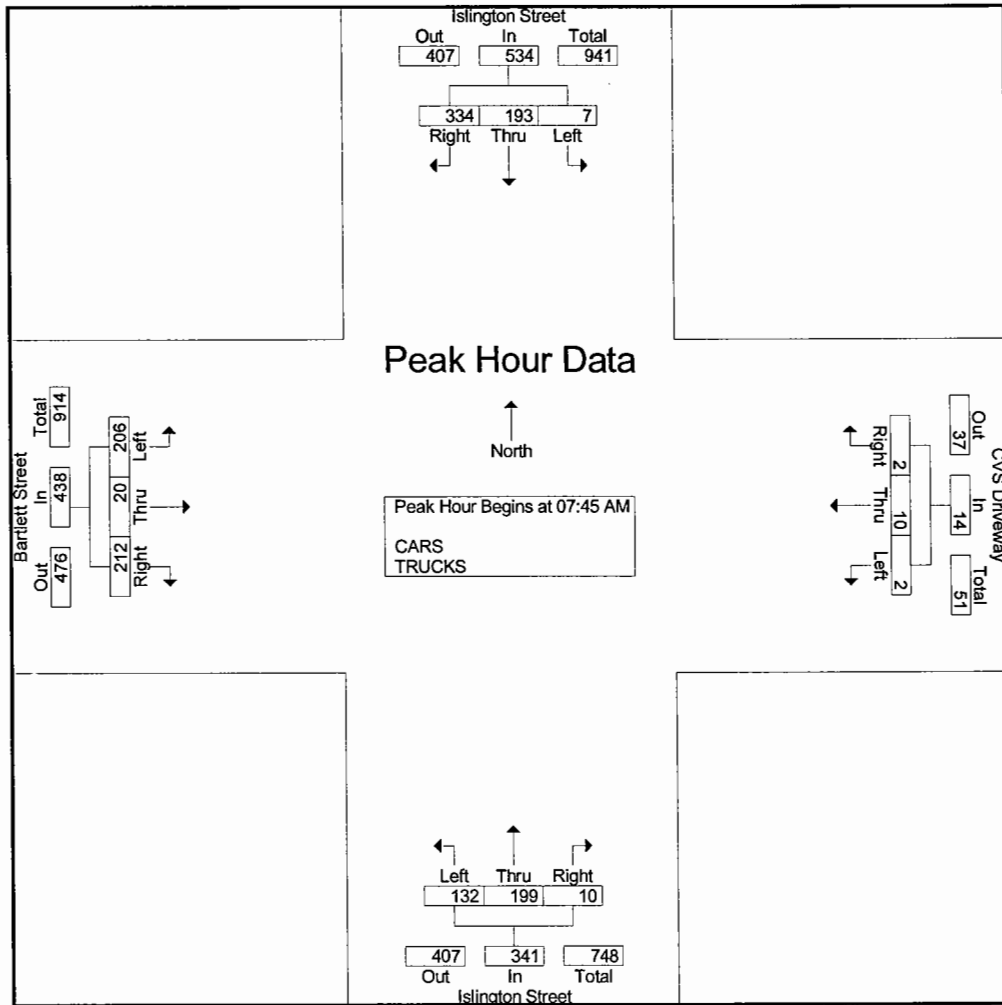

Stephen G. Pernaw & Co., Inc.
P.O. Box 1721
Concord, New Hampshire 03302

Weather: Clear
Collected By: MV
Job Number: 1821A
Town/State: Portsmouth, NH

File Name : 1821A_INT_C_AM_PH
Site Code : 1821A
Start Date : 4/5/2018
Page No : 2

Start Time	Islington Street From North				CVS Driveway From East				Islington Street From South				Bartlett Street From West				Int. Total
	Right	Thru	Left	App. Total	Right	Thru	Left	App. Total	Right	Thru	Left	App. Total	Right	Thru	Left	App. Total	
Peak Hour Analysis From 07:45 AM to 08:30 AM - Peak 1 of 1																	
Peak Hour for Entire Intersection Begins at 07:45 AM																	
07:45 AM	0	1	0	1	0	0	0	0	0	1	2	3	2	0	1	3	7
08:00 AM	0	2	0	2	0	1	0	1	0	2	2	4	1	1	2	4	11
08:15 AM	0	2	0	2	0	0	0	0	0	4	4	8	4	0	0	4	14
08:30 AM	1	2	1	4	0	0	0	0	0	2	0	2	1	1	1	3	9
Total Volume	1	7	1	9	0	1	0	1	0	9	8	17	8	2	4	14	41
% App. Total	11.1	77.8	11.1		0	100	0		0	52.9	47.1		57.1	14.3	28.6		
PHF	.250	.875	.250	.563	.000	.250	.000	.250	.000	.563	.500	.531	.500	.500	.500	.875	.732

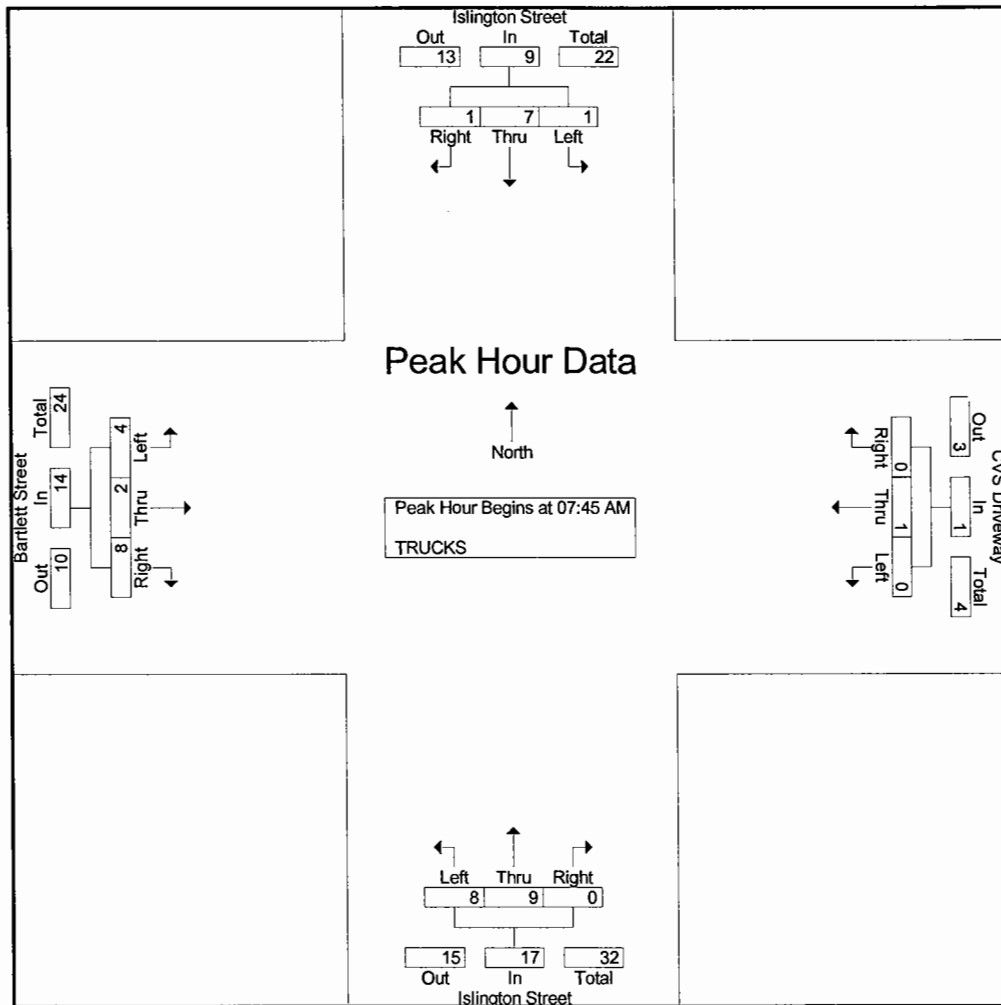

Stephen G. Pernaw & Co., Inc.
P.O. Box 1721
Concord, New Hampshire 03302

Weather: Clear
Collected By: MV
Job Number: 1821A
Town/State: Portsmouth, NH

File Name : 1821A_INT_C_AM_PH
Site Code : 1821A
Start Date : 4/5/2018
Page No : 1

Groups Printed- CARS - TRUCKS

Start Time	Islington Street From North					CVS Driveway From East					Islington Street From South					Bartlett Street From West					Exclu. Total	Inclu. Total	Int. Total
	Right	Thru	Left	Peds	App. Total	Right	Thru	Left	Peds	App. Total	Right	Thru	Left	Peds	App. Total	Right	Thru	Left	Peds	App. Total			
07:00 AM	61	22	0	0	83	0	0	0	0	0	0	13	14	0	27	34	0	24	0	58	0	168	168
07:15 AM	70	32	1	0	103	0	1	0	0	1	0	30	36	0	66	42	1	51	0	94	0	264	264
07:30 AM	85	55	0	0	140	0	0	0	0	0	0	31	24	0	55	49	1	45	0	95	0	290	290
07:45 AM	88	50	1	0	139	1	2	1	0	4	1	47	33	0	81	60	1	50	0	111	0	335	335
Total	304	159	2	0	465	1	3	1	0	5	1	121	107	0	229	185	3	170	0	358	0	1057	1057
08:00 AM	73	46	0	0	119	0	2	0	0	2	1	46	32	0	79	46	7	60	0	113	0	313	313
08:15 AM	97	49	4	0	150	0	4	0	0	4	4	54	40	0	98	65	2	53	0	120	0	372	372
08:30 AM	76	48	2	0	126	1	2	1	0	4	4	52	27	0	83	41	10	43	0	94	0	307	307
08:45 AM	75	44	3	0	122	4	1	1	0	6	4	35	29	0	68	61	1	61	0	123	0	319	319
Total	321	187	9	0	517	5	9	2	0	16	13	187	128	0	328	213	20	217	0	450	0	1311	1311
Grand Total	625	346	11	0	982	6	12	3	0	21	14	308	235	0	557	398	23	387	0	808	0	2368	2368
Apprch %	63.6	35.2	1.1			28.6	57.1	14.3			2.5	55.3	42.2			49.3	2.8	47.9					
Total %	26.4	14.6	0.5		41.5	0.3	0.5	0.1		0.9	0.6	13	9.9		23.5	16.8	1	16.3		34.1		0	100
CARS	618	332	10		960	6	11	3		20	14	296	223		533	383	21	381		785	0	0	2298
% CARS	98.9	96	90.9		97.8	100	91.7	100		95.2	100	96.1	94.9		95.7	96.2	91.3	98.4		97.2	0	0	97
TRUCKS	7	14	1		22	0	1	0		1	0	12	12		24	15	2	6		23	0	0	70
% TRUCKS	1.1	4	9.1		2.2	0	8.3	0		4.8	0	3.9	5.1		4.3	3.8	8.7	1.6		2.8	0	0	3

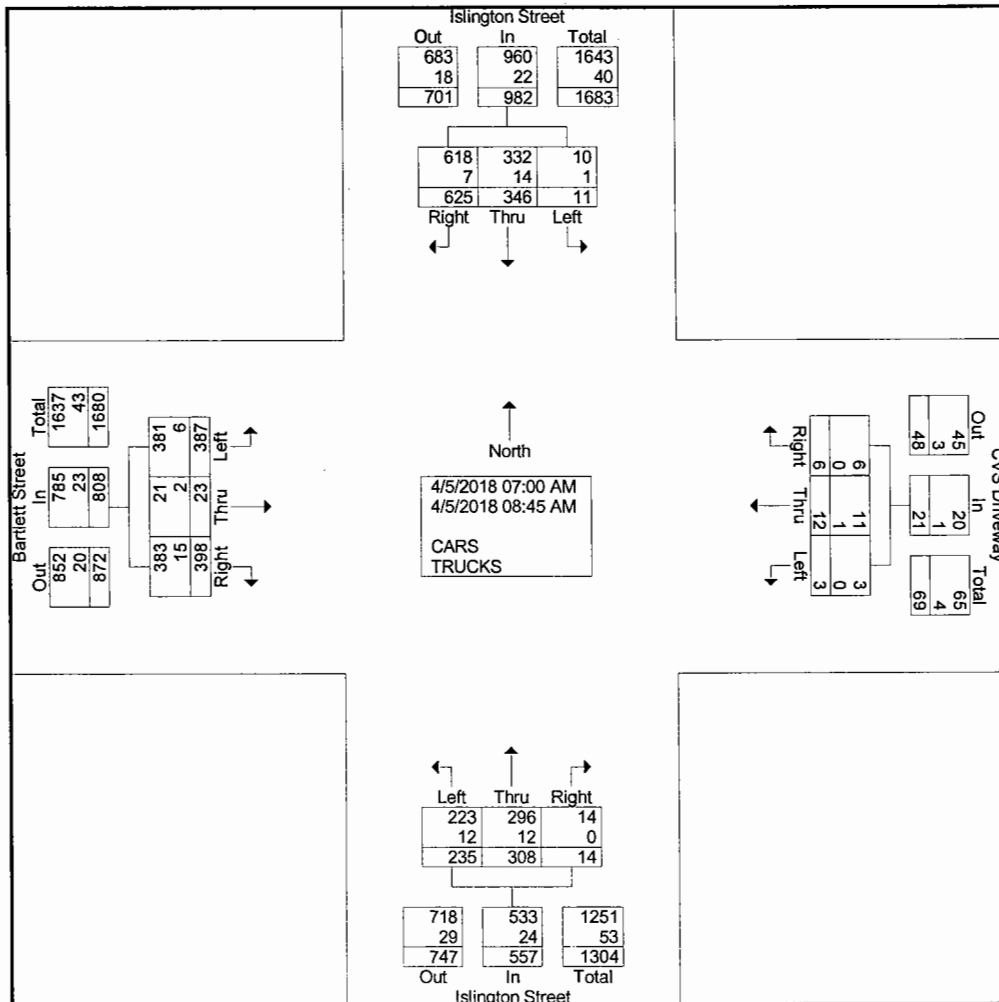

Stephen G. Pernaw & Co., Inc.
P.O. Box 1721
Concord, New Hampshire 03302

Weather: Clear
Collected By: MV
Job Number: 1821A
Town/State: Portsmouth, NH

File Name : 1821A_INT_C_AM_PH
Site Code : 1821A
Start Date : 4/5/2018
Page No : 1

Groups Printed- TRUCKS

Start Time	Islington Street From North					CVS Driveway From East					Islington Street From South					Bartlett Street From West					Exclu. Total	Inclu. Total	Int. Total
	Right	Thru	Left	Peds	App. Total	Right	Thru	Left	Peds	App. Total	Right	Thru	Left	Peds	App. Total	Right	Thru	Left	Peds	App. Total			
07:00 AM	0	0	0	0	0	0	0	0	0	0	0	0	0	0	0	3	0	1	0	4	0	4	4
07:15 AM	1	3	0	0	4	0	0	0	0	0	0	3	2	0	5	2	0	1	0	3	0	12	12
07:30 AM	1	2	0	0	3	0	0	0	0	0	0	0	0	0	0	2	0	0	0	2	0	5	5
07:45 AM	0	1	0	0	1	0	0	0	0	0	0	1	2	0	3	2	0	1	0	3	0	7	7
Total	2	6	0	0	8	0	0	0	0	0	0	4	4	0	8	9	0	3	0	12	0	28	28
08:00 AM	0	2	0	0	2	0	1	0	0	1	0	2	2	0	4	1	1	2	0	4	0	11	11
08:15 AM	0	2	0	0	2	0	0	0	0	0	0	4	4	0	8	4	0	0	0	4	0	14	14
08:30 AM	1	2	1	0	4	0	0	0	0	0	0	2	0	0	2	1	1	1	0	3	0	9	9
08:45 AM	4	2	0	0	6	0	0	0	0	0	0	0	2	0	2	0	0	0	0	0	0	8	8
Total	5	8	1	0	14	0	1	0	0	1	0	8	8	0	16	6	2	3	0	11	0	42	42
Grand Total	7	14	1	0	22	0	1	0	0	1	0	12	12	0	24	15	2	6	0	23	0	70	70
Apprch %	31.8	63.6	4.5			0	100	0			0	50	50			65.2	8.7	26.1					
Total %	10	20	1.4		31.4	0	1.4	0		1.4	0	17.1	17.1		34.3	21.4	2.9	8.6		32.9	0	100	

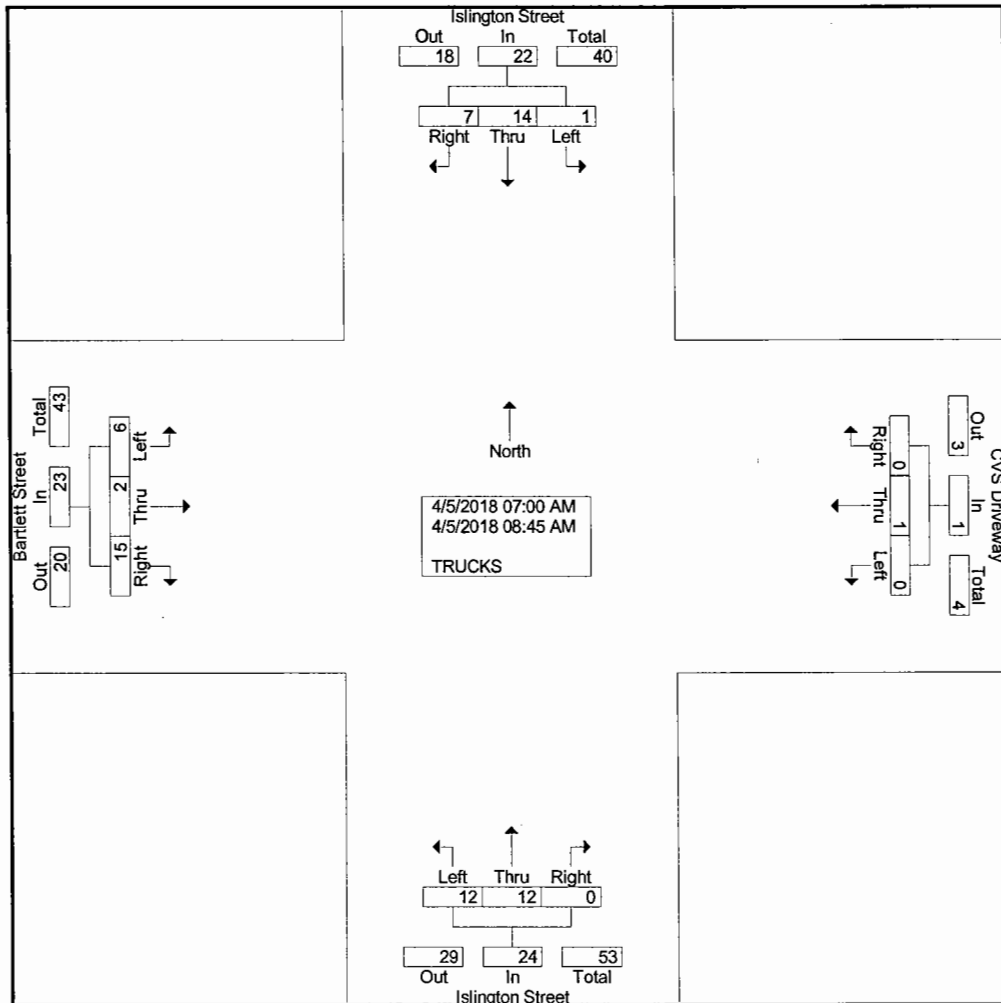

Stephen G. Pernaw & Co., Inc.
P.O. Box 1721
Concord, New Hampshire 03302

Weather: Clear
Collected By: MV
Job Number: 1821A
Town/State: Portsmouth, NH

File Name : 1821A_INT_C_PM_PH
Site Code : 1821A
Start Date : 4/5/2018
Page No : 3

Start Time	Islington Street From North					CVS Driveway From East					Islington Driveway From South					Bartlett Street From West					Int. Total
	Right	Thru	Left	Peds	App. Total	Right	Thru	Left	Peds	App. Total	Right	Thru	Left	Peds	App. Total	Right	Thru	Left	Peds	App. Total	
Peak Hour Analysis From 03:00 PM to 05:45 PM - Peak 1 of 1																					
Peak Hour for Entire Intersection Begins at 04:45 PM																					
04:45 PM	59	92	3	0	154	2	4	2	0	8	0	69	58	0	127	79	4	60	0	143	432
05:00 PM	72	77	7	0	156	3	5	0	0	8	1	52	60	0	113	89	1	79	0	169	446
05:15 PM	63	79	4	0	146	4	4	2	0	10	7	68	64	0	139	80	7	80	0	167	462
05:30 PM	47	61	4	0	112	3	8	6	0	17	3	55	60	0	118	72	6	93	0	171	418
Total Volume	241	309	18	0	568	12	21	10	0	43	11	244	242	0	497	320	18	312	0	650	1758
% App. Total	42.4	54.4	3.2	0		27.9	48.8	23.3	0		2.2	49.1	48.7	0		49.2	2.8	48	0		
PHF	.837	.840	.643	.000	.910	.750	.656	.417	.000	.632	.393	.884	.945	.000	.894	.899	.643	.839	.000	.950	.951

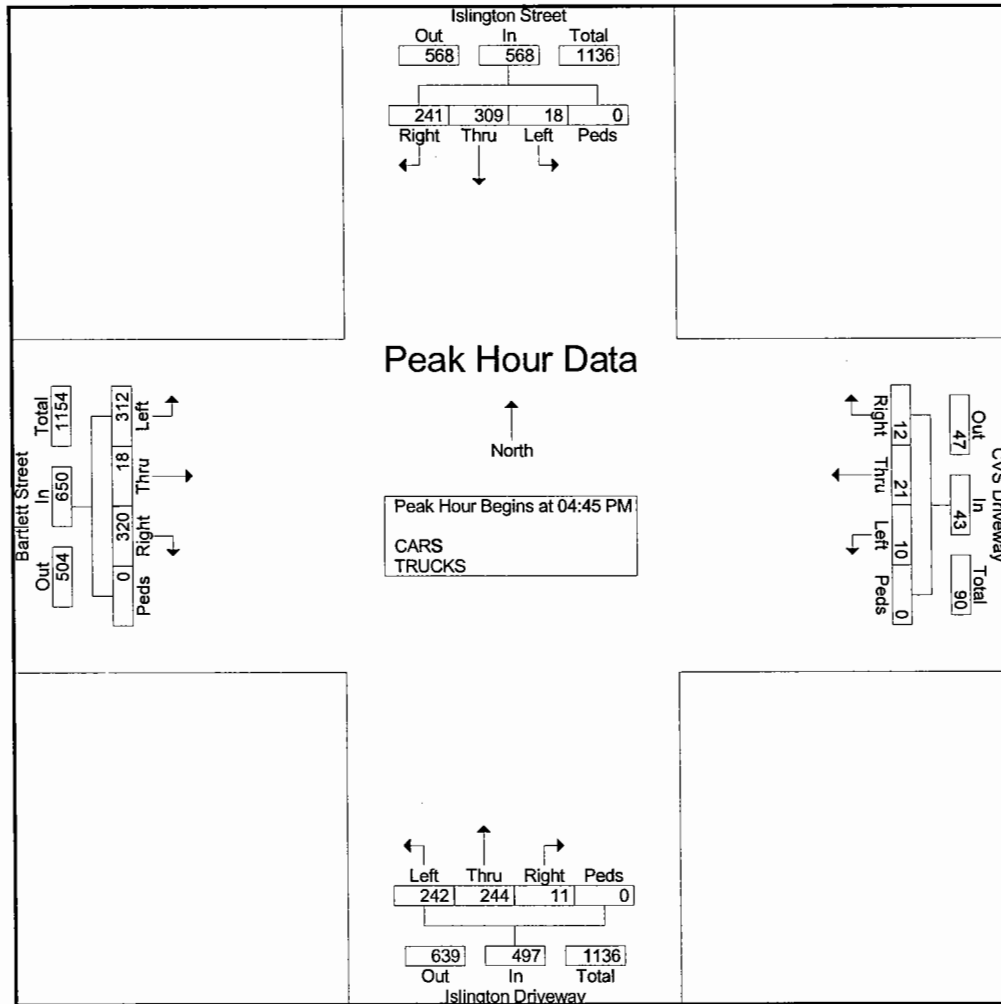

Stephen G. Pernaw & Co., Inc.
P.O. Box 1721
Concord, New Hampshire 03302

Weather: Clear
Collected By: MV
Job Number: 1821A
Town/State: Portsmouth, NH

File Name : 1821A_INT_C_PM_PH
Site Code : 1821A
Start Date : 4/5/2018
Page No : 2

Start Time	Islington Street From North					CVS Driveway From East					Islington Driveway From South					Bartlett Street From West					Int. Total
	Right	Thru	Left	Peds	App. Total	Right	Thru	Left	Peds	App. Total	Right	Thru	Left	Peds	App. Total	Right	Thru	Left	Peds	App. Total	
Peak Hour Analysis From 04:45 PM to 05:30 PM - Peak 1 of 1																					
Peak Hour for Entire Intersection Begins at 04:45 PM																					
04:45 PM	0	0	0	0	0	0	0	0	0	0	0	1	0	0	1	0	0	1	0	1	2
05:00 PM	0	1	0	0	1	0	0	0	0	0	0	0	0	0	0	2	0	0	0	2	3
05:15 PM	0	2	0	0	2	0	0	0	0	0	0	2	2	0	4	0	0	0	0	0	6
05:30 PM	0	1	0	0	1	0	0	0	0	0	0	0	1	0	1	1	0	0	0	1	3
Total Volume	0	4	0	0	4	0	0	0	0	0	0	3	3	0	6	3	0	1	0	4	14
% App. Total	0	100	0	0		0	0	0	0		0	50	50	0		75	0	25	0		
PHF	.000	.500	.000	.000	.500	.000	.000	.000	.000	.000	.000	.375	.375	.000	.375	.375	.000	.250	.000	.500	.583

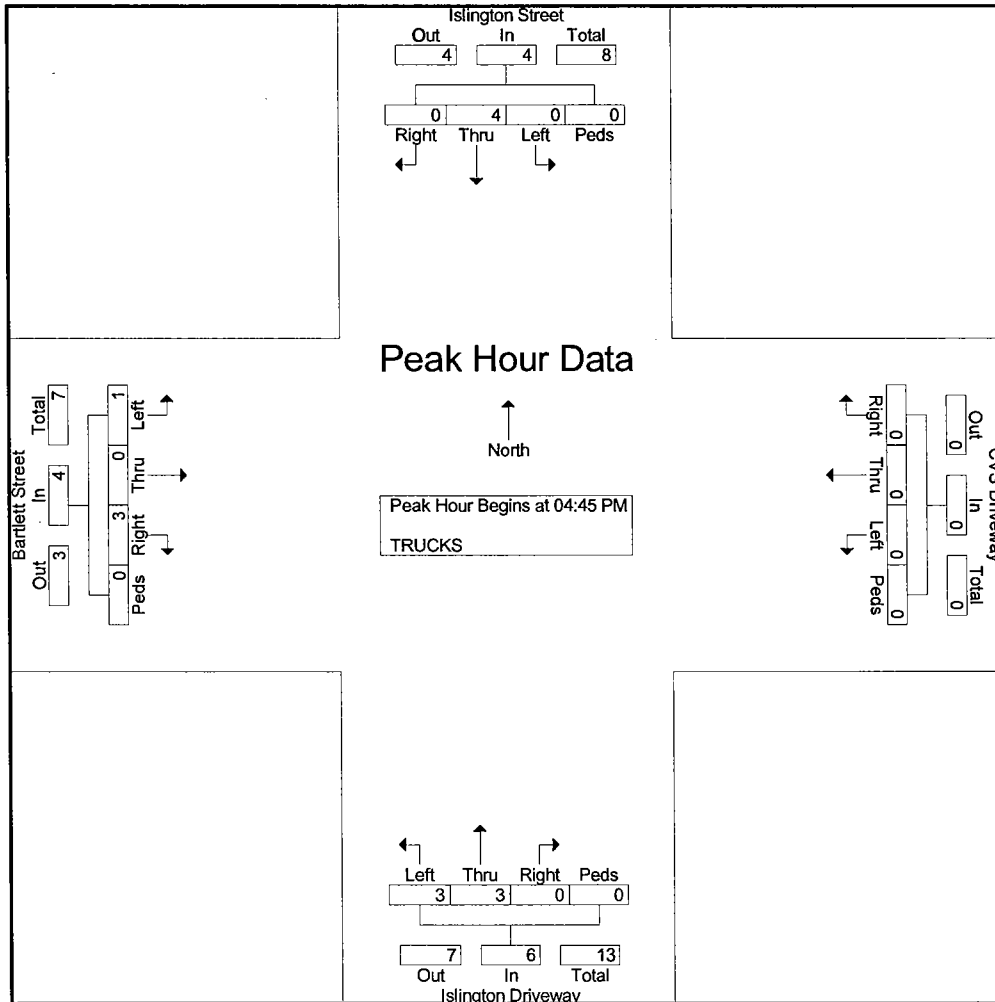

Stephen G. Pernaw & Co., Inc.
P.O. Box 1721
Concord, New Hampshire 03302

Weather: Clear
Collected By: MV
Job Number: 1821A
Town/State: Portsmouth, NH

File Name : 1821A_INT_C_PM_PH
Site Code : 1821A
Start Date : 4/5/2018
Page No : 1

Groups Printed- CARS - TRUCKS

Start Time	Islington Street From North					CVS Driveway From East					Islington Driveway From South					Bartlett Street From West					Int. Total
	Right	Thru	Left	Peds	App. Total	Right	Thru	Left	Peds	App. Total	Right	Thru	Left	Peds	App. Total	Right	Thru	Left	Peds	App. Total	
03:00 PM	63	70	5	0	138	3	0	0	0	3	1	50	41	0	92	65	2	46	0	113	346
03:15 PM	57	62	3	0	122	1	3	4	0	8	2	56	45	0	103	60	2	50	0	112	345
03:30 PM	44	71	1	0	116	3	4	2	0	9	2	46	57	0	105	44	2	70	0	116	346
03:45 PM	63	61	1	0	125	7	3	0	0	10	3	48	52	0	103	66	4	67	0	137	375
Total	227	264	10	0	501	14	10	6	0	30	8	200	195	0	403	235	10	233	0	478	1412
04:00 PM	56	79	4	0	139	2	4	1	0	7	0	48	45	0	93	61	5	62	0	128	367
04:15 PM	64	67	0	0	131	3	3	1	0	7	0	58	47	0	105	70	9	74	0	153	396
04:30 PM	54	64	1	0	119	4	3	3	0	10	3	53	47	0	103	84	2	57	0	143	375
04:45 PM	59	92	3	0	154	2	4	2	0	8	0	69	58	0	127	79	4	60	0	143	432
Total	233	302	8	0	543	11	14	7	0	32	3	228	197	0	428	294	20	253	0	567	1570
05:00 PM	72	77	7	0	156	3	5	0	0	8	1	52	60	0	113	89	1	79	0	169	446
05:15 PM	63	79	4	0	146	4	4	2	0	10	7	68	64	0	139	80	7	80	0	167	462
05:30 PM	47	61	4	0	112	3	8	6	0	17	3	55	60	0	118	72	6	93	0	171	418
05:45 PM	40	60	2	0	102	4	5	2	0	11	0	55	50	0	105	50	4	74	0	128	346
Total	222	277	17	0	516	14	22	10	0	46	11	230	234	0	475	291	18	326	0	635	1672
Grand Total	682	843	35	0	1560	39	46	23	0	108	22	658	626	0	1306	820	48	812	0	1680	4654
Approch %	43.7	54	2.2	0		36.1	42.6	21.3	0		1.7	50.4	47.9	0		48.8	2.9	48.3	0		
Total %	14.7	18.1	0.8	0	33.5	0.8	1	0.5	0	2.3	0.5	14.1	13.5	0	28.1	17.6	1	17.4	0	36.1	
CARS	678	828	35	0	1541	39	46	23	0	108	22	646	614	0	1282	806	48	806	0	1660	4591
% CARS	99.4	98.2	100	0	98.8	100	100	100	0	100	100	98.2	98.1	0	98.2	98.3	100	99.3	0	98.8	98.6
TRUCKS	4	15	0	0	19	0	0	0	0	0	0	12	12	0	24	14	0	6	0	20	63
% TRUCKS	0.6	1.8	0	0	1.2	0	0	0	0	0	0	1.8	1.9	0	1.8	1.7	0	0.7	0	1.2	1.4

Stephen G. Pernaw & Co., Inc.
P.O. Box 1721
Concord, New Hampshire 03302

Weather: Clear
Collected By: MV
Job Number: 1821A
Town/State: Portsmouth, NH

File Name : 1821A_INT_C_PM_PH
Site Code : 1821A
Start Date : 4/5/2018
Page No : 2

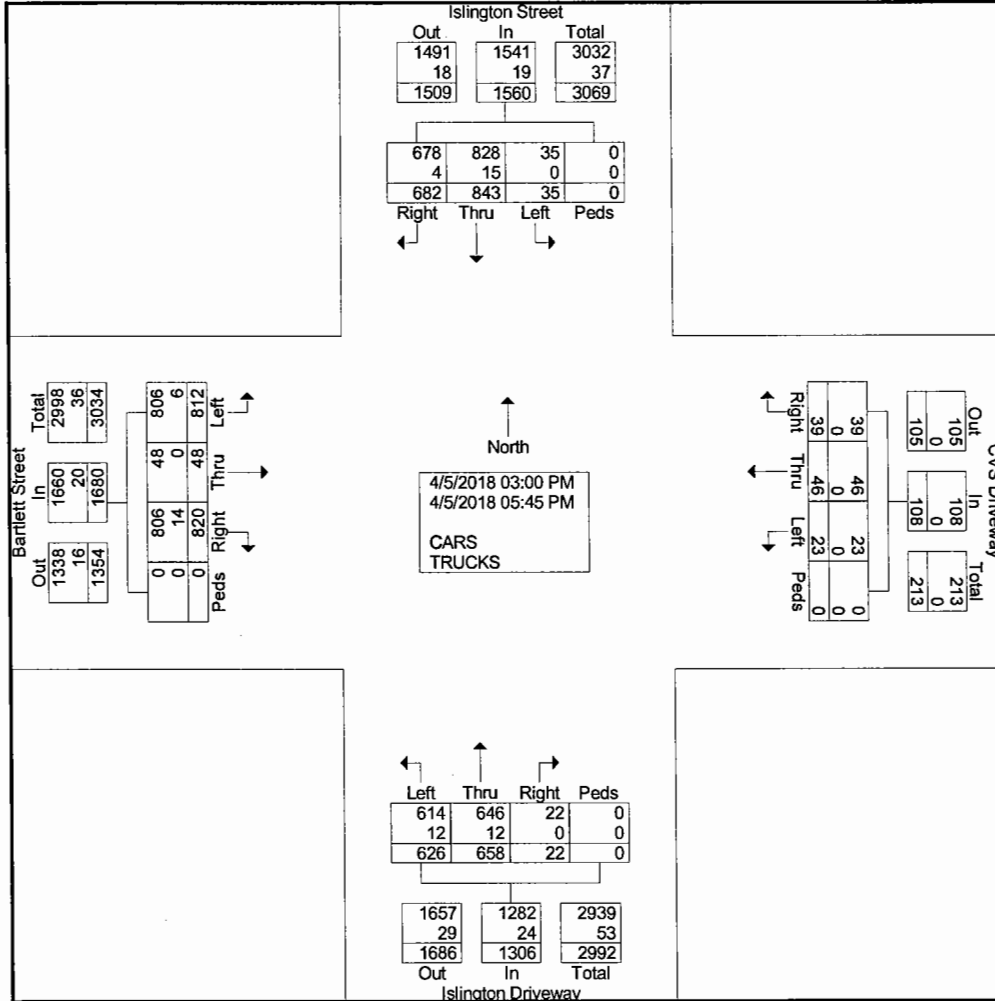

Stephen G. Pernaw & Co., Inc.
P.O. Box 1721
Concord, New Hampshire 03302

Weather: Clear
Collected By: MV
Job Number: 1821A
Town/State: Portsmouth, NH

File Name : 1821A_INT_C_PM_PH
Site Code : 1821A
Start Date : 4/5/2018
Page No : 1

Groups Printed- TRUCKS

Start Time	Islington Street From North					CVS Driveway From East					Islington Driveway From South					Bartlett Street From West					Int. Total	
	Right	Thru	Left	Peds	App. Total	Right	Thru	Left	Peds	App. Total	Right	Thru	Left	Peds	App. Total	Right	Thru	Left	Peds	App. Total		
03:00 PM	1	2	0	0	3	0	0	0	0	0	0	2	2	0	4	4	0	0	0	4		
03:15 PM	1	1	0	0	2	0	0	0	0	0	0	1	0	0	1	2	0	0	0	2		
03:30 PM	0	2	0	0	2	0	0	0	0	0	0	0	1	0	1	0	0	1	0	1		
03:45 PM	1	1	0	0	2	0	0	0	0	0	0	1	3	0	4	0	0	1	0	1		
Total	3	6	0	0	9	0	0	0	0	0	0	4	6	0	10	6	0	2	0	8		27
04:00 PM	0	1	0	0	1	0	0	0	0	0	0	0	1	0	1	1	0	1	0	2		
04:15 PM	0	3	0	0	3	0	0	0	0	0	0	2	1	0	3	0	0	2	0	2		
04:30 PM	1	1	0	0	2	0	0	0	0	0	0	2	1	0	3	3	0	0	0	3		
04:45 PM	0	0	0	0	0	0	0	0	0	0	0	1	0	0	1	0	0	1	0	1		
Total	1	5	0	0	6	0	0	0	0	0	0	5	3	0	8	4	0	4	0	8		22
05:00 PM	0	1	0	0	1	0	0	0	0	0	0	0	0	0	0	2	0	0	0	2		
05:15 PM	0	2	0	0	2	0	0	0	0	0	0	2	2	0	4	0	0	0	0	0		
05:30 PM	0	1	0	0	1	0	0	0	0	0	0	0	1	0	1	1	0	0	0	1		
05:45 PM	0	0	0	0	0	0	0	0	0	0	0	1	0	0	1	1	0	0	0	1		
Total	0	4	0	0	4	0	0	0	0	0	0	3	3	0	6	4	0	0	0	4		14
Grand Total	4	15	0	0	19	0	0	0	0	0	0	12	12	0	24	14	0	6	0	20		63
Apprch %	21.1	78.9	0	0		0	0	0	0		0	50	50	0		70	0	30	0			
Total %	6.3	23.8	0	0	30.2	0	0	0	0		0	19	19	0	38.1	22.2	0	9.5	0	31.7		

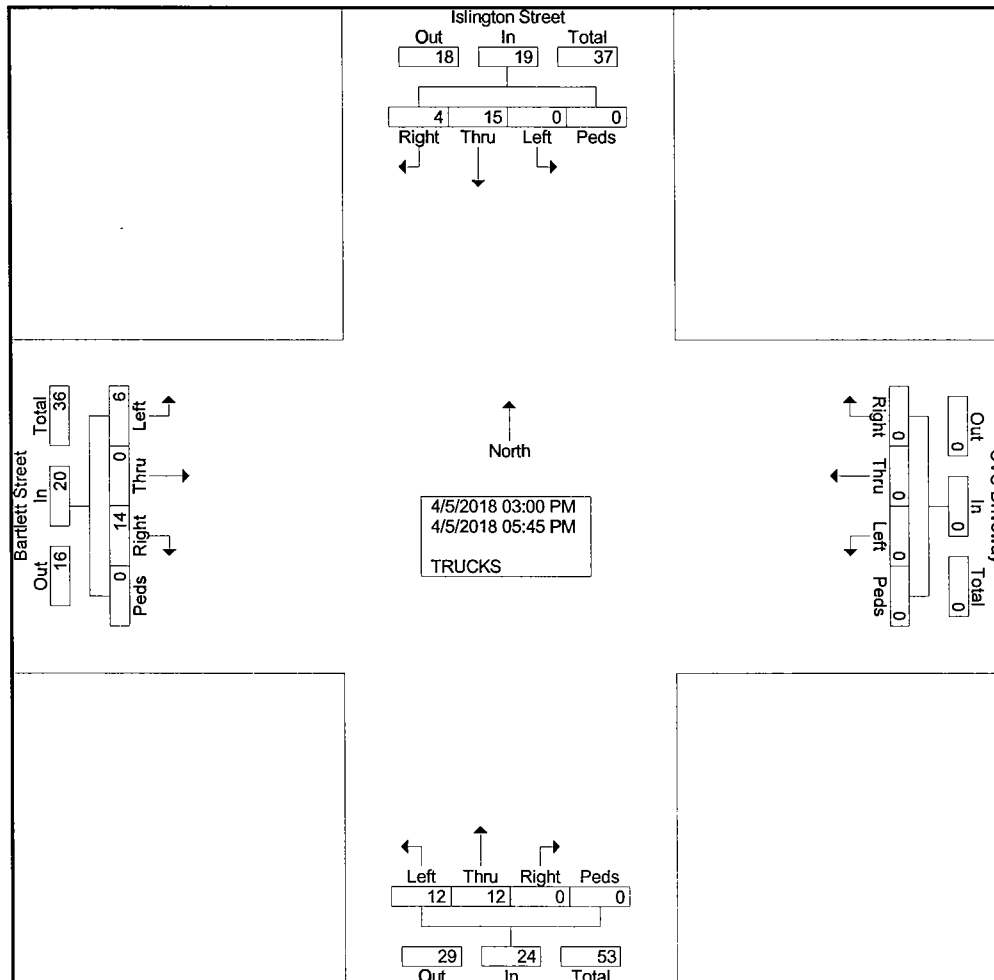

Stephen G. Pernaw & Co., Inc.
P.O. Box 1721
Concord, New Hampshire 03302

Weather: Clear
Collected By: MV
Job Number: 1821A
Town/State: Portsmouth, NH

File Name : 1821A_INT_A_AM_PH
Site Code : 1821A
Start Date : 4/5/2018
Page No : 1

Groups Printed- Bicycles on Crosswalk - Pedestrians

Start Time	Bartlett Street From North				Existing Shared Driveway From East				Bartlett Street From South				Exclu. Total	Inclu. Total	Int. Total
	Thru	Left	Peds	App. Total	Right	Left	Peds	App. Total	Right	Thru	Peds	App. Total			
07:00 AM	0	0	0	0	0	0	2	0	0	0	0	0	2	0	2
07:15 AM	0	0	0	0	0	0	0	0	0	0	0	0	0	0	0
07:30 AM	0	0	0	0	0	0	2	0	0	0	0	0	2	0	2
07:45 AM	0	0	0	0	0	0	0	0	0	0	0	0	0	0	0
Total	0	0	0	0	0	0	2	0	0	0	0	0	4	0	4
08:00 AM	0	0	0	0	0	0	0	0	0	0	0	0	0	0	0
08:15 AM	0	0	0	0	0	0	0	0	0	0	0	0	0	0	0
08:30 AM	0	0	0	0	0	0	0	0	0	0	0	0	0	0	0
08:45 AM	0	0	0	0	0	0	0	0	0	0	0	0	0	0	0
Total	0	0	0	0	0	0	0	0	0	0	0	0	0	0	0
Grand Total	0	0	0	0	0	0	4	0	0	0	0	0	4	0	4
Apprch %	0	0			0	0			0	0					
Total %													100	0	
Bicycles on Crosswalk													0	0	0
% Bicycles on Crosswalk	0	0	0	0	0	0	0	0	0	0	0	0	0	0	0
Pedestrians													0	0	4
% Pedestrians	0	0	0	0	0	0	100	100	0	0	0	0	0	0	100

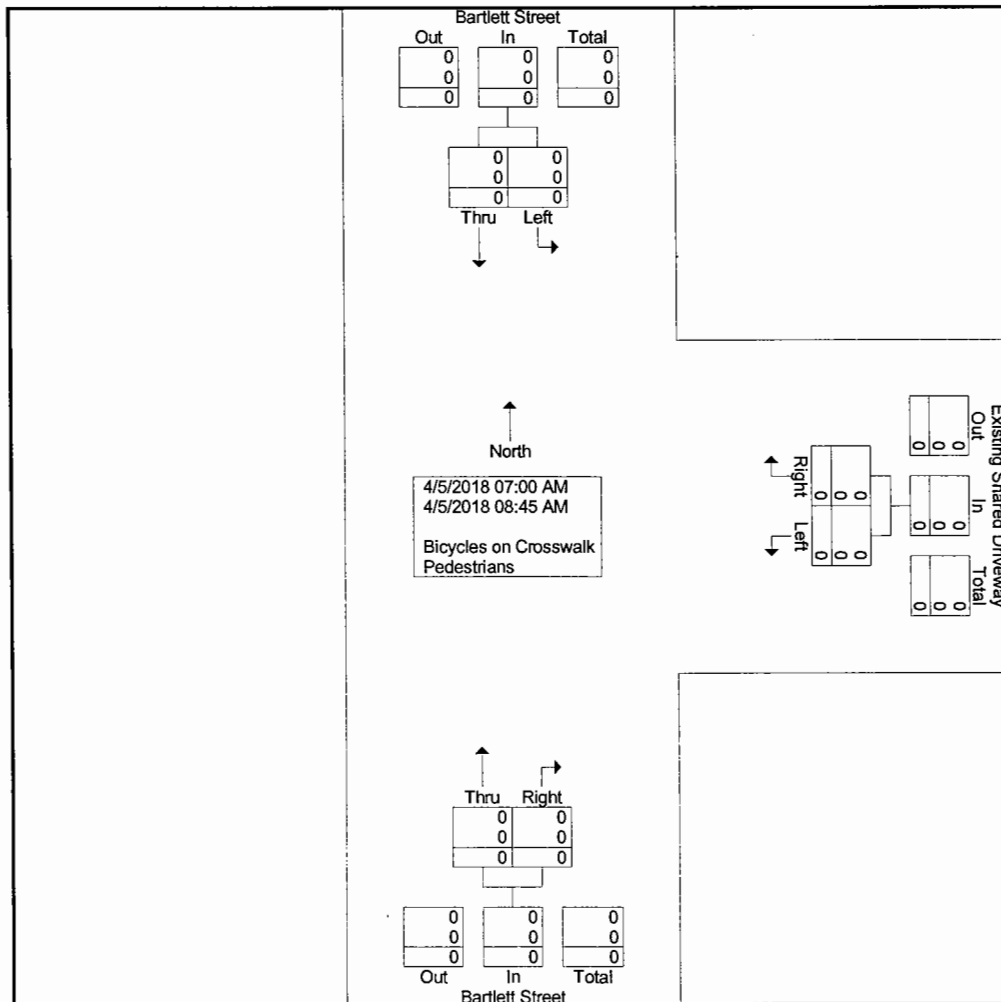

Stephen G. Pernaw & Co., Inc.
P.O. Box 1721
Concord, New Hampshire 03302

Weather: Clear
Collected By: MV
Job Number: 1821A
Town/State: Portsmouth, NH

File Name : 1821A_INT_A_PM_PH
Site Code : 1821A
Start Date : 4/5/2018
Page No : 3

Start Time	Bartlett Street From North				Existing Shared Driveway From East				Bartlett Street From South				Int. Total
	Thru	Left	Peds	App. Total	Right	Left	Peds	App. Total	Right	Thru	Peds	App. Total	
Peak Hour Analysis From 04:45 PM to 05:30 PM - Peak 1 of 1													
Peak Hour for Entire Intersection Begins at 04:45 PM													
04:45 PM	0	0	0	0	0	0	0	0	0	0	0	0	0
05:00 PM	0	0	0	0	0	0	0	0	0	0	0	0	0
05:15 PM	0	0	0	0	0	0	4	4	0	0	0	0	4
05:30 PM	0	0	0	0	0	0	2	2	0	0	0	0	2
Total Volume	0	0	0	0	0	0	6	6	0	0	0	0	6
% App. Total	0	0	0	0	0	0	100		0	0	0	0	
PHF	.000	.000	.000	.000	.000	.000	.375	.375	.000	.000	.000	.000	.375

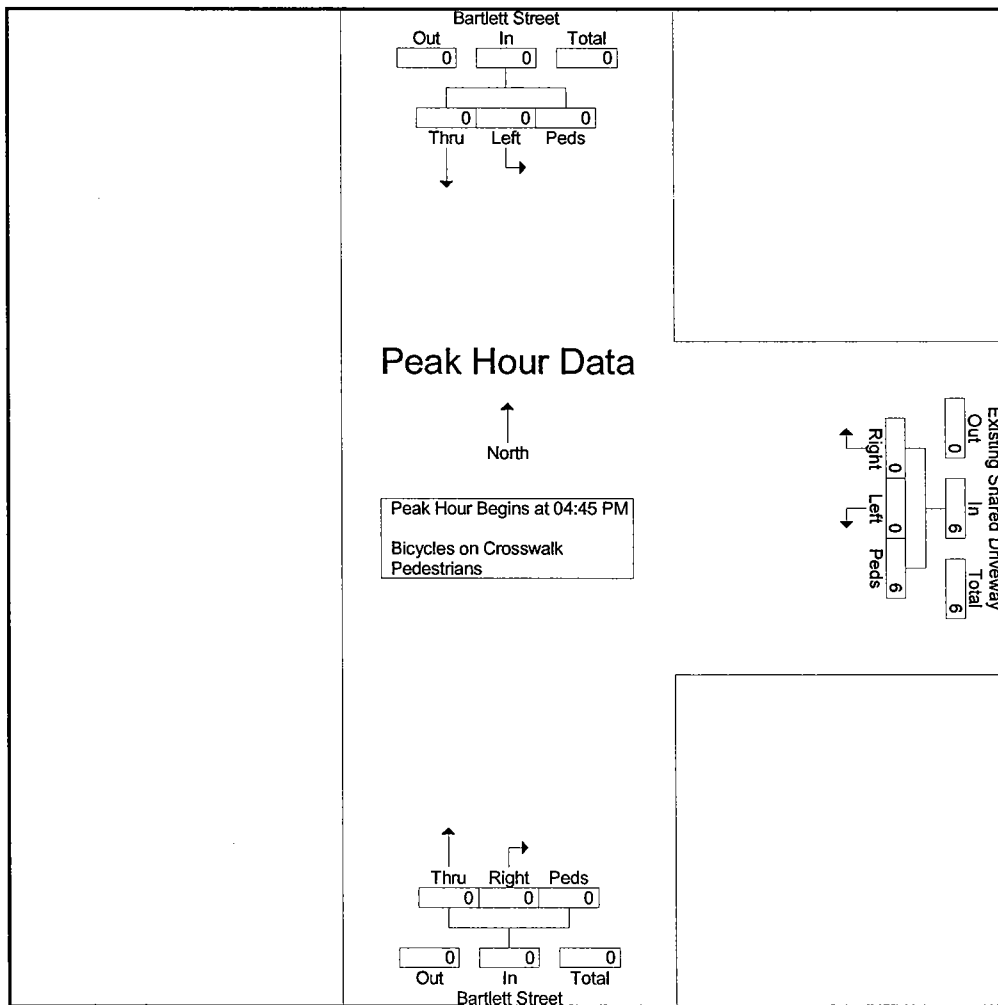

Stephen G. Pernaw & Co., Inc.
P.O. Box 1721
Concord, New Hampshire 03302

Weather: Clear
Collected By: MV
Job Number: 1821A
Town/State: Portsmouth, NH

File Name : 1821A_INT_B_AM_PH
Site Code : 1821A
Start Date : 4/5/2018
Page No : 2

Start Time	Bartlett Street From North					Existing Driveway From East					Bartlett Street From South					Cate Street From West					Int. Total
	Right	Thru	Left	Peds	App. Total	Right	Thru	Left	Peds	App. Total	Right	Thru	Left	Peds	App. Total	Right	Thru	Left	Peds	App. Total	
Peak Hour Analysis From 08:00 AM to 08:45 AM - Peak 1 of 1																					
Peak Hour for Entire Intersection Begins at 08:00 AM																					
08:00 AM	0	0	0	0	0	0	0	0	0	0	0	0	0	0	0	0	0	0	1	1	1
08:15 AM	0	0	0	1	1	0	0	0	2	2	0	0	0	1	1	0	0	0	0	0	4
08:30 AM	0	0	0	1	1	0	0	0	2	2	0	0	0	0	0	0	0	0	1	1	4
08:45 AM	0	0	0	0	0	0	0	0	1	1	0	0	0	0	0	0	0	0	0	0	1
Total Volume	0	0	0	2	2	0	0	0	5	5	0	0	0	1	1	0	0	0	2	2	10
% App. Total	0	0	0	100		0	0	0	100		0	0	0	100		0	0	0	100		
PHF	.000	.000	.000	.500	.500	.000	.000	.000	.625	.625	.000	.000	.000	.250	.250	.000	.000	.000	.500	.500	.625

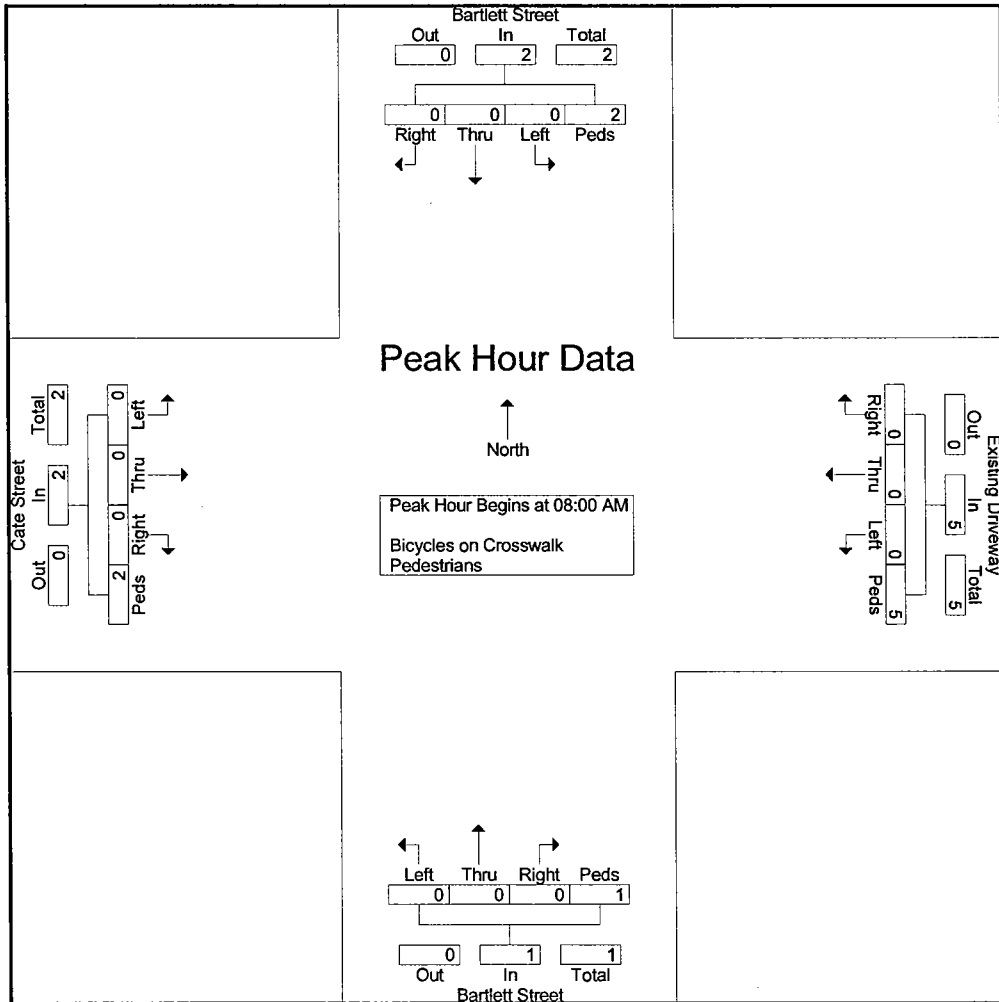

Stephen G. Pernaw & Co., Inc.
P.O. Box 1721
Concord, New Hampshire 03302

Weather: CLear
Collected By: MV
Job Number: 1821A
Town/State: Portsmouth, NH

File Name : 1821A_INT_B_PM_PH
Site Code : 1821A
Start Date : 4/5/2018
Page No : 3

Start Time	Bartlett Street From North					Existing Driveway From East					Bartlett Street From South					Cate Street From West					Int. Total	
	Right	Thru	Left	Peds	App. Total	Right	Thru	Left	Peds	App. Total	Right	Thru	Left	Peds	App. Total	Right	Thru	Left	Peds	App. Total		
Peak Hour Analysis From 04:45 PM to 05:30 PM - Peak 1 of 1																						
Peak Hour for Entire Intersection Begins at 04:45 PM																						
04:45 PM	0	0	0	0	0	0	0	0	3	3	0	0	0	0	0	0	0	0	0	0	0	3
05:00 PM	0	0	0	0	0	0	0	0	2	2	0	0	0	0	0	0	0	0	2	2	0	4
05:15 PM	0	0	0	0	0	0	0	0	5	5	0	0	0	0	0	0	0	0	0	0	0	5
05:30 PM	0	0	0	0	0	0	0	0	2	2	0	0	0	0	0	0	0	0	0	0	0	2
Total Volume	0	0	0	0	0	0	0	0	12	12	0	0	0	0	0	0	0	0	2	2	0	14
% App. Total	0	0	0	0	0	0	0	0	100	100	0	0	0	0	0	0	0	0	100	100	0	
PHF	.000	.000	.000	.000	.000	.000	.000	.000	.600	.600	.000	.000	.000	.000	.000	.000	.000	.000	.250	.250	.700	

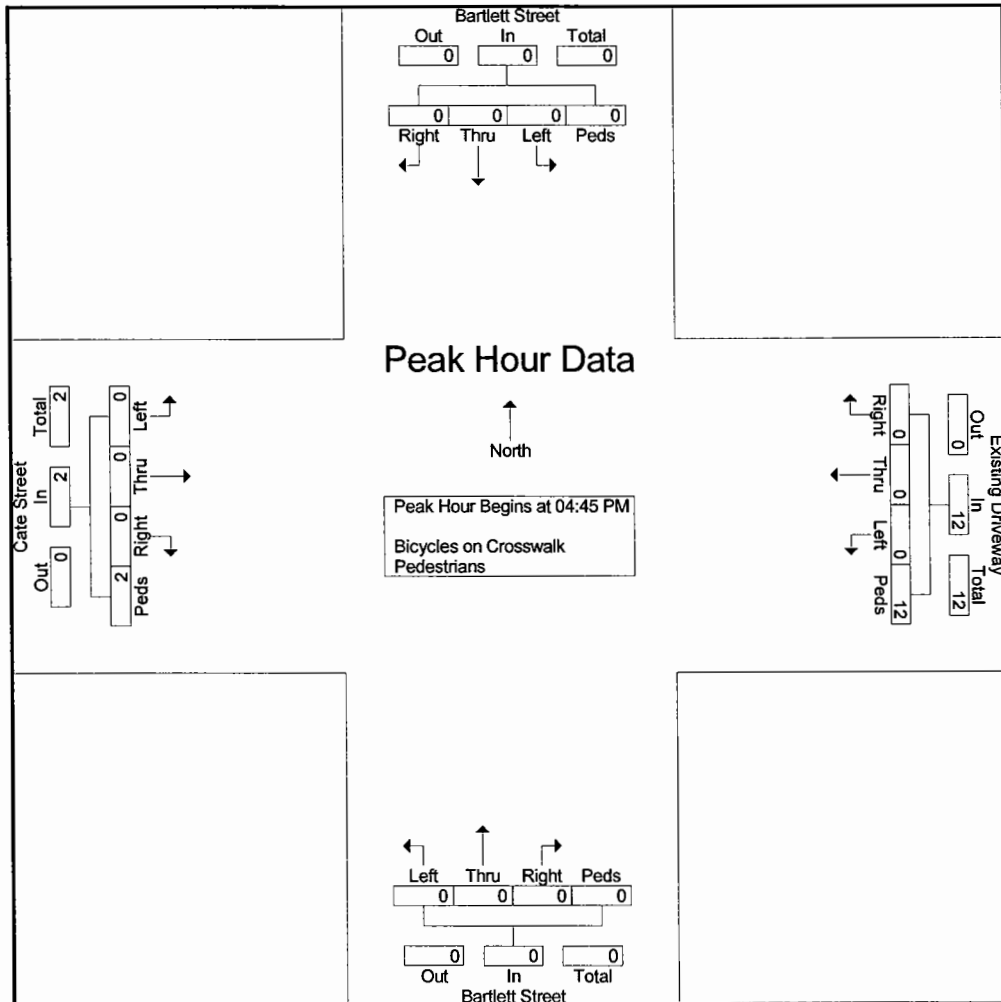

Stephen G. Pernaw & Co., Inc.
P.O. Box 1721
Concord, New Hampshire 03302

Weather: Clear
Collected By: MV
Job Number: 1821A
Town/State: Portsmouth, NH

File Name : 1821A_INT_C_AM_PH
Site Code : 1821A
Start Date : 4/5/2018
Page No : 1

Groups Printed- Bicycles on Crosswalk - Pedestrians

Start Time	Islington Street From North					CVS Driveway From East					Islington Street From South					Bartlett Street From West					Exclu. Total	Inclu. Total	Int. Total					
	Right	Thru	Left	Peds	App. Total	Right	Thru	Left	Peds	App. Total	Right	Thru	Left	Peds	App. Total	Right	Thru	Left	Peds	App. Total								
07:00 AM	0	0	0	0	0	0	0	0	0	0	0	0	0	0	0	0	0	0	0	0	0	0	0	0	0	1	0	1
07:15 AM	0	0	0	0	0	0	0	0	1	0	0	0	0	0	0	0	0	0	0	0	0	0	0	0	0	1	0	1
07:30 AM	0	0	0	1	0	0	0	0	1	0	0	0	0	0	0	0	0	0	0	0	0	0	0	0	0	2	0	2
07:45 AM	0	0	0	0	0	0	0	0	1	0	0	0	0	0	0	0	0	0	0	0	0	0	0	0	0	1	0	1
Total	0	0	0	0	0	0	0	0	1	0	0	0	0	0	0	0	0	0	0	0	0	0	0	0	0	5	0	5
08:00 AM	0	0	0	0	0	0	0	0	3	0	0	0	0	0	0	0	0	0	0	0	0	0	0	0	0	3	0	3
08:15 AM	0	0	0	0	0	0	0	0	10	0	0	0	0	0	0	0	0	0	0	0	0	0	0	0	0	11	0	11
08:30 AM	0	0	0	0	0	0	0	0	5	0	0	0	0	0	0	0	0	0	0	0	0	0	0	0	0	5	0	5
08:45 AM	0	0	0	0	0	0	0	0	8	0	0	0	0	0	0	0	0	0	0	0	0	0	0	0	0	8	0	8
Total	0	0	0	0	0	0	0	0	26	0	0	0	0	0	0	0	0	0	0	0	0	0	0	1	0	27	0	27
Grand Total	0	0	0	1	0	0	0	0	30	0	0	0	0	0	0	0	0	0	0	0	0	0	0	1	0	32	0	32
Approch %	0	0	0			0	0	0			0	0	0			0	0	0										
Total %																										100	0	
Bicycles on Crosswalk																										0	0	0
% Bicycles on Crosswalk	0	0	0	0	0	0	0	0	0	0	0	0	0	0	0	0	0	0	0	0	0	0	0	0	0	0	0	0
Pedestrians																										0	0	32
% Pedestrians	0	0	0	100	100	0	0	0	100	100	0	0	0	0	0	0	0	0	100	100	0	0	0	100	100	0	0	100

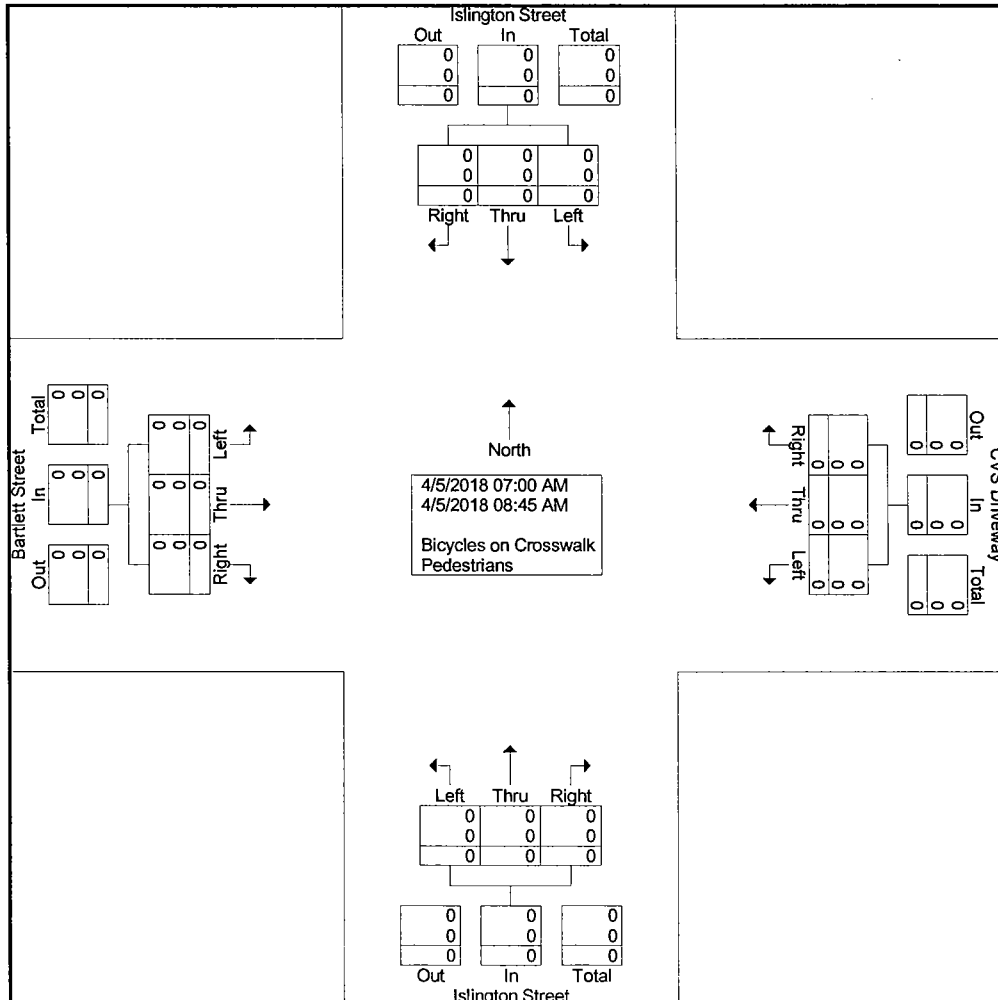

Stephen G. Pernaw & Co., Inc.
P.O. Box 1721
Concord, New Hampshire 03302

Weather: Clear
Collected By: MV
Job Number: 1821A
Town/State: Portsmouth, NH

File Name : 1821A_INT_C_PM_PH
Site Code : 1821A
Start Date : 4/5/2018
Page No : 3

Start Time	Islington Street From North					CVS Driveway From East					Islington Driveway From South					Bartlett Street From West					Int. Total
	Right	Thru	Left	Peds	App. Total	Right	Thru	Left	Peds	App. Total	Right	Thru	Left	Peds	App. Total	Right	Thru	Left	Peds	App. Total	
Peak Hour Analysis From 04:45 PM to 05:30 PM - Peak 1 of 1																					
Peak Hour for Entire Intersection Begins at 04:45 PM																					
04:45 PM	0	0	0	3	3	0	0	0	11	11	0	0	0	0	0	0	0	0	1	1	15
05:00 PM	0	0	0	4	4	0	0	0	13	13	0	0	0	0	0	0	0	0	0	0	17
05:15 PM	0	0	0	6	6	0	0	0	14	14	0	0	0	0	0	0	0	0	2	2	22
05:30 PM	0	0	0	0	0	0	0	0	11	11	0	0	0	0	0	0	0	0	0	0	11
Total Volume	0	0	0	13	13	0	0	0	49	49	0	0	0	0	0	0	0	0	3	3	65
% App. Total	0	0	0	100		0	0	0	100		0	0	0	0		0	0	0	100		
PHF	.000	.000	.000	.542	.542	.000	.000	.000	.875	.875	.000	.000	.000	.000	.000	.000	.000	.000	.375	.375	.739

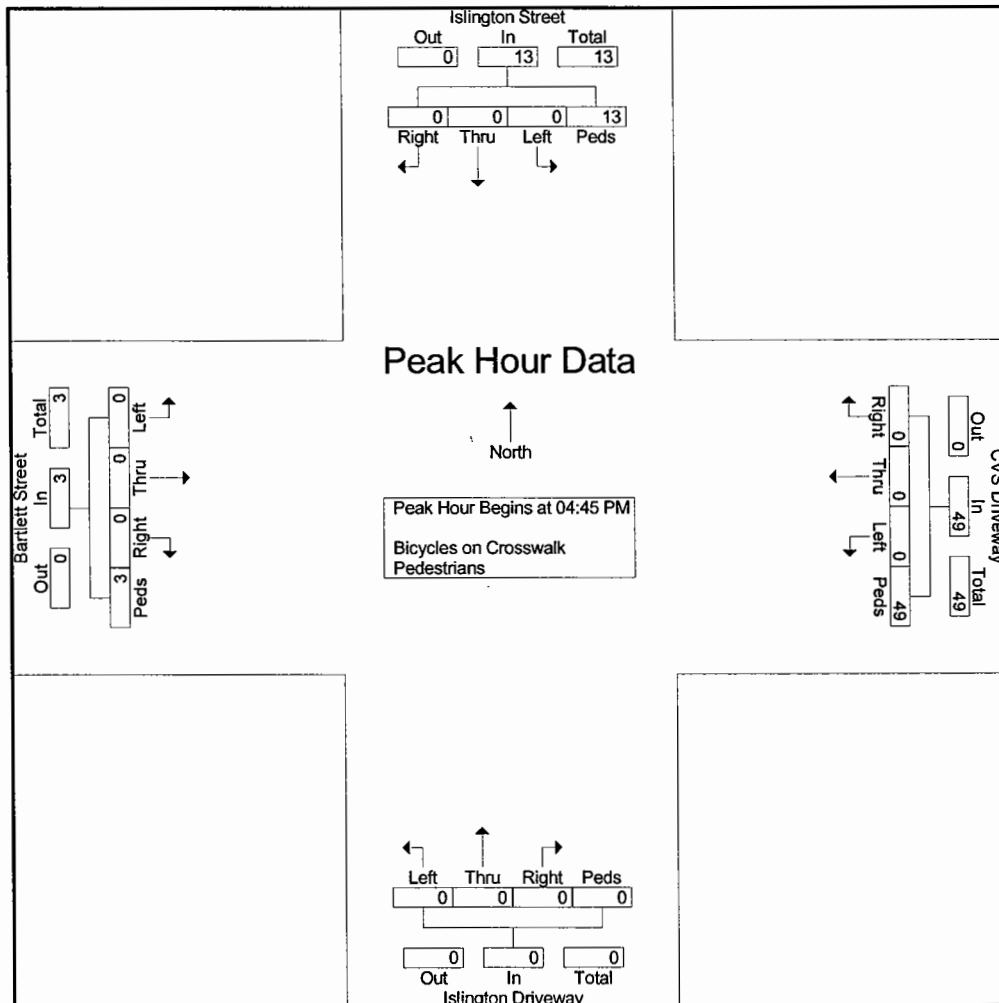

Appendix D

Seasonal Adjustment Factors / Historical Growth Rates

Seasonal Adjustment Factors NHDOT Group 4 (Urban Highways)

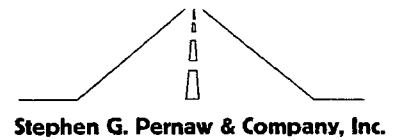

Year 2016 Monthly Data - Urban

Month	ADT	Adjustment to	
		Average	Peak
Jan	13573	1.16	1.25
Feb	14038	1.12	1.21
Mar	15731	1.00	1.08
Apr	16139	0.97	1.05
May	15705	1.00	1.08
Jun	16766	0.94	1.01
Jul	15752	1.00	1.08
Aug	16529	0.95	1.03
Sep	17007	0.92	1.00
Oct	16598	0.94	1.02
Nov	15649	1.00	1.09
Dec	14638	1.07	1.16

Year 2015 Monthly Data - Urban

Month	Data				Factors			
	AM	Mid	PM	Sat Mid	AM	Mid	PM	Sat Mid
Jan	17267	13564	20154	15524	1.11	1.14	1.11	1.17
Feb	17366	13436	20253	17441	1.10	1.16	1.11	1.05
Mar	19827	14389	22267	16671	0.97	1.08	1.01	1.09
Apr	19924	15214	22733	18484	0.96	1.02	0.99	0.99
May	20046	16198	23476	18916	0.96	0.96	0.96	0.96
Jun	19952	16451	23779	19485	0.96	0.94	0.94	0.94
Jul	18444	17126	23314	18349	1.04	0.91	0.96	0.99
Aug	18720	16672	23360	19436	1.02	0.93	0.96	0.94
Sep	20260	16000	23092	19374	0.95	0.97	0.97	0.94
Oct	20391	15823	23465	18951	0.94	0.98	0.96	0.96
Nov	19208	15635	21905	17902	1.00	0.99	1.02	1.02
Dec	18348	15787	21589	18339	1.04	0.98	1.04	0.99
Average	19146	15525	22449	18239				
Pk Factor:	1.02		1.05					

Year 2014 Monthly Data - Urban

Month	Data				Factors			
	AM	Mid	PM	Sat Mid	AM	Mid	PM	Sat Mid
Jan	21580	16848	24868	19655	1.07	1.12	1.09	1.13
Feb	21460	16679	23965	21354	1.08	1.13	1.13	1.04
Mar	23499	17228	26656	21889	0.99	1.09	1.01	1.01
Apr	24104	18688	27740	22425	0.96	1.01	0.97	0.99
May	24011	19395	28061	22720	0.96	0.97	0.96	0.98
Jun	24123	19815	28626	23204	0.96	0.95	0.94	0.96
Jul	22026	20438	27640	22602	1.05	0.92	0.98	0.98
Aug	22689	20373	28301	23080	1.02	0.93	0.95	0.96
Sep	24775	19221	28218	22917	0.93	0.98	0.96	0.97
Oct	24606	19167	28355	22965	0.94	0.98	0.95	0.97
Nov	23184	18959	25917	21967	1.00	0.99	1.04	1.01
Dec	21846	19450	25969	21696	1.06	0.97	1.04	1.02
Average	23159	18855	27026	22206				
Pk Factor:	1.03		1.03					

AVG Factor	1.03	1.04
-------------------	-------------	-------------



STEPHEN G. PERNAW & COMPANY

PROJECT: Proposed Residential Subdivision, Portsmouth, New Hampshire

NUMBER: 1821A

HISTORICAL GROWTH CALCULATIONS SUMMARY

CASE : AADT

LOCATION :

Portsmouth, NH - Bartlett St (West of Islington Street) = 1.4 % per year

Portsmouth, NH - Woodbury Ave (North of Cottage St) = -0.9 % per year

Average = 0.3 % per year

Use = 1 % per year

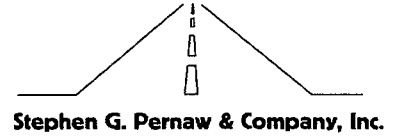

STEPHEN G. PERNAW & COMPANY, INC.
 PROJECT: Proposed Residential Subdivision, Portsmouth, New Hampshire
 NUMBER: 1821A
 COUNT STATION: 82 379052

HISTORICAL GROWTH CALCULATIONS

LOCATION : Portsmouth, NH - Bartlett St (West of Islington Street)
 CASE : AADT

ARITHMETIC PROJECTIONS

YEAR	AADT	Regression Output:		PROJECTIONS	
1998	12000	Constant	-394102.98	2017	16388
1999	13000	Std Err of Y Est	2405.5372	2018	16591
2002	17000	R Squared	0.2926427	2019	16795
2005	13000	No. of Observations	10	2020	16998
2009	12000	Degrees of Freedom	8	2021	17202
2011	11000			2022	17406
2014	17000	X Coefficient	203.51557	2023	17609
2015	17510	Std Err of Coef.	111.8673	2024	17813
2016	17860			2025	18016
2017	16414			2026	18220
				2027	18423

RATE = 204 .VPD/YEAR

GEOMETRIC PROJECTIONS

YEAR	AADT	Ln AADT	Regression Output:		PROJECTIONS	
1998	12000	9.39266	Constant	-17.82584	2017	16206
1999	13000	9.47270	Std Err of Y Est	0.1697764	2018	16428
2002	17000	9.74097	R Squared	0.271812	2019	16654
2005	13000	9.47270	No. of Observations	10	2020	16883
2009	12000	9.39266	Degrees of Freedom	8	2021	17115
2011	11000	9.30565			2022	17350
2014	17000	9.74097	X Coefficient	0.0136435	2023	17588
2015	17510	9.77053	Std Err of Coef.	0.0078953	2024	17830
2016	17860	9.79032			2025	18075
2017	16414	9.70589			2026	18323
					2027	18575

RATE = 1.4 % / YEAR



STEPHEN G. PERNAW & COMPANY, INC.

PROJECT: Proposed Residential Subdivision, Portsmouth, New Hampshire
 NUMBER: 1821A
 COUNT STATION: 82 379018

HISTORICAL GROWTH CALCULATIONS

LOCATION : Portsmouth, NH - Woodbury Ave (North of Cottage St)
 CASE : AADT

ARITHMETIC PROJECTIONS

YEAR	AADT	Regression Output:		PROJECTIONS	
2000	7300	Constant	124070.80199	2017	6047
2001	6800	Std Err of Y Est	342.5069936	2018	5989
2004	7300	R Squared	0.568824812	2019	5930
2007	6100	No. of Observations	10	2020	5872
2011	6000	Degrees of Freedom	8	2021	5813
2013	6100			2022	5755
2014	6234	X Coefficient	-58.51438053	2023	5696
2015	6421	Std Err of Coef.	18.0117219	2024	5638
2016	6154			2025	5579
2017	6277			2026	5521
				2027	5462

RATE = -59 VPD/YEAR

GEOMETRIC PROJECTIONS

YEAR	AADT	Ln AADT	Regression Output:		PROJECTIONS	
2000	7300	8.89563	Constant	26.32914	2017	6059
2001	6800	8.82468	Std Err of Y Est	0.051755249	2018	6006
2004	7300	8.89563	R Squared	0.56288323	2019	5954
2007	6100	8.71604	No. of Observations	10	2020	5902
2011	6000	8.69951	Degrees of Freedom	8	2021	5851
2013	6100	8.71604			2022	5800
2014	6234	8.73777	X Coefficient	-0.008735658	2023	5750
2015	6421	8.76733	Std Err of Coef.	0.0027217	2024	5700
2016	6154	8.72486			2025	5650
2017	6277	8.74465			2026	5601
					2027	5552

RATE = -0.9 % / YEAR

List View All DIRs

Record			1			of 1	Goto Record	<input type="text"/>	go
Location ID	82379052				MPO ID				
Type	SPOT				HPMS ID				
On NHS	No				On HPMS	Yes			
LRS ID	N3790035__				LRS Loc Pt.				
SF Group	04				Route Type				
AF Group	04				Route				
GF Group	E				Active	Yes			
Class Dist Grp	Default				Category	3			
Seas Class Grp	Default								
WIM Group	Default								
QC Group	Default								
Funct'l Class	Minor Arterial				Milepost				
Located On	Bartlett St								
Loc On Alias	BARTLETT ST WEST OF ISLINGTON ST								
	PR		MP		PT				
More Detail									
STATION DATA									

Directions: **2-WAY**

AADT

Year	AADT	DHV-30	K %	D %	PA	BC	Src
2017	16,414	1,434	9		15,233 (93%)	1,181 (7%)	
2016	17,860 ³				16,289 (91%)	1,571 (9%)	Grown from 2015
2015	17,510 ³						Grown from 2014
2014	17,000						
2011	11,000						

|<<| <| >| >>| 1-5 of 11

Travel Demand Model

Model Year	Model AADT	AM PHV	AM PPV	MD PHV	MD PPV	PM PHV	PM PPV	NT PHV	NT PPV
------------	------------	--------	--------	--------	--------	--------	--------	--------	--------

VOLUME COUNT

Date	Int	Total
Thu 9/21/2017	60	18,508
Wed 9/20/2017	60	18,359
Tue 9/19/2017	60	18,293
Fri 8/1/2014	60	18,538
Thu 7/31/2014	60	18,997
Wed 7/30/2014	60	19,331

VOLUME TREND

Year	Annual Growth
2017	-8%
2016	2%
2015	3%
2014	16%
2011	-4%
2000	2%

List View All DIRs

Record 1 of 1 Goto Record go

Location ID	82379052	MPO ID	
Type	SPOT	HPMS ID	
On NHS	No	On HPMS	Yes
LRS ID	N3790035	LRS Loc Pt.	
SF Group	04	Route Type	
AF Group	04	Route	
GF Group	E	Active	Yes
Class Dist Grp	Default	Category	3
Seas Class Grp	Default		
WIM Group	Default		
QC Group	Default		
Funct'l Class	Minor Arterial	Milepost	
Located On	Bartlett St		
Loc On Alias	BARTLETT ST WEST OF ISLINGTON ST		
	PR	MP	PT
More Detail			
STATION DATA			

Directions: **2-WAY**

AADT

Year	AADT	DHV-30	K %	D %	PA	BC	Src
2009	12,000 ²						
2005	13,000						
2002	17,000						
1999	13,000						
1998	12,000 ²						

6-10 of 11

Travel Demand Model										
Model Year	Model AADT	AM PHV	AM PPV	MD PHV	MD PPV	PM PHV	PM PPV	NT PHV	NT PPV	

VOLUME COUNT			
	Date	Int	Total
	Thu 9/21/2017	60	18,508
	Wed 9/20/2017	60	18,359
	Tue 9/19/2017	60	18,293
	Fri 8/1/2014	60	18,538
	Thu 7/31/2014	60	18,997
	Wed 7/30/2014	60	19,331
	Tue 7/29/2014	60	20,116

VOLUME TREND	
Year	Annual Growth
2017	-8%
2016	2%
2015	3%
2014	16%
2011	-4%
2009	-2%
2005	-9%

List View All DIRs

Record 1 of 1 Goto Record go

Location ID	82379018	MPO ID	
Type	SPOT	HPMS ID	
On NHS	No	On HPMS	No
LRS ID	N3790035__	LRS Loc Pt.	
SF Group	04	Route Type	
AF Group	04	Route	
GF Group	E	Active	Yes
Class Dist Grp	Default	Category	3
Seas Class Grp	Default		
WIM Group	Default		
QC Group	Default		
Funct'l Class	Minor Arterial	Milepost	
Located On	Woodbury Ave		
Loc On Alias	WOODBURY AVE NORTH OF COTTAGE ST (SB-NB) (81379190-81379191)		
	PR	MP	PT

More Detail

STATION DATA

Directions: 2-WAY NB SB

AADT

Year	AADT	DHV-30	K %	D %	PA	BC	Src
2017	6,277 ³		10	81	5,826 (93%)	451 (7%)	Grown from 2016
2016	6,154	618	10	81	5,657 (92%)	496 (8%)	
2015	6,421 ³						Grown from 2014
2014	6,234 ³						Grown from 2013
2013	6,100				5,848 (96%)	251 (4%)	

|<<| <| >| >>| 1-5 of 20

Travel Demand Model

Model Year	Model AADT	AM PHV	AM PPV	MD PHV	MD PPV	PM PHV	PM PPV	NT PHV	NT PPV
------------	------------	--------	--------	--------	--------	--------	--------	--------	--------

VOLUME COUNT

Date	Int	Total
Tue 9/13/2016	60	6,730
Mon 9/12/2016	60	6,607
Sun 9/11/2016	60	4,426
Fri 9/27/2013	60	7,089
Thu 9/26/2013	60	6,885

VOLUME TREND

Year	Annual Growth
2017	2%
2016	-4%
2015	3%
2014	2%
2013	1%

List View All DIRs

Record		1	of 1	Goto Record	<input type="text"/>	go
Location ID	82379018		MPO ID			
Type	SPOT		HPMS ID			
On NHS	No		On HPMS	No		
LRS ID	N3790035__		LRS Loc Pt.			
SF Group	04		Route Type			
AF Group	04		Route			
GF Group	E		Active	Yes		
Class Dist Grp	Default		Category	3		
Seas Class Grp	Default					
WIM Group	Default					
QC Group	Default					
Funct'l Class	Minor Arterial		Milepost			
Located On	Woodbury Ave					
Loc On Alias	WOODBURY AVE NORTH OF COTTAGE ST (SB-NB) (81379190-81379191)					
	PR	MP	PT			
More Detail						
STATION DATA						

Directions: 2-WAY NB SB

AADT

Year	AADT	DHV-30	K %	D %	PA	BC	Src
2011	6,000 ²				5,834 (97%)	165 (3%)	
2007	6,100						
2004	7,300						
2001	6,800						
2000	7,300 ²						

|<<| <| >| >>| 6-10 of 20

Travel Demand Model

Model Year	Model AADT	AM PHV	AM PPV	MD PHV	MD PPV	PM PHV	PM PPV	NT PHV	NT PPV
------------	------------	--------	--------	--------	--------	--------	--------	--------	--------

VOLUME COUNT

Date	Int	Total
Tue 9/13/2016	60	6,730
Mon 9/12/2016	60	6,607
Sun 9/11/2016	60	4,426
Fri 9/27/2013	60	7,089
Thu 9/26/2013	60	6,885
Wed 9/25/2013	60	6,761
Tue 9/24/2013	60	6,608

VOLUME TREND

Year	Annual Growth
2017	2%
2016	-4%
2015	3%
2014	2%
2013	1%
2011	0%
2007	-6%

Appendix E

Other Development Traffic Volumes

AM Peak Hour

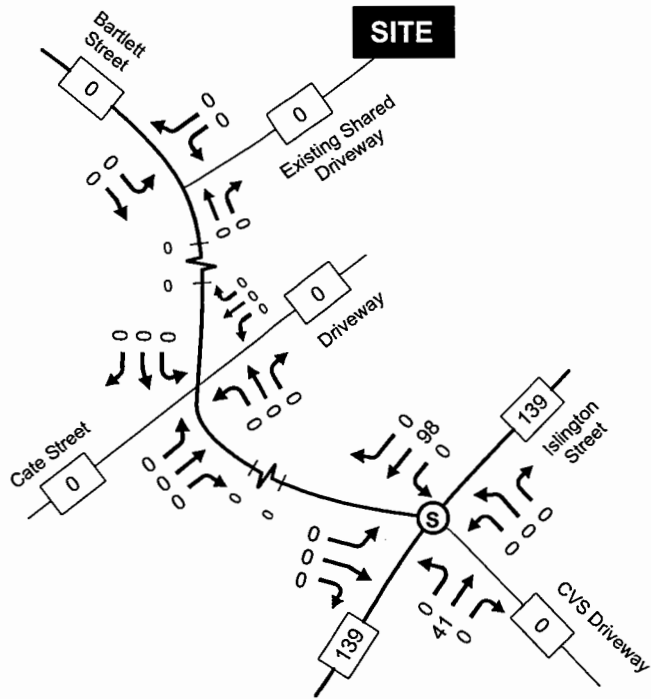

PM Peak Hour

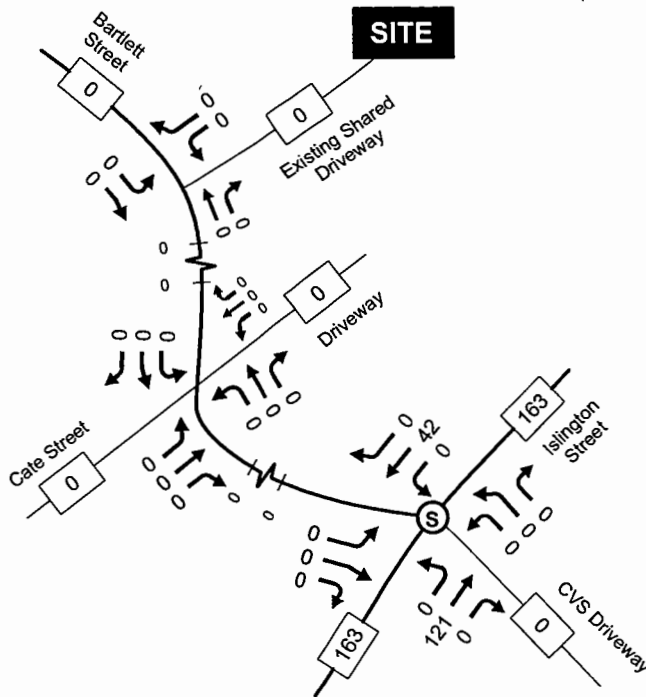

Appendix F

Site Generated Traffic Volumes / Trip Distribution

AM Peak Hour

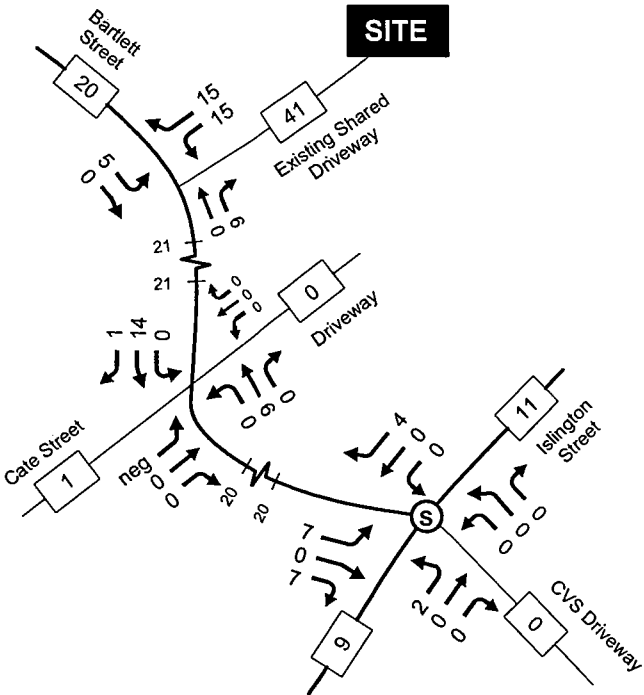

PM Peak Hour

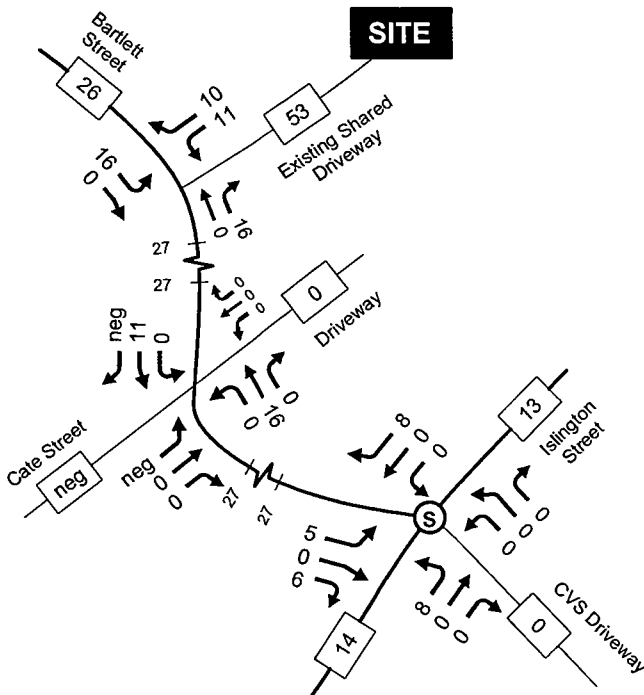

Data Plot and Equation

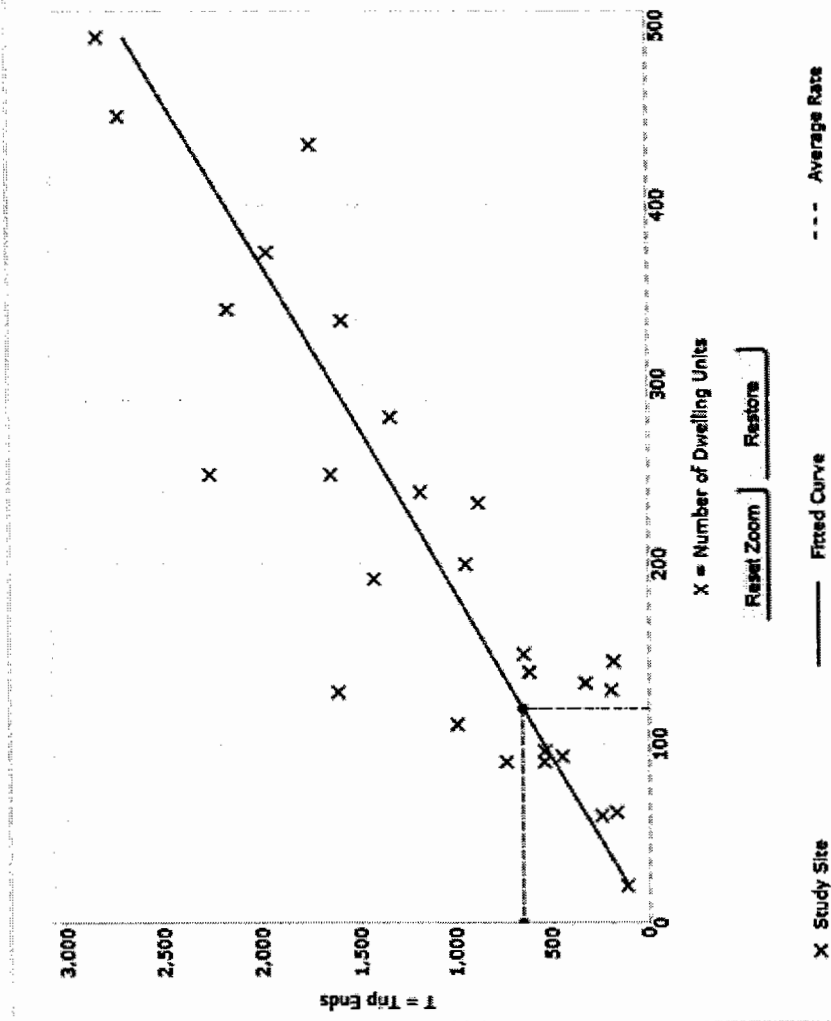

DATA STATISTICS

more details

Independent Variable:
Dwelling Units

Time Period:
Weekday

Setting/Location:
General Urban/Suburban

Trip Type:
Vehicle

Number of Studies:
27

Avg. Num. of Dwelling Units:
205

Average Rate:
5.44

Range of Rates:
1.27 - 12.50

Standard Deviation:
2.03

Fitted Curve Equation:
 $T = 5.45(X) - 1.75$

R^2 :
0.77

Directional Distribution:
50% entering, 50% exiting

Calculated Trip Ends:
Average Rate: 653 (Total)
Fitted Curve: 652 (Total)

W/ DAY

DATA SOURCE:
ITE-TGM 10th Edition

SEARCH BY LAND USE CODE:
221

LAND USE CATEGORY:
(200-299) Residential

LAND USE:
221 - Multifamily Housing (Mid-Rise)

INDEPENDENT VARIABLE (IV):
Dwelling Units

TIME PERIOD:
Weekday

SETTING/LOCATION:
General Urban/Suburban

TRIP TYPE:
Vehicle

ENTER IV VALUE TO CALCULATE TRIPS:
120

Use the mouse wheel to Zoom Out or Zoom In.
Hover the mouse pointer on data points to view X and T values.

Data Plot and Equation

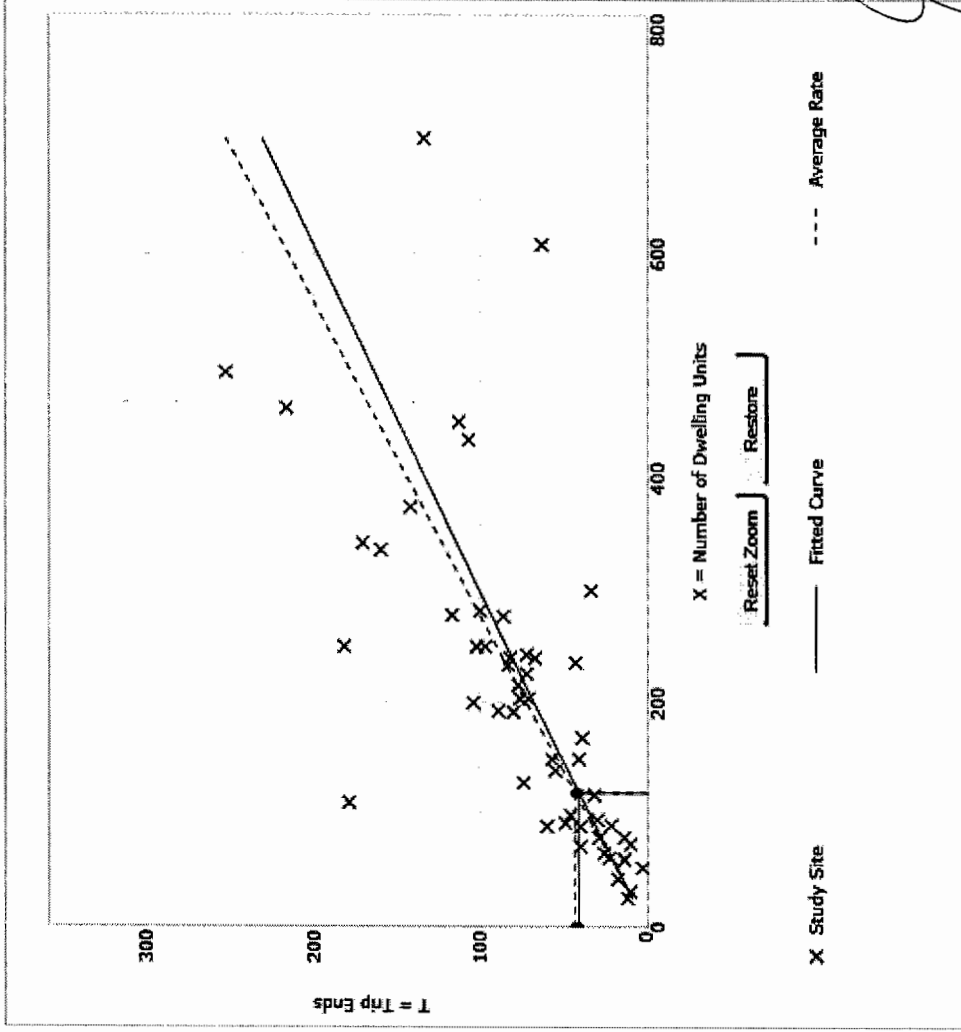

DATA STATISTICS

Dwelling Units: [Value]
 Time Period: Weekday
 Peak Hour of Adjacent Street Traffic: One Hour Between 7 and 9 a.m.
 Setting/Location: General Urban/Suburban
 Trip Type: Vehicle
 Number of Studies: 53
 Avg. Num. of Dwelling Units: 207
 Average Rate: 0.38
 Range of Rates: 0.08 - 1.81
 Standard Deviation: 0.19
 Fitted Curve Equation: $\ln(T) = 0.08 \ln(X) - 0.98$
 R^2 : 0.87
 Directional Distribution: 28% entering, 74% exiting
 Calculated Trip Ends: Average Rate: 43 (Total)
 Fitted Curve: 41 (Total)

AM PM

Query Filter

DATA SOURCE: ITE-TGM 10th Edition
 SEARCH BY LAND USE CODE: 221
 LAND USE CATEGORY: (200-299) Residential
 LAND USE: 221 - Multifamily Housing (Mid-Rise)
 INDEPENDENT VARIABLE (IV): Dwelling Units
 TIME PERIOD: Weekday, Peak Hour of Adjacent Street Traffic
 SETTING/LOCATION: General Urban/Suburban
 TRIP TYPE: Vehicle
 ENTER IV VALUE TO CALCULATE TRIPS: 120 Calculate

Use the mouse wheel to Zoom Out or Zoom In.
 Hover the mouse pointer on data points to view X and T values.

Data Plot and Equation

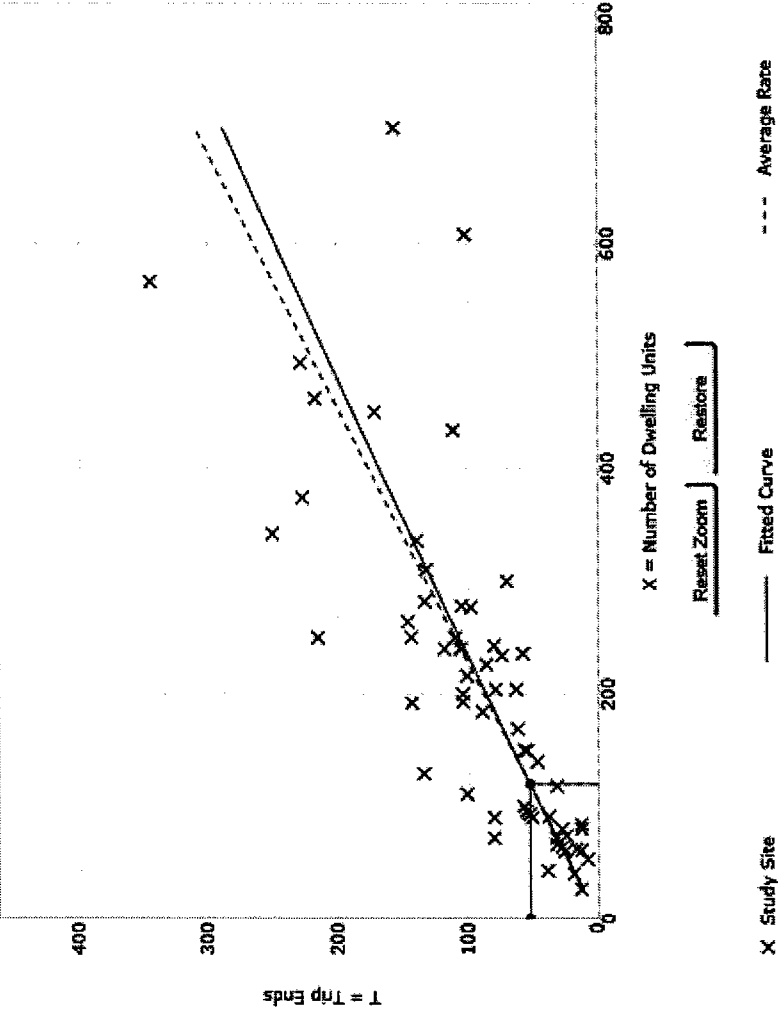

DATA STATISTICS

Dwelling Units: 208
Time Period: Weekday
Setting/Location: General Urban/Suburban
Trip Type: Vehicle
Number of Studies: 60
Avg. Num. of Dwelling Units: 208
Average Rate: 0.44
Range of Rates: 0.15 - 1.11
Standard Deviation: 0.19
Fitted Curve Equation: $\ln(T) = 0.00 \ln(X) - 0.03$
R²: 0.72
Directional Distribution: 81% entering, 35% exiting
Calculated Trip Ends: 53 (Total)
Average Rate: 53 (Total)
Fitted Curve: 53 (Total)

PNP PPT

Use the mouse wheel to Zoom Out or Zoom In.
 Hover the mouse pointer on data points to view X and T values.

Query

Filter

DATA SOURCE:

ITE-TGM 10th Edition

SEARCH BY LAND USE CODE:

221

LAND USE CATEGORY:

(200-299) Residential

LAND USE:

221 - Multifamily Housing (Mid-Rise)

INDEPENDENT VARIABLE (IV):

Dwelling Units

TIME PERIOD:

Weekday, Peak Hour of Adjacent Street Traffic

SETTING/LOCATION:

General Urban/Suburban

TRIP TYPE:

Vehicle

ENTER IV VALUE TO CALCULATE TRIPS:

120 Calculate

Appendix G

Capacity and Level of Service Calculations – Unsignalized

HCM 2010 TWSC
2: Cate Street & Bartlett Street

Intersection

Int Delay, s/veh 1.4

Movement	NBL	NBT	SBT	SBR	NEL	NER
Lane Configurations		↕	↕		↕	↕
Traffic Vol, veh/h	110	353	447	21	2	31
Future Vol, veh/h	110	353	447	21	2	31
Conflicting Peds, #/hr	0	0	0	0	0	0
Sign Control	Free	Free	Free	Free	Stop	Stop
RT Channelized	-	None	-	None	-	None
Storage Length	-	-	-	-	0	-
Veh in Median Storage, #	-	0	0	-	0	-
Grade, %	-	0	0	-	0	-
Peak Hour Factor	90	90	90	90	90	90
Heavy Vehicles, %	2	2	2	2	2	2
Mvmt Flow	122	392	497	23	2	34

Major/Minor	Major1	Major2	Minor2		
Conflicting Flow All	520	0	-	0	1145 509
Stage 1	-	-	-	-	509 -
Stage 2	-	-	-	-	636 -
Critical Hdwy	4.12	-	-	-	6.42 6.22
Critical Hdwy Stg 1	-	-	-	-	5.42 -
Critical Hdwy Stg 2	-	-	-	-	5.42 -
Follow-up Hdwy	2.218	-	-	-	3.518 3.318
Pot Cap-1 Maneuver	1046	-	-	-	221 564
Stage 1	-	-	-	-	604 -
Stage 2	-	-	-	-	527 -
Platoon blocked, %	-	-	-	-	-
Mov Cap-1 Maneuver	1046	-	-	-	188 564
Mov Cap-2 Maneuver	-	-	-	-	188 -
Stage 1	-	-	-	-	514 -
Stage 2	-	-	-	-	527 -

Approach	NB	SB	NE
HCM Control Delay, s	2.1	0	12.7
HCM LOS			B

Minor Lane/Major Mvmt	NELn1	NBL	NBT	SBT	SBR
Capacity (veh/h)	503	1046	-	-	-
HCM Lane V/C Ratio	0.073	0.117	-	-	-
HCM Control Delay (s)	12.7	8.9	0	-	-
HCM Lane LOS	B	A	A	-	-
HCM 95th %tile Q(veh)	0.2	0.4	-	-	-

HCM 2010 TWSC
2: Bartlett Street & Cate Street

Intersection

Int Delay, s/veh 1.9

Movement	EBL	EBR	NBL	NBT	SBT	SBR
Lane Configurations	Y			↑	↑	
Traffic Vol, veh/h	2 ✓	59 ✓	138 ✓	400 ✓	507 ✓	22 ✓
Future Vol, veh/h	2	59	138	400	507	22
Conflicting Peds, #/hr	0	0	0	0	0	0
Sign Control	Stop	Stop	Free	Free	Free	Free
RT Channelized	-	None	-	None	-	None
Storage Length	0	-	-	-	-	-
Veh in Median Storage, #	0	-	-	0	0	-
Grade, %	0	-	-	0	0	-
Peak Hour Factor	90	90	90	90	90	90
Heavy Vehicles, %	2	2	2	2	2	2
Mvmt Flow	2	66	153	444	563	24

Major/Minor	Minor2	Major1	Major2			
Conflicting Flow All	1325	575	587	0	-	0
Stage 1	575	-	-	-	-	-
Stage 2	750	-	-	-	-	-
Critical Hdwy	6.42	6.22	4.12	-	-	-
Critical Hdwy Stg 1	5.42	-	-	-	-	-
Critical Hdwy Stg 2	5.42	-	-	-	-	-
Follow-up Hdwy	3.518	3.318	2.218	-	-	-
Pot Cap-1 Maneuver	172	518	988	-	-	-
Stage 1	563	-	-	-	-	-
Stage 2	467	-	-	-	-	-
Platoon blocked, %				-	-	-
Mov Cap-1 Maneuver	137	518	988	-	-	-
Mov Cap-2 Maneuver	137	-	-	-	-	-
Stage 1	447	-	-	-	-	-
Stage 2	467	-	-	-	-	-

Approach	EB	NB	SB
HCM Control Delay, s	13.8	2.4	0
HCM LOS	B		

Minor Lane/Major Mvmt	NBL	NBT	EBLn1	SBT	SBR
Capacity (veh/h)	988	-	475	-	-
HCM Lane V/C Ratio	0.155	-	0.143	-	-
HCM Control Delay (s)	9.3	0	13.8	-	-
HCM Lane LOS	A	A	B	-	-
HCM 95th %tile Q(veh)	0.5	-	0.5	-	-

HCM 2010 TWSC
 2: Bartlett Street & Cate Street

Intersection

Int Delay, s/veh 2

Movement EBL EBR NBL NBT SBT SBR

Lane Configurations	Y					
Traffic Vol, veh/h	2 ✓	62 ✓	150 ✓	439 ✓	556 ✓	24 ✓
Future Vol, veh/h	2	62	150	439	556	24
Conflicting Peds, #/hr	0	0	0	0	0	0
Sign Control	Stop	Stop	Free	Free	Free	Free
RT Channelized	-	None	-	None	-	None
Storage Length	0	-	-	-	-	-
Veh in Median Storage, #	0	-	-	0	0	-
Grade, %	0	-	-	0	0	-
Peak Hour Factor	90	90	90	90	90	90
Heavy Vehicles, %	2	2	2	2	2	2
Mvmt Flow	2	69	167	488	618	27

Major/Minor Minor2 Major1 Major2

Conflicting Flow All	1454	632	645	0	-	0
Stage 1	632	-	-	-	-	-
Stage 2	822	-	-	-	-	-
Critical Hdwy	6.42	6.22	4.12	-	-	-
Critical Hdwy Stg 1	5.42	-	-	-	-	-
Critical Hdwy Stg 2	5.42	-	-	-	-	-
Follow-up Hdwy	3.518	3.318	2.218	-	-	-
Pot Cap-1 Maneuver	143	480	940	-	-	-
Stage 1	530	-	-	-	-	-
Stage 2	432	-	-	-	-	-
Platoon blocked, %				-	-	-
Mov Cap-1 Maneuver	108	480	940	-	-	-
Mov Cap-2 Maneuver	108	-	-	-	-	-
Stage 1	401	-	-	-	-	-
Stage 2	432	-	-	-	-	-

Approach EB NB SB

HCM Control Delay, s	14.9	2.5	0
HCM LOS	B		

Minor Lane/Major Mvmt NBL NBT EBLn1 SBT SBR

Capacity (veh/h)	940	-	433	-	-
HCM Lane V/C Ratio	0.177	-	0.164	-	-
HCM Control Delay (s)	9.7	0	14.9	-	-
HCM Lane LOS	A	A	B	-	-
HCM 95th %tile Q(veh)	0.6	-	0.6	-	-

HCM 2010 TWSC
2: Bartlett Street & Cate Street

Intersection

Int Delay, s/veh 1.9

Movement	EBL	EBR	NBL	NBT	SBT	SBR
Lane Configurations	Y			Y	Y	
Traffic Vol, veh/h	2 ✓	59 ✓	138 ✓	406 ✓	521 ✓	23 ✓
Future Vol, veh/h	2	59	138	406	521	23
Conflicting Peds, #/hr	0	0	0	0	0	0
Sign Control	Stop	Stop	Free	Free	Free	Free
RT Channelized	-	None	-	None	-	None
Storage Length	0	-	-	-	-	-
Veh in Median Storage, #	0	-	-	0	0	-
Grade, %	0	-	-	0	0	-
Peak Hour Factor	90	90	90	90	90	90
Heavy Vehicles, %	2	2	2	2	2	2
Mvmt Flow	2	66	153	451	579	26

Major/Minor	Minor2	Major1	Major2			
Conflicting Flow All	1349	592	605	0	-	0
Stage 1	592	-	-	-	-	-
Stage 2	757	-	-	-	-	-
Critical Hdwy	6.42	6.22	4.12	-	-	-
Critical Hdwy Stg 1	5.42	-	-	-	-	-
Critical Hdwy Stg 2	5.42	-	-	-	-	-
Follow-up Hdwy	3.518	3.318	2.218	-	-	-
Pot Cap-1 Maneuver	166	506	973	-	-	-
Stage 1	553	-	-	-	-	-
Stage 2	463	-	-	-	-	-
Platoon blocked, %				-	-	-
Mov Cap-1 Maneuver	131	506	973	-	-	-
Mov Cap-2 Maneuver	131	-	-	-	-	-
Stage 1	437	-	-	-	-	-
Stage 2	463	-	-	-	-	-

Approach	EB	NB	SB
HCM Control Delay, s	14.1	2.4	0
HCM LOS	B		

Minor Lane/Major Mvmt	NBL	NBT	EBLn1	SBT	SBR
Capacity (veh/h)	973	-	463	-	-
HCM Lane V/C Ratio	0.158	-	0.146	-	-
HCM Control Delay (s)	9.4	0	14.1	-	-
HCM Lane LOS	A	A	B	-	-
HCM 95th %tile Q(veh)	0.6	-	0.5	-	-

HCM 2010 TWSC
 2: Bartlett Street & Cate Street

Intersection

Int Delay, s/veh 2

Movement EBL EBR NBL NBT SBT SBR

Lane Configurations	Y			↑	↑	
Traffic Vol, veh/h	2 ✓	62 ✓	150 ✓	445 ✓	570 ✓	25 ✓
Future Vol, veh/h	2	62	150	445	570	25
Conflicting Peds, #/hr	0	0	0	0	0	0
Sign Control	Stop	Stop	Free	Free	Free	Free
RT Channelized	-	None	-	None	-	None
Storage Length	0	-	-	-	-	-
Veh in Median Storage, #	0	-	-	0	0	-
Grade, %	0	-	-	0	0	-
Peak Hour Factor	90	90	90	90	90	90
Heavy Vehicles, %	2	2	2	2	2	2
Mvmt Flow	2	69	167	494	633	28

Major/Minor Minor2 Major1 Major2

Conflicting Flow All	1475	647	661	0	-	0
Stage 1	647	-	-	-	-	-
Stage 2	828	-	-	-	-	-
Critical Hdwy	6.42	6.22	4.12	-	-	-
Critical Hdwy Stg 1	5.42	-	-	-	-	-
Critical Hdwy Stg 2	5.42	-	-	-	-	-
Follow-up Hdwy	3.518	3.318	2.218	-	-	-
Pot Cap-1 Maneuver	139	471	927	-	-	-
Stage 1	521	-	-	-	-	-
Stage 2	429	-	-	-	-	-
Platoon blocked, %				-	-	-
Mov Cap-1 Maneuver	105	471	927	-	-	-
Mov Cap-2 Maneuver	105	-	-	-	-	-
Stage 1	392	-	-	-	-	-
Stage 2	429	-	-	-	-	-

Approach EB NB SB

HCM Control Delay, s	15.2	2.5	0
HCM LOS	C		

Minor Lane/Major Mvmt NBL NBT EBLn1 SBT SBR

Capacity (veh/h)	927	-	425	-	-
HCM Lane V/C Ratio	0.18	-	0.167	-	-
HCM Control Delay (s)	9.7	0	15.2	-	-
HCM Lane LOS	A	A	C	-	-
HCM 95th %tile Q(veh)	0.7	-	0.6	-	-

HCM 2010 TWSC
 2: Cate Street & Bartlett Street

Intersection

Int Delay, s/veh 1.7

Movement	NBL	NBT	SBT	SBR	NEL	NER
Lane Configurations		↕	↕		↕	↕
Traffic Vol, veh/h	78	455	590	12	4	72
Future Vol, veh/h	78	455	590	12	4	72
Conflicting Peds, #/hr	0	0	0	0	0	0
Sign Control	Free	Free	Free	Free	Stop	Stop
RT Channelized	-	None	-	None	-	None
Storage Length	-	-	-	-	0	-
Veh in Median Storage, #	-	0	0	-	0	-
Grade, %	-	0	0	-	0	-
Peak Hour Factor	88	88	95	95	83	83
Heavy Vehicles, %	0	1	1	0	0	0
Mvmt Flow	89	517	621	13	5	87

Major/Minor

	Major1	Major2	Minor2		
Conflicting Flow All	634	0	-	0	1323 628
Stage 1	-	-	-	-	628 -
Stage 2	-	-	-	-	695 -
Critical Hdwy	4.1	-	-	-	6.4 6.2
Critical Hdwy Stg 1	-	-	-	-	5.4 -
Critical Hdwy Stg 2	-	-	-	-	5.4 -
Follow-up Hdwy	2.2	-	-	-	3.5 3.3
Pot Cap-1 Maneuver	959	-	-	-	174 487
Stage 1	-	-	-	-	536 -
Stage 2	-	-	-	-	499 -
Platoon blocked, %		-	-	-	
Mov Cap-1 Maneuver	959	-	-	-	151 487
Mov Cap-2 Maneuver	-	-	-	-	151 -
Stage 1	-	-	-	-	466 -
Stage 2	-	-	-	-	499 -

Approach

	NB	SB	NE
HCM Control Delay, s	1.3	0	15.4
HCM LOS			C

Minor Lane/Major Mvmt

	NELn1	NBL	NBT	SBT	SBR
Capacity (veh/h)	436	959	-	-	-
HCM Lane V/C Ratio	0.21	0.092	-	-	-
HCM Control Delay (s)	15.4	9.1	0	-	-
HCM Lane LOS	C	A	A	-	-
HCM 95th %tile Q(veh)	0.8	0.3	-	-	-

HCM 2010 TWSC
2: Cate Street & Bartlett Street

Intersection

Int Delay, s/veh 2.3

Movement NBL NBT SBT SBR NEL NER

Movement	NBL	NBT	SBT	SBR	NEL	NER
Lane Configurations		↕	↕		↕	↕
Traffic Vol, veh/h	116	532	665	14	4	102
Future Vol, veh/h	116	532	665	14	4	102
Conflicting Peds, #/hr	0	0	0	0	0	0
Sign Control	Free	Free	Free	Free	Stop	Stop
RT Channelized	-	None	-	None	-	None
Storage Length	-	-	-	-	0	-
Veh in Median Storage, #	-	0	0	-	0	-
Grade, %	-	0	0	-	0	-
Peak Hour Factor	88	88	95	95	83	83
Heavy Vehicles, %	0	1	1	0	0	0
Mvmt Flow	132	605	700	15	5	123

Major/Minor Major1 Major2 Minor2

Conflicting Flow All	715	0	-	0	1577	708
Stage 1	-	-	-	-	708	-
Stage 2	-	-	-	-	869	-
Critical Hdwy	4.1	-	-	-	6.4	6.2
Critical Hdwy Stg 1	-	-	-	-	5.4	-
Critical Hdwy Stg 2	-	-	-	-	5.4	-
Follow-up Hdwy	2.2	-	-	-	3.5	3.3
Pot Cap-1 Maneuver	895	-	-	-	122	438
Stage 1	-	-	-	-	492	-
Stage 2	-	-	-	-	414	-
Platoon blocked, %	-	-	-	-	-	-
Mov Cap-1 Maneuver	895	-	-	-	95	438
Mov Cap-2 Maneuver	-	-	-	-	95	-
Stage 1	-	-	-	-	383	-
Stage 2	-	-	-	-	414	-

Approach NB SB NE

HCM Control Delay, s	1.7	0	18.9
HCM LOS			C

Minor Lane/Major Mvmt NELn1 NBL NBT SBT SBR

Capacity (veh/h)	385	895	-	-	-
HCM Lane V/C Ratio	0.332	0.147	-	-	-
HCM Control Delay (s)	18.9	9.7	0	-	-
HCM Lane LOS	C	A	A	-	-
HCM 95th %tile Q(veh)	1.4	0.5	-	-	-

HCM 2010 TWSC
2: Cate Street & Bartlett Street

Intersection

Int Delay, s/veh 2.6

Movement NBL NBT SBT SBR NEL NER

Movement	NBL	NBT	SBT	SBR	NEL	NER
Lane Configurations		↕	↕		↕	↕
Traffic Vol, veh/h	125	583	731	15	4	110
Future Vol, veh/h	125	583	731	15	4	110
Conflicting Peds, #/hr	0	0	0	0	0	0
Sign Control	Free	Free	Free	Free	Stop	Stop
RT Channelized	-	None	-	None	-	None
Storage Length	-	-	-	-	0	-
Veh in Median Storage, #	-	0	0	-	0	-
Grade, %	-	0	0	-	0	-
Peak Hour Factor	88	88	95	95	83	83
Heavy Vehicles, %	0	1	1	0	0	0
Mvmt Flow	142	663	769	16	5	133

Major/Minor Major1 Major2 Minor2

Major/Minor	Major1	Major2	Minor2
Conflicting Flow All	785	0	0 1724 777
Stage 1	-	-	- 777 -
Stage 2	-	-	- 947 -
Critical Hdwy	4.1	-	- 6.4 6.2
Critical Hdwy Stg 1	-	-	- 5.4 -
Critical Hdwy Stg 2	-	-	- 5.4 -
Follow-up Hdwy	2.2	-	- 3.5 3.3
Pot Cap-1 Maneuver	843	-	- 99 400
Stage 1	-	-	- 457 -
Stage 2	-	-	- 380 -
Platoon blocked, %	-	-	- - -
Mov Cap-1 Maneuver	843	-	- 73 400
Mov Cap-2 Maneuver	-	-	- 73 -
Stage 1	-	-	- 335 -
Stage 2	-	-	- 380 -

Approach NB SB NE

HCM Control Delay, s 1.8 0 22.1
HCM LOS C

Minor Lane/Major Mvmt NELn1 NBL NBT SBT SBR

Minor Lane/Major Mvmt	NELn1	NBL	NBT	SBT	SBR
Capacity (veh/h)	346	843	-	-	-
HCM Lane V/C Ratio	0.397	0.168	-	-	-
HCM Control Delay (s)	22.1	10.1	0	-	-
HCM Lane LOS	C	B	A	-	-
HCM 95th %tile Q(veh)	1.8	0.6	-	-	-

HCM 2010 TWSC
 2: Cate Street & Bartlett Street

Intersection

Int Delay, s/veh 2.3

Movement	NBL	NBT	SBT	SBR	NEL	NER
Lane Configurations		↕	↕		↕	↕
Traffic Vol, veh/h	116	548	676	14	4	102
Future Vol, veh/h	116	548	676	14	4	102
Conflicting Peds, #/hr	0	0	0	0	0	0
Sign Control	Free	Free	Free	Free	Stop	Stop
RT Channelized	-	None	-	None	-	None
Storage Length	-	-	-	-	0	-
Veh in Median Storage, #	-	0	0	-	0	-
Grade, %	-	0	0	-	0	-
Peak Hour Factor	88	88	95	95	83	83
Heavy Vehicles, %	0	1	1	0	0	0
Mvmt Flow	132	623	712	15	5	123

Major/Minor	Major1	Major2	Minor2
Conflicting Flow All	727	0	1607
Stage 1	-	-	720
Stage 2	-	-	887
Critical Hdwy	4.1	-	6.4
Critical Hdwy Stg 1	-	-	5.4
Critical Hdwy Stg 2	-	-	5.4
Follow-up Hdwy	2.2	-	3.5
Pot Cap-1 Maneuver	886	-	117
Stage 1	-	-	486
Stage 2	-	-	406
Platoon blocked, %	-	-	-
Mov Cap-1 Maneuver	886	-	90
Mov Cap-2 Maneuver	-	-	90
Stage 1	-	-	375
Stage 2	-	-	406

Approach	NB	SB	NE
HCM Control Delay, s	1.7	0	19.4
HCM LOS			C

Minor Lane/Major Mvmt	NELn1	NBL	NBT	SBT	SBR
Capacity (veh/h)	377	886	-	-	-
HCM Lane V/C Ratio	0.339	0.149	-	-	-
HCM Control Delay (s)	19.4	9.8	0	-	-
HCM Lane LOS	C	A	A	-	-
HCM 95th %tile Q(veh)	1.5	0.5	-	-	-

HCM 2010 TWSC
 2: Cate Street & Bartlett Street

Intersection						
Int Delay, s/veh	2.6					
Movement	NBL	NBT	SBT	SBR	NEL	NER
Lane Configurations		↖	↗		↖	↗
Traffic Vol, veh/h	125	599	742	15	4	110
Future Vol, veh/h	125	599	742	15	4	110
Conflicting Peds, #/hr	0	0	0	0	0	0
Sign Control	Free	Free	Free	Free	Stop	Stop
RT Channelized	-	None	-	None	-	None
Storage Length	-	-	-	-	0	-
Veh in Median Storage, #	-	0	0	-	0	-
Grade, %	-	0	0	-	0	-
Peak Hour Factor	88	88	95	95	83	83
Heavy Vehicles, %	0	1	1	0	0	0
Mvmt Flow	142	681	781	16	5	133

Major/Minor	Major1	Major2	Minor2		
Conflicting Flow All	797	0	-	0	1754 789
Stage 1	-	-	-	-	789 -
Stage 2	-	-	-	-	965 -
Critical Hdwy	4.1	-	-	-	6.4 6.2
Critical Hdwy Stg 1	-	-	-	-	5.4 -
Critical Hdwy Stg 2	-	-	-	-	5.4 -
Follow-up Hdwy	2.2	-	-	-	3.5 3.3
Pot Cap-1 Maneuver	834	-	-	-	95 394
Stage 1	-	-	-	-	451 -
Stage 2	-	-	-	-	373 -
Platoon blocked, %		-	-	-	
Mov Cap-1 Maneuver	834	-	-	-	69 394
Mov Cap-2 Maneuver	-	-	-	-	69 -
Stage 1	-	-	-	-	327 -
Stage 2	-	-	-	-	373 -

Approach	NB	SB	NE
HCM Control Delay, s	1.8	0	22.8
HCM LOS			C

Minor Lane/Major Mvmt	NELn1	NBL	NBT	SBT	SBR
Capacity (veh/h)	338	834	-	-	-
HCM Lane V/C Ratio	0.406	0.17	-	-	-
HCM Control Delay (s)	22.8	10.2	0	-	-
HCM Lane LOS	C	B	A	-	-
HCM 95th %tile Q(veh)	1.9	0.6	-	-	-

HCM 2010 TWSC
 3: Bartlett Street & Shared Driveway

Intersection

Int Delay, s/veh 2.4

Movement	NBT	NBR	SBL	SBT	SWL	SWR
Lane Configurations	↖			↗	↖	↗
Traffic Vol, veh/h	316 ✓	47 ✓	48 ✓	410 ✓	38 ✓	33 ✓
Future Vol, veh/h	316	47	48	410	38	33
Conflicting Peds, #/hr	0	0	0	0	0	0
Sign Control	Free	Free	Free	Free	Stop	Stop
RT Channelized	-	None	-	None	-	None
Storage Length	-	-	-	-	0	-
Veh in Median Storage, #	0	-	-	0	0	-
Grade, %	0	-	-	0	0	-
Peak Hour Factor	81	81	88	88	68	68
Heavy Vehicles, %	3	0	6	4	3	12
Mvmt Flow	390	58	55	466	56	49

Major/Minor	Major1	Major2	Minor1	Minor2	Minor3
Conflicting Flow All	0	0	448	0	995
Stage 1	-	-	-	-	419
Stage 2	-	-	-	-	576
Critical Hdwy	-	-	4.16	-	6.43
Critical Hdwy Stg 1	-	-	-	-	5.43
Critical Hdwy Stg 2	-	-	-	-	5.43
Follow-up Hdwy	-	-	2.254	-	3.527
Pot Cap-1 Maneuver	-	-	1091	-	270
Stage 1	-	-	-	-	661
Stage 2	-	-	-	-	560
Platoon blocked, %	-	-	-	-	-
Mov Cap-1 Maneuver	-	-	1091	-	252
Mov Cap-2 Maneuver	-	-	-	-	252
Stage 1	-	-	-	-	616
Stage 2	-	-	-	-	560

Approach	NB	SB	SW
HCM Control Delay, s	0	0.9	19.8
HCM LOS			C

Minor Lane/Major Mvmt	NBT	NBR	SBL	SBT	SWL	SWR
Capacity (veh/h)	-	-	1091	-	-	347
HCM Lane V/C Ratio	-	-	0.05	-	-	0.301
HCM Control Delay (s)	-	-	8.5	0	0	19.8
HCM Lane LOS	-	-	A	A	A	C
HCM 95th %tile Q(veh)	-	-	0.2	-	-	1.2

HCM 2010 TWSC
 3: Bartlett Street & Shared Driveway

Intersection

Int Delay, s/veh 2.4

Movement	NBT	NBR	SBL	SBT	SWL	SWR
Lane Configurations						
Traffic Vol, veh/h	361 ✓	47 ✓	48 ✓	468 ✓	38 ✓	33 ✓
Future Vol, veh/h	361	47	48	468	38	33
Conflicting Peds, #/hr	0	0	0	0	0	0
Sign Control	Free	Free	Free	Free	Stop	Stop
RT Channelized	-	None	-	None	-	None
Storage Length	-	-	-	-	0	-
Veh in Median Storage, #	0	-	-	0	0	-
Grade, %	0	-	-	0	0	-
Peak Hour Factor	81	81	88	88	68	68
Heavy Vehicles, %	3	0	6	4	3	12
Mvmt Flow	446	58	55	532	56	49

Major/Minor	Major1	Major2	Minor1	Minor2	Minor3
Conflicting Flow All	0	0	504	0	1117
Stage 1	-	-	-	-	475
Stage 2	-	-	-	-	642
Critical Hdwy	-	-	4.16	-	6.43
Critical Hdwy Stg 1	-	-	-	-	5.43
Critical Hdwy Stg 2	-	-	-	-	5.43
Follow-up Hdwy	-	-	2.254	-	3.527
Pot Cap-1 Maneuver	-	-	1040	-	228
Stage 1	-	-	-	-	624
Stage 2	-	-	-	-	522
Platoon blocked, %	-	-	-	-	-
Mov Cap-1 Maneuver	-	-	1040	-	211
Mov Cap-2 Maneuver	-	-	-	-	211
Stage 1	-	-	-	-	577
Stage 2	-	-	-	-	522

Approach	NB	SB	SW
HCM Control Delay, s	0	0.8	23.5
HCM LOS			C

Minor Lane/Major Mvmt	NBT	NBR	SBL	SBT	SWLn1
Capacity (veh/h)	-	-	1040	-	298
HCM Lane V/C Ratio	-	-	0.052	-	0.35
HCM Control Delay (s)	-	-	8.7	0	23.5
HCM Lane LOS	-	-	A	A	C
HCM 95th %tile Q(veh)	-	-	0.2	-	1.5

HCM 2010 TWSC
 3: Bartlett Street & Shared Driveway

Intersection

Int Delay, s/veh 2.6

Movement NBT NBR SBL SBT SWL SWR

Movement	NBT	NBR	SBL	SBT	SWL	SWR
Lane Configurations	↑			↑	↑	↑
Traffic Vol, veh/h	396 ✓	47 ✓	48 ✓	513 ✓	38 ✓	33 ✓
Future Vol, veh/h	396	47	48	513	38	33
Conflicting Peds, #/hr	0	0	0	0	0	0
Sign Control	Free	Free	Free	Free	Stop	Stop
RT Channelized	-	None	-	None	-	None
Storage Length	-	-	-	-	0	-
Veh in Median Storage, #	0	-	-	0	0	-
Grade, %	0	-	-	0	0	-
Peak Hour Factor	81	81	88	88	68	68
Heavy Vehicles, %	3	0	6	4	3	12
Mvmt Flow	489	58	55	583	56	49

Major/Minor Major1 Major2 Minor1

Major/Minor	Major1	Major2	Minor1	Minor2	Minor3
Conflicting Flow All	0	0	547	0	1211
Stage 1	-	-	-	-	518
Stage 2	-	-	-	-	693
Critical Hdwy	-	-	4.16	-	6.43
Critical Hdwy Stg 1	-	-	-	-	5.43
Critical Hdwy Stg 2	-	-	-	-	5.43
Follow-up Hdwy	-	-	2.254	-	3.527
Pot Cap-1 Maneuver	-	-	1003	-	200
Stage 1	-	-	-	-	596
Stage 2	-	-	-	-	494
Platoon blocked, %	-	-	-	-	-
Mov Cap-1 Maneuver	-	-	1003	-	184
Mov Cap-2 Maneuver	-	-	-	-	184
Stage 1	-	-	-	-	548
Stage 2	-	-	-	-	494

Approach NB SB SW

HCM Control Delay, s	0	0.8	27.1
HCM LOS			D

Minor Lane/Major Mvmt NBT NBR SBL SBT SWL n1

Capacity (veh/h)	-	-	1003	-	265
HCM Lane V/C Ratio	-	-	0.054	-	0.394
HCM Control Delay (s)	-	-	8.8	0	27.1
HCM Lane LOS	-	-	A	A	D
HCM 95th %tile Q(veh)	-	-	0.2	-	1.8

HCM 2010 TWSC
 3: Bartlett Street & Shared Driveway

Intersection

Int Delay, s/veh 3.9

Movement	NBT	NBR	SBL	SBT	SWL	SWR
Lane Configurations	↔	↔	↔	↔	↔	↔
Traffic Vol, veh/h	361	53	53	468	53	48
Future Vol, veh/h	361	53	53	468	53	48
Conflicting Peds, #/hr	0	0	0	0	0	0
Sign Control	Free	Free	Free	Free	Stop	Stop
RT Channelized	-	None	-	None	-	None
Storage Length	-	-	-	-	0	-
Veh in Median Storage, #	0	-	-	0	0	-
Grade, %	0	-	-	0	0	-
Peak Hour Factor	81	81	88	88	68	68
Heavy Vehicles, %	3	0	6	4	3	12
Mvmt Flow	446	65	60	532	78	71

Major/Minor	Major1	Major2	Minor1	Minor2	Minor3
Conflicting Flow All	0	0	511	0	1131 479
Stage 1	-	-	-	-	479 -
Stage 2	-	-	-	-	652 -
Critical Hdwy	-	-	4.16	-	6.43 6.32
Critical Hdwy Stg 1	-	-	-	-	5.43 -
Critical Hdwy Stg 2	-	-	-	-	5.43 -
Follow-up Hdwy	-	-	2.254	-	3.527 3.408
Pot Cap-1 Maneuver	-	-	1034	-	224 567
Stage 1	-	-	-	-	621 -
Stage 2	-	-	-	-	517 -
Platoon blocked, %	-	-	-	-	-
Mov Cap-1 Maneuver	-	-	1034	-	206 567
Mov Cap-2 Maneuver	-	-	-	-	206 -
Stage 1	-	-	-	-	570 -
Stage 2	-	-	-	-	517 -

Approach	NB	SB	SW
HCM Control Delay, s	0	0.9	29
HCM LOS			D

Minor Lane/Major Mvmt	NBT	NBR	SBL	SBT	SWLn1
Capacity (veh/h)	-	-	1034	-	295
HCM Lane V/C Ratio	-	-	0.058	-	0.503
HCM Control Delay (s)	-	-	8.7	0	29
HCM Lane LOS	-	-	A	A	D
HCM 95th %tile Q(veh)	-	-	0.2	-	2.7

HCM 2010 TWSC
 3: Bartlett Street & Shared Driveway

Intersection

Int Delay, s/veh 4.3

Movement

	NBT	NBR	SBL	SBT	SWL	SWR
Lane Configurations	↔	↔	↔	↔	↔	↔
Traffic Vol, veh/h	396	53	53	513	53	48
Future Vol, veh/h	396	53	53	513	53	48
Conflicting Peds, #/hr	0	0	0	0	0	0
Sign Control	Free	Free	Free	Free	Stop	Stop
RT Channelized	-	None	-	None	-	None
Storage Length	-	-	-	-	0	-
Veh in Median Storage, #	0	-	-	0	0	-
Grade, %	0	-	-	0	0	-
Peak Hour Factor	81	81	88	88	68	68
Heavy Vehicles, %	3	0	6	4	3	12
Mvmt Flow	489	65	60	583	78	71

Major/Minor

	Major1	Major2	Minor1	Minor2
Conflicting Flow All	0	0	554	0
Stage 1	-	-	-	522
Stage 2	-	-	-	703
Critical Hdwy	-	4.16	-	6.43
Critical Hdwy Stg 1	-	-	-	5.43
Critical Hdwy Stg 2	-	-	-	5.43
Follow-up Hdwy	-	2.254	-	3.527
Pot Cap-1 Maneuver	-	996	-	197
Stage 1	-	-	-	593
Stage 2	-	-	-	489
Platoon blocked, %	-	-	-	-
Mov Cap-1 Maneuver	-	996	-	179
Mov Cap-2 Maneuver	-	-	-	179
Stage 1	-	-	-	540
Stage 2	-	-	-	489

Approach

	NB	SB	SW
HCM Control Delay, s	0	0.8	35.3
HCM LOS			E

Minor Lane/Major Mvmt

	NBT	NBR	SBL	SBT	SWLn1
Capacity (veh/h)	-	-	996	-	262
HCM Lane V/C Ratio	-	-	0.06	-	0.567
HCM Control Delay (s)	-	-	8.8	0	35.3
HCM Lane LOS	-	-	A	A	E
HCM 95th %tile Q(veh)	-	-	0.2	-	3.2

HCM 2010 TWSC
 3: Bartlett Street & Shared Driveway

Intersection

Int Delay, s/veh 1.6

Movement NBT NBR SBL SBT SWL SWR

Lane Configurations	↕			↕	↕	
Traffic Vol, veh/h	429 ✓	28 ✓	24 ✓	580 ✓	20 ✓	48 ✓
Future Vol, veh/h	429	28	24	580	20	48
Conflicting Peds, #/hr	0	0	0	0	0	0
Sign Control	Free	Free	Free	Free	Stop	Stop
RT Channelized	-	None	-	None	-	None
Storage Length	-	-	-	-	0	-
Veh in Median Storage, #	0	-	-	0	0	-
Grade, %	0	-	-	0	0	-
Peak Hour Factor	93	93	92	92	65	65
Heavy Vehicles, %	1	0	0	1	0	0
Mvmt Flow	461	30	26	630	31	74

Major/Minor Major1 Major2 Minor1

Conflicting Flow All	0	0	491	0	1158	476
Stage 1	-	-	-	-	476	-
Stage 2	-	-	-	-	682	-
Critical Hdwy	-	-	4.1	-	6.4	6.2
Critical Hdwy Stg 1	-	-	-	-	5.4	-
Critical Hdwy Stg 2	-	-	-	-	5.4	-
Follow-up Hdwy	-	-	2.2	-	3.5	3.3
Pot Cap-1 Maneuver	-	-	1083	-	219	593
Stage 1	-	-	-	-	629	-
Stage 2	-	-	-	-	506	-
Platoon blocked, %	-	-	-	-	-	-
Mov Cap-1 Maneuver	-	-	1083	-	211	593
Mov Cap-2 Maneuver	-	-	-	-	211	-
Stage 1	-	-	-	-	606	-
Stage 2	-	-	-	-	506	-

Approach NB SB SW

HCM Control Delay, s 0 0.3 17.7
 HCM LOS C

Minor Lane/Major Mvmt NBT NBR SBL SBT SWLn1

Capacity (veh/h)	-	-	1083	-	387
HCM Lane V/C Ratio	-	-	0.024	-	0.27
HCM Control Delay (s)	-	-	8.4	0	17.7
HCM Lane LOS	-	-	A	A	C
HCM 95th %tile Q(veh)	-	-	0.1	-	1.1

HCM 2010 TWSC
 3: Bartlett Street & Shared Driveway

Intersection

Int Delay, s/veh 1.7

Movement NBT NBR SBL SBT SWL SWR

Lane Configurations	↕			↕	↕	
Traffic Vol, veh/h	504 ✓	28 ✓	24 ✓	655 ✓	20 ✓	48 ✓
Future Vol, veh/h	504	28	24	655	20	48
Conflicting Peds, #/hr	0	0	0	0	0	0
Sign Control	Free	Free	Free	Free	Stop	Stop
RT Channelized	-	None	-	None	-	None
Storage Length	-	-	-	-	0	-
Veh in Median Storage, #	0	-	-	0	0	-
Grade, %	0	-	-	0	0	-
Peak Hour Factor	93	93	92	92	65	65
Heavy Vehicles, %	1	0	0	1	0	0
Mvmt Flow	542	30	26	712	31	74

Major/Minor Major1 Major2 Minor1

Conflicting Flow All	0	0	572	0	1321	557
Stage 1	-	-	-	-	557	-
Stage 2	-	-	-	-	764	-
Critical Hdwy	-	-	4.1	-	6.4	6.2
Critical Hdwy Stg 1	-	-	-	-	5.4	-
Critical Hdwy Stg 2	-	-	-	-	5.4	-
Follow-up Hdwy	-	-	2.2	-	3.5	3.3
Pot Cap-1 Maneuver	-	-	1011	-	174	534
Stage 1	-	-	-	-	578	-
Stage 2	-	-	-	-	463	-
Platoon blocked, %	-	-	-	-	-	-
Mov Cap-1 Maneuver	-	-	1011	-	167	534
Mov Cap-2 Maneuver	-	-	-	-	167	-
Stage 1	-	-	-	-	553	-
Stage 2	-	-	-	-	463	-

Approach NB SB SW

HCM Control Delay, s	0	0.3	21.3
HCM LOS			C

Minor Lane/Major Mvmt NBT NBR SBL SBT SWLn1

Capacity (veh/h)	-	-	1011	-	324
HCM Lane V/C Ratio	-	-	0.026	-	0.323
HCM Control Delay (s)	-	-	8.7	0	21.3
HCM Lane LOS	-	-	A	A	C
HCM 95th %tile Q(veh)	-	-	0.1	-	1.4

HCM 2010 TWSC
3: Bartlett Street & Shared Driveway

Intersection

Int Delay, s/veh 1.9

Movement	NBT	NBR	SBL	SBT	SWL	SWR
Lane Configurations	↔			↔	↔	↔
Traffic Vol, veh/h	552 ✓	28 ✓	24 ✓	720 ✓	20 ✓	48 ✓
Future Vol, veh/h	552	28	24	720	20	48
Conflicting Peds, #/hr	0	0	0	0	0	0
Sign Control	Free	Free	Free	Free	Stop	Stop
RT Channelized	-	None	-	None	-	None
Storage Length	-	-	-	-	0	-
Veh in Median Storage, #	0	-	-	0	0	-
Grade, %	0	-	-	0	0	-
Peak Hour Factor	93	93	92	92	65	65
Heavy Vehicles, %	1	0	0	1	0	0
Mvmt Flow	594	30	26	783	31	74

Major/Minor	Major1	Major2	Minor1	Minor2	Minor3
Conflicting Flow All	0	0	624	0	1444 609
Stage 1	-	-	-	-	609 -
Stage 2	-	-	-	-	835 -
Critical Hdwy	-	-	4.1	-	6.4 6.2
Critical Hdwy Stg 1	-	-	-	-	5.4 -
Critical Hdwy Stg 2	-	-	-	-	5.4 -
Follow-up Hdwy	-	-	2.2	-	3.5 3.3
Pot Cap-1 Maneuver	-	-	967	-	147 499
Stage 1	-	-	-	-	547 -
Stage 2	-	-	-	-	429 -
Platoon blocked, %	-	-	-	-	-
Mov Cap-1 Maneuver	-	-	967	-	140 499
Mov Cap-2 Maneuver	-	-	-	-	140 -
Stage 1	-	-	-	-	521 -
Stage 2	-	-	-	-	429 -

Approach	NB	SB	SW
HCM Control Delay, s	0	0.3	24.9
HCM LOS			C

Minor Lane/Major Mvmt	NBT	NBR	SBL	SBT	SWLn1
Capacity (veh/h)	-	-	967	-	284
HCM Lane V/C Ratio	-	-	0.027	-	0.368
HCM Control Delay (s)	-	-	8.8	0	24.9
HCM Lane LOS	-	-	A	A	C
HCM 95th %tile Q(veh)	-	-	0.1	-	1.6

HCM 2010 TWSC
 3: Bartlett Street & Shared Driveway

Intersection

Int Delay, s/veh 2.9

Movement	NBT	NBR	SBL	SBT	SWL	SWR
Lane Configurations	↔	↔	↔	↔	↔	↔
Traffic Vol, veh/h	504	44	40	655	31	58
Future Vol, veh/h	504	44	40	655	31	58
Conflicting Peds, #/hr	0	0	0	0	0	0
Sign Control	Free	Free	Free	Free	Stop	Stop
RT Channelized	-	None	-	None	-	None
Storage Length	-	-	-	-	0	-
Veh in Median Storage, #	0	-	-	0	0	-
Grade, %	0	-	-	0	0	-
Peak Hour Factor	93	93	92	92	65	65
Heavy Vehicles, %	1	0	0	1	0	0
Mvmt Flow	542	47	43	712	48	89

Major/Minor	Major1	Major2	Minor1	Minor2	Minor3
Conflicting Flow All	0	0	589	0	1364 566
Stage 1	-	-	-	-	566 -
Stage 2	-	-	-	-	798 -
Critical Hdwy	-	-	4.1	-	6.4 6.2
Critical Hdwy Stg 1	-	-	-	-	5.4 -
Critical Hdwy Stg 2	-	-	-	-	5.4 -
Follow-up Hdwy	-	-	2.2	-	3.5 3.3
Pot Cap-1 Maneuver	-	-	996	-	164 528
Stage 1	-	-	-	-	572 -
Stage 2	-	-	-	-	447 -
Platoon blocked, %	-	-	-	-	-
Mov Cap-1 Maneuver	-	-	996	-	152 528
Mov Cap-2 Maneuver	-	-	-	-	152 -
Stage 1	-	-	-	-	531 -
Stage 2	-	-	-	-	447 -

Approach	NB	SB	SW
HCM Control Delay, s	0	0.5	28.9
HCM LOS			D

Minor Lane/Major Mvmt	NBT	NBR	SBL	SBT	SWLn1
Capacity (veh/h)	-	-	996	-	284
HCM Lane V/C Ratio	-	-	0.044	-	0.482
HCM Control Delay (s)	-	-	8.8	0	28.9
HCM Lane LOS	-	-	A	A	D
HCM 95th %tile Q(veh)	-	-	0.1	-	2.5

HCM 2010 TWSC
 3: Bartlett Street & Shared Driveway

Intersection

Int Delay, s/veh 3.4

Movement NBT NBR SBL SBT SWL SWR

Lane Configurations	↔	↔	↔	↔	↔	↔
Traffic Vol, veh/h	552	44	40	720	31	58
Future Vol, veh/h	552	44	40	720	31	58
Conflicting Peds, #/hr	0	0	0	0	0	0
Sign Control	Free	Free	Free	Free	Stop	Stop
RT Channelized	-	None	-	None	-	None
Storage Length	-	-	-	-	0	-
Veh in Median Storage, #	0	-	-	0	0	-
Grade, %	0	-	-	0	0	-
Peak Hour Factor	93	93	92	92	65	65
Heavy Vehicles, %	1	0	0	1	0	0
Mvmt Flow	594	47	43	783	48	89

Major/Minor Major1 Major2 Minor1

Conflicting Flow All	0	0	641	0	1487	618
Stage 1	-	-	-	-	618	-
Stage 2	-	-	-	-	869	-
Critical Hdwy	-	-	4.1	-	6.4	6.2
Critical Hdwy Stg 1	-	-	-	-	5.4	-
Critical Hdwy Stg 2	-	-	-	-	5.4	-
Follow-up Hdwy	-	-	2.2	-	3.5	3.3
Pot Cap-1 Maneuver	-	-	953	-	138	493
Stage 1	-	-	-	-	542	-
Stage 2	-	-	-	-	414	-
Platoon blocked, %	-	-	-	-	-	-
Mov Cap-1 Maneuver	-	-	953	-	127	493
Mov Cap-2 Maneuver	-	-	-	-	127	-
Stage 1	-	-	-	-	499	-
Stage 2	-	-	-	-	414	-

Approach NB SB SW

HCM Control Delay, s	0	0.5	36.6
HCM LOS			E

Minor Lane/Major Mvmt NBT NBR SBL SBT SWLn1

Capacity (veh/h)	-	-	953	-	246
HCM Lane V/C Ratio	-	-	0.046	-	0.557
HCM Control Delay (s)	-	-	9	0	36.6
HCM Lane LOS	-	-	A	A	E
HCM 95th %tile Q(veh)	-	-	0.1	-	3.1

Appendix H

Capacity and Level of Service Calculations - Signalized

HCM Signalized Intersection Capacity Analysis

1: Islington Street & Bartlett Street/Pharmacy Driveway



Movement	EBL	EBT	EBR	WBL	WBT	WBR	NBL	NBT	NBR	SBL	SBT	SBR
Lane Configurations		↕	↗		↕		↖	↕			↕	↗
Traffic Volume (vph)	206 ✓	20 ✓	212 ✓	2 ✓	10 ✓	2 ✓	132 ✓	199 ✓	10 ✓	7 ✓	193 ✓	334 ✓
Future Volume (vph)	206	20	212	2	10	2	132	199	10	7	193	334
Ideal Flow (vphpl)	1900	1900	1900	1900	1900	1900	1900	1900	1900	1900	1900	1900
Total Lost time (s)		4.0	6.0		4.0		4.0	4.0			4.0	6.0
Lane Util. Factor		1.00	1.00		1.00		1.00	1.00			1.00	1.00
Frt		1.00	0.85		0.98		1.00	0.99			1.00	0.85
Flt Protected		0.96	1.00		0.99		0.95	1.00			1.00	1.00
Satd. Flow (prot)		1769	1553		1727		1703	1801			1817	1615
Flt Permitted		0.73	1.00		0.95		0.95	1.00			0.98	1.00
Satd. Flow (perm)		1358	1553		1658		1703	1801			1790	1615
Peak-hour factor, PHF	0.91	0.91	0.91	0.88	0.88	0.88	0.87	0.87	0.87	0.89	0.89	0.89
Adj. Flow (vph)	226	22	233	2	11	2	152	229	11	8	217	375
RTOR Reduction (vph)	0	0	179	0	1	0	0	2	0	0	0	298
Lane Group Flow (vph)	0	248	54	0	14	0	152	238	0	0	225	77
Heavy Vehicles (%)	2%	10%	4%	0%	10%	0%	6%	5%	0%	14%	4%	0%
Turn Type	custom	NA	custom	custom	NA		Prot	NA		custom	NA	custom
Protected Phases							5	2				
Permitted Phases	4	4	4	8	8			2		6	6	6
Actuated Green, G (s)		12.7	12.7		12.7		7.2	24.5			11.3	11.3
Effective Green, g (s)		14.7	12.7		14.7		9.2	26.5			13.3	11.3
Actuated g/C Ratio		0.27	0.23		0.27		0.17	0.48			0.24	0.21
Clearance Time (s)		6.0	6.0		6.0		6.0	6.0			6.0	6.0
Vehicle Extension (s)		3.0	3.0		3.0		3.0	3.0			3.0	3.0
Lane Grp Cap (vph)		363	359		443		285	869			433	332
v/s Ratio Prot							c0.09	0.13				
v/s Ratio Perm		c0.18	0.03		0.01						c0.13	0.05
v/c Ratio		0.68	0.15		0.03		0.53	0.27			0.52	0.23
Uniform Delay, d1		18.0	16.8		14.8		20.9	8.5			18.0	18.2
Progression Factor		1.00	1.00		1.00		1.00	1.00			1.00	1.00
Incremental Delay, d2		5.2	0.2		0.0		1.9	0.2			1.1	0.4
Delay (s)		23.3	17.0		14.9		22.8	8.6			19.1	18.5
Level of Service		C	B		B		C	A			B	B
Approach Delay (s)		20.2			14.9			14.1			18.7	
Approach LOS		C			B			B			B	

Intersection Summary

HCM 2000 Control Delay	18.0	HCM 2000 Level of Service	B
HCM 2000 Volume to Capacity ratio	0.61		
Actuated Cycle Length (s)	54.9	Sum of lost time (s)	19.0
Intersection Capacity Utilization	50.8%	ICU Level of Service	A
Analysis Period (min)	15		
c Critical Lane Group			

Timings

1: Islington Street & Bartlett Street/Pharmacy Driveway

												Ø9
Lane Group	EBL	EBT	EBR	WBL	WBT	NBL	NBT	SBL	SBT	SBR		
Lane Configurations												
Traffic Volume (vph)	206 ✓	20 ✓	212 ✓	2 ✓	10 ✓	132	199	7 ✓	193 ✓	334 ✓		
Future Volume (vph)	206	20	212	2	10	132	199	7	193	334		
Turn Type	custom	NA	custom	custom	NA	Prot	NA	custom	NA	custom		
Protected Phases						5	2					9
Permitted Phases	4	4	4	8	8		2	6	6	6		
Detector Phase	4	4	4	8	8	5	2	6	6	6		
Switch Phase												
Minimum Initial (s)	5.0	5.0	5.0	5.0	5.0	5.0	10.0	10.0	10.0	10.0		7.0
Minimum Split (s)	11.0	11.0	11.0	11.0	11.0	16.0	16.0	16.0	16.0	16.0		24.0
Total Split (s)	18.0	18.0	18.0	18.0	18.0	16.0	33.0	17.0	17.0	17.0		24.0
Total Split (%)	24.0%	24.0%	24.0%	24.0%	24.0%	21.3%	44.0%	22.7%	22.7%	22.7%		32%
Yellow Time (s)	4.0	4.0	4.0	4.0	4.0	4.0	4.0	4.0	4.0	4.0		3.0
All-Red Time (s)	2.0	2.0	2.0	2.0	2.0	2.0	2.0	2.0	2.0	2.0		0.0
Lost Time Adjust (s)		-2.0	0.0		-2.0	-2.0	-2.0		-2.0	0.0		
Total Lost Time (s)		4.0	6.0		4.0	4.0	4.0		4.0	6.0		
Lead/Lag						Lag		Lead	Lead	Lead		
Lead-Lag Optimize?												
Recall Mode	None	None	None	None	None	None	Min	Min	Min	Min		None
Act Effect Green (s)		14.8	12.7		14.8	11.3	25.1		13.4	11.2		
Actuated g/C Ratio		0.29	0.25		0.29	0.22	0.49		0.26	0.22		
v/c Ratio		0.63	0.42		0.03	0.41	0.27		0.48	0.58		
Control Delay		31.1	6.7		18.2	24.8	10.0		25.2	7.5		
Queue Delay		0.0	0.0		0.0	0.0	0.0		0.0	0.0		
Total Delay		31.1	6.7		18.2	24.8	10.0		25.2	7.5		
LOS		C	A		B	C	A		C	A		
Approach Delay		19.3			18.2		15.7		14.1			
Approach LOS		B			B		B		B			

Intersection Summary

Cycle Length: 75
 Actuated Cycle Length: 51.5
 Natural Cycle: 75
 Control Type: Actuated-Uncoordinated
 Maximum v/c Ratio: 0.63
 Intersection Signal Delay: 16.3
 Intersection Capacity Utilization 50.8%
 Analysis Period (min) 15

Intersection LOS: B
 ICU Level of Service A

Splits and Phases: 1: Islington Street & Bartlett Street/Pharmacy Driveway

Ø2	Ø4	Ø9			
33 s	18 s	24 s			
Ø6	Ø5	Ø8			
17 s	16 s	18 s			

Queues

1: Islington Street & Bartlett Street/Pharmacy Driveway



Lane Group	EBT	EBR	WBT	NBL	NBT	SBT	SBR
Lane Group Flow (vph)	248	233	15	152	240	225	375
v/c Ratio	0.63	0.42	0.03	0.41	0.27	0.48	0.58
Control Delay	31.1	6.7	18.2	24.8	10.0	25.2	7.5
Queue Delay	0.0	0.0	0.0	0.0	0.0	0.0	0.0
Total Delay	31.1	6.7	18.2	24.8	10.0	25.2	7.5
Queue Length 50th (ft)	65	0	3	38	30	57	0
Queue Length 95th (ft)	#246	56	19	115	119	#187	69
Internal Link Dist (ft)	144		182		325	372	
Turn Bay Length (ft)		125		150			
Base Capacity (vph)	391	558	479	420	1076	478	655
Starvation Cap Reductn	0	0	0	0	0	0	0
Spillback Cap Reductn	0	0	0	0	0	0	0
Storage Cap Reductn	0	0	0	0	0	0	0
Reduced v/c Ratio	0.63	0.42	0.03	0.36	0.22	0.47	0.57

Intersection Summary

95th percentile volume exceeds capacity, queue may be longer.
 Queue shown is maximum after two cycles.

HCM Signalized Intersection Capacity Analysis

1: Islington Street & Bartlett Street/Pharmacy Driveway



Movement	EBL	EBT	EBR	WBL	WBT	WBR	NBL	NBT	NBR	SBL	SBT	SBR
Lane Configurations		↕	↗		↕		↖	↕			↕	↗
Traffic Volume (vph)	218 ✓	40 ✓	265 ✓	8 ✓	23 ✓	10 ✓	177 ✓	249 ✓	25 ✓	23 ✓	274 ✓	352 ✓
Future Volume (vph)	218	40	265	8	23	10	177	249	25	23	274	352
Ideal Flow (vphpl)	1900	1900	1900	1900	1900	1900	1900	1900	1900	1900	1900	1900
Total Lost time (s)		4.0	6.0		4.0		4.0	4.0			4.0	6.0
Lane Util. Factor		1.00	1.00		1.00		1.00	1.00			1.00	1.00
Fr _t		1.00	0.85		0.97		1.00	0.99			1.00	0.85
Fit Protected		0.96	1.00		0.99		0.95	1.00			1.00	1.00
Satd. Flow (prot)		1766	1553		1723		1703	1792			1806	1615
Fit Permitted		0.73	1.00		0.92		0.95	1.00			0.95	1.00
Satd. Flow (perm)		1338	1553		1610		1703	1792			1731	1615
Peak-hour factor, PHF	0.91	0.91	0.91	0.88	0.88	0.88	0.87	0.87	0.87	0.89	0.89	0.89
Adj. Flow (vph)	240	44	291	9	26	11	203	286	29	26	308	396
RTOR Reduction (vph)	0	0	216	0	8	0	0	3	0	0	0	295
Lane Group Flow (vph)	0	284	75	0	38	0	203	312	0	0	334	101
Heavy Vehicles (%)	2%	10%	4%	0%	10%	0%	6%	5%	0%	14%	4%	0%
Turn Type	custom	NA	custom	custom	NA		Prot	NA		custom	NA	custom
Protected Phases							5	2				
Permitted Phases	4	4	4	8	8			2		6	6	6
Actuated Green, G (s)		17.7	17.7		17.7		9.4	32.9			17.5	17.5
Effective Green, g (s)		19.7	17.7		19.7		11.4	34.9			19.5	17.5
Actuated g/C Ratio		0.29	0.26		0.29		0.17	0.51			0.28	0.26
Clearance Time (s)		6.0	6.0		6.0		6.0	6.0			6.0	6.0
Vehicle Extension (s)		3.0	3.0		3.0		3.0	3.0			3.0	3.0
Lane Grp Cap (vph)		384	401		463		283	913			492	412
v/s Ratio Prot							c0.12	0.17				
v/s Ratio Perm		c0.21	0.05		0.02						c0.19	0.06
v/c Ratio		0.74	0.19		0.08		0.72	0.34			0.68	0.25
Uniform Delay, d1		22.1	19.8		17.8		27.0	10.0			21.7	20.3
Progression Factor		1.00	1.00		1.00		1.00	1.00			1.00	1.00
Incremental Delay, d2		7.3	0.2		0.1		8.4	0.2			3.7	0.3
Delay (s)		29.4	20.0		17.9		35.4	10.2			25.4	20.6
Level of Service		C	C		B		D	B			C	C
Approach Delay (s)		24.6			17.9			20.1			22.8	
Approach LOS		C			B			C			C	

Intersection Summary

HCM 2000 Control Delay	22.5	HCM 2000 Level of Service	C
HCM 2000 Volume to Capacity ratio	0.73		
Actuated Cycle Length (s)	68.5	Sum of lost time (s)	19.0
Intersection Capacity Utilization	61.2%	ICU Level of Service	B
Analysis Period (min)	15		
c Critical Lane Group			

Timings

1: Islington Street & Bartlett Street/Pharmacy Driveway

											Ø9
Lane Group	EBL	EBT	EBR	WBL	WBT	NBL	NBT	SBL	SBT	SBR	Ø9
Lane Configurations											
Traffic Volume (vph)	218	40	265	8	23	177	249	23	274	352	
Future Volume (vph)	218	40	265	8	23	177	249	23	274	352	
Turn Type	custom	NA	custom	custom	NA	Prot	NA	custom	NA	custom	
Protected Phases						5	2				9
Permitted Phases	4	4	4	8	8		2	6	6	6	
Detector Phase	4	4	4	8	8	5	2	6	6	6	
Switch Phase											
Minimum Initial (s)	5.0	5.0	5.0	5.0	5.0	5.0	10.0	10.0	10.0	10.0	7.0
Minimum Split (s)	11.0	11.0	11.0	11.0	11.0	11.0	16.0	16.0	16.0	16.0	24.0
Total Split (s)	24.0	24.0	24.0	24.0	24.0	15.0	42.0	27.0	27.0	27.0	24.0
Total Split (%)	26.7%	26.7%	26.7%	26.7%	26.7%	16.7%	46.7%	30.0%	30.0%	30.0%	27%
Yellow Time (s)	4.0	4.0	4.0	4.0	4.0	4.0	4.0	4.0	4.0	4.0	3.0
All-Red Time (s)	2.0	2.0	2.0	2.0	2.0	2.0	2.0	2.0	2.0	2.0	0.0
Lost Time Adjust (s)		-2.0	0.0		-2.0	-2.0	-2.0		-2.0	0.0	
Total Lost Time (s)		4.0	6.0		4.0	4.0	4.0		4.0	6.0	
Lead/Lag						Lag		Lead	Lead	Lead	
Lead-Lag Optimize?											
Recall Mode	None	None	None	None	None	None	Min	Min	Min	Min	None
Act Effect Green (s)		19.7	17.7		19.7	11.3	35.0		19.5	17.5	
Actuated g/C Ratio		0.30	0.27		0.30	0.17	0.53		0.29	0.26	
v/c Ratio		0.71	0.46		0.09	0.70	0.33		0.65	0.55	
Control Delay		36.0	6.4		17.9	44.6	11.6		29.2	6.2	
Queue Delay		0.0	0.0		0.0	0.0	0.0		0.0	0.0	
Total Delay		36.0	6.4		17.9	44.6	11.6		29.2	6.2	
LOS		D	A		B	D	B		C	A	
Approach Delay		21.0			17.9		24.5		16.7		
Approach LOS		C			B		C		B		

Intersection Summary

Cycle Length: 90
 Actuated Cycle Length: 66.2
 Natural Cycle: 90
 Control Type: Actuated-Uncoordinated
 Maximum v/c Ratio: 0.71
 Intersection Signal Delay: 20.2
 Intersection Capacity Utilization 61.2%
 Analysis Period (min) 15

Intersection LOS: C
 ICU Level of Service B

Splits and Phases: 1: Islington Street & Bartlett Street/Pharmacy Driveway

42 s	24 s	24 s
17 s	15 s	24 s

Queues

1: Islington Street & Bartlett Street/Pharmacy Driveway



Lane Group	EBT	EBR	WBT	NBL	NBT	SBT	SBR
Lane Group Flow (vph)	284	291	46	203	315	334	396
v/c Ratio	0.71	0.46	0.09	0.70	0.33	0.65	0.55
Control Delay	36.0	6.4	17.9	44.6	11.6	29.2	6.2
Queue Delay	0.0	0.0	0.0	0.0	0.0	0.0	0.0
Total Delay	36.0	6.4	17.9	44.6	11.6	29.2	6.2
Queue Length 50th (ft)	94	0	9	75	57	106	0
Queue Length 95th (ft)	#307	64	42	#234	173	#282	66
Internal Link Dist (ft)	144		182		325	372	
Turn Bay Length (ft)		125		150			
Base Capacity (vph)	415	643	507	290	1059	617	792
Starvation Cap Reductn	0	0	0	0	0	0	0
Spillback Cap Reductn	0	0	0	0	0	0	0
Storage Cap Reductn	0	0	0	0	0	0	0
Reduced v/c Ratio	0.68	0.45	0.09	0.70	0.30	0.54	0.50

Intersection Summary

95th percentile volume exceeds capacity, queue may be longer.
 Queue shown is maximum after two cycles.

HCM Signalized Intersection Capacity Analysis

1: Islington Street & Bartlett Street/Pharmacy Driveway



Movement	EBL	EBT	EBR	WBL	WBT	WBR	NBL	NBT	NBR	SBL	SBT	SBR
Lane Configurations		↕	↗		↕		↖	↕			↕	↗
Traffic Volume (vph)	241 ✓	42 ✓	288 ✓	8 ✓	24 ✓	10 ✓	192 ✓	271 ✓	26 ✓	24 ✓	295 ✓	389 ✓
Future Volume (vph)	241	42	288	8	24	10	192	271	26	24	295	389
Ideal Flow (vphpl)	1900	1900	1900	1900	1900	1900	1900	1900	1900	1900	1900	1900
Total Lost time (s)		4.0	6.0		4.0		4.0	4.0			4.0	6.0
Lane Util. Factor		1.00	1.00		1.00		1.00	1.00			1.00	1.00
Flt		1.00	0.85		0.97		1.00	0.99			1.00	0.85
Flt Protected		0.96	1.00		0.99		0.95	1.00			1.00	1.00
Satd. Flow (prot)		1766	1553		1724		1703	1793			1807	1615
Flt Permitted		0.72	1.00		0.92		0.95	1.00			0.95	1.00
Satd. Flow (perm)		1334	1553		1605		1703	1793			1731	1615
Peak-hour factor, PHF	0.91	0.91	0.91	0.88	0.88	0.88	0.87	0.87	0.87	0.89	0.89	0.89
Adj. Flow (vph)	265	46	316	9	27	11	221	311	30	27	331	437
RTOR Reduction (vph)	0	0	228	0	8	0	0	3	0	0	0	318
Lane Group Flow (vph)	0	311	88	0	39	0	221	338	0	0	358	119
Heavy Vehicles (%)	2%	10%	4%	0%	10%	0%	6%	5%	0%	14%	4%	0%
Turn Type	custom	NA	custom	custom	NA		Prot	NA		custom	NA	custom
Protected Phases							5	2				
Permitted Phases	4	4	4	8	8			2		6	6	6
Actuated Green, G (s)		18.3	18.3		18.3		10.2	35.9			19.7	19.7
Effective Green, g (s)		20.3	18.3		20.3		12.2	37.9			21.7	19.7
Actuated g/C Ratio		0.28	0.25		0.28		0.17	0.52			0.30	0.27
Clearance Time (s)		6.0	6.0		6.0		6.0	6.0			6.0	6.0
Vehicle Extension (s)		3.0	3.0		3.0		3.0	3.0			3.0	3.0
Lane Grp Cap (vph)		375	393		451		287	941			520	440
v/s Ratio Prot							c0.13	0.19				
v/s Ratio Perm		c0.23	0.06		0.02						c0.21	0.07
v/c Ratio		0.83	0.22		0.09		0.77	0.36			0.69	0.27
Uniform Delay, d1		24.3	21.3		19.1		28.7	10.0			22.3	20.6
Progression Factor		1.00	1.00		1.00		1.00	1.00			1.00	1.00
Incremental Delay, d2		14.0	0.3		0.1		12.0	0.2			3.8	0.3
Delay (s)		38.4	21.6		19.2		40.7	10.3			26.1	20.9
Level of Service		D	C		B		D	B			C	C
Approach Delay (s)		29.9			19.2			22.2			23.2	
Approach LOS		C			B			C			C	

Intersection Summary

HCM 2000 Control Delay	24.9	HCM 2000 Level of Service	C
HCM 2000 Volume to Capacity ratio	0.77		
Actuated Cycle Length (s)	72.2	Sum of lost time (s)	19.0
Intersection Capacity Utilization	64.9%	ICU Level of Service	C
Analysis Period (min)	15		
c Critical Lane Group			

Timings

1: Islington Street & Bartlett Street/Pharmacy Driveway

Lane Group	EBL	EBT	EBR	WBL	WBT	NBL	NBT	SBL	SBT	SBR	Ø9
Lane Configurations		↔	↗		↔	↖	↗		↔	↖	
Traffic Volume (vph)	241	42	288	8	24	192	271	24	295	389	
Future Volume (vph)	241	42	288	8	24	192	271	24	295	389	
Turn Type	custom	NA	custom	custom	NA	Prot	NA	custom	NA	custom	
Protected Phases						5	2				9
Permitted Phases	4	4	4	8	8		2	6	6	6	
Detector Phase	4	4	4	8	8	5	2	6	6	6	
Switch Phase											
Minimum Initial (s)	5.0	5.0	5.0	5.0	5.0	5.0	10.0	10.0	10.0	10.0	7.0
Minimum Split (s)	11.0	11.0	11.0	11.0	11.0	11.0	16.0	16.0	16.0	16.0	24.0
Total Split (s)	24.0	24.0	24.0	24.0	24.0	16.0	42.0	26.0	26.0	26.0	24.0
Total Split (%)	26.7%	26.7%	26.7%	26.7%	26.7%	17.8%	46.7%	28.9%	28.9%	28.9%	27%
Yellow Time (s)	4.0	4.0	4.0	4.0	4.0	4.0	4.0	4.0	4.0	4.0	3.0
All-Red Time (s)	2.0	2.0	2.0	2.0	2.0	2.0	2.0	2.0	2.0	2.0	0.0
Lost Time Adjust (s)		-2.0	0.0		-2.0	-2.0	-2.0		-2.0	0.0	
Total Lost Time (s)		4.0	6.0		4.0	4.0	4.0		4.0	6.0	
Lead/Lag						Lag		Lead	Lead	Lead	
Lead-Lag Optimize?											
Recall Mode	None	None	None	None	None	None	Min	Min	Min	Min	None
Act Effct Green (s)		20.3	18.3		20.3	12.2	37.9		21.7	19.6	
Actuated g/C Ratio		0.29	0.26		0.29	0.17	0.54		0.31	0.28	
v/c Ratio		0.80	0.50		0.10	0.75	0.35		0.67	0.57	
Control Delay		43.1	7.1		18.2	47.1	11.6		30.3	6.1	
Queue Delay		0.0	0.0		0.0	0.0	0.0		0.0	0.0	
Total Delay		43.1	7.1		18.2	47.1	11.6		30.3	6.1	
LOS		D	A		B	D	B		C	A	
Approach Delay		25.0			18.2		25.6		17.0		
Approach LOS		C			B		C		B		

Intersection Summary

Cycle Length: 90
 Actuated Cycle Length: 69.8
 Natural Cycle: 90
 Control Type: Actuated-Uncoordinated
 Maximum v/c Ratio: 0.80
 Intersection Signal Delay: 21.9
 Intersection Capacity Utilization 64.9%
 Analysis Period (min) 15

Intersection LOS: C
 ICU Level of Service C

Splits and Phases: 1: Islington Street & Bartlett Street/Pharmacy Driveway

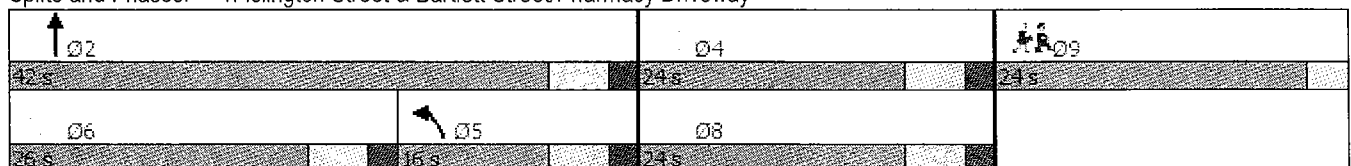

Queues

1: Islington Street & Bartlett Street/Pharmacy Driveway



Lane Group	EBT	EBR	WBT	NBL	NBT	SBT	SBR
Lane Group Flow (vph)	311	316	47	221	341	358	437
v/c Ratio	0.80	0.50	0.10	0.75	0.35	0.67	0.57
Control Delay	43.1	7.1	18.2	47.1	11.6	30.3	6.1
Queue Delay	0.0	0.0	0.0	0.0	0.0	0.0	0.0
Total Delay	43.1	7.1	18.2	47.1	11.6	30.3	6.1
Queue Length 50th (ft)	113	3	10	85	63	119	0
Queue Length 95th (ft)	#345	75	43	#247	189	#327	71
Internal Link Dist (ft)	144		182		325	372	
Turn Bay Length (ft)		125		150			
Base Capacity (vph)	388	631	474	296	993	553	779
Starvation Cap Reductn	0	0	0	0	0	0	0
Spillback Cap Reductn	0	0	0	0	0	0	0
Storage Cap Reductn	0	0	0	0	0	0	0
Reduced v/c Ratio	0.80	0.50	0.10	0.75	0.34	0.65	0.56

Intersection Summary

- # 95th percentile volume exceeds capacity, queue may be longer.
Queue shown is maximum after two cycles.

HCM Signalized Intersection Capacity Analysis

1: Islington Street & Bartlett Street/Pharmacy Driveway

Movement	EBL	EBT	EBR	WBL	WBT	WBR	NBL	NBT	NBR	SBL	SBT	SBR
Lane Configurations												
Traffic Volume (vph)	225 ✓	40 ✓	272 ✓	8 ✓	23 ✓	10 ✓	179 ✓	249 ✓	25 ✓	23 ✓	274 ✓	356 ✓
Future Volume (vph)	225	40	272	8	23	10	179	249	25	23	274	356
Ideal Flow (vphpl)	1900	1900	1900	1900	1900	1900	1900	1900	1900	1900	1900	1900
Total Lost time (s)		4.0	6.0		4.0		4.0	4.0			4.0	6.0
Lane Util. Factor		1.00	1.00		1.00		1.00	1.00			1.00	1.00
Fr't		1.00	0.85		0.97		1.00	0.99			1.00	0.85
Flt Protected		0.96	1.00		0.99		0.95	1.00			1.00	1.00
Satd. Flow (prot)		1766	1553		1723		1703	1792			1806	1615
Flt Permitted		0.73	1.00		0.92		0.95	1.00			0.95	1.00
Satd. Flow (perm)		1337	1553		1608		1703	1792			1731	1615
Peak-hour factor, PHF	0.91	0.91	0.91	0.88	0.88	0.88	0.87	0.87	0.87	0.89	0.89	0.89
Adj. Flow (vph)	247	44	299	9	26	11	206	286	29	26	308	400
RTOR Reduction (vph)	0	0	221	0	8	0	0	3	0	0	0	298
Lane Group Flow (vph)	0	291	78	0	38	0	206	312	0	0	334	102
Heavy Vehicles (%)	2%	10%	4%	0%	10%	0%	6%	5%	0%	14%	4%	0%
Turn Type	custom	NA	custom	custom	NA		Prot	NA		custom	NA	custom
Protected Phases							5	2				
Permitted Phases	4	4	4	8	8			2		6	6	6
Actuated Green, G (s)		17.9	17.9		17.9		9.4	32.9			17.5	17.5
Effective Green, g (s)		19.9	17.9		19.9		11.4	34.9			19.5	17.5
Actuated g/C Ratio		0.29	0.26		0.29		0.17	0.51			0.28	0.25
Clearance Time (s)		6.0	6.0		6.0		6.0	6.0			6.0	6.0
Vehicle Extension (s)		3.0	3.0		3.0		3.0	3.0			3.0	3.0
Lane Grp Cap (vph)		387	404		465		282	910			491	411
v/s Ratio Prot							c0.12	0.17				
v/s Ratio Perm		c0.22	0.05		0.02						c0.19	0.06
v/c Ratio		0.75	0.19		0.08		0.73	0.34			0.68	0.25
Uniform Delay, d1		22.2	19.8		17.8		27.2	10.1			21.8	20.4
Progression Factor		1.00	1.00		1.00		1.00	1.00			1.00	1.00
Incremental Delay, d2		8.0	0.2		0.1		9.3	0.2			3.9	0.3
Delay (s)		30.2	20.0		17.8		36.5	10.3			25.7	20.7
Level of Service		C	C		B		D	B			C	C
Approach Delay (s)		25.0			17.8			20.7			23.0	
Approach LOS		C			B			C			C	
Intersection Summary												
HCM 2000 Control Delay			22.8				HCM 2000 Level of Service				C	
HCM 2000 Volume to Capacity ratio			0.73									
Actuated Cycle Length (s)			68.7						19.0			
Intersection Capacity Utilization			61.5%									
Analysis Period (min)			15									
c Critical Lane Group												

Timings

1: Islington Street & Bartlett Street/Pharmacy Driveway

											Ø9
Lane Group	EBL	EBT	EBR	WBL	WBT	NBL	NBT	SBL	SBT	SBR	Ø9
Lane Configurations											
Traffic Volume (vph)	225	40	272	8	23	179	249	23	274	356	
Future Volume (vph)	225	40	272	8	23	179	249	23	274	356	
Turn Type	custom	NA	custom	custom	NA	Prot	NA	custom	NA	custom	
Protected Phases						5	2				9
Permitted Phases	4	4	4	8	8		2	6	6	6	
Detector Phase	4	4	4	8	8	5	2	6	6	6	
Switch Phase											
Minimum Initial (s)	5.0	5.0	5.0	5.0	5.0	5.0	10.0	10.0	10.0	10.0	7.0
Minimum Split (s)	11.0	11.0	11.0	11.0	11.0	11.0	16.0	16.0	16.0	16.0	24.0
Total Split (s)	24.0	24.0	24.0	24.0	24.0	15.0	42.0	27.0	27.0	27.0	24.0
Total Split (%)	26.7%	26.7%	26.7%	26.7%	26.7%	16.7%	46.7%	30.0%	30.0%	30.0%	27%
Yellow Time (s)	4.0	4.0	4.0	4.0	4.0	4.0	4.0	4.0	4.0	4.0	3.0
All-Red Time (s)	2.0	2.0	2.0	2.0	2.0	2.0	2.0	2.0	2.0	2.0	0.0
Lost Time Adjust (s)		-2.0	0.0		-2.0	-2.0	-2.0		-2.0	0.0	
Total Lost Time (s)		4.0	6.0		4.0	4.0	4.0		4.0	6.0	
Lead/Lag						Lag		Lead	Lead	Lead	
Lead-Lag Optimize?											
Recall Mode	None	None	None	None	None	None	Min	Min	Min	Min	None
Act Effct Green (s)		20.0	17.9		20.0	11.3	34.9		19.5	17.5	
Actuated g/C Ratio		0.30	0.27		0.30	0.17	0.53		0.29	0.26	
v/c Ratio		0.73	0.47		0.09	0.71	0.33		0.66	0.56	
Control Delay		36.6	6.4		17.9	45.5	11.6		29.3	6.2	
Queue Delay		0.0	0.0		0.0	0.0	0.0		0.0	0.0	
Total Delay		36.6	6.4		17.9	45.5	11.6		29.3	6.2	
LOS		D	A		B	D	B		C	A	
Approach Delay		21.3			17.9		25.0		16.7		
Approach LOS		C			B		C		B		

Intersection Summary

Cycle Length: 90
 Actuated Cycle Length: 66.4
 Natural Cycle: 90
 Control Type: Actuated-Uncoordinated
 Maximum v/c Ratio: 0.73
 Intersection Signal Delay: 20.5
 Intersection Capacity Utilization 61.5%
 Analysis Period (min) 15

Intersection LOS: C
 ICU Level of Service B

Splits and Phases: 1: Islington Street & Bartlett Street/Pharmacy Driveway

42 s	24 s	24 s
27 s	15 s	24 s

Queues

1: Islington Street & Bartlett Street/Pharmacy Driveway



Lane Group	EBT	EBR	WBT	NBL	NBT	SBT	SBR
Lane Group Flow (vph)	291	299	46	206	315	334	400
v/c Ratio	0.73	0.47	0.09	0.71	0.33	0.66	0.56
Control Delay	36.6	6.4	17.9	45.5	11.6	29.3	6.2
Queue Delay	0.0	0.0	0.0	0.0	0.0	0.0	0.0
Total Delay	36.6	6.4	17.9	45.5	11.6	29.3	6.2
Queue Length 50th (ft)	97	0	9	76	57	106	0
Queue Length 95th (ft)	#316	65	42	#239	173	#282	67
Internal Link Dist (ft)	144		182		325	372	
Turn Bay Length (ft)		125		150			
Base Capacity (vph)	412	647	504	289	1054	614	794
Starvation Cap Reductn	0	0	0	0	0	0	0
Spillback Cap Reductn	0	0	0	0	0	0	0
Storage Cap Reductn	0	0	0	0	0	0	0
Reduced v/c Ratio	0.71	0.46	0.09	0.71	0.30	0.54	0.50

Intersection Summary

95th percentile volume exceeds capacity, queue may be longer.
 Queue shown is maximum after two cycles.

HCM Signalized Intersection Capacity Analysis

1: Islington Street & Bartlett Street/Pharmacy Driveway

Movement	EBL	EBT	EBR	WBL	WBT	WBR	NBL	NBT	NBR	SBL	SBT	SBR
Lane Configurations												
Traffic Volume (vph)	248 ✓	42 ✓	295 ✓	8 ✓	24 ✓	10 ✓	194 ✓	271 ✓	26 ✓	24 ✓	295 ✓	393 ✓
Future Volume (vph)	248	42	295	8	24	10	194	271	26	24	295	393
Ideal Flow (vphpl)	1900	1900	1900	1900	1900	1900	1900	1900	1900	1900	1900	1900
Total Lost time (s)		4.0	6.0		4.0		4.0	4.0			4.0	6.0
Lane Util. Factor		1.00	1.00		1.00		1.00	1.00			1.00	1.00
Frt		1.00	0.85		0.97		1.00	0.99			1.00	0.85
Flt Protected		0.96	1.00		0.99		0.95	1.00			1.00	1.00
Satd. Flow (prot)		1766	1553		1724		1703	1793			1807	1615
Flt Permitted		0.72	1.00		0.92		0.95	1.00			0.95	1.00
Satd. Flow (perm)		1333	1553		1604		1703	1793			1731	1615
Peak-hour factor, PHF	0.91	0.91	0.91	0.88	0.88	0.88	0.87	0.87	0.87	0.89	0.89	0.89
Adj. Flow (vph)	273	46	324	9	27	11	223	311	30	27	331	442
RTOR Reduction (vph)	0	0	226	0	8	0	0	3	0	0	0	321
Lane Group Flow (vph)	0	319	98	0	39	0	223	338	0	0	358	121
Heavy Vehicles (%)	2%	10%	4%	0%	10%	0%	6%	5%	0%	14%	4%	0%
Turn Type	custom	NA	custom	custom	NA		Prot	NA		custom	NA	custom
Protected Phases							5	2				
Permitted Phases	4	4	4	8	8			2		6	6	6
Actuated Green, G (s)		18.3	18.3		18.3		9.3	34.8			19.5	19.5
Effective Green, g (s)		20.3	18.3		20.3		11.3	36.8			21.5	19.5
Actuated g/C Ratio		0.29	0.26		0.29		0.16	0.52			0.30	0.27
Clearance Time (s)		6.0	6.0		6.0		6.0	6.0			6.0	6.0
Vehicle Extension (s)		3.0	3.0		3.0		3.0	3.0			3.0	3.0
Lane Grp Cap (vph)		380	399		457		270	928			523	442
v/s Ratio Prot							c0.13	0.19				
v/s Ratio Perm		c0.24	0.06		0.02						c0.21	0.08
v/c Ratio		0.84	0.24		0.09		0.83	0.36			0.68	0.27
Uniform Delay, d1		23.9	20.9		18.6		28.9	10.2			21.8	20.2
Progression Factor		1.00	1.00		1.00		1.00	1.00			1.00	1.00
Incremental Delay, d2		14.9	0.3		0.1		18.3	0.2			3.7	0.3
Delay (s)		38.8	21.2		18.7		47.2	10.4			25.5	20.6
Level of Service		D	C		B		D	B			C	C
Approach Delay (s)		30.0			18.7			25.0			22.8	
Approach LOS		C			B			C			C	

Intersection Summary

HCM 2000 Control Delay	25.5	HCM 2000 Level of Service	C
HCM 2000 Volume to Capacity ratio	0.79		
Actuated Cycle Length (s)	71.1	Sum of lost time (s)	19.0
Intersection Capacity Utilization	65.3%	ICU Level of Service	C
Analysis Period (min)	15		
c Critical Lane Group			

Timings

1: Islington Street & Bartlett Street/Pharmacy Driveway

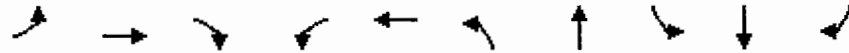

Lane Group	EBL	EBT	EBR	WBL	WBT	NBL	NBT	SBL	SBT	SBR	Ø9
Lane Configurations		↕	↗		↕	↖	↖		↕	↗	
Traffic Volume (vph)	248	42	295	8	24	194	271	24	295	393	
Future Volume (vph)	248	42	295	8	24	194	271	24	295	393	
Turn Type	custom	NA	custom	custom	NA	Prot	NA	custom	NA	custom	
Protected Phases						5	2				9
Permitted Phases	4	4	4	8	8		2	6	6	6	
Detector Phase	4	4	4	8	8	5	2	6	6	6	
Switch Phase											
Minimum Initial (s)	5.0	5.0	5.0	5.0	5.0	5.0	10.0	10.0	10.0	10.0	7.0
Minimum Split (s)	11.0	11.0	11.0	11.0	11.0	11.0	16.0	16.0	16.0	16.0	24.0
Total Split (s)	24.0	24.0	24.0	24.0	24.0	15.0	42.0	27.0	27.0	27.0	24.0
Total Split (%)	26.7%	26.7%	26.7%	26.7%	26.7%	16.7%	46.7%	30.0%	30.0%	30.0%	27%
Yellow Time (s)	4.0	4.0	4.0	4.0	4.0	4.0	4.0	4.0	4.0	4.0	3.0
All-Red Time (s)	2.0	2.0	2.0	2.0	2.0	2.0	2.0	2.0	2.0	2.0	0.0
Lost Time Adjust (s)		-2.0	0.0		-2.0	-2.0	-2.0		-2.0	0.0	
Total Lost Time (s)		4.0	6.0		4.0	4.0	4.0		4.0	6.0	
Lead/Lag						Lag		Lead	Lead	Lead	
Lead-Lag Optimize?											
Recall Mode	None	None	None	None	None	None	Min	Min	Min	Min	None
Act Effct Green (s)		20.4	18.3		20.4	11.2	36.8		21.6	19.5	
Actuated g/C Ratio		0.30	0.27		0.30	0.16	0.53		0.31	0.28	
v/c Ratio		0.81	0.51		0.10	0.81	0.35		0.66	0.57	
Control Delay		43.2	7.5		18.2	54.2	11.8		29.3	6.0	
Queue Delay		0.0	0.0		0.0	0.0	0.0		0.0	0.0	
Total Delay		43.2	7.5		18.2	54.2	11.8		29.3	6.0	
LOS		D	A		B	D	B		C	A	
Approach Delay		25.2			18.2		28.5		16.4		
Approach LOS		C			B		C		B		

Intersection Summary

Cycle Length: 90
 Actuated Cycle Length: 68.8
 Natural Cycle: 90
 Control Type: Actuated-Uncoordinated
 Maximum v/c Ratio: 0.81
 Intersection Signal Delay: 22.6
 Intersection Capacity Utilization 65.3%
 Analysis Period (min) 15
 Intersection LOS: C
 ICU Level of Service C

Splits and Phases: 1: Islington Street & Bartlett Street/Pharmacy Driveway

↑ Ø2		Ø4	↖ Ø9
42 s		24 s	24 s
Ø6	↖ Ø5	Ø8	
27 s	15 s	24 s	

Queues

1: Islington Street & Bartlett Street/Pharmacy Driveway



Lane Group	EBT	EBR	WBT	NBL	NBT	SBT	SBR
Lane Group Flow (vph)	319	324	47	223	341	358	442
v/c Ratio	0.81	0.51	0.10	0.81	0.35	0.66	0.57
Control Delay	43.2	7.5	18.2	54.2	11.8	29.3	6.0
Queue Delay	0.0	0.0	0.0	0.0	0.0	0.0	0.0
Total Delay	43.2	7.5	18.2	54.2	11.8	29.3	6.0
Queue Length 50th (ft)	116	6	10	87	63	116	0
Queue Length 95th (ft)	#355	81	43	#262	189	#315	70
Internal Link Dist (ft)	144		182		325	372	
Turn Bay Length (ft)		125		150			
Base Capacity (vph)	395	637	482	276	1011	588	806
Starvation Cap Reductn	0	0	0	0	0	0	0
Spillback Cap Reductn	0	0	0	0	0	0	0
Storage Cap Reductn	0	0	0	0	0	0	0
Reduced v/c Ratio	0.81	0.51	0.10	0.81	0.34	0.61	0.55

Intersection Summary

95th percentile volume exceeds capacity, queue may be longer.
 Queue shown is maximum after two cycles.

HCM Signalized Intersection Capacity Analysis

1: Islington Street & Bartlett Street/Pharmacy Driveway



Movement	EBL	EBT	EBR	WBL	WBT	WBR	NBL	NBT	NBR	SBL	SBT	SBR
Lane Configurations		↔	↔	↔	↔	↔	↔	↔	↔	↔	↔	↔
Traffic Volume (vph)	312 ✓	18 ✓	320 ✓	10 ✓	21 ✓	12 ✓	242 ✓	244 ✓	11 ✓	18 ✓	309 ✓	241 ✓
Future Volume (vph)	312	18	320	10	21	12	242	244	11	18	309	241
Ideal Flow (vphpl)	1900	1900	1900	1900	1900	1900	1900	1900	1900	1900	1900	1900
Total Lost time (s)		4.0	6.0		4.0		4.0	4.0			4.0	6.0
Lane Util. Factor		1.00	1.00		1.00		1.00	1.00			1.00	1.00
Frt		1.00	0.85		0.96		1.00	0.99			1.00	0.85
Flt Protected		0.95	1.00		0.99		0.95	1.00			1.00	1.00
Satd. Flow (prot)		1797	1599		1807		1787	1870			1877	1615
Flt Permitted		0.74	1.00		0.89		0.95	1.00			0.97	1.00
Satd. Flow (perm)		1396	1599		1630		1787	1870			1827	1615
Peak-hour factor, PHF	0.95	0.95	0.95	0.63	0.63	0.63	0.89	0.89	0.89	0.90	0.90	0.90
Adj. Flow (vph)	328	19	337	16	33	19	272	274	12	20	343	268
RTOR Reduction (vph)	0	0	216	0	13	0	0	1	0	0	0	205
Lane Group Flow (vph)	0	347	121	0	55	0	272	285	0	0	363	63
Heavy Vehicles (%)	1%	0%	1%	0%	0%	0%	1%	1%	0%	0%	1%	0%
Turn Type	custom	NA	custom	custom	NA		Prot	NA		custom	NA	custom
Protected Phases							5	2				
Permitted Phases	4	4	4	8	8			2		6	6	6
Actuated Green, G (s)		20.3	20.3		20.3		11.3	34.5			17.2	17.2
Effective Green, g (s)		22.3	20.3		22.3		13.3	36.5			19.2	17.2
Actuated g/C Ratio		0.31	0.28		0.31		0.18	0.50			0.26	0.24
Clearance Time (s)		6.0	6.0		6.0		6.0	6.0			6.0	6.0
Vehicle Extension (s)		3.0	3.0		3.0		3.0	3.0			3.0	3.0
Lane Grp Cap (vph)		427	445		499		326	937			481	381
v/s Ratio Prot							c0.15	0.15				
v/s Ratio Perm		c0.25	0.08		0.03						c0.20	0.04
v/c Ratio		0.81	0.27		0.11		0.83	0.30			0.75	0.17
Uniform Delay, d1		23.3	20.5		18.1		28.7	10.7			24.6	22.1
Progression Factor		1.00	1.00		1.00		1.00	1.00			1.00	1.00
Incremental Delay, d2		11.2	0.3		0.1		16.6	0.2			6.6	0.2
Delay (s)		34.6	20.8		18.2		45.3	10.9			31.3	22.3
Level of Service		C	C		B		D	B			C	C
Approach Delay (s)		27.8			18.2			27.6			27.5	
Approach LOS		C			B			C			C	

Intersection Summary

HCM 2000 Control Delay	27.3	HCM 2000 Level of Service	C
HCM 2000 Volume to Capacity ratio	0.81		
Actuated Cycle Length (s)	72.8	Sum of lost time (s)	19.0
Intersection Capacity Utilization	65.7%	ICU Level of Service	C
Analysis Period (min)	15		
c Critical Lane Group			

Timings

1: Islington Street & Bartlett Street/Pharmacy Driveway

											Ø9
Lane Group	EBL	EBT	EBR	WBL	WBT	NBL	NBT	SBL	SBT	SBR	Ø9
Lane Configurations											
Traffic Volume (vph)	312	18	320	10	21	242	244	18	309	241	
Future Volume (vph)	312	18	320	10	21	242	244	18	309	241	
Turn Type	custom	NA	custom	custom	NA	Prot	NA	custom	NA	custom	
Protected Phases						5	2				9
Permitted Phases	4	4	4	8	8		2	6	6	6	
Detector Phase	4	4	4	8	8	5	2	6	6	6	
Switch Phase											
Minimum Initial (s)	5.0	5.0	5.0	5.0	5.0	5.0	10.0	10.0	10.0	10.0	7.0
Minimum Split (s)	11.0	11.0	11.0	11.0	11.0	16.0	16.0	16.0	16.0	16.0	24.0
Total Split (s)	26.0	26.0	26.0	26.0	26.0	17.0	40.0	23.0	23.0	23.0	24.0
Total Split (%)	28.9%	28.9%	28.9%	28.9%	28.9%	18.9%	44.4%	25.6%	25.6%	25.6%	27%
Yellow Time (s)	4.0	4.0	4.0	4.0	4.0	4.0	4.0	4.0	4.0	4.0	3.0
All-Red Time (s)	2.0	2.0	2.0	2.0	2.0	2.0	2.0	2.0	2.0	2.0	0.0
Lost Time Adjust (s)		-2.0	0.0		-2.0	-2.0	-2.0		-2.0	0.0	
Total Lost Time (s)		4.0	6.0		4.0	4.0	4.0		4.0	6.0	
Lead/Lag						Lag		Lead	Lead	Lead	
Lead-Lag Optimize?											
Recall Mode	None	None	None	None	None	None	Min	Min	Min	Min	None
Act Effct Green (s)		22.3	20.3		22.3	13.2	36.5		19.3	17.2	
Actuated g/C Ratio		0.32	0.29		0.32	0.19	0.52		0.27	0.24	
v/c Ratio		0.79	0.50		0.13	0.82	0.29		0.73	0.45	
Control Delay		38.9	7.6		16.3	50.6	12.2		35.4	6.6	
Queue Delay		0.0	0.0		0.0	0.0	0.0		0.0	0.0	
Total Delay		38.9	7.6		16.3	50.6	12.2		35.4	6.6	
LOS		D	A		B	D	B		D	A	
Approach Delay		23.5			16.3		30.9		23.2		
Approach LOS		C			B		C		C		

Intersection Summary

Cycle Length: 90
 Actuated Cycle Length: 70.4
 Natural Cycle: 90
 Control Type: Actuated-Uncoordinated
 Maximum v/c Ratio: 0.82
 Intersection Signal Delay: 25.3
 Intersection Capacity Utilization 65.7%
 Analysis Period (min) 15
 Intersection LOS: C
 ICU Level of Service C

Splits and Phases: 1: Islington Street & Bartlett Street/Pharmacy Driveway

30 s	25 s	24 s
22 s	17 s	26 s

Queues

1: Islington Street & Bartlett Street/Pharmacy Driveway



Lane Group	EBT	EBR	WBT	NBL	NBT	SBT	SBR
Lane Group Flow (vph)	347	337	68	272	286	363	268
v/c Ratio	0.79	0.50	0.13	0.82	0.29	0.73	0.45
Control Delay	38.9	7.6	16.3	50.6	12.2	35.4	6.6
Queue Delay	0.0	0.0	0.0	0.0	0.0	0.0	0.0
Total Delay	38.9	7.6	16.3	50.6	12.2	35.4	6.6
Queue Length 50th (ft)	122	11	13	105	56	129	0
Queue Length 95th (ft)	#367	91	35	#309	168	#362	63
Internal Link Dist (ft)	144		182		325	372	
Turn Bay Length (ft)		125		150			
Base Capacity (vph)	442	673	528	333	970	499	597
Starvation Cap Reductn	0	0	0	0	0	0	0
Spillback Cap Reductn	0	0	0	0	0	0	0
Storage Cap Reductn	0	0	0	0	0	0	0
Reduced v/c Ratio	0.79	0.50	0.13	0.82	0.29	0.73	0.45

Intersection Summary

95th percentile volume exceeds capacity, queue may be longer.
 Queue shown is maximum after two cycles.

HCM Signalized Intersection Capacity Analysis

1: Islington Street & Bartlett Street/Pharmacy Driveway

Movement	EBL	EBT	EBR	WBL	WBT	WBR	NBL	NBT	NBR	SBL	SBT	SBR
Lane Configurations												
Traffic Volume (vph)	330	38	386	27	45	21	312	377	25	35	344	260
Future Volume (vph)	330	38	386	27	45	21	312	377	25	35	344	260
Ideal Flow (vphpl)	1900	1900	1900	1900	1900	1900	1900	1900	1900	1900	1900	1900
Total Lost time (s)		4.0	6.0		4.0		4.0	4.0			4.0	6.0
Lane Util. Factor		1.00	1.00		1.00		1.00	1.00			1.00	1.00
Frt		1.00	0.85		0.97		1.00	0.99			1.00	0.85
Flt Protected		0.96	1.00		0.99		0.95	1.00			1.00	1.00
Satd. Flow (prot)		1802	1599		1816		1787	1865			1874	1615
Flt Permitted		0.61	1.00		0.61		0.95	1.00			0.86	1.00
Satd. Flow (perm)		1157	1599		1115		1787	1865			1625	1615
Peak-hour factor, PHF	0.95	0.95	0.95	0.63	0.63	0.63	0.89	0.89	0.89	0.90	0.90	0.90
Adj. Flow (vph)	347	40	406	43	71	33	351	424	28	39	382	289
RTOR Reduction (vph)	0	0	178	0	8	0	0	2	0	0	0	198
Lane Group Flow (vph)	0	387	228	0	139	0	351	450	0	0	421	91
Heavy Vehicles (%)	1%	0%	1%	0%	0%	0%	1%	1%	0%	0%	1%	0%
Turn Type	custom	NA	custom	custom	NA		Prot	NA		custom	NA	custom
Protected Phases							5	2				
Permitted Phases	4	4	4	8	8			2		6	6	6
Actuated Green, G (s)		29.2	29.2		29.2		17.2	55.4			32.2	32.2
Effective Green, g (s)		31.2	29.2		31.2		19.2	57.4			34.2	32.2
Actuated g/C Ratio		0.30	0.28		0.30		0.19	0.56			0.33	0.31
Clearance Time (s)		6.0	6.0		6.0		6.0	6.0			6.0	6.0
Vehicle Extension (s)		3.0	3.0		3.0		3.0	3.0			3.0	3.0
Lane Grp Cap (vph)		351	454		338		333	1041			540	505
v/s Ratio Prot							c0.20	0.24				
v/s Ratio Perm		c0.33	0.14		0.12						c0.26	0.06
v/c Ratio		1.10	0.50		0.41		1.05	0.43			0.78	0.18
Uniform Delay, d1		35.8	30.7		28.5		41.8	13.2			30.9	25.7
Progression Factor		1.00	1.00		1.00		1.00	1.00			1.00	1.00
Incremental Delay, d2		78.5	0.9		0.8		64.2	0.3			7.0	0.2
Delay (s)		114.3	31.6		29.3		106.0	13.5			37.9	25.9
Level of Service		F	C		C		F	B			D	C
Approach Delay (s)		72.0			29.3			54.0			33.0	
Approach LOS		E			C			D			C	

Intersection Summary

HCM 2000 Control Delay	52.2	HCM 2000 Level of Service	D
HCM 2000 Volume to Capacity ratio	0.97		
Actuated Cycle Length (s)	102.8	Sum of lost time (s)	19.0
Intersection Capacity Utilization	78.3%	ICU Level of Service	D
Analysis Period (min)	15		
c Critical Lane Group			

Timings

1: Islington Street & Bartlett Street/Pharmacy Driveway

											Ø9
Lane Group	EBL	EBT	EBR	WBL	WBT	NBL	NBT	SBL	SBT	SBR	Ø9
Lane Configurations											
Traffic Volume (vph)	330	38	386	27	45	312	377	35	344	260	
Future Volume (vph)	330	38	386	27	45	312	377	35	344	260	
Turn Type	custom	NA	custom	custom	NA	Prot	NA	custom	NA	custom	
Protected Phases						5	2				9
Permitted Phases	4	4	4	8	8		2	6	6	6	
Detector Phase	4	4	4	8	8	5	2	6	6	6	
Switch Phase											
Minimum Initial (s)	5.0	5.0	5.0	5.0	5.0	5.0	10.0	10.0	10.0	10.0	7.0
Minimum Split (s)	11.0	11.0	11.0	11.0	11.0	16.0	16.0	16.0	16.0	16.0	24.0
Total Split (s)	35.0	35.0	35.0	35.0	35.0	23.0	61.0	38.0	38.0	38.0	24.0
Total Split (%)	29.2%	29.2%	29.2%	29.2%	29.2%	19.2%	50.8%	31.7%	31.7%	31.7%	20%
Yellow Time (s)	4.0	4.0	4.0	4.0	4.0	4.0	4.0	4.0	4.0	4.0	3.0
All-Red Time (s)	2.0	2.0	2.0	2.0	2.0	2.0	2.0	2.0	2.0	2.0	0.0
Lost Time Adjust (s)		-2.0	0.0		-2.0	-2.0	-2.0		-2.0	0.0	
Total Lost Time (s)		4.0	6.0		4.0	4.0	4.0		4.0	6.0	
Lead/Lag						Lag		Lead	Lead	Lead	
Lead-Lag Optimize?											
Recall Mode	None	None	None	None	None	None	Min	Min	Min	Min	None
Act Effct Green (s)		31.2	29.2		31.2	19.1	57.4		34.2	32.2	
Actuated g/C Ratio		0.31	0.29		0.31	0.19	0.57		0.34	0.32	
v/c Ratio		1.08	0.63		0.41	1.03	0.42		0.76	0.40	
Control Delay		104.7	17.4		31.1	99.0	14.9		41.1	5.4	
Queue Delay		0.0	0.0		0.0	0.0	0.0		0.0	0.0	
Total Delay		104.7	17.4		31.1	99.0	14.9		41.1	5.4	
LOS		F	B		C	F	B		D	A	
Approach Delay		60.0			31.1		51.6		26.6		
Approach LOS		E			C		D		C		

Intersection Summary

Cycle Length: 120

Actuated Cycle Length: 100.4

Natural Cycle: 150

Control Type: Actuated-Uncoordinated

Maximum v/c Ratio: 1.08

Intersection Signal Delay: 45.9

Intersection Capacity Utilization 78.3%

Analysis Period (min) 15

Intersection LOS: D

ICU Level of Service D

Splits and Phases: 1: Islington Street & Bartlett Street/Pharmacy Driveway

Ø1 s	Ø3 s	Ø4 s
Ø6 s	Ø6 s	Ø5 s

Queues

1: Islington Street & Bartlett Street/Pharmacy Driveway

























Lane Group	EBT	EBR	WBT	NBL	NBT	SBT	SBR
Lane Group Flow (vph)	387	406	147	351	452	421	289
v/c Ratio	1.08	0.63	0.41	1.03	0.42	0.76	0.40
Control Delay	104.7	17.4	31.1	99.0	14.9	41.1	5.4
Queue Delay	0.0	0.0	0.0	0.0	0.0	0.0	0.0
Total Delay	104.7	17.4	31.1	99.0	14.9	41.1	5.4
Queue Length 50th (ft)	~256	75	63	215	135	221	0
Queue Length 95th (ft)	#565	227	98	#507	314	#494	66
Internal Link Dist (ft)	144		182		325	372	
Turn Bay Length (ft)		125		150			
Base Capacity (vph)	359	641	355	340	1067	554	714
Starvation Cap Reductn	0	0	0	0	0	0	0
Spillback Cap Reductn	0	0	0	0	0	0	0
Storage Cap Reductn	0	0	0	0	0	0	0
Reduced v/c Ratio	1.08	0.63	0.41	1.03	0.42	0.76	0.40

Intersection Summary

- ~ Volume exceeds capacity, queue is theoretically infinite.
Queue shown is maximum after two cycles.
- # 95th percentile volume exceeds capacity, queue may be longer.
Queue shown is maximum after two cycles.

HCM Signalized Intersection Capacity Analysis

1: Islington Street & Bartlett Street/Pharmacy Driveway

												
Movement	EBL	EBT	EBR	WBL	WBT	WBR	NBL	NBT	NBR	SBL	SBT	SBR
Lane Configurations												
Traffic Volume (vph)	365	40	422	28	47	22	339	404	26	37	378	287
Future Volume (vph)	365	40	422	28	47	22	339	404	26	37	378	287
Ideal Flow (vphpl)	1900	1900	1900	1900	1900	1900	1900	1900	1900	1900	1900	1900
Total Lost time (s)		4.0	6.0		4.0		4.0	4.0			4.0	6.0
Lane Util. Factor		1.00	1.00		1.00		1.00	1.00			1.00	1.00
Frt		1.00	0.85		0.97		1.00	0.99			1.00	0.85
Flt Protected		0.96	1.00		0.99		0.95	1.00			1.00	1.00
Satd. Flow (prot)		1802	1599		1816		1787	1865			1875	1615
Flt Permitted		0.60	1.00		0.53		0.95	1.00			0.81	1.00
Satd. Flow (perm)		1138	1599		982		1787	1865			1532	1615
Peak-hour factor, PHF	0.95	0.95	0.95	0.63	0.63	0.63	0.89	0.89	0.89	0.90	0.90	0.90
Adj. Flow (vph)	384	42	444	44	75	35	381	454	29	41	420	319
RTOR Reduction (vph)	0	0	177	0	8	0	0	2	0	0	0	214
Lane Group Flow (vph)	0	426	267	0	146	0	381	481	0	0	461	105
Heavy Vehicles (%)	1%	0%	1%	0%	0%	0%	1%	1%	0%	0%	1%	0%
Turn Type	custom	NA	custom	custom	NA		Prot	NA		custom	NA	custom
Protected Phases							5	2				
Permitted Phases	4	4	4	8	8			2		6	6	6
Actuated Green, G (s)		29.2	29.2		29.2		17.2	55.4			32.2	32.2
Effective Green, g (s)		31.2	29.2		31.2		19.2	57.4			34.2	32.2
Actuated g/C Ratio		0.30	0.28		0.30		0.19	0.56			0.33	0.31
Clearance Time (s)		6.0	6.0		6.0		6.0	6.0			6.0	6.0
Vehicle Extension (s)		3.0	3.0		3.0		3.0	3.0			3.0	3.0
Lane Grp Cap (vph)		345	454		298		333	1041			509	505
v/s Ratio Prot							0.21	0.26				
v/s Ratio Perm		0.37	0.17		0.15						0.30	0.07
v/c Ratio		1.23	0.59		0.49		1.14	0.46			0.91	0.21
Uniform Delay, d1		35.8	31.6		29.3		41.8	13.5			32.8	25.9
Progression Factor		1.00	1.00		1.00		1.00	1.00			1.00	1.00
Incremental Delay, d2		128.3	2.0		1.3		94.4	0.3			19.5	0.2
Delay (s)		164.1	33.6		30.5		136.2	13.8			52.3	26.1
Level of Service		F	C		C		F	B			D	C
Approach Delay (s)		97.5			30.5			67.8			41.6	
Approach LOS		F			C			E			D	

Intersection Summary

HCM 2000 Control Delay	67.7	HCM 2000 Level of Service	E
HCM 2000 Volume to Capacity ratio	1.09		
Actuated Cycle Length (s)	102.8	Sum of lost time (s)	19.0
Intersection Capacity Utilization	83.8%	ICU Level of Service	E
Analysis Period (min)	15		
c Critical Lane Group			

Timings

1: Islington Street & Bartlett Street/Pharmacy Driveway

											Ø9
Lane Group	EBL	EBT	EBR	WBL	WBT	NBL	NBT	SBL	SBT	SBR	Ø9
Lane Configurations											
Traffic Volume (vph)	365	40	422	28	47	339	404	37	378	287	
Future Volume (vph)	365	40	422	28	47	339	404	37	378	287	
Turn Type	custom	NA	custom	custom	NA	Prot	NA	custom	NA	custom	
Protected Phases						5	2				9
Permitted Phases	4	4	4	8	8		2	6	6	6	
Detector Phase	4	4	4	8	8	5	2	6	6	6	
Switch Phase											
Minimum Initial (s)	5.0	5.0	5.0	5.0	5.0	5.0	10.0	10.0	10.0	10.0	7.0
Minimum Split (s)	11.0	11.0	11.0	11.0	11.0	16.0	16.0	16.0	16.0	16.0	24.0
Total Split (s)	35.0	35.0	35.0	35.0	35.0	23.0	61.0	38.0	38.0	38.0	24.0
Total Split (%)	29.2%	29.2%	29.2%	29.2%	29.2%	19.2%	50.8%	31.7%	31.7%	31.7%	20%
Yellow Time (s)	4.0	4.0	4.0	4.0	4.0	4.0	4.0	4.0	4.0	4.0	3.0
All-Red Time (s)	2.0	2.0	2.0	2.0	2.0	2.0	2.0	2.0	2.0	2.0	0.0
Lost Time Adjust (s)		-2.0	0.0		-2.0	-2.0	-2.0		-2.0	0.0	
Total Lost Time (s)		4.0	6.0		4.0	4.0	4.0		4.0	6.0	
Lead/Lag						Lag		Lead	Lead	Lead	
Lead-Lag Optimize?											
Recall Mode	None	None	None	None	None	None	Min	Min	Min	Min	None
Act Effct Green (s)		31.2	29.2		31.2	19.1	57.4		34.2	32.2	
Actuated g/C Ratio		0.31	0.29		0.31	0.19	0.57		0.34	0.32	
v/c Ratio		1.21	0.69		0.49	1.12	0.45		0.88	0.44	
Control Delay		149.2	21.0		34.1	124.6	15.4		52.4	5.9	
Queue Delay		0.0	0.0		0.0	0.0	0.0		0.0	0.0	
Total Delay		149.2	21.0		34.1	124.6	15.4		52.4	5.9	
LOS		F	C		C	F	B		D	A	
Approach Delay		83.8			34.1		63.5		33.4		
Approach LOS		F			C		E		C		

Intersection Summary

Cycle Length: 120
 Actuated Cycle Length: 100.4
 Natural Cycle: 150
 Control Type: Actuated-Uncoordinated
 Maximum v/c Ratio: 1.21
 Intersection Signal Delay: 59.6
 Intersection Capacity Utilization 83.8%
 Analysis Period (min) 15
 Intersection LOS: E
 ICU Level of Service E

Splits and Phases: 1: Islington Street & Bartlett Street/Pharmacy Driveway

	Ø4	
61 s	35 s	24 s
Ø6		Ø8
38 s	23 s	35 s

Queues

1: Islington Street & Bartlett Street/Pharmacy Driveway



Lane Group	EBT	EBR	WBT	NBL	NBT	SBT	SBR
Lane Group Flow (vph)	426	444	154	381	483	461	319
v/c Ratio	1.21	0.69	0.49	1.12	0.45	0.88	0.44
Control Delay	149.2	21.0	34.1	124.6	15.4	52.4	5.9
Queue Delay	0.0	0.0	0.0	0.0	0.0	0.0	0.0
Total Delay	149.2	21.0	34.1	124.6	15.4	52.4	5.9
Queue Length 50th (ft)	~310	101	68	~261	148	257	3
Queue Length 95th (ft)	#639	276	105	#559	342	#585	75
Internal Link Dist (ft)	144		182		325	372	
Turn Bay Length (ft)		125		150			
Base Capacity (vph)	353	640	312	340	1067	522	729
Starvation Cap Reductn	0	0	0	0	0	0	0
Spillback Cap Reductn	0	0	0	0	0	0	0
Storage Cap Reductn	0	0	0	0	0	0	0
Reduced v/c Ratio	1.21	0.69	0.49	1.12	0.45	0.88	0.44

Intersection Summary

- ~ Volume exceeds capacity, queue is theoretically infinite.
Queue shown is maximum after two cycles.
- # 95th percentile volume exceeds capacity, queue may be longer.
Queue shown is maximum after two cycles.

HCM Signalized Intersection Capacity Analysis

1: Islington Street & Bartlett Street/Pharmacy Driveway



Movement	EBL	EBT	EBR	WBL	WBT	WBR	NBL	NBT	NBR	SBL	SBT	SBR
Lane Configurations		↔	↔	↔	↔	↔	↔	↔	↔	↔	↔	↔
Traffic Volume (vph)	335	38	392	27	45	21	320	377	25	35	344	268
Future Volume (vph)	335	38	392	27	45	21	320	377	25	35	344	268
Ideal Flow (vphpl)	1900	1900	1900	1900	1900	1900	1900	1900	1900	1900	1900	1900
Total Lost time (s)		4.0	6.0		4.0		4.0	4.0			4.0	6.0
Lane Util. Factor		1.00	1.00		1.00		1.00	1.00			1.00	1.00
Frt		1.00	0.85		0.97		1.00	0.99			1.00	0.85
Flt Protected		0.96	1.00		0.99		0.95	1.00			1.00	1.00
Satd. Flow (prot)		1802	1599		1816		1787	1865			1874	1615
Flt Permitted		0.62	1.00		0.62		0.95	1.00			0.84	1.00
Satd. Flow (perm)		1162	1599		1139		1787	1865			1583	1615
Peak-hour factor, PHF	0.95	0.95	0.95	0.63	0.63	0.63	0.89	0.89	0.89	0.90	0.90	0.90
Adj. Flow (vph)	353	40	413	43	71	33	360	424	28	39	382	298
RTOR Reduction (vph)	0	0	178	0	8	0	0	2	0	0	0	208
Lane Group Flow (vph)	0	393	235	0	139	0	360	450	0	0	421	90
Heavy Vehicles (%)	1%	0%	1%	0%	0%	0%	1%	1%	0%	0%	1%	0%
Turn Type	custom	NA	custom	custom	NA		Prot	NA		custom	NA	custom
Protected Phases							5	2				
Permitted Phases	4	4	4	8	8			2		6	6	6
Actuated Green, G (s)		30.2	30.2		30.2		17.2	54.4			31.2	31.2
Effective Green, g (s)		32.2	30.2		32.2		19.2	56.4			33.2	31.2
Actuated g/C Ratio		0.31	0.29		0.31		0.19	0.55			0.32	0.30
Clearance Time (s)		6.0	6.0		6.0		6.0	6.0			6.0	6.0
Vehicle Extension (s)		3.0	3.0		3.0		3.0	3.0			3.0	3.0
Lane Grp Cap (vph)		363	469		356		333	1023			511	490
v/s Ratio Prot							c0.20	0.24				
v/s Ratio Perm		c0.34	0.15		0.12						c0.27	0.06
v/c Ratio		1.08	0.50		0.39		1.08	0.44			0.82	0.18
Uniform Delay, d1		35.3	30.1		27.6		41.8	13.8			32.1	26.4
Progression Factor		1.00	1.00		1.00		1.00	1.00			1.00	1.00
Incremental Delay, d2		71.1	0.8		0.7		72.7	0.3			10.4	0.2
Delay (s)		106.4	30.9		28.3		114.5	14.1			42.5	26.6
Level of Service		F	C		C		F	B			D	C
Approach Delay (s)		67.7			28.3			58.6			35.9	
Approach LOS		E			C			E			D	

Intersection Summary

HCM 2000 Control Delay	53.2	HCM 2000 Level of Service	D
HCM 2000 Volume to Capacity ratio	0.99		
Actuated Cycle Length (s)	102.8	Sum of lost time (s)	19.0
Intersection Capacity Utilization	78.6%	ICU Level of Service	D
Analysis Period (min)	15		
c Critical Lane Group			

Timings

1: Islington Street & Bartlett Street/Pharmacy Driveway

											Ø9
Lane Group	EBL	EBT	EBR	WBL	WBT	NBL	NBT	SBL	SBT	SBR	Ø9
Lane Configurations											
Traffic Volume (vph)	335	38	392	27	45	320	377	35	344	268	
Future Volume (vph)	335	38	392	27	45	320	377	35	344	268	
Turn Type	custom	NA	custom	custom	NA	Prot	NA	custom	NA	custom	
Protected Phases						5	2				9
Permitted Phases	4	4	4	8	8		2	6	6	6	
Detector Phase	4	4	4	8	8	5	2	6	6	6	
Switch Phase											
Minimum Initial (s)	5.0	5.0	5.0	5.0	5.0	5.0	10.0	10.0	10.0	10.0	7.0
Minimum Split (s)	11.0	11.0	11.0	11.0	11.0	16.0	16.0	16.0	16.0	16.0	24.0
Total Split (s)	36.0	36.0	36.0	36.0	36.0	23.0	60.0	37.0	37.0	37.0	24.0
Total Split (%)	30.0%	30.0%	30.0%	30.0%	30.0%	19.2%	50.0%	30.8%	30.8%	30.8%	20%
Yellow Time (s)	4.0	4.0	4.0	4.0	4.0	4.0	4.0	4.0	4.0	4.0	3.0
All-Red Time (s)	2.0	2.0	2.0	2.0	2.0	2.0	2.0	2.0	2.0	2.0	0.0
Lost Time Adjust (s)		-2.0	0.0		-2.0	-2.0	-2.0		-2.0	0.0	
Total Lost Time (s)		4.0	6.0		4.0	4.0	4.0		4.0	6.0	
Lead/Lag						Lag		Lead	Lead	Lead	
Lead-Lag Optimize?											
Recall Mode	None	None	None	None	None	None	Min	Min	Min	Min	None
Act Effct Green (s)		32.2	30.2		32.2	19.1	56.4		33.2	31.2	
Actuated g/C Ratio		0.32	0.30		0.32	0.19	0.56		0.33	0.31	
v/c Ratio		1.05	0.63		0.39	1.06	0.43		0.80	0.42	
Control Delay		96.8	17.0		29.8	106.0	15.5		45.1	5.6	
Queue Delay		0.0	0.0		0.0	0.0	0.0		0.0	0.0	
Total Delay		96.8	17.0		29.8	106.0	15.5		45.1	5.6	
LOS		F	B		C	F	B		D	A	
Approach Delay		55.9			29.8		55.6		28.8		
Approach LOS		E			C		E		C		

Intersection Summary

Cycle Length: 120

Actuated Cycle Length: 100.4

Natural Cycle: 140

Control Type: Actuated-Uncoordinated

Maximum v/c Ratio: 1.06

Intersection Signal Delay: 46.4

Intersection LOS: D

Intersection Capacity Utilization 78.6%

ICU Level of Service D

Analysis Period (min) 15

Splits and Phases: 1: Islington Street & Bartlett Street/Pharmacy Driveway

60 s	36 s	24 s
37 s	23 s	36 s

Queues

1: Islington Street & Bartlett Street/Pharmacy Driveway



Lane Group	EBT	EBR	WBT	NBL	NBT	SBT	SBR
Lane Group Flow (vph)	393	413	147	360	452	421	298
v/c Ratio	1.05	0.63	0.39	1.06	0.43	0.80	0.42
Control Delay	96.8	17.0	29.8	106.0	15.5	45.1	5.6
Queue Delay	0.0	0.0	0.0	0.0	0.0	0.0	0.0
Total Delay	96.8	17.0	29.8	106.0	15.5	45.1	5.6
Queue Length 50th (ft)	~245	76	62	~227	139	227	0
Queue Length 95th (ft)	#568	230	97	#521	320	#514	68
Internal Link Dist (ft)	144		182		325	372	
Turn Bay Length (ft)		125		150			
Base Capacity (vph)	373	656	373	340	1049	524	707
Starvation Cap Reductn	0	0	0	0	0	0	0
Spillback Cap Reductn	0	0	0	0	0	0	0
Storage Cap Reductn	0	0	0	0	0	0	0
Reduced v/c Ratio	1.05	0.63	0.39	1.06	0.43	0.80	0.42

Intersection Summary

- ~ Volume exceeds capacity, queue is theoretically infinite.
Queue shown is maximum after two cycles.
- # 95th percentile volume exceeds capacity, queue may be longer.
Queue shown is maximum after two cycles.

HCM Signalized Intersection Capacity Analysis

1: Islington Street & Bartlett Street/Pharmacy Driveway

Movement	EBL	EBT	EBR	WBL	WBT	WBR	NBL	NBT	NBR	SBL	SBT	SBR
Lane Configurations												
Traffic Volume (vph)	370	40	428	28	47	22	347	404	26	37	378	295
Future Volume (vph)	370	40	428	28	47	22	347	404	26	37	378	295
Ideal Flow (vphpl)	1900	1900	1900	1900	1900	1900	1900	1900	1900	1900	1900	1900
Total Lost time (s)		4.0	6.0		4.0		4.0	4.0			4.0	6.0
Lane Util. Factor		1.00	1.00		1.00		1.00	1.00			1.00	1.00
Frt		1.00	0.85		0.97		1.00	0.99			1.00	0.85
Flt Protected		0.96	1.00		0.99		0.95	1.00			1.00	1.00
Satd. Flow (prot)		1802	1599		1816		1787	1865			1875	1615
Flt Permitted		0.60	1.00		0.52		0.95	1.00			0.81	1.00
Satd. Flow (perm)		1137	1599		965		1787	1865			1532	1615
Peak-hour factor, PHF	0.95	0.95	0.95	0.63	0.63	0.63	0.89	0.89	0.89	0.90	0.90	0.90
Adj. Flow (vph)	389	42	451	44	75	35	390	454	29	41	420	328
RTOR Reduction (vph)	0	0	178	0	8	0	0	2	0	0	0	220
Lane Group Flow (vph)	0	431	273	0	146	0	390	481	0	0	461	108
Heavy Vehicles (%)	1%	0%	1%	0%	0%	0%	1%	1%	0%	0%	1%	0%
Turn Type	custom	NA	custom	custom	NA		Prot	NA		custom	NA	custom
Protected Phases							5	2				
Permitted Phases	4	4	4	8	8			2		6	6	6
Actuated Green, G (s)		29.2	29.2		29.2		17.2	55.4			32.2	32.2
Effective Green, g (s)		31.2	29.2		31.2		19.2	57.4			34.2	32.2
Actuated g/C Ratio		0.30	0.28		0.30		0.19	0.56			0.33	0.31
Clearance Time (s)		6.0	6.0		6.0		6.0	6.0			6.0	6.0
Vehicle Extension (s)		3.0	3.0		3.0		3.0	3.0			3.0	3.0
Lane Grp Cap (vph)		345	454		292		333	1041			509	505
v/s Ratio Prot							c0.22	0.26				
v/s Ratio Perm		c0.38	0.17		0.15						c0.30	0.07
v/c Ratio		1.25	0.60		0.50		1.17	0.46			0.91	0.21
Uniform Delay, d1		35.8	31.8		29.4		41.8	13.5			32.8	26.0
Progression Factor		1.00	1.00		1.00		1.00	1.00			1.00	1.00
Incremental Delay, d2		134.1	2.3		1.3		104.3	0.3			19.5	0.2
Delay (s)		169.9	34.0		30.7		146.1	13.8			52.3	26.2
Level of Service		F	C		C		F	B			D	C
Approach Delay (s)		100.4			30.7			72.9			41.4	
Approach LOS		F			C			E			D	

Intersection Summary

HCM 2000 Control Delay	70.3	HCM 2000 Level of Service	E
HCM 2000 Volume to Capacity ratio	1.10		
Actuated Cycle Length (s)	102.8	Sum of lost time (s)	19.0
Intersection Capacity Utilization	84.0%	ICU Level of Service	E
Analysis Period (min)	15		
c Critical Lane Group			

Timings

1: Islington Street & Bartlett Street/Pharmacy Driveway

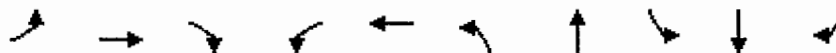

Lane Group	EBL	EBT	EBR	WBL	WBT	NBL	NBT	SBL	SBT	SBR	Ø9
Lane Configurations		↕	↗		↕	↖	↖		↕	↗	
Traffic Volume (vph)	370	40	428	28	47	347	404	37	378	295	
Future Volume (vph)	370	40	428	28	47	347	404	37	378	295	
Turn Type	custom	NA	custom	custom	NA	Prot	NA	custom	NA	custom	
Protected Phases						5	2				9
Permitted Phases	4	4	4	8	8		2	6	6	6	
Detector Phase	4	4	4	8	8	5	2	6	6	6	
Switch Phase											
Minimum Initial (s)	5.0	5.0	5.0	5.0	5.0	5.0	10.0	10.0	10.0	10.0	7.0
Minimum Split (s)	11.0	11.0	11.0	11.0	11.0	16.0	16.0	16.0	16.0	16.0	24.0
Total Split (s)	35.0	35.0	35.0	35.0	35.0	23.0	61.0	38.0	38.0	38.0	24.0
Total Split (%)	29.2%	29.2%	29.2%	29.2%	29.2%	19.2%	50.8%	31.7%	31.7%	31.7%	20%
Yellow Time (s)	4.0	4.0	4.0	4.0	4.0	4.0	4.0	4.0	4.0	4.0	3.0
All-Red Time (s)	2.0	2.0	2.0	2.0	2.0	2.0	2.0	2.0	2.0	2.0	0.0
Lost Time Adjust (s)		-2.0	0.0		-2.0	-2.0	-2.0		-2.0	0.0	
Total Lost Time (s)		4.0	6.0		4.0	4.0	4.0		4.0	6.0	
Lead/Lag						Lag		Lead	Lead	Lead	
Lead-Lag Optimize?											
Recall Mode	None	None	None	None	None	None	Min	Min	Min	Min	None
Act Effct Green (s)		31.2	29.2		31.2	19.1	57.4		34.2	32.2	
Actuated g/C Ratio		0.31	0.29		0.31	0.19	0.57		0.34	0.32	
v/c Ratio		1.22	0.70		0.50	1.15	0.45		0.88	0.45	
Control Delay		154.5	21.5		34.5	133.4	15.4		52.4	5.9	
Queue Delay		0.0	0.0		0.0	0.0	0.0		0.0	0.0	
Total Delay		154.5	21.5		34.5	133.4	15.4		52.4	5.9	
LOS		F	C		C	F	B		D	A	
Approach Delay		86.5			34.5		68.1		33.0		
Approach LOS		F			C		E		C		

Intersection Summary

Cycle Length: 120

Actuated Cycle Length: 100.4

Natural Cycle: 150

Control Type: Actuated-Uncoordinated

Maximum v/c Ratio: 1.22

Intersection Signal Delay: 62.0

Intersection Capacity Utilization 84.0%

Analysis Period (min) 15

Intersection LOS: E

ICU Level of Service E

Splits and Phases: 1: Islington Street & Bartlett Street/Pharmacy Driveway

↑ Ø2		Ø4	↖ Ø9
61 s		35 s	24 s
Ø6	↖ Ø5	Ø8	
58 s	25 s	35 s	

Queues

1: Islington Street & Bartlett Street/Pharmacy Driveway



Lane Group	EBT	EBR	WBT	NBL	NBT	SBT	SBR
Lane Group Flow (vph)	431	451	154	390	483	461	328
v/c Ratio	1.22	0.70	0.50	1.15	0.45	0.88	0.45
Control Delay	154.5	21.5	34.5	133.4	15.4	52.4	5.9
Queue Delay	0.0	0.0	0.0	0.0	0.0	0.0	0.0
Total Delay	154.5	21.5	34.5	133.4	15.4	52.4	5.9
Queue Length 50th (ft)	~316	106	69	~273	148	257	3
Queue Length 95th (ft)	#647	284	106	#574	342	#585	77
Internal Link Dist (ft)	144		182		325	372	
Turn Bay Length (ft)		125		150			
Base Capacity (vph)	353	641	308	340	1067	522	735
Starvation Cap Reductn	0	0	0	0	0	0	0
Spillback Cap Reductn	0	0	0	0	0	0	0
Storage Cap Reductn	0	0	0	0	0	0	0
Reduced v/c Ratio	1.22	0.70	0.50	1.15	0.45	0.88	0.45

Intersection Summary

- ~ Volume exceeds capacity, queue is theoretically infinite.
Queue shown is maximum after two cycles.
- # 95th percentile volume exceeds capacity, queue may be longer.
Queue shown is maximum after two cycles.

Appendix I

Auxiliary Turn Lane Warrants



Figure 2 - 5. Guideline for determining the need for a major-road left-turn bay at a two-way stop-controlled intersection.

2-lane roadway (English)

INPUT

Variable	Value
85 th percentile speed, mph:	20
Percent of left-turns in advancing volume (V_A), %:	9%
Advancing volume (V_A), veh/h:	516
Opposing volume (V_O), veh/h:	408

OUTPUT

Variable	Value
Limiting advancing volume (V_A), veh/h:	461
Guidance for determining the need for a major-road left-turn bay:	
Left-turn treatment warranted.	

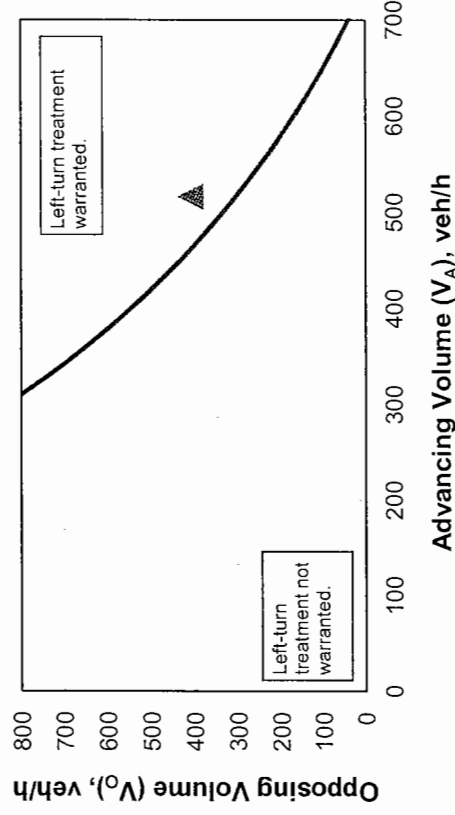

CALIBRATION CONSTANTS

Variable	Value
Average time for making left-turn, s:	3.0
Critical headway, s:	5.0
Average time for left-turn vehicle to clear the advancing lane, s:	1.9

Figure 2 - 5. Guideline for determining the need for a major-road left-turn bay at a two-way stop-controlled intersection.

2-lane roadway (English)

INPUT

Variable	Value
85 th percentile speed, mph:	20
Percent of left-turns in advancing volume (V_A), %:	4%
Advancing volume (V_A), veh/h:	679
Opposing volume (V_O), veh/h:	532

OUTPUT

Variable	Value
Limiting advancing volume (V_A), veh/h:	638
Guidance for determining the need for a major-road left-turn bay:	
Left-turn treatment warranted.	

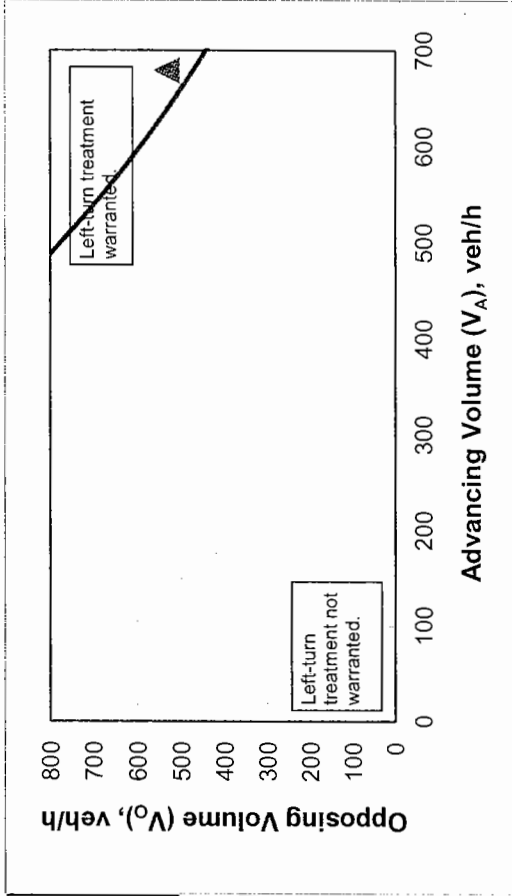

CALIBRATION CONSTANTS

Variable	Value
Average time for making left-turn, s:	3.0
Critical headway, s:	5.0
Average time for left-turn vehicle to clear the advancing lane, s:	1.9

Figure 2 - 5. Guideline for determining the need for a major-road left-turn bay at a two-way stop-controlled intersection.

2-lane roadway (English)

INPUT

Variable	Value
85 th percentile speed, mph:	20
Percent of left-turns in advancing volume (V_A), %:	10%
Advancing volume (V_A), veh/h:	521
Opposing volume (V_O), veh/h:	474

OUTPUT

Variable	Value
Limiting advancing volume (V_A), veh/h:	440

Guidance for determining the need for a major-road left-turn bay:
 Left-turn treatment warranted.

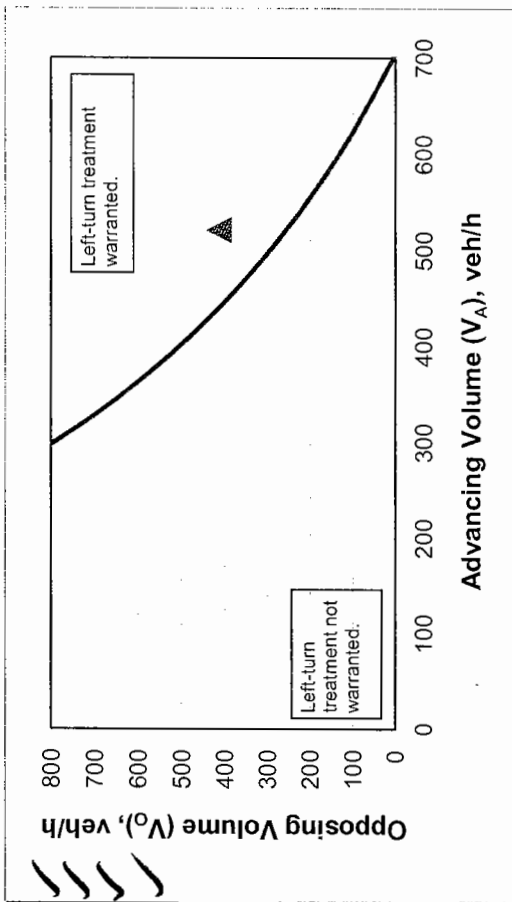

CALIBRATION CONSTANTS

Variable	Value
Average time for making left-turn, s:	3.0
Critical headway, s:	5.0
Average time for left-turn vehicle to clear the advancing lane, s:	1.9

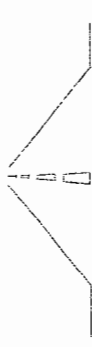

Figure 2 - 5. Guideline for determining the need for a major-road left-turn bay at a two-way stop-controlled intersection.

2-lane roadway (English)

INPUT

Variable	Value
85 th percentile speed, mph:	20
Percent of left-turns in advancing volume (V_A), %:	6%
Advancing volume (V_A), veh/h:	695
Opposing volume (V_O), veh/h:	548

OUTPUT

Variable	Value
Limiting advancing volume (V_A), veh/h:	496
Guidance for determining the need for a major-road left-turn bay:	
Left-turn treatment warranted.	

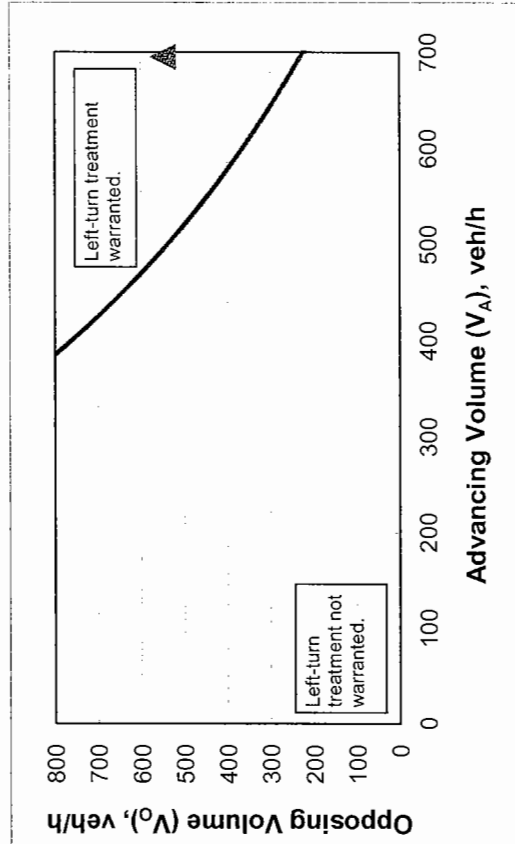

CALIBRATION CONSTANTS

Variable	Value
Average time for making left-turn, s:	3.0
Critical headway, s:	5.0
Average time for left-turn vehicle to clear the advancing lane, s:	1.9

Figure 2 - 5. Guideline for determining the need for a major-road left-turn bay at a two-way stop-controlled intersection.

2-lane roadway (English)

INPUT

Variable	Value
85 th percentile speed, mph:	20
Percent of left-turns in advancing volume (V_A), %:	26%
Advancing volume (V_A), veh/h:	538
Opposing volume (V_O), veh/h:	529

OUTPUT

Variable	Value
Limiting advancing volume (V_A), veh/h:	271
Guidance for determining the need for a major-road left-turn bay:	
Left-turn treatment warranted.	

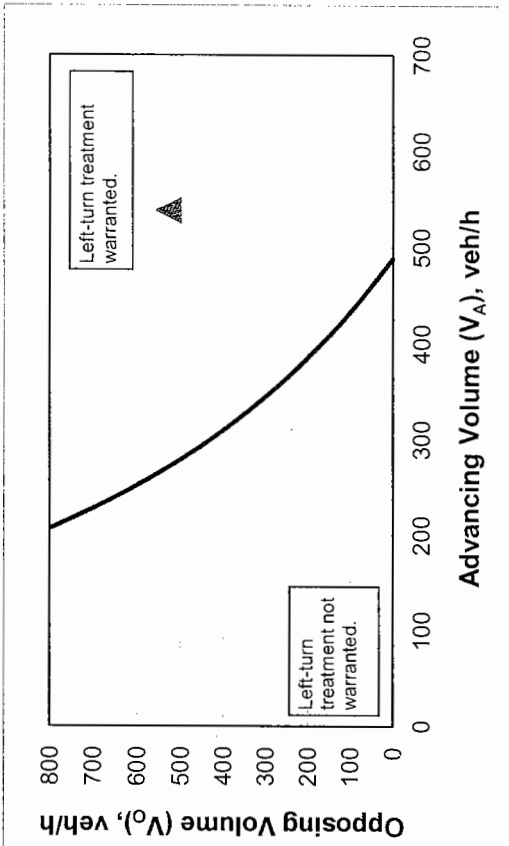

CALIBRATION CONSTANTS

Variable	Value
Average time for making left-turn, s:	3.0
Critical headway, s:	5.0
Average time for left-turn vehicle to clear the advancing lane, s:	1.9

Figure 2 - 5. Guideline for determining the need for a major-road left-turn bay at a two-way stop-controlled intersection.

2-lane roadway (English)

INPUT

Variable	Value
85 th percentile speed, mph:	20
Percent of left-turns in advancing volume (V_A), %:	18%
Advancing volume (V_A), veh/h:	648
Opposing volume (V_O), veh/h:	679

OUTPUT

Variable	Value
Limiting advancing volume (V_A), veh/h:	265
Guidance for determining the need for a major-road left-turn bay:	
Left-turn treatment warranted.	

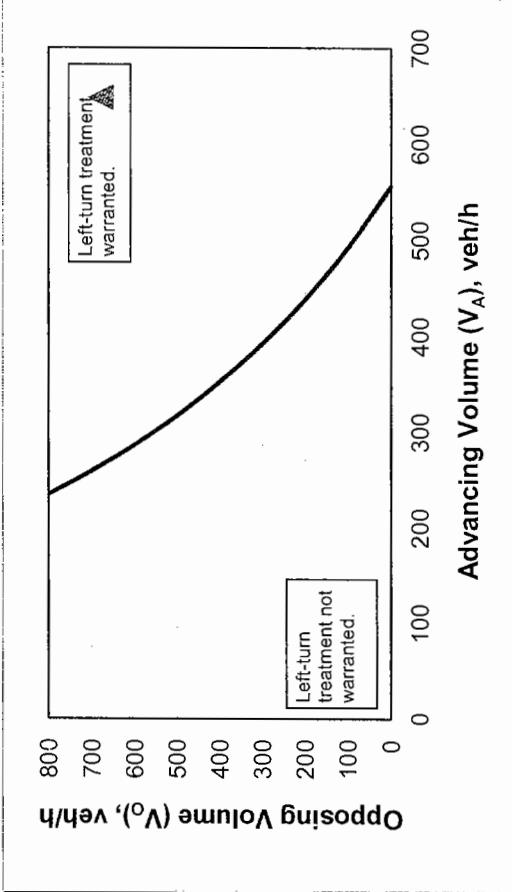

CALIBRATION CONSTANTS

Variable	Value
Average time for making left-turn, s:	3.0
Critical headway, s:	5.0
Average time for left-turn vehicle to clear the advancing lane, s:	1.9

Figure 2 - 5. Guideline for determining the need for a major-road left-turn bay at a two-way stop-controlled intersection.

2-lane roadway (English)

INPUT

Variable	Value
85 th percentile speed, mph:	20
Percent of left-turns in advancing volume (V_A), %:	25%
Advancing volume (V_A), veh/h:	544
Opposing volume (V_O), veh/h:	544

OUTPUT

Variable	Value
Limiting advancing volume (V_A), veh/h:	267
Guidance for determining the need for a major-road left-turn bay:	
Left-turn treatment warranted.	

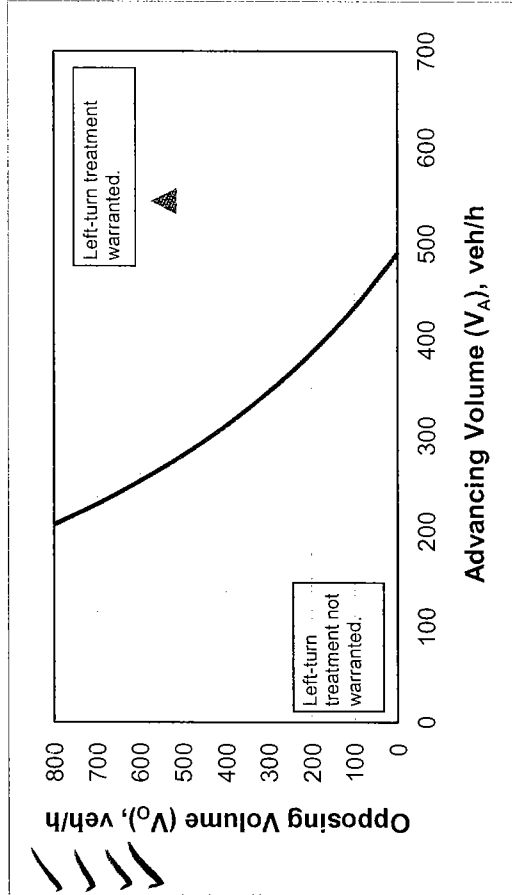

CALIBRATION CONSTANTS

Variable	Value
Average time for making left-turn, s:	3.0
Critical headway, s:	5.0
Average time for left-turn vehicle to clear the advancing lane, s:	1.9

Figure 2 - 5. Guideline for determining the need for a major-road left-turn bay at a two-way stop-controlled intersection.

2-lane roadway (English)

INPUT

Variable	Value
85 th percentile speed, mph:	20
Percent of left-turns in advancing volume (V_A), %:	18%
Advancing volume (V_A), veh/h:	664
Opposing volume (V_O), veh/h:	690

OUTPUT

Variable	Value
Limiting advancing volume (V_A), veh/h:	264
Guidance for determining the need for a major-road left-turn bay: Left-turn treatment warranted.	

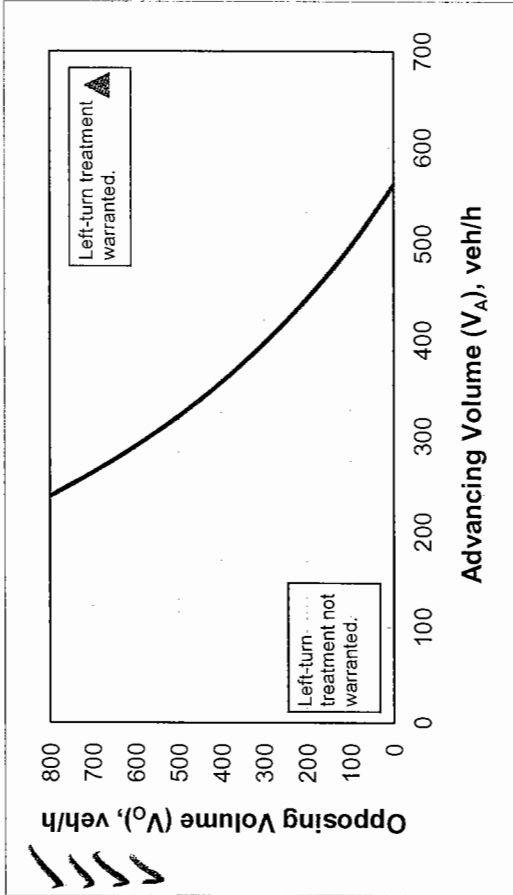

CALIBRATION CONSTANTS

Variable	Value
Average time for making left-turn, s:	3.0
Critical headway, s:	5.0
Average time for left-turn vehicle to clear the advancing lane, s:	1.9

Figure 2 - 6. Guideline for determining the need for a major-road right-turn bay at a two-way stop-controlled intersection.

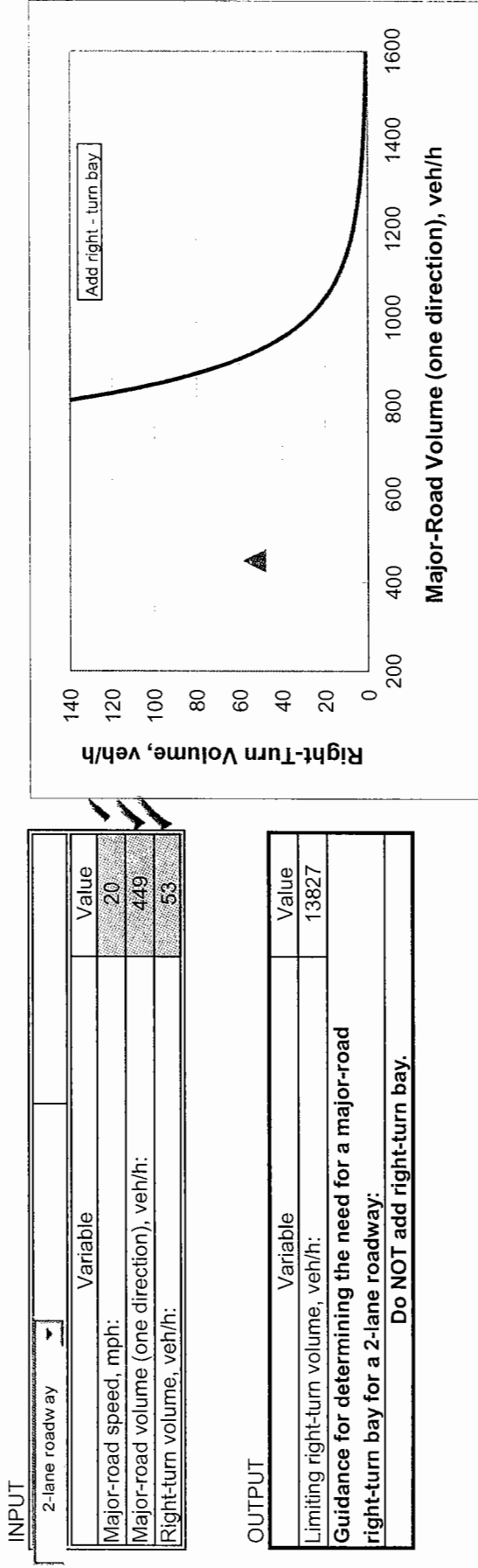

Figure 2 - 6. Guideline for determining the need for a major-road right-turn bay at a two-way stop-controlled intersection.

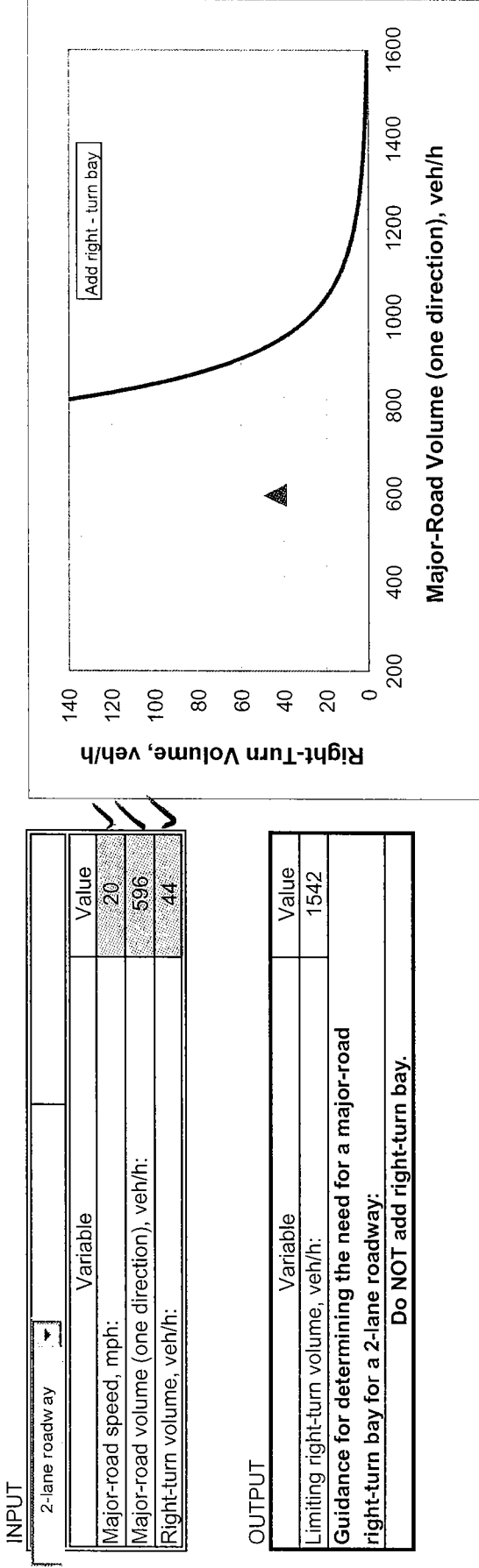

Figure 2 - 6. Guideline for determining the need for a major-road right-turn bay at a two-way stop-controlled intersection.

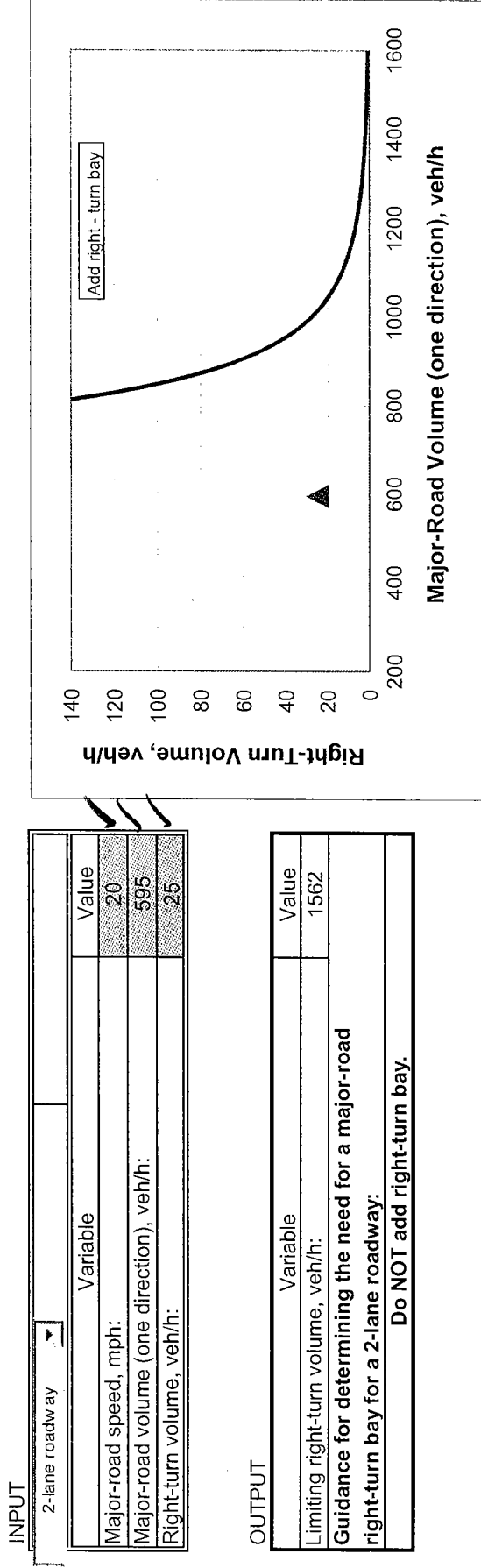

Figure 2 - 6. Guideline for determining the need for a major-road right-turn bay at a two-way stop-controlled intersection.

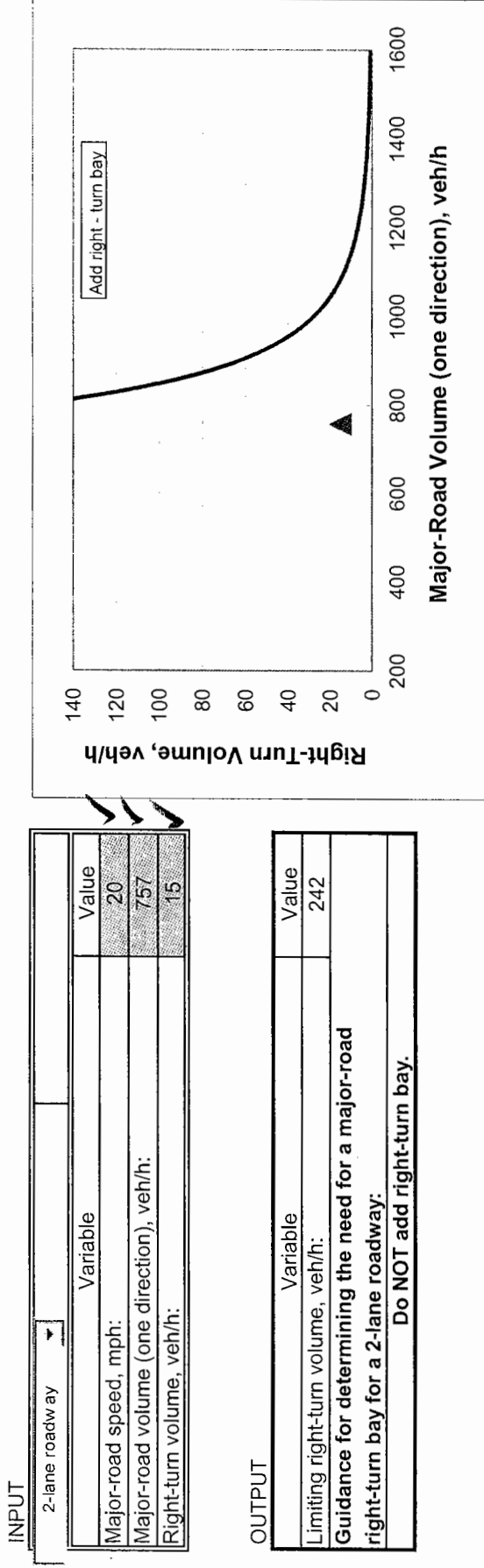

Figure 2 - 4. Guideline for determining minor-road approach geometry at two-way stop-controlled intersections.

INPUT

Variable	Value
Major-road volume (total of both directions), veh/h:	1015
Percentage of right-turns on minor road, %:	48%
Minor-road volume (one direction), veh/h:	101

OUTPUT

Variable	Value
Limiting minor-road volume (one direction), veh/h:	196
Guidance for determining minor-road approach geometry:	
ONE approach lane is o.k.	

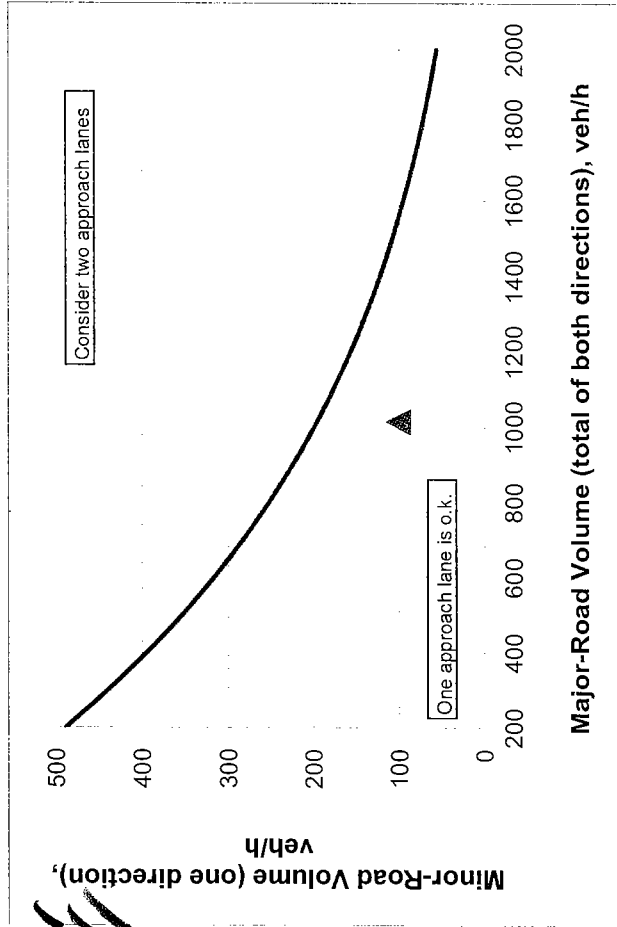

CALIBRATION CONSTANTS

Minor Road	Critical gap, s:	Follow-up gap, s:
Right-turn capacity, veh/h:	6.2	3.3
Left-turn and through capacity, veh/h:	6.5	4.0

* according to Table 17 - 5 of the HCM

Figure 2 - 4. Guideline for determining minor-road approach geometry at two-way stop-controlled intersections.

INPUT

Variable	Value
Major-road volume (total of both directions), veh/h:	1756
Percentage of right-turns on minor road, %:	65%
Minor-road volume (one direction), veh/h:	89

OUTPUT

Variable	Value
Limiting minor-road volume (one direction), veh/h:	101
Guidance for determining minor-road approach geometry:	
ONE approach lane is o.k.	

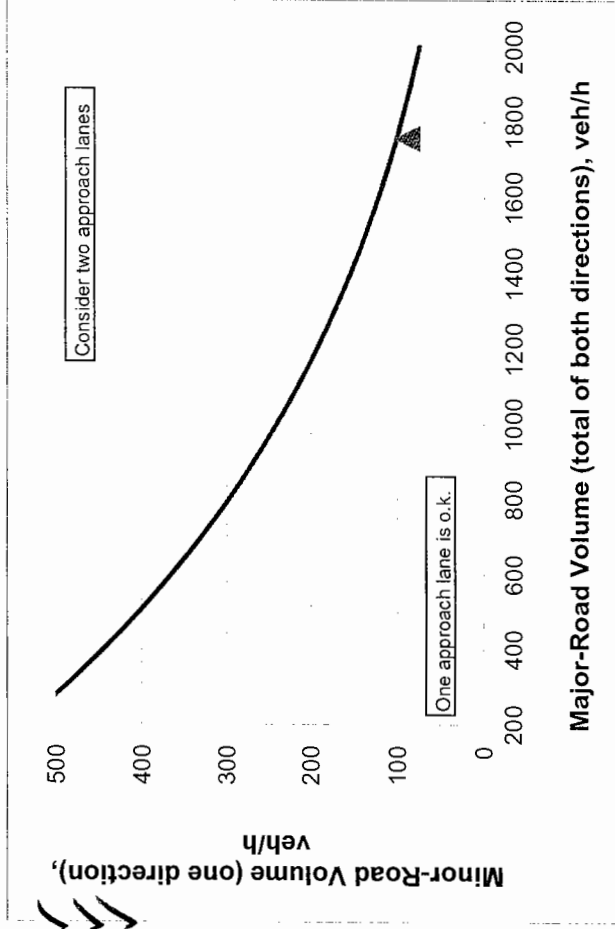

CALIBRATION CONSTANTS

Minor Road	Critical gap, s:	Follow-up gap, s:
Right-turn capacity, veh/h:	6.2	3.3
Left-turn and through capacity, veh/h:	6.5	4.0

* according to Table 17 - 5 of the HCM

Figure 2 - 4. Guideline for determining minor-road approach geometry at two-way stop-controlled intersections.

INPUT

Variable	Value
Major-road volume (total of both directions), veh/h:	1190
Percentage of right-turns on minor road, %:	97%
Minor-road volume (one direction), veh/h:	64

OUTPUT

Limiting minor-road volume (one direction), veh/h:	331
Guidance for determining minor-road approach geometry:	
ONE approach lane is o.k.	

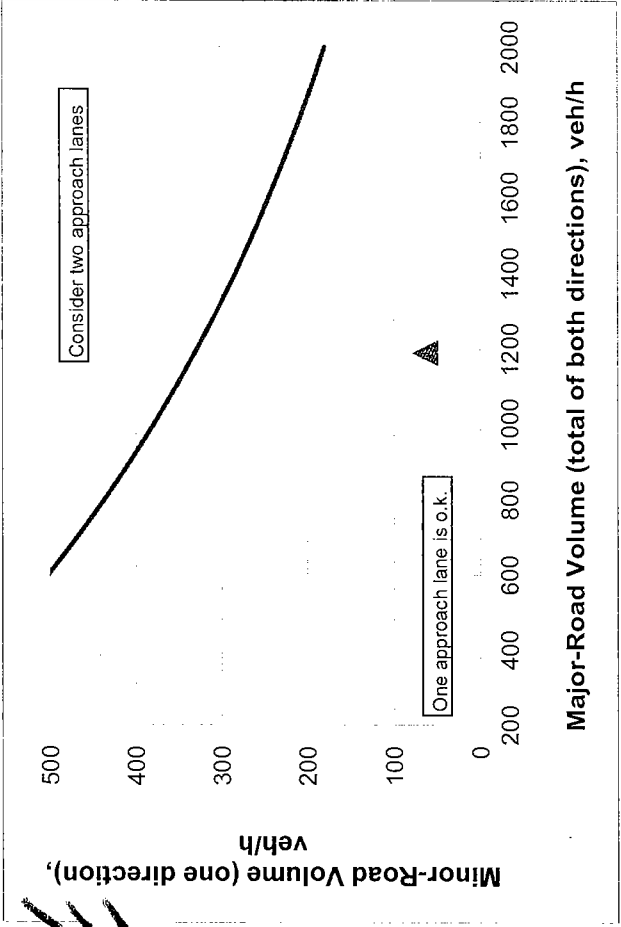

CALIBRATION CONSTANTS

Minor Road	Critical gap, s:	Follow-up gap, s:
Right-turn capacity, veh/h:	6.2	3.3
Left-turn and through capacity, veh/h:	6.5	4.0

* according to Table 17 - 5 of the HCM

Figure 2 - 4. Guideline for determining minor-road approach geometry at two-way stop-controlled intersections.

INPUT

Variable	Value
Major-road volume (total of both directions), veh/h:	1481
Percentage of right-turns on minor road, %:	97%
Minor-road volume (one direction), veh/h:	114

OUTPUT

Variable	Value
Limiting minor-road volume (one direction), veh/h:	265
Guidance for determining minor-road approach geometry:	
ONE approach lane is o.k.	

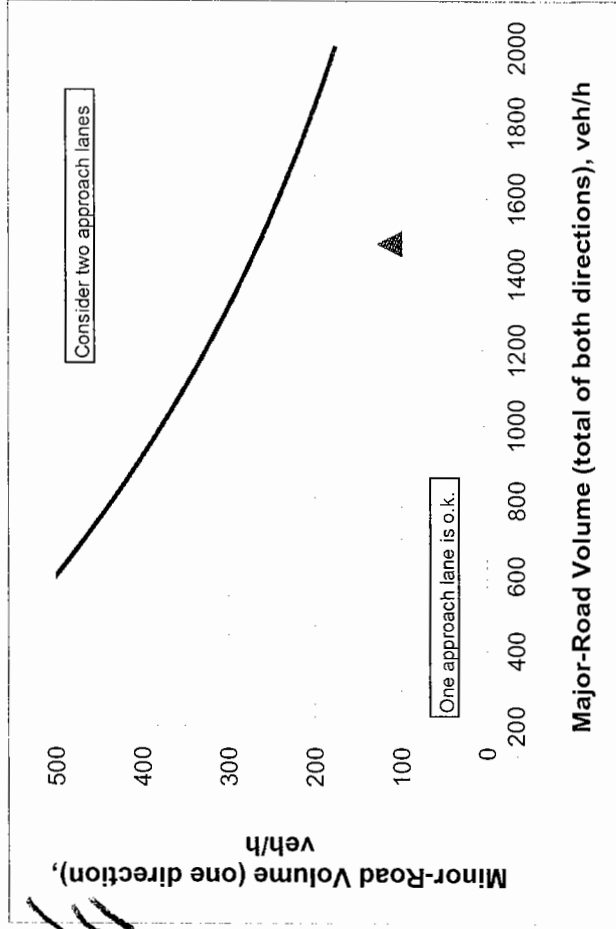

CALIBRATION CONSTANTS

Minor Road	Critical gap, s:	Follow-up gap, s:
Right-turn capacity, veh/h:	6.2	3.3
Left-turn and through capacity, veh/h:	6.5	4.0

* according to Table 17 - 5 of the HCM