



200 Griffin Road, Unit 3, Portsmouth, NH 03801
Phone (603) 430-9282 Fax 436-2315

24 January, 2024

Peter Stith, TAC Committee Chair
City of Portsmouth
1 Junkins Avenue
Portsmouth, NH 03801

RE: Submission for Conditional Use Permit and Site Plan Approval at 581 Lafayette Road; Mixed Use Development; Tax Map 229 Lot 8B

Dear Mr. Stith and TAC Members:

On behalf of Atlas Common, LLC (Owner) we submit the attached Plans and additional supporting material for the above-mentioned project. The revisions were based upon the comments from the January 2, 2024, Technical Advisory Committee meeting. The project consists of the addition of residential units (including 20% of the Units as Workforce Housing) at 581 Lafayette Road with two new building additions with the associated and required site improvements. The site is currently developed with two restaurants. The re-development will include creating an additional car park below first floor building level. The project specifics are as follows:

Project Summary

The project is located at 581 Lafayette Road and is proposed additions to an existing building. The building was renovated when the site was changed from a Cinema to the Tuscan Restaurant – Tuscan Marketplace in 2016. The site is at the corner of Lafayette Road and Ledgewood Drive, and is known as Tax Map 229, Lot 8B. The lot is a 98,124 square foot parcel with frontage on both streets. The existing conditions plan shows the current site features. The Tuscan Market moved to downtown Portsmouth, and that portion of the site was re-purposed to a restaurant with golf simulators, known as Tour. The Tuscan Marketplace closed, but recently the Tuscan Marketplace was converted to another restaurant with some outside seating.

The property is in the Gateway Neighborhood Mixed-Use District - G1. The purpose of the district is to support the goals of the cities Master Plan and Housing Policy. The aim of the policy is to encourage walkable, mixed-use development, and continued economic vitality in the cities primary gateway areas. The district seeks to ensure that new developments complement and enhance the surroundings and provide housing stock that is suitable for changing demographics and accommodate the housing needs of the city's current and future workforce. This plan works towards that standard by adding to the existing structure and

creating a mixed-use building with 72 new dwelling units. The proposed uses; being restaurant use and dwelling units (multi-family residential) are both allowed uses in the district.

Development Site Conditional Use Permit

Under Section 10.5B41.10 Development Site Standards are allowed by Conditional Use Permit approval from the Planning Board. A development site is a development including more than one principal building or building type. As the proposed development includes more than one principal building and the proposed Public Realm improvements are proposed on a separate lot, a CUP to allow the use of the Development Site Standards is being requested for this proposed project.

Conditional Use Permit Criteria

Under Section 10.5B41.10 the following addresses how the Project warrants the granting of a Conditional Use Permit for a Development Site by satisfying the following four (4) criteria for approval in Section 10.5B43.10 of the Zoning Ordinance:

1) The development project is consistent with the Portsmouth Master Plan. **The Project is consistent with several goals identified in the Master Plan.**

Goal 1.2 is to encourage walkable mixed-use development along existing commercial corridors. The project will promote walking and bicycling by expanding the sidewalk network and connecting, through the Public Realm off-site improvement, the Lafayette Road sidewalk network to the Portsmouth High School property. The plan creates public community space and public bicycle storage spaces. The project is in close proximity to a Coast Bus Stop.

Goal 2.1 is to ensure that new development complements and enhances its surroundings. The proposed residential building additions will add residential use to the adjacent commercial development. This creates the Mixed-Use environment that the Master Plan identifies as essential to the maintenance of a vibrant neighborhood. Residential uses expand on the commercial retail and restaurant uses located in the Lafayette Plaza and surrounding parcels. The Gateway Corridor was identified as an area where residential expansion is encouraged.

(2) The development project has been designed to allow uses that are appropriate for its context and consistent with the City's planning goals and objectives for the area. **The project provides much needed housing.**

The development will be complementary to the abutting uses. The proposed use is allowed within the zone. Creating a mixed-use environment will serve to ensure the maintenance of a vibrant neighborhood. The introduction of Workforce Housing provides much needed relief to the need for affordable housing.

(3) The project includes measures to mitigate or eliminate anticipated impacts on traffic safety and circulation, demand on municipal services, stormwater runoff, natural resources, and adjacent neighborhood character. **The project does not create excess demand for city services nor change the essential character of the neighborhood.**

The Project will generate peak traffic during different times than the surrounding commercial uses on Lafayette Road. The existing large traffic volumes will mask any impacts. The drainage design will increase treatment to stormwater runoff with the use of a more advanced stormwater filtration treatment practice. The addition of residential use will be complementary to the abutting commercial uses. City infrastructure is in place to accommodate the development.

(4) The project is consistent with the purpose and intent set forth in Section 10.5B11. **The project supports the Master Plan goals in a significant way by providing affordable housing and creating a mixed-use development.**

Section 10.5B11.10 states that the purpose of Article 5B is to implement and support the goals of the City's Master Plan and Housing Policy to encourage walkable mixed-use development and continued economic vitality in the City's primary gateway areas, ensure that new development complements and enhances its surroundings, provide housing stock that is suited for changing demographics, and accommodate the housing needs of the City's current and future workforce. Section 10.5B11.20 sets forth the intent of the standards. The project meets the standards and will create a mixed-use development that will help to create a vibrant neighborhood. The introduction of Workforce Housing provides much needed relief to the need for affordable housing in an area outside of the downtown core, with easy access to abutting retail and public transportation. The project will be the other bookend from the recently approved residential development at the other end of this commercial strip.

Proposed Development

The project proposes additions that are set back 33 feet from Ledgewood Drive, 39 feet from Lafayette Road, 23 feet from the southerly abutting property line, and 39 feet from the easterly abutting property line. The proposed building additions maintain the ability for the free flow of traffic around the proposed additions, as required by deed restrictions and easements on the property. The building height is intended to comply with section 10.5 B 22.10, with incentives as allowed under the section. Regarding the special 90-foot setback requirement on Lafayette Road, the project is in a location where there is a significant open space in front of the subject parcel. This open space was created when the Lafayette Road, Route 1 Bypass intersection was restructured around 2011. That relocation of the intersection created this large open space area in front of the lot, which meets the special setback requirement for this parcel.

The submitted site plan shows the impervious surface calculations for the proposed development. When the site was redeveloped to the Tuscan Marketplace, the impervious surface coverage (increase) was allowed under a Variance, up to coverage which maintained

16.5% open space. The submitted site plan proposes coverage of 82.4%, leaving an open space of 17.2% (after slight deductions), which is more than the allowable as granted by the ZBA decision of 2015. We understand that the Variance grant was for that layout, and not the proposal currently before the city. Sections 10.5B34.80 Mixed Use Building and 10.5B42.30 General Residential Development both require Minimum open space coverage of 20%. Therefore, and as allowed, as a part of this application we request that the Planning Board waive the 20% Open Space requirement for this proposal.

Project Parking

First floor parking spaces are accessed from driveways to the parking areas at first floor level, as shown on the site plan. Underground parking is accessed from a driveway ramp on the north side of the proposed structure off Ledgewood Drive. The total parking provided is within 11 spaces of meeting the ordinance requirements of the city of Portsmouth, however in this case this property has deeded agreements with the abutting properties along Lafayette Road, wherein shared parking is a deeded right among the properties. Therefore, in this case the parking provided meets the ordinance.

Existing Conditions / Pavement

The presence of parking in front of the building is as it has been for many years. A variance for parking in front of the building was granted to the Tuscan project. When this property was used as a cinema, and additionally when it was re-purposed to Tuscan Marketplace, the Existing Conditions Plans showed that some of the pavement on the Lafayette Road side of the building is partially located in the state highway right of way. Those spaces and that pavement existed when the work was done to relocate the Ledgewood Drive / Route 1 Bypass intersection, removing the old fly-over ramp. The pavement in question was allowed to remain. Attached is a copy of the NHDOT Highway plans showing the relationship between the right-of-way line and the pavement at the time of the improvement project. In addition, when the property was redeveloped into the Tuscan Marketplace, the pavement existed in that location, was shown on the plans, and was a part of the site plan approval.

Project Drainage

The existing drainage consists of some roof drain connections as well as some parking lot connections to the drainage network, which flow off-site. The property drainage is divided into two watersheds, one that flows to the south along the front of the adjacent mall and the other flows to the south along the back of the adjacent mall and across the adjacent property. The intent of this design is to maintain those flow directions and re-purpose the drainage in accordance with the proposed site addition roof drains. The roof drains will replace the catch basins and direct the water in the same direction as the previous approved design, with the same contributing area. The plan calls for the addition of a Jellyfish Filter, which will provide more advanced treatment than the existing on-site mechanical separator.

Proposed Public Realm

Under Section 10.5B74.12 the development standards of that section require that there is a Public Realm Improvement associated with the development. The project proposes an off-site sidewalk connection to Portsmouth High School, and an improved basketball facility on

city property at the end of Ledgewood Drive, as this component. The development team met with Ken Linchey and Zach McLaughlin to propose the sidewalk, trail connection, and basketball facility improvements included in the plan set. Discussions are ongoing at this time. This submission includes a DRAFT MOU that could take the form of an outright donation, or a plan and build project; two versions are submitted. Currently the Portsmouth School Facilities Department is engaging in a study of the high school access and parking lot arrangements, therefore this project may be well served by being included in the design and construction of the overall project, which is why the donation may be the preferred avenue of compliance, for the benefit of all the parties involved. The required length of sidewalk, based on the site frontage, is provided.

Project Community Space

The Community Space development standard is being met with (2) Wide Pedestrian Sidewalks and a Courtyard. The Wide Pedestrian Sidewalk 1 includes a proposed public bike rack in close proximity to a bus stop. The Courtyard provides an area of outside use for the public, as well as the building residents. The area includes an outdoor fireplace and can be set up with tables and chairs for gathering. The space dedicated to the existing restaurants for outdoor dining is not included in the Community Space Easement area. The required 10% of lot area as Community Space is provided.

TAC Committee Comments

The project team met with the Technical Advisory Committee to review the technical aspects of the project. Some items will be addressed are as follows:

- The final plans will reflect that each of the unit types will have the requisite number of full ADA Accessible Units included.
- The support for the proposed sewer line in the basement will be a typical mechanical pipe hanger system from the rafters. The details would be included in the building permit plans.

Conditional Use Permit Development Standards

We established above that the development is consistent with the Portsmouth Master Plan. The project has been designed under Article 5B Gateway Neighborhood Mixed Use Districts, Section 10.5B34.80, Mixed-Use Building and Section 10.5B42.20, Mixed-Use Development. The development standards of that section requires relief from the Planning Board for a Conditional Use Permit where development deviates from the strict standards.

In the density section of the ordinance this development would be allowed up to 24 units per structure. This project proposes a Conditional Use Permit for a density bonus as allowed in section 10.5B72 for two buildings with 36 units in each building. This increased housing density is allowed with an incentive. In order to be eligible for the bonus incentive the development shall include workforce housing. The intent of this development is to provide workforce housing as defined by the Portsmouth Ordinance in the amount of 20% of the dwelling units, or 15 units.

We believe that under section 10.5B74.30 the Planning Board is authorized to grant modifications to the standards of the section. Modifications to the required open space

requirement will be requested of the Planning Board in this application. We believe that the modifications to the strict ordinance interpretations are consistent with the purpose and intent set forth in the Gateway Neighborhood Mixed-Use District section. The site offers 17.6% open space where 20% is required.

Project Site Details

The complete development plan is shown on the attached Proposed Site Plans and the Supplemental material submitted herewith.

Requested Approval

We look forward to TAC review of this submission and the Committees feedback on the proposed design. We hereby request that the project be approved and allowed to move forward to the Planning Board.

Sincerely,

A handwritten signature in black ink, appearing to read 'J. Chagnon', with a stylized flourish extending to the right.

John Chagnon, PE; Ambit Engineering – Haley Ward

P:\NH\5010156-McNabb_Properties\1397.03-Lafayette Rd., Portsmouth-JRC\2023 Site Plan 1397.03\Applications\Portsmouth Site Plan\581 Lafayette TAC Response to Comments 1-2-23.doc



City of Portsmouth, New Hampshire

Site Plan Application Checklist

This site plan application checklist is a tool designed to assist the applicant in the planning process and for preparing the application for Planning Board review. The checklist is required to be completed and uploaded to the Site Plan application in the City's online permitting system. A pre-application conference with a member of the planning department is strongly encouraged as additional project information may be required depending on the size and scope. The applicant is cautioned that this checklist is only a guide and is not intended to be a complete list of all site plan review requirements. Please refer to the Site Plan review regulations for full details.

Applicant Responsibilities (Section 2.5.2): Applicable fees are due upon application submittal along with required attachments. The application shall be complete as submitted and provide adequate information for evaluation of the proposed site development. Waiver requests must be submitted in writing with appropriate justification.

Name of Applicant: Atlas Commons, LLC Date Submitted: 11/20/2023

Application # (in City's online permitting): TBD

Site Address: 581 Lafayette Road Map: 229 Lot: 8B

Application Requirements			
<input checked="" type="checkbox"/>	Required Items for Submittal	Item Location (e.g. Page or Plan Sheet/Note #)	Waiver Requested
<input type="checkbox"/>	Complete application form submitted via the City's web-based permitting program (2.5.2.1(2.5.2.3A))	Online	N/A
<input type="checkbox"/>	All application documents, plans, supporting documentation and other materials uploaded to the application form in viewpoint in digital Portable Document Format (PDF). One hard copy of all plans and materials shall be submitted to the Planning Department by the published deadline. (2.5.2.8)	Online	N/A

Site Plan Review Application Required Information			
<input checked="" type="checkbox"/>	Required Items for Submittal	Item Location (e.g. Page/line or Plan Sheet/Note #)	Waiver Requested
<input type="checkbox"/>	Statement that lists and describes "green" building components and systems. (2.5.3.1B)	Supplemental Materials	
<input type="checkbox"/>	Existing and proposed gross floor area and dimensions of all buildings and statement of uses and floor area for each floor. (2.5.3.1C)	Architects Plans	N/A
<input type="checkbox"/>	Tax map and lot number, and current zoning of all parcels under Site Plan Review. (2.5.3.1D)	Sheet C1	N/A

Site Plan Review Application Required Information			
<input checked="" type="checkbox"/>	Required Items for Submittal	Item Location (e.g. Page/line or Plan Sheet/Note #)	Waiver Requested
<input type="checkbox"/>	Owner's name, address, telephone number, and signature. Name, address, and telephone number of applicant if different from owner. (2.5.3.1E)	Cover Sheet	N/A
<input type="checkbox"/>	Names and addresses (including Tax Map and Lot number and zoning districts) of all direct abutting property owners (including properties located across abutting streets) and holders of existing conservation, preservation or agricultural preservation restrictions affecting the subject property. (2.5.3.1F)	Cover Sheet & Sheet C1	N/A
<input type="checkbox"/>	Names, addresses and telephone numbers of all professionals involved in the site plan design. (2.5.3.1G)	Cover Sheet	N/A
<input type="checkbox"/>	List of reference plans. (2.5.3.1H)	N/A	N/A
<input type="checkbox"/>	List of names and contact information of all public or private utilities servicing the site. (2.5.3.1I)	Cover Sheet	N/A

Site Plan Specifications			
<input checked="" type="checkbox"/>	Required Items for Submittal	Item Location (e.g. Page/line or Plan Sheet/Note #)	Waiver Requested
<input type="checkbox"/>	Full size plans shall not be larger than 22 inches by 34 inches with match lines as required, unless approved by the Planning Director.. (2.5.4.1A)	Required on all plan sheets	N/A
<input type="checkbox"/>	Scale: Not less than 1 inch = 60 feet and a graphic bar scale shall be included on all plans. (2.5.4.1B)	Required on all plan sheets	N/A
<input type="checkbox"/>	GIS data should be referenced to the coordinate system New Hampshire State Plane, NAD83 (1996), with units in feet. (2.5.4.1C)	NAD83	N/A
<input type="checkbox"/>	Plans shall be drawn to scale and stamped by a NH licensed civil engineer. (2.5.4.1D)	Required on all plan sheets	N/A
<input type="checkbox"/>	Wetlands shall be delineated by a NH certified wetlands scientist and so stamped. (2.5.4.1E)	N/A	N/A
<input type="checkbox"/>	Title (name of development project), north point, scale, legend. (2.5.4.2A)	Cover Sheet	N/A
<input type="checkbox"/>	Date plans first submitted, date and explanation of revisions. (2.5.4.2B)	Each Sheet	N/A
<input type="checkbox"/>	Individual plan sheet title that clearly describes the information that is displayed. (2.5.4.2C)	Required on all plan sheets	N/A
<input type="checkbox"/>	Source and date of data displayed on the plan. (2.5.4.2D)	Land Survey	N/A

Site Plan Specifications – Required Exhibits and Data

<input checked="" type="checkbox"/>	Required Items for Submittal	Item Location (e.g. Page/line or Plan Sheet/Note #)	Waiver Requested
<input type="checkbox"/>	<p>1. Existing Conditions: (2.5.4.3A)</p> <ul style="list-style-type: none"> • Surveyed plan of site showing existing natural and built features; • Existing building footprints and gross floor area; • Existing parking areas and number of parking spaces provided; • Zoning district boundaries; • Existing, required, and proposed dimensional zoning requirements including building and open space coverage, yards and/or setbacks, and dwelling units per acre; • Existing impervious and disturbed areas; • Limits and type of existing vegetation; • Wetland delineation, wetland function and value assessment (including vernal pools); • SFHA, 100-year flood elevation line and BFE data, as required. 	Sheet C1	
<input type="checkbox"/>	<p>2. Buildings and Structures: (2.5.4.3B)</p> <ul style="list-style-type: none"> • Plan view: Use, size, dimensions, footings, overhangs, 1st fl. elevation; • Elevations: Height, massing, placement, materials, lighting, façade treatments; • Total Floor Area; • Number of Usable Floors; • Gross floor area by floor and use. 	Sheet C3 & Architects Plans	
<input type="checkbox"/>	<p>3. Access and Circulation: (2.5.4.3C)</p> <ul style="list-style-type: none"> • Location/width of access ways within site; • Location of curbing, right of ways, edge of pavement and sidewalks; • Location, type, size and design of traffic signing (pavement markings); • Names/layout of existing abutting streets; • Driveway curb cuts for abutting prop. and public roads; • If subdivision; Names of all roads, right of way lines and easements noted; • AASHTO truck turning templates, description of minimum vehicle allowed being a WB-50 (unless otherwise approved by TAC). 	Sheet C3 & Turning Plans	
<input type="checkbox"/>	<p>4. Parking and Loading: (2.5.4.3D)</p> <ul style="list-style-type: none"> • Location of off street parking/loading areas, landscaped areas/buffers; • Parking Calculations (# required and the # provided). 	Sheet C3 & C4	
<input type="checkbox"/>	<p>5. Water Infrastructure: (2.5.4.3E)</p> <ul style="list-style-type: none"> • Size, type and location of water mains, shut-offs, hydrants & Engineering data; • Location of wells and monitoring wells (include protective radii). 	Sheet C5	
<input type="checkbox"/>	<p>6. Sewer Infrastructure: (2.5.4.3F)</p> <ul style="list-style-type: none"> • Size, type and location of sanitary sewage facilities & Engineering data, including any onsite temporary facilities during construction period. 	Sheet C5	

<input type="checkbox"/>	7. Utilities: (2.5.4.3G) <ul style="list-style-type: none"> The size, type and location of all above & below ground utilities; Size type and location of generator pads, transformers and other fixtures. 	Sheet C5	
<input type="checkbox"/>	8. Solid Waste Facilities: (2.5.4.3H) <ul style="list-style-type: none"> The size, type and location of solid waste facilities. 	Sheet C3	
<input type="checkbox"/>	9. Storm water Management: (2.5.4.3I) <ul style="list-style-type: none"> The location, elevation and layout of all storm-water drainage. The location of onsite snow storage areas and/or proposed off-site snow removal provisions. Location and containment measures for any salt storage facilities Location of proposed temporary and permanent material storage locations and distance from wetlands, water bodies, and stormwater structures. 	Sheet C6	
<input type="checkbox"/>	10. Outdoor Lighting: (2.5.4.3J) <ul style="list-style-type: none"> Type and placement of all lighting (exterior of building, parking lot and any other areas of the site) and photometric plan. 	TBD	
<input type="checkbox"/>	11. Indicate where dark sky friendly lighting measures have been implemented. (10.1)	TBD	
<input type="checkbox"/>	12. Landscaping: (2.5.4.3K) <ul style="list-style-type: none"> Identify all undisturbed area, existing vegetation and that which is to be retained; Location of any irrigation system and water source. 	Sheet L1 & L2	
<input type="checkbox"/>	13. Contours and Elevation: (2.5.4.3L) <ul style="list-style-type: none"> Existing/Proposed contours (2 foot minimum) and finished grade elevations. 	Sheet C6	
<input type="checkbox"/>	14. Open Space: (2.5.4.3M) <ul style="list-style-type: none"> Type, extent and location of all existing/proposed open space. 	Sheet C6	
<input type="checkbox"/>	15. All easements, deed restrictions and non-public rights of ways. (2.5.4.3N)	Sheet C1	
<input type="checkbox"/>	16. Character/Civic District (All following information shall be included): (2.5.4.3P) <ul style="list-style-type: none"> Applicable Building Height (10.5A21.20 & 10.5A43.30); Applicable Special Requirements (10.5A21.30); Proposed building form/type (10.5A43); Proposed community space (10.5A46). 	N/A	
<input type="checkbox"/>	17. Special Flood Hazard Areas (2.5.4.3Q) <ul style="list-style-type: none"> The proposed development is consistent with the need to minimize flood damage; All public utilities and facilities are located and construction to minimize or eliminate flood damage; Adequate drainage is provided so as to reduce exposure to flood hazards. 	N/A	

Other Required Information

<input checked="" type="checkbox"/>	Required Items for Submittal	Item Location (e.g. Page/line or Plan Sheet/Note #)	Waiver Requested
<input type="checkbox"/>	Traffic Impact Study or Trip Generation Report, as required. (3.2.1-2)	Supplemental	
<input type="checkbox"/>	Indicate where Low Impact Development Design practices have been incorporated. (7.1)	Sheet C6	
<input type="checkbox"/>	Indicate whether the proposed development is located in a wellhead protection or aquifer protection area. Such determination shall be approved by the Director of the Dept. of Public Works. (7.3.1)	N/A	
<input type="checkbox"/>	Stormwater Management and Erosion Control Plan. (7.4)	Sheet D1	
<input type="checkbox"/>	Inspection and Maintenance Plan (7.6.5)	Drainage Analysis	

Final Site Plan Approval Required Information

<input checked="" type="checkbox"/>	Required Items for Submittal	Item Location (e.g. Page/line or Plan Sheet/Note #)	Waiver Requested
<input type="checkbox"/>	All local approvals, permits, easements and licenses required, including but not limited to: <ul style="list-style-type: none"> • Waivers; • Driveway permits; • Special exceptions; • Variances granted; • Easements; • Licenses. (2.5.3.2A)	Cover Sheet	
<input type="checkbox"/>	Exhibits, data, reports or studies that may have been required as part of the approval process, including but not limited to: <ul style="list-style-type: none"> • Calculations relating to stormwater runoff; • Information on composition and quantity of water demand and wastewater generated; • Information on air, water or land pollutants to be discharged, including standards, quantity, treatment and/or controls; • Estimates of traffic generation and counts pre- and post-construction; • Estimates of noise generation; • A Stormwater Management and Erosion Control Plan; • Endangered species and archaeological / historical studies; • Wetland and water body (coastal and inland) delineations; • Environmental impact studies. (2.5.3.2B)	Supplemental Materials	
<input type="checkbox"/>	A document from each of the required private utility service providers indicating approval of the proposed site plan and indicating an ability to provide all required private utilities to the site. (2.5.3.2D)	To Be Provided	

Final Site Plan Approval Required Information

<input checked="" type="checkbox"/>	Required Items for Submittal	Item Location (e.g. Page/line or Plan Sheet/Note #)	Waiver Requested
<input type="checkbox"/>	A list of any required state and federal permit applications required for the project and the status of same. (2.5.3.2E)	Cover Sheet	
<input type="checkbox"/>	A note shall be provided on the Site Plan stating: "All conditions on this Plan shall remain in effect in perpetuity pursuant to the requirements of the Site Plan Review Regulations." (2.5.4.2E)	Sheet C3	N/A
<input type="checkbox"/>	For site plans that involve land designated as "Special Flood Hazard Areas" (SFHA) by the National Flood Insurance Program (NFIP) confirmation that all necessary permits have been received from those governmental agencies from which approval is required by Federal or State law, including Section 404 of the Federal Water Pollution Control Act Amendments of 1972, 33 U.S.C. 1334. (2.5.4.2F)	N/A	
<input type="checkbox"/>	Plan sheets submitted for recording shall include the following notes: a. "This Site Plan shall be recorded in the Rockingham County Registry of Deeds." b. "All improvements shown on this Site Plan shall be constructed and maintained in accordance with the Plan by the property owner and all future property owners. No changes shall be made to this Site Plan without the express approval of the Portsmouth Planning Director." (2.13.3)	Sheet C3	N/A

Applicant's Signature: _____



Date: 11/20/2023

Return to:
City of Portsmouth
Legal Department
1 Junkins Ave
Portsmouth, NH 03801

WORKFORCE HOUSING COVENANT

THIS LAND USE RESTRICTION COVENANT FOR WORKFORCE HOUSING ("Covenant") is made and entered into on this _____ day of _____, 2024 between the **City of Portsmouth**, a municipal corporation organized under the laws of the State of New Hampshire and having a place of business at 1 Junkins Avenue, Portsmouth, County of Rockingham, State of New Hampshire (the "City") and **Atlas Commons, LLC**, a New Hampshire limited company with an address of 3 Pleasant Street, Suite 400, Portsmouth, New Hampshire 03801 (the "Owner")(the City and the Owner are collectively the "Parties").

PREAMBLE

WHEREAS, the Owner owns a certain tract or parcel of land, together with any buildings or improvements thereon, situated at 581 Lafayette Road in the City of Portsmouth, County of Rockingham and State of New Hampshire as defined, described and identified in the Warranty Deed dated March 30, 2023, recorded in the Rockingham County Registry of Deeds ("Registry"), Book 6474, Page 1538 (the "Property"); and

WHEREAS, the Owner has obtained site plan approval of as mixed-use development (the "Project") and a conditional use permit from the City Planning Board to develop the property pursuant to correspondence from the City Planning Department dated _____ (the "Approval"); and

WHEREAS, as part of the approval process for the Project, the Owner agreed to maintain 20% of the completed residential dwellings at the Property, evenly distributed, as workforce housing units as defined herein; and

WHEREAS, the Owner further agreed to a stipulation with the Portsmouth Planning Board at the meeting on _____, to allow units that are affordable to a household with a HUD Median Family Income for the Portsmouth-Rochester Metropolitan Area program of 60% of AMI for a 3-person household to qualify as workforce housing; and

WHEREAS, this Covenant is designed to satisfy the aforementioned stipulations placed on the Approval by requiring that 20% percent of the residential dwelling Units (the “Designated Workforce Housing Units”), shall be maintained for a full term of 30 years as workforce housing for a household with an income of 60% of the median income for a 3-person housing for the Portsmouth-Rochester HUD Metropolitan Fair Market Rent; and

WHEREAS, this Covenant shall apply solely to the “Designated Workforce Housing Units” in the Project, and the Parties agree that this Covenant shall not apply to, burden or encumber the remaining dwelling units in the Project, or the tenants of those units; and

WHEREAS, this Covenant is intended to require that any tenant of the Workforce Housing Unit qualify as a Qualifying Occupant; and

WHEREAS, this Covenant shall apply to and be enforceable by the City as set forth in this Covenant; and

WHEREAS, the City or its designated agent or successor, shall have the authority to monitor and enforce this Covenant.

NOW, THEREFORE, in consideration of the mutual covenants and undertakings set forth herein, and other good and valuable consideration the receipt and sufficiency of which are hereby acknowledged, the City and the Owner do hereby contract and agree as follows:

COVENANT

Section 1. Definitions and Interpretation. In addition to the words and terms defined elsewhere in this Covenant, unless otherwise expressly provided herein or unless the context clearly requires otherwise, the following terms shall have the respective meanings set forth below for all purposes of this Covenant:

“Affordable” means that the rent shall be affordable to a Qualifying Tenant. Rent for any unit shall be set at the 60% Rent Limit for a 3-person household, determined on a per-bedroom basis, as established by the Portsmouth-Rochester HUD Metropolitan Fair Market Rent Areas as published annually by HUD.

"Annual Income Certification" means the Annual Income Certification described in Section 4(b) of this Covenant.

“Certification of Continuing Program Compliance” means the Certification of Continuing Compliance described in Section 4(d) of this Covenant and by any document required by the City or the City’s agent confirming compliance.

“Gross Rent” means net rent plus utilities, including electricity, heating and ventilation, water heating, and cooking, but shall not include telephone, television (cable or satellite) services, Wi-Fi, internet services, web-based services, or other such electronic systems or services. Calculation of utility costs may be based on the Utility Allowance Schedule for New Hampshire, published by the New Hampshire Housing Finance Authority.

"Qualifying Occupant" means any individual (a prospective tenant or present tenant of the Project) whose income is 60% or less of median income for a three (3) person household in the Portsmouth-Rochester HUD Metropolitan Fair Market Rent as published annually by HUD.

"State" means the state of New Hampshire.

"Term" or "Term of this Covenant" means the period during which this Covenant is in effect, as determined pursuant to Section 6.

“Workforce Housing” means a dwelling, or group of dwellings, developed as a single project, containing workforce housing units, provided that a housing development that excludes minor children from more than 20 percent of the units, or in which more than 50 percent of the dwelling units have fewer than two bedrooms, shall not constitute workforce housing for the purposes of this Covenant.

“Workforce Housing Unit” means a housing unit which qualifies as “workforce housing” under this Covenant, including rental housing which is Affordable to a Qualifying Tenant.

All capitalized words and terms used but not defined in this Covenant shall have the common and ordinary meaning ascribed to them unless the word or term is defined in this Covenant including any future amendments hereto to the extent applicable to the Project.

Unless the context clearly requires otherwise, words of the masculine gender shall be construed to include correlative words of the feminine and neuter genders and vice versa, and words of the singular number shall be construed to include correlative words of the plural number and vice versa. This Covenant and all the terms and provisions hereof shall be construed to effectuate the purposes set forth herein and to sustain the validity hereof.

The titles and headings of the sections of this Covenant have been inserted for convenience of reference only and are not to be considered a part hereof and shall not in any way modify or restrict any of the terms or provisions hereof and shall never be considered or given any effect in construing this Covenant or any provision hereof or in ascertaining intent if any question of intent shall arise.

Section 2. Representations, Covenants and Warranties of Owner.

(a) The Owner

(i) is a New Hampshire limited liability company duly organized under the laws of the State of New Hampshire, and is qualified to transact business under the laws of the State,

(ii) has the power and authority to own its properties and assets and to carry on its business as now being conducted and as now contemplated by this Covenant, and

(iii) has the full legal right, power and authority to execute and deliver this Covenant and to perform all the undertakings of the Owner hereunder.

(b) The execution and performance of this Covenant by the Owner

(i) will not violate or, as applicable, have not violated a provision of law, rule or regulation, or any order of any court or other agency or governmental body, and

(ii) will not violate or, as applicable, have not violated any provision of any indenture, Covenant, mortgage, mortgage note, or other instrument to which the Owner is a party or by which it or its property is bound, and

(iii) will not result in the creation or imposition of any prohibited lien, charge or encumbrance of any nature. The Owner agrees to obtain the written recordable consent of any prior lienholder to this Covenant, and to record it prior to the issuance of any building permit for this project.

Section 3. Workforce Housing. The City and the Owner hereby declare their understanding and intent that the Property will be owned, managed, and operated to always include the 20% “Designated Workforce Housing Units” during the Term of this Covenant. To that end, the Owner hereby represents, covenants, and agrees that:

(a) At least 20% of the completed dwelling units to be developed in the Project shall be Workforce Housing as defined herein. The Designated Workforce Housing Units shall be evenly distributed throughout the building.

(b) Any tenant or leasee of any Workforce Housing Unit, if any, shall also qualify as Qualifying Occupants for the Term of this Covenant.

(c) Each of the Designated Workforce Housing Units shall be both Affordable and occupied by a Qualifying Tenants.

(d) The form of lease to be utilized by the Owner in renting any Designated Workforce Housing Units in the Project to any person who is intended to be a Qualifying Tenant shall provide for termination of the lease and consent by such person to immediate eviction for failure to qualify

as a Qualifying Tenant as a result of any material misrepresentation made by such person with respect to the income certification at the time of lease or the failure by such tenant to execute an income certification annually or within 12 months of disqualifying as a Qualifying Tenant. If a Qualifying Tenant exceeds the income requirements because of an improved financial condition, that tenant shall be entitled to ninety (90) day notice of eviction but shall be responsible for complying with all terms of this Covenant and the Tenant's lease after the notice of eviction is served.

(e) Owner agrees to take any reasonable lawful action (including amendment of this Covenant as may be necessary) to comply fully with all applicable rules, rulings, or additional regulations relating and affecting the Project.

(f) If the Owner becomes aware of any situation, event or condition which would result in Non-compliance of the Project or the Owner with this Covenant, the Owner shall promptly give written notice thereof to the City.

(g) The Owner shall insure that the Designated Workforce Housing Units occupied by Qualifying Tenants with valid leases shall be of comparable quality to other apartment units of the Project; and the Designated Workforce Housing Units must be suitable for occupancy, subject to reasonable wear and tear. Notwithstanding the terms of this Section 3(g) the Qualifying Tenant, and not the Owner, shall remain fully responsible for any intentional or negligent acts of Qualifying Tenant, members of the Qualifying Tenants' household, and/or those in the Designated Workforce Housing Units or on the Property at the invitation or control of the Qualifying Tenant, which causes damage to the condition or habitability of the Designated Workforce Housing Units.

(h) Any Qualifying Tenant that does not abide by the terms of the lease or occupancy agreement, or by the terms of this Covenant, may be evicted from any Designated Workforce Housing Unit by the Owner, and said eviction, shall not change the character of the apartment as being designated as one of the Designated Workforce Housing Units during the time the tenant is being removed from the apartment, provided however, the apartment is re-rented to a new Qualifying Tenant subsequent to the prior Qualifying Tenant's eviction and removal.

Section 4. Records and Certifications.

(a) During the Term of this Covenant, the Owner shall deliver to the City, or its designee, any and all documents related to costs, expenses and income for the Designated Workforce Housing Units, required to be provided to the City or that the City's agents may require or request.

(b) During the Term of this Covenant, the Owner will maintain complete and accurate records pertaining to the Designated Workforce Housing Units which are the subject of this Covenant. Without limiting the generality of the foregoing, the Owner will obtain and maintain on file an Annual Income Certification from each Qualifying Occupant within any Designated Workforce Housing Units.

(c) the Owner will permit any duly authorized representative of the City to inspect, and make copies of the books and records of the Owner pertaining to the incomes of present, past or prospective Qualified Tenants of the Project upon reasonable notice and at reasonable times; and

(d) At all times during the term of this Covenant, the Owner shall maintain with the Planning Department of the City, or its designee, a Certification of Continuing Compliance including verification that the rent for the Designated Workforce Housing Units and that the Qualifying Tenants meet the definitions as provided in this covenant.

Section 5. Reliance. The Owner hereby agrees that the representations and covenants set forth herein and in the Annual Income Certification by the Owner to the City may be relied upon by the City. In performing its duties and obligations hereunder, the City may rely upon the statements and certificates of the Owner. In addition, at its own expense, the City may consult with counsel, and the opinion of such counsel shall be full and complete authorization and protection in respect of any action taken or suffered by the City hereunder in good faith and in conformity with the opinion of such counsel. In performing its duties and obligation hereunder, the Owner may rely upon certificates of Qualifying Tenants reasonably believed to be genuine and to have been executed by the proper person or persons.

Section 6. Term

(a) This Covenant became effective on _____ and shall remain in full force and effect for a period of thirty (30) years following the date of issuance of a certificate of occupancy, for the Designated Workforce Housing Units.

Section 7. Defaults and Remedies & Right to Cure. Any failure by the Owner to perform or comply with any obligation, agreement, covenant, or warranty of the Owner under this Covenant that is not corrected within a reasonable period after written notice from the City to the Owner setting forth the specific details of the event of default shall constitute an “event of default” hereunder. For the purposes of this Covenant a “reasonable period” is not more than sixty (60) days after such failure is first discovered by the Owner or would have been discovered by the exercise of reasonable diligence.

Upon the occurrence of an event of default hereunder that is not cured within 60 days after City provides Owner with a written notice of default, the City may take whatever action may be permitted at law or in equity or in this Covenant to enforce the obligations of and restrictions applying to the Owner hereunder. The City shall have the right to require the curing of any failure of the Owner to perform or comply with any obligation, agreement, covenant, or warranty of the Owner under this Covenant prior to the time such failure has become an event of default hereunder as the City may deem necessary.

Each Party acknowledges and agrees that a breach or threatened breach by such Party of any of its obligations hereunder would cause the other Party irreparable harm for which monetary damages would not be an adequate remedy and agrees that, in the event of breach or threatened breach, the other Party will be entitled to equitable relief, including a restraining order, an injunction, specific performance and any other relief that may be available from any court. Such remedies are not exclusive and are in addition to all other remedies that may be available at law, in equity or otherwise. Without limiting the generality of the foregoing, the City shall have the right to seek specific performance of any obligation, agreement, covenant, or warranty of the Owner

hereunder, whether or not failure to comply with the obligation, agreement, covenant or warranty for which specific performance is sought has become an event of default hereunder.

No remedy conferred upon or reserved to the City by this Covenant is intended to be exclusive of any other available remedy or remedies, but each such remedy shall be cumulative and shall be in addition to every other remedy given under this Covenant or any other document now or hereafter existing at law or in equity. No delay or omission to exercise any right or power accruing upon any failure of the Owner to perform or comply with any obligation, agreement, covenant, or warranty of the Owner under this Covenant shall impair any such right or power or shall be construed to be a waiver thereof.

The terms of this Section 7 are to ensure the Owner's compliance with the terms of this Covenant to the City only, namely, to provide the Designated Workforce Housing Units occupied by Qualifying Tenants as defined herein. At no time shall the terms of this Section 7 or the rights and remedies set forth under the terms of this Section 7, give any Qualifying Tenant any rights or remedies against the Owner for violation of the terms of this Covenant. In addition, at no time shall any Qualifying Tenant use or allege the Owner's breach of the terms of this Covenant, as grounds to avoid eviction from the Designated Workforce Housing Unit, if the Qualifying Tenant is otherwise in violation of the terms of its lease or occupancy agreement with the Owner.

Notwithstanding the terms of this Section 7, the Owner is not waiving any rights, remedies, or defenses, it might have to validly contest any alleged default of the Owner under this Covenant.

Section 8. Recording and Filing; Covenants To Run with the Land; Successors Bound.

(a) A signed executed Covenant shall be submitted to the Planning Department for recording at the Rockingham County Registry of Deeds.

(b) This Covenant and the covenants contained herein shall run with the land. These Covenants and the covenants contained herein shall bind, and the benefits shall inure to, respectively, the Owner and its successors and assigns and all subsequent Owners of the Project or any interest therein, the City's agent and each of the Qualifying Tenants during said Tenants' occupancy of a Designated Workforce Housing Unit during the Term of this Covenant.

Section 9. Governing Law. This Covenant shall be governed by the laws of the State of New Hampshire.

Section 10. Notices. Any notice, demand or other communication required or permitted hereunder shall be in writing unless explicitly permitted to be given otherwise than in writing and shall be deemed to have been given if personally delivered, or when deposited in United States express mail, postage prepaid, or with a private courier service guaranteeing next day delivery. Any such notice, demand or other communication shall be addressed as set forth below or to such other address as the entity to receive such notice may have designated to all other entities named in this list by notice in accordance herewith:

If to the Owner:

**Atlas Commons, LLC
3 Pleasant Street, Suite 400
Portsmouth, New Hampshire 03801**

If to the City:

**City Manager
Portsmouth City Hall
Municipal Complex
1 Junkins Avenue
Portsmouth, NH 03801**

Section 11. Severability. If any provision of this Covenant shall be invalid, illegal or unenforceable, the validity, legality and enforceability of the remaining portions shall not in any way be affected or impaired.

Section 12. Multiple Counterparts. This Covenant may be executed in counterparts, each of which shall be deemed to be an original, and such counterparts shall together constitute but one and the same instrument.

Section 13. Arbitration. In the event of any controversy or dispute arising out of or relating to this Covenant or the breach or default thereon, such controversy, breach, default, or dispute shall be resolved by arbitration in Rockingham County, New Hampshire, in an arbitration proceeding conforming to the rules of the American Arbitration Association.

Section 14. Modification or Amendment. Any modifications or amendments to this Covenant shall require approval by the Portsmouth Planning Board.

IN WITNESS WHEREOF, the Owner and the City have caused this Covenant to be executed under seal and by duly authorized representatives, all as of the date first written hereinabove.

CITY OF PORTSMOUTH

By: _____
Name and Title: Karen Conard, City Manager
Date: _____

Atlas Commons LLC

By: _____
Name and Title: Mark A. McNabb, Manager
Date: _____

ACKNOWLEDGEMENT

STATE OF NEW HAMPSHIRE
COUNTY OF ROCKINGHAM

This instrument was acknowledged before me on this ____ day of _____,
2024, by Karen Conard, Portsmouth City Manager.

Notary Public
(Seal, if any)
My Commission Expires:

STATE OF NEW HAMPSHIRE
COUNTY OF ROCKINGHAM

This instrument was acknowledged before me on this ____ day of _____,
2024, by Mark A. McNabb, Manager of Atlas Commons, LLC.

Notary Public/Justice of the Peace
(Seal, if any)
My Commission Expires: _____

After recording return to:
City of Portsmouth
Planning Department
1 Junkins Avenue
Portsmouth, NH 03801

EASEMENT FOR PUBLIC ACCESS AND USE OF COMMUNITY SPACE

THIS EASEMENT FOR PUBLIC ACCESS AND USE OF COMMUNITY SPACE (the “Community Space Easement”) is granted this ____ day of _____, 2024 by **Atlas Commons, LLC**, a New Hampshire limited company with an address of 3 Pleasant Street, Suite 400, City of Portsmouth, County of Rockingham, State of New Hampshire 03801, (“Grantor”) and for consideration of One Dollar (\$1.00) paid by the City, and other good and valuable consideration, receipt of which is acknowledged by Grantor, grants unto the **City of Portsmouth**, a municipal corporation, 1 Junkins Avenue, City of Portsmouth, County of Rockingham, State of New Hampshire 03801 (“City”) with warranty covenants, an easement for public access to and use of certain community space as set forth herein as a courtyard, outdoor dining café and wide pedestrian sidewalk easements.

WITNESSETH

WHEREAS, Grantor acquired a tract of land located at 581 Lafayette Road, City of Portsmouth, County of Rockingham, State of New Hampshire, identified as Map 229, Lot 8B (the “Property”), by Warranty Deed of John Galt, LLC, dated March 30, 2023 and recorded at the Rockingham County Registry of Deeds at Book 6474, Page 1538, where a future building to be known as 581 Lafayette Road will be constructed; and

WHEREAS, reference is made to a plan entitled “Community Space Plan,” prepared by Haley Ward, dated July, 2023, as revised, and recorded at the Rockingham County Registry of Deeds as Plan _____ (the “Easement Plan”); and

WHEREAS, reference is made to a site plan entitled “Site Plan,” prepared by Haley Ward, dated July, 2023, as revised, and recorded at the Rockingham County Registry of Deeds as Plan _____ (the “Site Plan”).

NOW THEREFORE, in consideration of the sum of One Dollar (\$1.00), to be paid, and other good and valuable consideration, the receipt of which is hereby acknowledged by the Grantor, Grantor conveys the easements as follows, located in the City of Portsmouth, County of Rockingham, State of New Hampshire (hereinafter collectively referred to as the “Easements”):

1. Wide Pedestrian Sidewalk Easement 1. The Grantor hereby grants to the City and declares for the benefit of the public a permanent right to use and enjoy the area identified on the Easement Plan as a “Wide Sidewalk Easement 1.”
2. Wide Pedestrian Sidewalk Easement 2. The Grantor hereby grants to the City and declares for the benefit of the public a permanent right to use and enjoy the area identified on the Easement Plan as a “Wide Sidewalk Easement 2.”
3. Courtyard Easement. The Grantor hereby grants to the City and declares for the benefit of the public a permanent right to use and enjoy the area identified on the Easement Plan as “Courtyard Easement.”

The Easements granted herein shall be subject to the following terms and conditions:

1. **Terms of Public Use:** The public use (the “Public Use”) permitted by the Easements shall be governed and determined at the sole discretion of the City, as expressed by the City Manager or the highest-ranking administrative officer of the City, subject to the terms and conditions of these easement. The City shall provide reasonable notice to the Grantor of an extraordinary event to be scheduled for the easement areas but failure to do so shall not be a breach of these easements.
2. **Rights to Private Property:** This Community Space Easement does not convey any right to the public to access or utilize the private property of the Grantor outside the easement areas. Grantor’s use of the Easements shall be subject to and regulated through the City of Portsmouth’s rules and ordinances governing public sidewalks.
3. **Maintenance:** Maintenance of the easement areas shall be the sole responsibility of the Grantor, its successors, or assigns. The City shall have the right, but not the obligation, to access the easement areas for the purpose of maintenance, repair, or replacement, after providing reasonable notice to the Grantor of the scope and cost of such work, all as reasonably determined by the City. Such maintenance costs incurred by the City shall be at the sole expense of the Grantor, its successors, or assigns.
4. **Encroachments:** The Easements are subject to all existing encroachments of utilities and improvements on, over and under the Easements.
5. **Covenants Run with the Land:** The Easements granted herein shall be perpetual in nature, shall run with the land and shall benefit and be binding upon the Grantor, its successors and assigns. The Easements shall be recorded in the Rockingham County Registry of Deeds.

6. **City Ordinance Application:** Any use, public or private, of the Easements shall be subject to and comply with the City Ordinances of the City of Portsmouth.

7. **Notices:** Any notice, demand, request, or other communication that either party desires or is required to give to the other under this Easement shall be in writing and either served personally or sent by United States mail, postage prepaid, certified, return receipt requested, and shall be mailed to the parties at the following addresses:

To Grantor:

Atlas Commons, LLC
3 Pleasant Street, Suite 400
Portsmouth, NH 03801

(or as listed and at the address shown on the City's current Tax Records)

To City:

City Manager (or the highest-ranking administrative officer)
City of Portsmouth, New Hampshire
1 Junkins Avenue
Portsmouth, NH 03801

8. **Amendment:** Grantor, or its successors and/or assigns, and City may mutually agree to amend or modify the Community Space Easement, provided that any such amendment or modification is approved by the City Council at a noticed public hearing, in writing and signed by both parties, and is consistent with the purpose and intent of the Zoning Ordinance. No amendment or modification of this Community Space Easement shall take effect unless and until it is recorded in the Rockingham County Registry of Deeds.

9. **Costs and Liabilities:** Grantor agrees to bear all costs and liabilities of any kind related to the operation, upkeep, and maintenance of the Property, and to defend, indemnify, hold harmless, and release the City of Portsmouth, from and against any and all actions, claims, damages, liabilities, or expenses that may be asserted by any person or entity, including Grantor, relating thereto. Without limiting the foregoing, the City of Portsmouth shall not be liable to Grantor or any other person or entity in connection with any entry upon the Property pursuant to this Community Space Easement, or on account of any claim, liability, damage, or expense suffered or incurred by or threatened against Grantor or any other person or entity, except as such claim, liability, damage, or expense is the result of the City of Portsmouth's, its agents or employee's negligence or willful misconduct.

10. **Applicable Law:** This Community Space Easement shall be construed and interpreted according to the substantive laws of the State of New Hampshire.

11. **Community Space Easement to Bind Successors:** The provisions of this Community Space Easement shall be binding upon and inure to the benefit of Grantor and its successors and

assigns. The Community Space Easement shall be appurtenant to, and for the benefit of, Grantee and shall run with title to the Property and shall continue in perpetuity.

Meaning and intending to convey an easement over a portion of the Property conveyed to the Grantor by Warranty Deed of John Galt, LLC, dated March 30, 2023, and recorded at the Rockingham County Registry of Deeds at Book 6474, Page 1538.

This is an exempt transfer pursuant to RSA 78-B:2(I).

IN WITNESS WHEREOF, Grantor and City have executed this Community Space Easement as set forth, below.

Grantor:

Atlas Commons, LLC

By: _____
Mark A. McNabb, Manager

Grantee:

City of Portsmouth, New Hampshire

By: _____
Karen S. Conard, City Manager

As authorized by vote of the Portsmouth City Council taken on _____, during its meeting that commenced on _____.

ACKNOWLEDGEMENTS

STATE OF NEW HAMPSHIRE
COUNTY OF ROCKINGHAM

On this ____ day of _____, 2024, before me, the undersigned notary public, personally appeared Mark A. McNabb, Manager of Atlas Commons, LLC, a New Hampshire limited liability company, proved to me through satisfactory evidence of identification, which was a valid driver's license, to be the person whose name is signed on the preceding or attached document, and acknowledged to me that he/she signed it voluntarily for its stated purpose.

Notary Public:
My Commission Expires:

STATE OF NEW HAMPSHIRE
COUNTY OF ROCKINGHAM

On this ____ day of _____, 2024, before: me, the undersigned notary public, personally appeared Karen S. Conard, City Manager of the City of Portsmouth New Hampshire, proved to me through satisfactory evidence of identification, which was a valid driver's license, to be the person whose name is signed on the preceding or attached document, and acknowledged to me that he/she signed it in his/her capacity as stated therein and voluntarily for its stated purpose.

Notary Public:
My Commission Expires:

MEMORANDUM OF AGREEMENT

THIS AGREEMENT (“Agreement”) is entered into this ____ day of, 2024, between the **Atlas Commons, LLC**, a New Hampshire limited liability company, with an address of 3 Pleasant Street, Suite 400, Portsmouth, NH 03801 (the “Developer”) and the **City of Portsmouth [School Board?]**, a New Hampshire municipality, with an address of 1 Junkins Avenue, Portsmouth, NH 03801 (the “City”). The Developer and the City may be collectively referred to herein as the “Parties.”

WITNESSETH:

WHEREAS, the Developer is the owner of certain real property located at 581 Lafayette Road in the City of Portsmouth, located at Tax Map/Lot 229/8B (the “Atlas Property”); and

WHEREAS, the City is the owner of certain adjacent real property located at 50 Andrew Jarvis Drive in the City of Portsmouth, located at Tax Map/Lot 229/3, which property currently serves at Portsmouth High School and which property contains a certain right of way abutting the Atlas Property known as Ledgewood Drive and associated cul-de-sac (the “School Property”); and

WHEREAS, the Developer has obtained certain approvals from the City’s land use boards to construct a 5-story mixed-use building with associated on-site and off-site improvements (see generally City permit number LU-23-189) (the “Developer’s Project”); and

WHEREAS, the Developer is seeking a density incentive bonus pursuant to Section 10.5B73 of the Portsmouth Zoning Ordinance (the “Ordinance”), and, as such, the Parties have entered into this Agreement to satisfy the requirements of Section 10.5B73.20 of the Ordinance and the Parties recognize the public benefit to be derived from creating greater pedestrian connectivity from Ledgewood Drive through and to the School Property; and

WHEREAS, the Parties desire for the Developer to contribute funds for the design, engineering and construction of certain public realm improvements within the School Property (collectively, and as further defined herein, the “Public Realm Improvements”).

NOW, THEREFORE, the Parties agree as follows:

Section I: The Developer’s Obligations.

A. The Public Realm Improvements

The Developer shall contribute the funds necessary [or \$ _____] (the “Contribution”) for the design, engineering and installation of the following and other minimal Public Realm Improvements shown on the plan set entitled, “Public Realm Plan,” dated January 4, 2024, as revised, prepared by Haley Ward and attached as Exhibit A within the School Property:

1. Installation of an 8 foot gravel path with lighting and benches that extends from the existing sidewalk on Ledgewood Drive over and across the School Property.

2. Installation of public benches, a bike rack, a picnic table, basketball court markings, and other minor infrastructure within the School Property.

3. All changes to the Public Realm Improvements from what is depicted in Exhibit A shall be agreed to in writing between the parties, submitted to the City Manager, in writing, and reviewed and approved by the Director of Public Works.

Section II: The City's Obligations

1. The City shall employ a third-party engineer for the construction of the Public Realm Improvements. The cost of the third-party engineer shall be paid by the funds being contributed hereunder. The parties acknowledge that the Contribution shall be the Developers sole responsibility, irrespective of the costs incurred by the City for the Public Realm Improvements.

2. The City hereby waives all fees applicable to the construction of the Public Realm Improvements. This provision shall not apply to any permit fees required pursuant to the Developer's Project.

3. The City shall designate a Project Manager for the Public Realm Improvements. All communications regarding the Public Realm Improvements from the Developer shall be addressed to the Project Manager, with a copy to the City Attorney.

4. All Public Realm Improvements shall be owned by the City.

Section III: Miscellaneous

1. Compliance with other laws: The Developer acknowledges that their obligations under this contract are subject to full compliance with all applicable state, federal, and local laws, and failure to adhere to such laws shall constitute a material breach of this contract.

2. Costs: Following acceptance of the Public Realm Improvements by the City, the City shall assume maintenance of the Public Realm Improvements. The City's maintenance obligations shall not exceed the ordinary maintenance responsibilities for any property in the City.

3. Entire Agreement. This Agreement and the attachments hereto, each of which is hereby incorporated herein, sets forth all the agreements, promises, covenants conditions and undertakings between the parties with respect to the subject matter hereof, and supersedes all prior and contemporaneous agreements and understandings, inducements, or conditions, express or implied, oral or written.

4. Amendment. No waiver or modification of any of the terms of this Agreement shall be valid unless in writing and signed by each of the parties hereto. Failure by any party to enforce

any rights under this Agreement shall not be construed as a waiver of such rights, and a waiver by any party of a default hereunder in one or more instances shall not be construed as constituting a continuing waiver or as a waiver of other instances of default.

5. Waiver of Breach: The failure of either party to enforce any provision of this contract shall not be construed as a waiver of subsequent breaches or as a relinquishment of the right to enforce such provisions. No waiver by either party of any breach of this contract shall be deemed to be a waiver of any other or subsequent breach.

6. Governing Law. The construction and effect of the terms of this Agreement shall be determined in accordance with the laws of the State of New Hampshire.

As authorized by vote of the Portsmouth City Council taken on _____, during its meeting that commenced _____.

Atlas Commons, LLC

By: _____
Mark. A. McNabb
Its Manager

STATE OF NEW HAMPSHIRE
COUNTY OF ROCKINGHAM

On this ____ day of _____, 2024, before: me, the undersigned notary public, personally appeared Mark A. McNabb, Manager of Atlas Commons, LLC, proved to me through satisfactory evidence of identification, which was a valid driver's license, to be the person whose name is signed on the preceding or attached document, and acknowledged to me that he signed it in his capacity as stated therein and voluntarily for its stated purpose.

Notary Public
My Commission expires:

City of Portsmouth, New Hampshire

By: _____
Karen S. Conard, City Manager

STATE OF NEW HAMPSHIRE
COUNTY OF ROCKINGHAM

On this ____ day of _____, 2024, before: me, the undersigned notary public, personally appeared Karen S. Conard, City Manager of the City of Portsmouth New Hampshire, proved to me through satisfactory evidence of identification, which was a valid driver's license, to be the person whose name is signed on the preceding or attached document, and acknowledged to me that she signed it in her capacity as stated therein and voluntarily for its stated purpose.

Notary Public:
My Commission Expires:

MEMORANDUM OF AGREEMENT

THIS AGREEMENT (“Agreement”) is entered into this ____ day of, 2024, between the **Atlas Commons, LLC**, a New Hampshire limited liability company, with an address of 3 Pleasant Street, Suite 400, Portsmouth, NH 03801 (the “Developer”) and the **City of Portsmouth [School Board?]**, a New Hampshire municipality, with an address of 1 Junkins Avenue, Portsmouth, NH 03801 (the “City”). The Developer and the City may be collectively referred to herein as the “Parties.”

WITNESSETH:

WHEREAS, the Developer is the owner of certain real property located at 581 Lafayette Road in the City of Portsmouth, located at Tax Map/Lot 229/8B (the “Atlas Property”); and

WHEREAS, the City is the owner of certain adjacent real property located at 50 Andrew Jarvis Drive in the City of Portsmouth, located at Tax Map/Lot 229/3, which property currently serves at Portsmouth High School and which property contains a certain right of way abutting the Atlas Property known as Ledgewood Drive and associated cul-de-sac (the “School Property”); and

WHEREAS, the Developer has obtained certain approvals from the City’s land use boards to construct a 5-story mixed-use building with associated on-site and off-site improvements (see generally City permit number LU-23-189) (the “Developer’s Project”); and

WHEREAS, the Developer is seeking a density incentive bonus pursuant to Section 10.5B73 of the Portsmouth Zoning Ordinance (the “Ordinance”), and, as such, the Parties have entered into this Agreement to satisfy the requirements of Section 10.5B73.20 of the Ordinance and the Parties recognize the public benefit to be derived from creating greater pedestrian connectivity from Ledgewood Drive through and to the School Property; and

WHEREAS, the Parties desire for the Developer, at its sole cost, to design, engineer and construct certain public realm improvements within the School Property (collectively, and as further defined herein, the “Public Realm Improvements”).

NOW, THEREFORE, the Parties agree as follows:

Section I: The Developer’s Obligations.

A. The Public Realm Improvements

The Developer shall, at its sole cost and obligation design, engineer and install the following and other minimal Public Realm Improvements shown on the plan set entitled, “Public Realm Plan,” dated January 4, 2024, as revised, prepared by Haley Ward and attached as Exhibit A within the School Property:

1. Install an 8 foot gravel path with lighting and benches that extends from the existing sidewalk on Ledgewood Drive over and across the School Property.

2. Install public benches, a bike rack, a picnic table, basketball court markings, and other minor infrastructure within the School Property.

3. All Public Realm Improvements made by the Developer on the School Property shall be compliant with the Americans with Disabilities Act (ADA),.

4. All changes to the Public Realm Improvements from what is depicted in Exhibit A shall be submitted to the City Manager in writing and reviewed and approved by the Director of Public Works.

B. Construction Obligations

The Developer shall complete at its sole cost and obligation the following tasks to secure the construction of the infrastructure described in Section I, A:

1. Prior to commencing any construction, the Developer shall submit construction plans to the City (the “Construction Plans”). The construction plans must be reviewed and approved by the Director of Public Works for consistency with City standards. The City may, at its sole discretion and cost, employ a third-party engineer to conduct a peer review of the construction plans.

2. The Developer shall secure the construction of the items above via a security instrument, such as a bond or letter of credit, in a form acceptable to the City Attorney. The value of the security instrument shall be estimated by the Developer and set by the Director of Public Works.

3. The Developer shall enter into a Construction Management Mitigation Agreement (CMMP) with the City sufficient to describe the Developer’s construction plan for the Public Realm Improvements and the Developer’s Project.

4. As a part of the CMMP, the Developer shall designate a Project Manager, who shall serve as the point of contact for all public inquiries regarding the Public Realm Improvements, the Developer’s Project, and the related impacts on vehicular travel. This point of contact shall be available to respond to public inquiries and respond to requests within 24 hours.

5. The Developer shall provide the City with proof of insurance at the City’s customary levels for the period of construction of the Public Realm Improvements. The proof of insurance shall list the City as an additional insured.

Section II: The City’s Obligations

1. The City shall employ a third-party engineer to oversee the construction of the Public Realm Improvements. The cost of the third-party engineer shall be paid by the City.

2. The City hereby waives all fees applicable to the construction of the Public Realm Improvements. This provision shall not apply to any permit fees required pursuant to the Developer's Project.

3. The City shall designate a Project Manager for the Public Realm Improvements. All communications regarding the Public Realm Improvements from the Developer shall be addressed to the Project Manager, with a copy to the City Attorney.

4. Following approval of the Public Realm Improvements by the City's third-party engineer and the Director of Public Works, the City shall accept ownership in writing of all Public Realm Improvements. If review by the City's third-party engineer or the City's Public Works Department reveal the Public Realm Improvements are not constructed to City standards or the Construction Plans, the Developer shall cause the insufficiencies to be remedied to the City's satisfaction.

Section III: Miscellaneous

1. Compliance with other laws: The Developer acknowledges that their obligations under this contract are subject to full compliance with all applicable state, federal, and local laws, and failure to adhere to such laws shall constitute a material breach of this contract.

2. Costs: Following acceptance of the Public Realm Improvements by the City, the City shall assume maintenance of the Public Realm Improvements. The City's maintenance obligations shall not exceed the ordinary maintenance responsibilities for any property in the City.

3. Entire Agreement. This Agreement and the attachments hereto, each of which is hereby incorporated herein, sets forth all the agreements, promises, covenants conditions and undertakings between the parties with respect to the subject matter hereof, and supersedes all prior and contemporaneous agreements and understandings, inducements, or conditions, express or implied, oral or written.

4. Amendment. No waiver or modification of any of the terms of this Agreement shall be valid unless in writing and signed by each of the parties hereto. Failure by any party to enforce any rights under this Agreement shall not be construed as a waiver of such rights, and a waiver by any party of a default hereunder in one or more instances shall not be construed as constituting a continuing waiver or as a waiver of other instances of default.

5. Waiver of Breach: The failure of either party to enforce any provision of this contract shall not be construed as a waiver of subsequent breaches or as a relinquishment of the right to enforce such provisions. No waiver by either party of any breach of this contract shall be deemed to be a waiver of any other or subsequent breach.

6. Governing Law. The construction and effect of the terms of this Agreement shall be determined in accordance with the laws of the State of New Hampshire.

As authorized by vote of the Portsmouth City Council taken on _____, during its meeting that commenced _____.

Atlas Commons, LLC

By: _____
Mark. A. McNabb
Its Manager

STATE OF NEW HAMPSHIRE
COUNTY OF ROCKINGHAM

On this ____ day of _____, 2024, before: me, the undersigned notary public, personally appeared Mark A. McNabb, Manager of Atlas Commons, LLC, proved to me through satisfactory evidence of identification, which was a valid driver's license, to be the person whose name is signed on the preceding or attached document, and acknowledged to me that he signed it in his capacity as stated therein and voluntarily for its stated purpose.

Notary Public
My Commission expires:

City of Portsmouth, New Hampshire

By: _____
Karen S. Conard, City Manager

STATE OF NEW HAMPSHIRE
COUNTY OF ROCKINGHAM

On this ____ day of _____, 2024, before: me, the undersigned notary public, personally appeared Karen S. Conard, City Manager of the City of Portsmouth New Hampshire, proved to me through satisfactory evidence of identification, which was a valid driver's license, to be the person whose name is signed on the preceding or attached document, and acknowledged to me that she signed it in her capacity as stated therein and voluntarily for its stated purpose.

Notary Public:
My Commission Expires:



LCHIP	ROA646155	25.00
RECORDING		22.00
SURCHARGE		2.00

WARRANTY DEED

JOHN GALT, LLC, a New Hampshire limited liability company with a mailing address of 3 Pleasant Street, Suite 400, Portsmouth, New Hampshire 03801 ("Grantor") for consideration paid grants to **ATLAS COMMONS, LLC**, a New Hampshire limited liability company with a mailing address of 3 Pleasant Street, Suite 400, Portsmouth, New Hampshire 03801 ("Grantee") **WITH WARRANTY COVENANTS**

THE FOLLOWING DESCRIBED PREMISES:

1. A certain tract or parcel of land, together with any buildings or improvements thereon, situate in Portsmouth, County of Rockingham and State of New Hampshire, bounded and described as follows:

Beginning at a point in the Easterly sideline of Lafayette Road at the Northwestern corner of the parcel herein described and at land of the City of Portsmouth; thence running North 81°43 East by City of Portsmouth land, two hundred eighty-one and seven tenths (281.7) feet to a corner at land of Ledgewood Manor Associates; thence turning and running South 5°56' West two hundred forty-six and thirty-one hundredths (246.31) feet, South 15°05'30" West fourteen and twenty-one hundredths (14.21) feet, South 07°12' West seventy-two and no hundredths (72.00) feet, South 48°45' East thirty-three and thirty-two hundredths (33.32) feet and South 39°04' East seventy-five and seven hundredths (75.07) feet, all by land of Ledgewood Manor Associates to a corner of land now or formerly of William N. Genimatas; thence turning and running North 84°04' West three hundred thirty and forty hundredths (330.40) feet by land of said Genimatas to Lafayette Road; thence turning and running North 05°56' East two hundred thirty-nine and thirty-nine hundredths (239.39) feet and North 05°31' West ninety-six and two tenths (96.2) feet by said Lafayette Road to the point of beginning. Containing 2.25 acres, more or less.

2. Together with the perpetual right to use in common with DLR, Inc., and William N. Genimatas, their heirs, devisees, successors and assigns, the Lafayette Road entrance-exit way as developed by DLR, Inc., (formerly MDL, Inc.) near the southwest corner of the land retained by Genimatas, together with the perpetual right hereby granted to grantees,

their heirs, devisees and assigns, to use in common with said DLR, Inc., and Genimatas, their heirs, devisees, successors and assigns, the other Lafayette Road entrance-exit ways on the DLR, Inc. and the Bowl-O-Rama lots adjoining the premises hereby conveyed.

3. Subject to, and with the benefit of mutual parking rights in common with said DLR, Inc., and said Genimatas respecting this lot and the adjoining Bowl-O-Rama and DLR, Inc., lots, namely and respectively, that said DLR, Inc., Genimatas and Robbins shall have free parking as may be necessarily available on any of these three parcels of land, and such parking rights for each of them in each other's adjacent land shall be mutually interchangeable, for said Genimatas, DLR, Inc., and said Robbins, their respective heirs, devisees, successors and assigns, such mutual parking rights and benefits to extend to any other persons or corporations and any other lands and premises, which said Genimatas, said Robbins, MGR Realty and/or MGR Realty, Inc., may have heretofore conveyed and reserved such rights, benefits or privileges. The foregoing parking rights shall not limit or restricts the rights of the owners of the said lots to construct buildings or additions to same, upon the said lots, provided no unreasonable imposition of owner's parking is caused the abutters by such buildings or additions thereto.
4. Also being conveyed with the benefit of, a certain right of way in common with others, including Petzold, et al, and Ledgewood Manor Associates on the Southerly part of the DLR, Inc., Lot #3, second lot south of this lot, said right of way being also subject to a restriction against the erection of a barrier, fence or other obstruction on either side of said right of way as it runs to Lafayette Road, all as per agreement acknowledged on July 23, 1973, recorded in Rockingham Registry of Deeds, Book 2209, Page 1400.
5. The foregoing premises are further conveyed subject to, and with the benefit of, a perpetual easement for a roadway thirty (30) feet in width extending from Lafayette Road on the South, adjacent to land of Petzold, running thence along the southerly and easterly boundary of the DLR (former Tower Restaurant) Lot of 1.92 acres, the easterly boundary of the Genimatas (Bowl-O-Rama) Lot of 2.82 acres, and the easterly boundary of the Robbins (Jerry Lewis Cinema) Lot of 2.25 acres, as shown on plan of "Subdivision of Land, Portsmouth, N.H., for Genimatas and Robbins" dated November 1978, Revised June 7, 1979 which roadway easement is reserved for use in common of, and the benefit in common of, William N. Genimatas, Henry J. Robbins, Joan M. Robbins, and DLR, Inc., and their respective heirs, devisees, successors and assigns. Owners of Lots #1, 2, and 3 in said Subdivision agree that they will equally contribute to development and maintenance of such thirty (30) foot right-of-right as a passable gravel way, excluding winter maintenance such as snow plowing and clearing way of snow, ice, slush or water.
6. The premises hereby conveyed (the "Premises") shall be SUBJECT TO the restriction (this "Use Restriction") that the business of a movie theater shall not be conducted or maintained upon the Premises or any portion thereof for a period of twenty (20) years from October 10, 2007, the date of the recording of the deed from Canavan Properties, LLC, to MANI Properties, LLC recorded in the Rockingham County Registry of Deeds at Book 4851, Page 526 (the "Restriction Term"). By the acceptance of this Deed, the within grantee agrees to be bound by this Use Restriction. This Use Restriction shall run with the land and be binding upon the within grantee, the within grantee's successor and

assigns, and the Premises and every part thereof for the duration of the Restriction Term; and in each and every Deed to the Premises or any portion thereof given during the Restriction Term, the then grantor shall undertake to insert a clause referring to this Use Restriction. This Use Restriction is for the benefit of Hoyts Cinemas Corporation, a Delaware Corporation, and its subsidiaries, and their respective successors and assigns (collectively, "Hoyts"), and Hoyts, as a former tenant of the Premises and for consideration paid to the within grantor, shall have the right to enforce this Use Restriction.

7. A portion of the above premises, more particularly bounded and described as set forth below, is subject to a perpetual easement for the installation and maintenance of utility lines:

A certain tract or parcel of land situate on the Easterly side of Lafayette Road, Portsmouth, Rockingham County, New Hampshire, described as follows:

Beginning at a point in the Easterly sideline of Lafayette Road at the Northwest corner of the parcel herein described and the Southwest corner of land of the City of Portsmouth; thence running North $81^{\circ}43'$ East two hundred eighty-one and seven tenths (281.7) feet to an iron pipe at land now or formerly of Ledgewood Manor Associates; thence turning and running South $05^{\circ}56'$ West by said Ledgewood Manor Associates land ten and thirty-two hundredths (10.32) feet to a corner at other land now or formerly of MGR Realty; thence turning and running South $81^{\circ}43'$ West sixty-seven and fifty-six hundredths (67.56) feet; South $59^{\circ}00'$ West ten and eighty-eight hundredths (10.88) feet and South $66^{\circ}12'$ West one hundred seventy-eight and ten hundredths (178.10) feet to a point; thence continuing on the arc of a curve to the left having a radius of 50 feet an arc distance of fifty-two and fifty-nine hundredths (52.59) feet to a point in the easterly sideline of Lafayette Road, said previous four courses being along land now or formerly of MGR Realty; thence turning and running North $05^{\circ}56'$ East one and sixty-nine hundredths (1.69) feet and North $05^{\circ}31'$ West ninety-six and two tenths (96.2) feet by the Easterly sideline of Lafayette Road to the point of beginning.

The said easement rights are preserved and more fully described in a certain Partial Termination of Easement granted by RPL Properties, LLC to DiLorenzo Lafayette Ledgewood Real Estate, LLC, dated November 3, 2015 and recorded in the Rockingham County Registry of Deeds as of the date hereof, and as set forth therein consist of the rights of RPL Properties, LLC, its successors and assigns ("RPL") to install, lay, maintain, replace and repair and use utility lines of all types including, without limitation, water mains, gas mains, electric wires (above and below grade) and telephone lines (above and below grade), storm and sanitary sewer drains and catch basins, together with all facilities related to the use, operations and maintenance of such utility lines, and the right to pass and re-pass over said premises for the foregoing purposes. Any such work performed by RPL shall be undertaken so as to minimize disruption, disturbance or damage to the premises herein conveyed, and once commenced, such work shall be diligently

pursued to completion. Any damage or disturbance to the premises herein conveyed shall be repaired or restored in a prompt and workmanlike manner as nearly as practicable to the condition that existed immediately prior to such damage or destruction.

Meaning and intending to convey Lot #1, as shown on plan entitled "Subdivision of Land, Portsmouth, N.H., for Genimatas and Robbins" dated November 1978, Revised June 7, 1979, being Durgin Plan #5558, File #689, drawn by John W. Durgin Civil Engineers, which Plan is recorded in the Rockingham County Registry of Deeds as Plan D-8806. See also Warranty Deed of DiLorenzo Lafayette Ledgewood Real Estate, LLC to Grantor dated November 9, 2015 and recorded in the Rockingham County Registry of Deeds at Book 5669, Page 667.

Meaning and intending to describe and convey the same premises conveyed to the Grantor by deed of OMJ Realty dated October 20, 2022 and recorded in the Rockingham County Registry of Deeds at Book 6448, Page 1309 on October 25, 2022.

Transfer Tax: This transfer is exempt from transfer tax pursuant to RSA 78-B:2, XXII.

Homestead: This is not homestead property.

March 30, 2023

John Galt, LLC

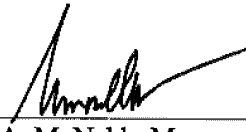
By: 
Mark A. McNabb, Manager

STATE OF NEW HAMPSHIRE
COUNTY OF ROCKINGHAM

The foregoing instrument was acknowledged before me this 30 day of March, 2023 by Mark A. McNabb, Manager of John Galt, LLC a New Hampshire limited liability company, on behalf of the company.

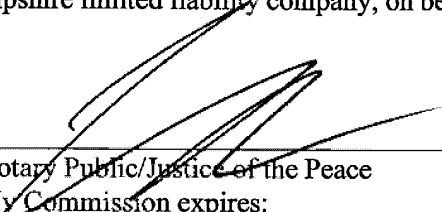
Notary Public/Justice of the Peace
My Commission expires:





581 Lafayette Apartment

Green Building Statement

12/20/2023

Energy modelling was performed using CoveTool software. The result show energy use intensity of the building is 25.64 kBtu/ft²/yr which is less than the average building with the same function, area, occupancy load and climate zone by 50%.

1 Passive Strategies

1.1 Orientation

The building orientation has been balancing between site efficiency and is to provide daylight optimizing as much solar orientation for passive heating and cooling strategies.

1.2 Shading

The building shading devices are designed to protect the fenestrations from excess solar radiation during the summer and provides passive heat by solar radiation during winter. This strategy helps to provide a comfort level for occupants and reduces the energy consumption of the building.

1.3 Envelope

1.3.1 Daylight

The envelope fenestrations are designed to maximize the natural daylight which provides a comfortable lighting level during the day and cuts down the energy consumption. The building will also have daylight and occupancy sensors, that helps to cut down the need for turning on the lighting fixtures.

1.3.2 Air Infiltration

The envelope is designed to meet 0.35 air changes per hour with tight envelope detailing and products such as smart membrane to seal the envelope.

1.3.3 Walls and roof insulation

The walls are designed to have cavity insulation of R-24 and continuous of R-16 to reduce the heat gains or losses. The roof is vented with R-60 insulation to reduce heat losses or gains as much as possible. Below grade walls and slabs have continuous R-20.

1.3.4 Fenestration performance

The building uses high-performance glazing with a maximum U-value of 0.26 and low E film to optimize solar heat gains or losses.

2 Active strategies

2.1 Mechanical Systems

The building uses a fresh air mechanical system with an energy recovery ventilator heat exchanger to capture heat from conditioned air before exhausting.,

2.2 Lighting fixtures

LED lighting with occupancy and daylight sensors throughout.

2.3 Appliances

Energy Star rating appliances.

Building Performance -- Use industry tools to monitor and benchmark buildings.

Train staff on proper building operation with comprehensive Facilities Staff Training protocols.

3 MATERIALS & RESOURCES

Minimize waste (during construction and operation)

Use regional, renewable materials

Embodied carbon interior finishes such as wood millwork, flooring, and natural fiber textiles.

Low carbon building materials such as concrete and insulation.

The strategies reduce reduce the CO2 impact by 50% compared to code minimum for similar building types and locations.

4 Renewable Energy

Rooftop Solar Photovoltaic system for 13% of the building's energy needs.

5 Water

Protect water quality -- Reduce parking asphalt by adding landscaped traffic aisles and edges.

Conserve Water -- Target 30% reduction in fixtures water use over building code, meeting EPACT 2005.

581 Lafayette Road Apartments

Energy Analysis

Dec. 20 2023

ANALYSIS SUMMARY

Location

581 Lafayette Rd, Portsmouth, NH 03801, USA

Climate Zone

ASHRAE Climate Zone 5

41

Walk Score®

Car-Dependent

47

Bike Score®

Somewhat Bikeable

Building Type

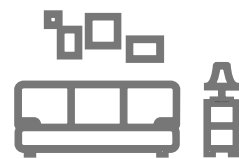

Apartments

25

Overall Energy

The current model is done using [ASHRAE 2019 - IECC 2021 Equivalent](#) energy code assumptions. The current design is [better](#) than the national average and can be significantly improved by higher performance of envelope, HVAC and more. The building load is driven by [Equipment](#) and [Hot Water](#).

BENCHMARKS

WHERE DO WE NEED TO BE?

Energy

58

National Average

EUI is expressed as energy per square foot per year. It is calculated by dividing the total energy consumed by the building in one year (measured in kBtu) by the total floor area of the building. The most common unit for EUI is kBtu/ft²/year.

12

2030 Target

55%

Daylight

Spatial Daylight Autonomy (sDA) describes the percentage of floor area that receives at least 300 lux for at least 50% of the annual occupied hours.

10%

Glare

Annual Solar Exposure (ASE) refers to the percentage of space that receives too much direct sunlight (1000 Lux or more for at least 250 occupied hours per year), which can cause glare or increased cooling loads.

ENERGY ANALYSIS

Baseline Energy

Proposed Whole Baseline EUI



Apartments **24.9** kBtu/ft²/yr

LEED Points - EAc2 Credit

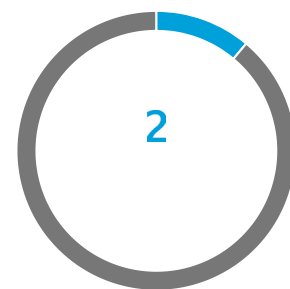

Electricity **\$288842.59** /yr
Gas **\$0** /yr

CO2 Reduction %

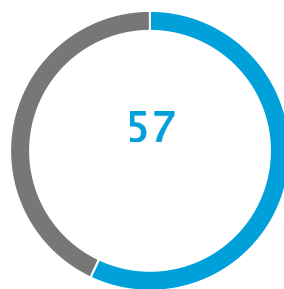

2030 Baseline Emissions **346.7** Tonne CO2e/yr
147.6 Tonne CO2e/yr
You Saved **30** Trucks of Ice/yr

Benchmarking Energy

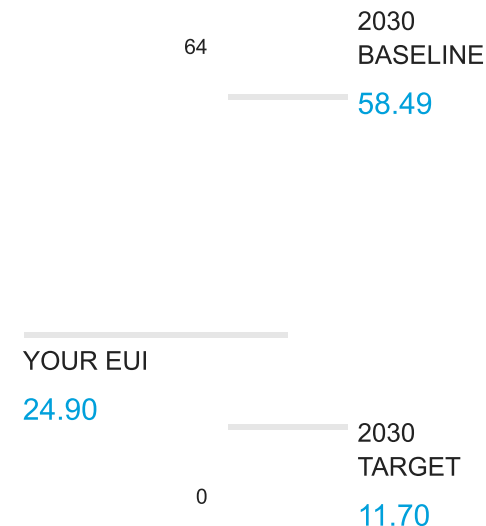

Proposed Whole Baseline EUI Breakdown

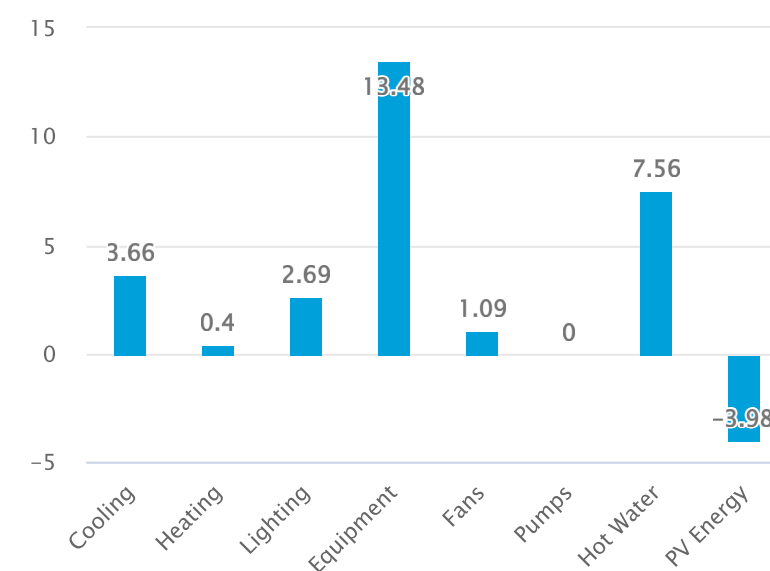

Cooling

Your cooling load is not dominating your energy use. This is because your HDD are higher than your CDD days.

Heating

Your heating load is not dominating your energy use. This makes sense - although your HDD days are higher than your CDD, the Equipment load is dominating the calculation. Look under the Usage and Schedules tab in the Engineering Inputs.

Lighting

Your lighting load contributes to 9.31% of the total EUI. You can reduce your lighting load by reducing your lighting power density and having daylight and occupancy sensors in the Engineering Inputs.

Equipment

Your equipment load is dominating your energy use. You can reduce your equipment load by reducing your appliance power density.

Hot Water

Your hot water load contributes to 26.17% of the total EUI. You can reduce your hot water load by reducing your domestic hot water demand and using a more efficient hot water generation system in Engineering Inputs.

Fans

Your fan load contributes to 3.77% of the total EUI. You can reduce your fan energy by switching your fan flow control accordingly in the Engineering Inputs. Total Outdoor Air for the project is 15135.46 CFM.

Pumps

Your pump load contributes to 0.0% of the total EUI. You can reduce your pump energy by adjusting pump control for cooling/heating in the Engineering Inputs.

PV Energy

The current Photovoltaic panels offset -3.98 EUI off the building.

Water Use

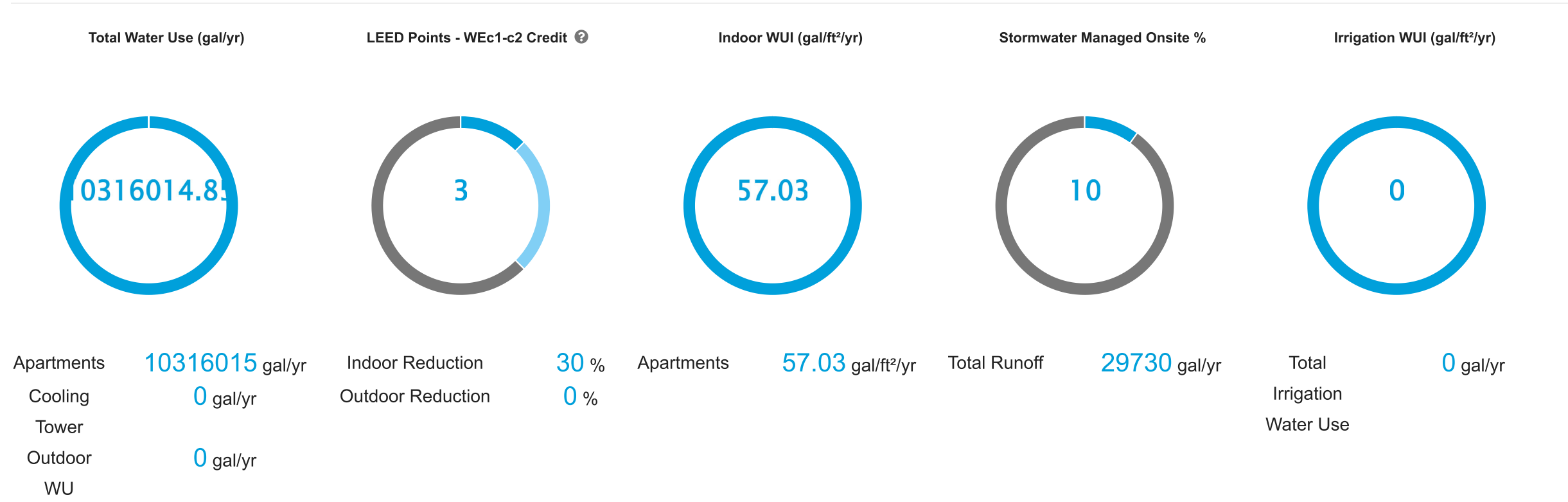

A5109-001
November 10, 2023

Mr. Roger Appleton, P.E.
Assistant District 6 Engineer
New Hampshire Department of Transportation
271 Main Street, P.O. Box 740
Durham, New Hampshire 03824

Re: **Trip Generation Memorandum
581 Lafayette Road Development
Portsmouth, New Hampshire**

Dear Roger:

Tighe & Bond has prepared a trip generation memorandum to outline the anticipated study area of the Traffic Impact Assessment (TIA) for the proposed Lafayette Road residential development located at 581 Lafayette Road (US Route 1) in Portsmouth, NH. The project proposes to add 72 residential units to the to the existing restaurant and restaurant/ indoor golf uses at 581 Lafayette Road. The site is bounded by Ledgewood Drive to the north, residential land use to the east, a shopping plaza to the south, and Lafayette Road (US Route 1) to the west. The project consists of the construction of 72 residential units in two new buildings adjacent to the existing building, which is to remain. Structured parking will be provided below the apartments on the ground level and basement levels of the building. The existing parking area will be reconfigured to accommodate the building addition. Access to the development will be provided via three driveways. The existing western entrance-only driveway located on Ledgewood Drive will be maintained. The existing eastern driveway on Ledgewood Drive will be replaced by two separate full-access driveways, one providing access to the structured parking and the other providing access to the surface parking spaces. The trip generation estimate for the proposed development will serve as the basis for the traffic impact assessment.

Study Area

Based on a preliminary review of expected trip generation and distribution for the surrounding area, the following intersections have been identified to be included in the study area:

- US Route 1 Bypass at Greenleaf Avenue (signalized)
- US Route 1 Bypass at Lafayette Road (US Route 1) (signalized)
- US Route 1 at North Shopping Plaza Driveway (Bowl-O-Rama/ Urgent Care)
- Lafayette Road (US Route 1) at Ledgewood Drive (signalized)
- Ledgewood Drive at East Site Driveway
- Ledgewood Drive at West Site Driveway

Turning movement count (TMC) data was collected at the study area intersections on Wednesday November 1, 2023 and Saturday November 4, 2023. Automatic traffic recorder (ATR) counts were collected along Ledgewood Drive in the vicinity of the site driveways. The ATR was installed for a 48-hour period from October 31 to November 1, 2023, collecting directional traffic volume flows and vehicular travel speeds.



The anticipated study area intersections are shown in Figure 1.

Traffic Volume Adjustments

The NHDOT continuous count station located along Route 16 (Spaulding Turnpike) between Exit 6 and Exit 7 (ID 02125090) will be used to compare 2023 traffic volumes to 2019 traffic volumes to determine if any adjustments to the turning movement counts are necessary per current NHDOT guidelines.

Trip Generation

Trips expected to be generated by the proposed development were estimated using the Institute of Transportation Engineers (ITE) Trip Generation, 11th Edition, 2021. Multifamily Housing (Mid-Rise) (LUC-221) was used to estimate vehicle trips generated by the development based on the current development program, which proposes 5-story buildings with structured parking on the ground level and residential units on floors 2 through 5.

Based on the ITE data, the proposed development is estimated to generate 27 trips (6 entering, 21 exiting) during the weekday morning peak hour, 28 trips (17 entering, 11 exiting) during the weekday afternoon peak hour, and 29 trips (15 entering, 14 exiting) during the Saturday midday peak hour. There will be no changes to the existing uses on site; trips generated by these uses will be captured through existing turning movement counts. Table 1 provides a detailed summary of the trip generation.

TABLE 1
Site-Generated Traffic Summary

Proposed - 72 Apartments Peak Hour Period	Enter	Exit	LUC Total
Weekday Morning	6	21	27
Weekday Afternoon	17	11	28
Saturday Midday	15	14	29
Weekday	164	163	327
Saturday	175	176	351

Source: Institute of Transportation Engineers, Trip Generation, 11th Edition, 2021
Land Use - 221 [Multifamily Housing (Mid-Rise)]

Trip Distribution

The distribution of the proposed traffic entering and exiting the site expected to be generated by the proposed residential use was reviewed based on U.S. Census journey-to-work data for people residing in Portsmouth. The following arrival/departure distributions are anticipated:

- 30% to/ from the North to Portsmouth Center via US Route 1
- 25% to/ from the South via US Route 1 (Lafayette Road)
- 20% to/ from the West to US Route 4 (Spaulding Turnpike) via US Route 1 Bypass
- 15% to/ from the South to I-95 South via Route 33
- 5% to/ from the West via Route 33



- 5% to/ from the North to I-95 North via US Route 1 Bypass

Based on the regional distribution, it is estimated that 45% of site traffic will access the site via US Route 1 Bypass to the northwest, 30% will access the site to/ from the northeast via US Route 1 and 25% will access the site to/ from the south via US Route 1.

Figure 1 presents the anticipated regional site traffic distributions of the traffic through the study area roadways.

Conclusion

The proposed development program includes 72 residential units. Based on the estimated trip generation and trip distribution, the TIA will analyze traffic operations at three intersections during the weekday morning, weekday afternoon, and Saturday midday peak periods.

Sincerely,

TIGHE & BOND, INC.

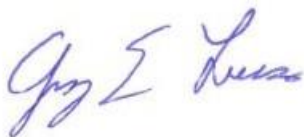

Greg Lucas, PE, PTOE, RSP1
Senior Project Manager

Copy: Marie Bodi, Atlas Commons, LLC
John Chagnon, Ambit Engineering, Inc.

Enclosures: Study Area Map (Figure 1)

\\tighebond.com\data\Data\Projects\A\A5109 Atlas Commons, LLC\001 - 581 Lafayette Road Traffic Study\Reports\2023-11-09 Trip Generation Memo\A5109-001 581 Lafayette Rd Trip Gen Memo.docx

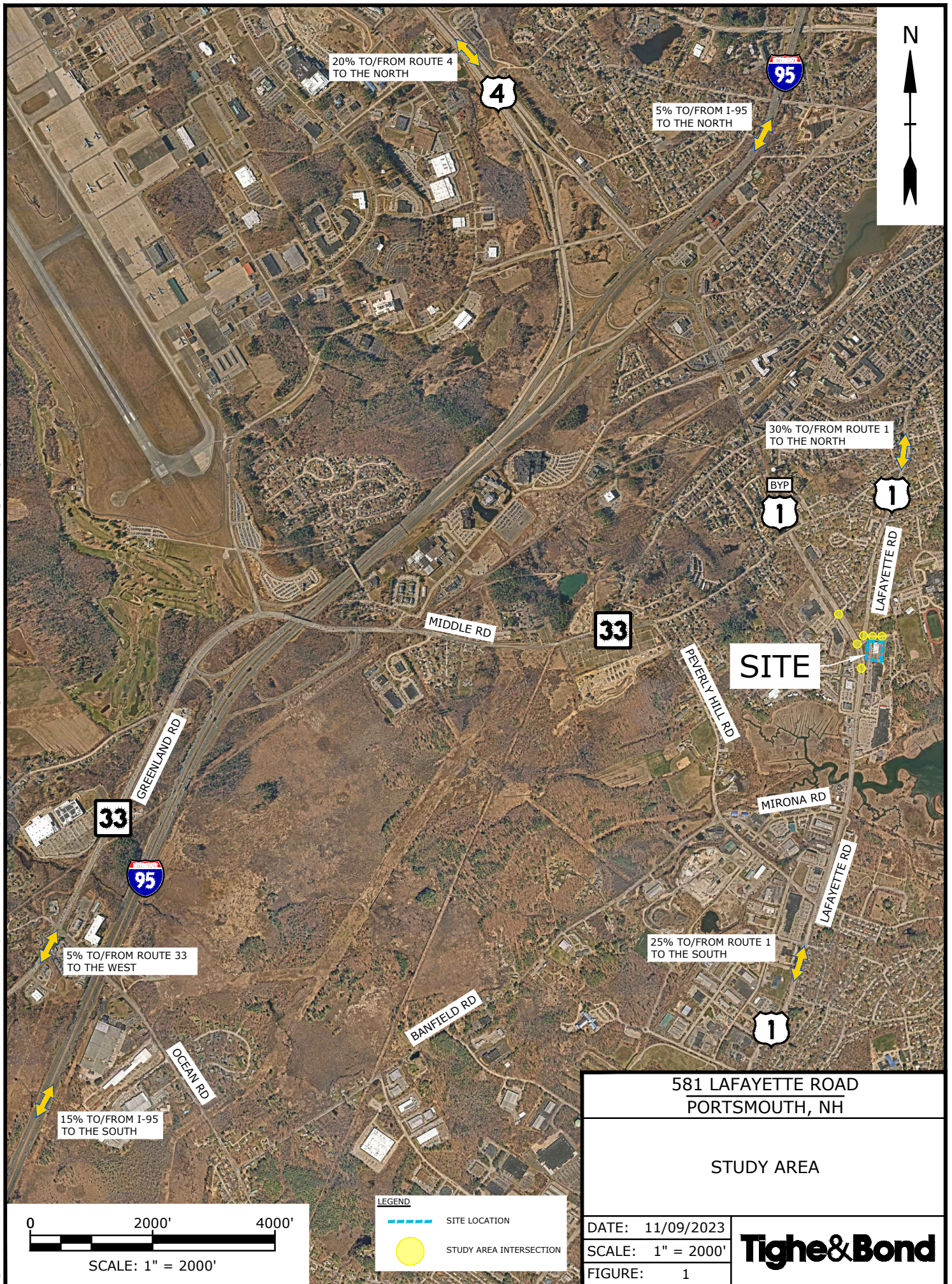



AMBIT ENGINEERING, INC.

A DIVISION OF HALEY WARD, INC.

200 Griffin Road, Unit 3, Portsmouth, NH 03801
Phone (603) 430-9282 Fax 436-2315

Bicycle & Pedestrian Network Plan

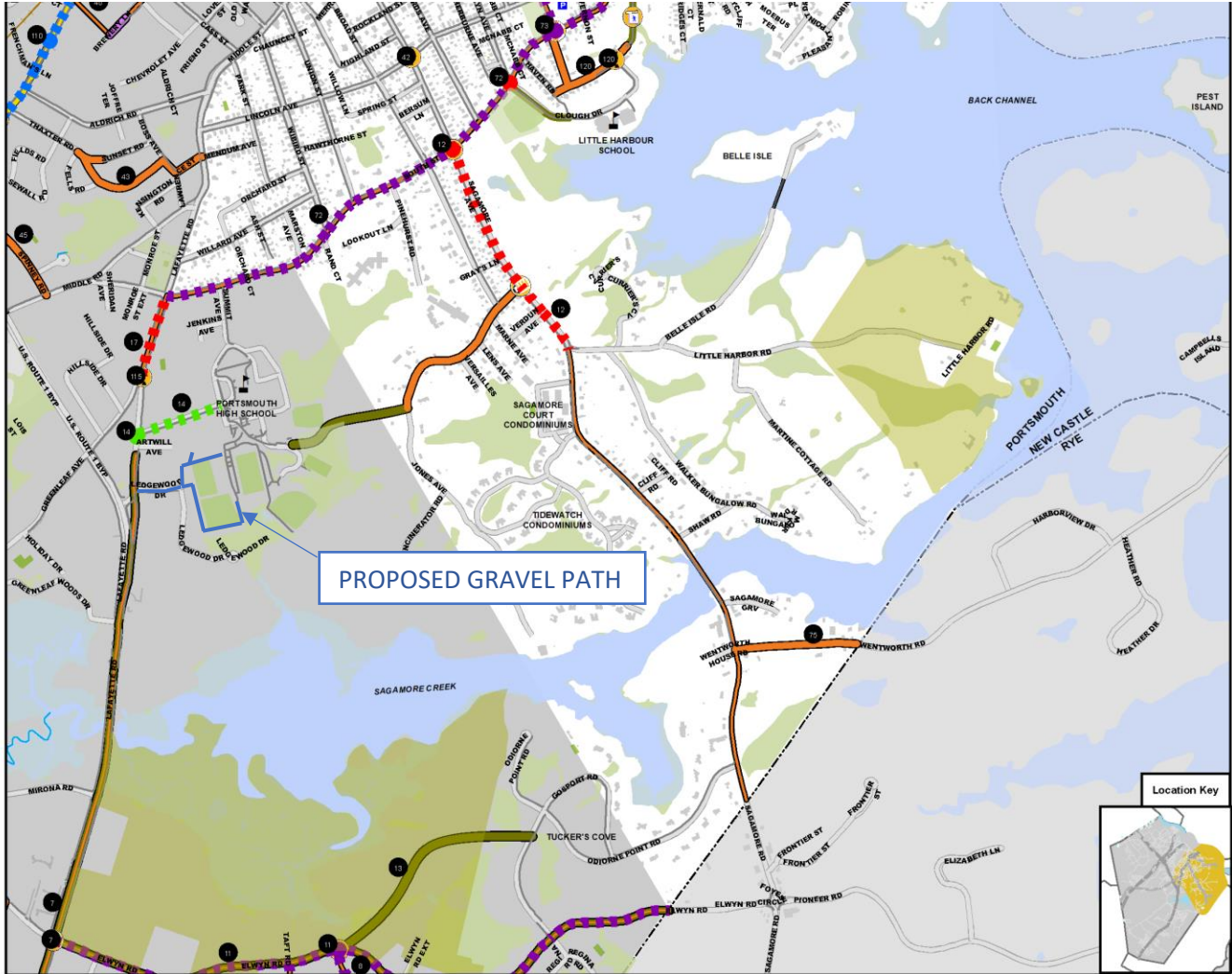

PROPOSED GRAVEL PATH

Location Key



City of Portsmouth
Bicycle and Pedestrian Plan
Pedestrian Network Plan
September 2018

- EXISTING FACILITIES**
- Side-Path, 1-Side
 - Shared-Use Path
 - Sidepath
 - Add Sidewalk, 2-Sides
 - Reconstruct Sidewalk
 - Widen Sidewalk
 - Shared Street
 - Pedestrian Street

- PROPOSED PEDESTRIAN IMPROVEMENTS**
- Completed
 - Under Const.
 - Designed/Wait Const.
 - In Design
 - In CIP

- SPOT IMPROVEMENT STATUS**
- Completed
 - Under Const.
 - Designed/Wait Const.
 - In Design
 - In CIP

- SPOT IMPROVEMENTS**
- Actuated Signal
 - ADA-Compliant Crosswalk
 - Curb Extensions
 - Intersection Geometry
 - Trailhead

- SPOT IMPROVEMENTS**
- Safe Access
 - Raised Intersection
 - Pedestrian Refuge
 - Pedestrian-Scale Lighting



UGN-30081

Gini 1 Downlight



72w LED 4984 Lumens
IP65 • Suitable For Wet Locations
IK07 • Impact Resistant
Weight 30.6 lbs

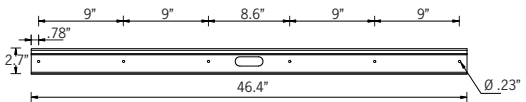

Mounting Detail



Construction

Aluminum

Less than 0.1% copper content – Marine Grade 6060 extruded & LM6 Aluminum High Pressure die casting provides excellent mechanical strength, clean detailed product lines and excellent heat dissipation.

Pre paint

8 step degrease and phosphate process that includes deoxidizing and etching as well as a zinc and nickel phosphate process before product painting.

Memory Retentive -Silicon Gasket

LM6 Aluminum is used for its excellent mechanical strength and thermal dissipation properties in low and high ambient temperatures. The superior thermal heat sink design by Ligman used in conjunction with the driver, controls thermals below critical temperature range to ensure maximum luminous flux output, as well as providing long LED service life and ensuring less than 10% lumen depreciation at 50,000 hours.

Thermal management

LM6 Aluminum is used for its excellent mechanical strength and thermal dissipation properties in low and high ambient temperatures. The superior thermal heat sink design by Ligman used in conjunction with the driver, controls thermals below critical temperature range to ensure maximum luminous flux output, as well as providing long LED service life and ensuring less than 10% lumen depreciation at 50,000 hours.

Surge Suppression

Standard 10kv surge suppressor provided with all fixtures.

BUG Rating

B2 - U1 - G1

Finishing

All Ligman products go through an extensive finishing process that includes fettling to improve paint adherence.

Paint

UV Stabilized 4.9mil thick powder coat paint and baked at 200 Deg C. This process ensures that Ligman products can withstand harsh environments. Rated for use in natatoriums.

Inspired by Nature Finishes

The Inspired by nature Finishing is a unique system of decorative powder coating. Our metal decoration process can easily transform the appearance of metal or aluminum product into a wood grain finish.

This patented technology enables the simulation of wood grain, and even marble or granite finish through the use of decorative powder coating.

The wood grain finish is so realistic that it's almost undistinguishable from real wood, even from a close visual inspection. The system of coating permeates the entire thickness of the coat and as a result, the coating cannot be removed by normal rubbing, chipping, or scratching.

The Coating Process

After pre-treatment the prepared parts are powder coated with a specially formulated polyurethane powder. This powder provides protection against wear, abrasion, impact and corrosion and acts as the relief base color for the finalized metal decoration.

The component is then wrapped with a sheet of non-porous film with the selected decoration pattern printed on it using special high temperature inks.

This printed film transfer is vacuum-sealed to the surface for a complete thermo print and then transferred into a customized oven. The oven transforms the ink into different forms within the paint layer before it becomes solid. Finally, the film is removed, and a vivid timber look on aluminum remains.

Wood grain coating can create beautiful wood-looking products of any sort. There are over 300 combinations of designs currently in use. Wood grains can be made with different colors, designs, etc.

Our powder coatings are certified for indoor and outdoor applications and are backed by a comprehensive warranty. These coatings rise to the highest conceivable standard of performance excellence and design innovation.

Added Benefits

- Resistance to salt-acid room, accelerated aging
- Boiling water, lime and condensed water resistant
- Anti-Graffiti, Anti-Slip, Anti-Microbial, Anti-Scratch
- Super durable (UV resistant)
- TGIC free (non-toxic)

Hardware

Provided Hardware is Marine grade 316 Stainless steel.

Anti Seize Screw Holes

Tapped holes are infused with a special anti seize compound designed to prevent seizure of threaded connections, due to electrolysis from heat, corrosive atmospheres and moisture.

Crystal Clear Low Iron Glass Lens

Provided with tempered, impact resistant crystal clear low iron glass ensuring no green glass tinge.

Optics & LED

Precise optic design provides exceptional light control and precise distribution of light. LED CRI > 80

Lumen - Maintenance Life

L80 /B10 at 50,000 hours (This means that at least 90% of the LED still achieve 80% of their original flux)

Slimline, surface wall-fixtures with up-down-light distribution. Clean, unique, minimalistic and flexible, the perfect tool for surface wall grazing. Frosted lens standard.

A range of modular top quality decorative linear surface mount luminaires. This small profile decorative wall sconce with upward, downward or up/down light distributions is available in 4 sizes, namely 12", 23" 35" and 47" standard lengths. (Contact factory for longer runs)

This luminaire has a unique feature where the extruded aluminum mounting bracket is secured onto the wall and the luminaire are then attached to the mounting bracket.

This modular feature allows for extended lengths of extruded mounting bracket to be installed onto the wall and then multiple luminaires can be attached end-on-end to provide a continuous row of luminaires with even light distribution. The Gini has been designed with integral drivers and lightly frosted low glare tempered glass lenses. A single gang in wall junction box, horizontally mounted is to be provided by contractor to facilitate ease of installation.

This IP65 luminaire can be used for indoor, as well as outdoor applications. Ideally suited to illuminate wall surfaces and light accents.

To meet International Dark Sky criteria, 3000k or warmer LEDs must be selected and luminaire fix mounted (+/- 15° allowable to permit leveling).



ULEW-30001

Leeds 1 Small Surface Wedge Downlight



5.5w LED 570 Lumens
 IP65 • Suitable For Wet Locations
 IK07 • Impact Resistant
 Weight 5 lbs

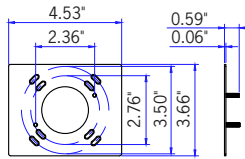
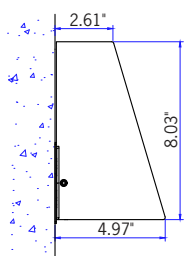
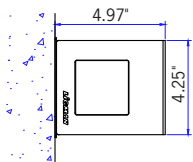

Mounting Detail

Construction

Aluminum

Less than 0.1% copper content - Marine Grade 6060 extruded & LM6 Aluminum High Pressure die casting provides excellent mechanical strength, clean detailed product lines and excellent heat dissipation.

Pre paint

8 step degrease and phosphate process that includes deoxidizing and etching as well as a zinc and nickel phosphate process before product painting.

Memory Retentive -Silicon Gasket

Provided with special injection molded "fit for purpose" long life high temperature memory retentive silicon gaskets. Maintains the gaskets exact profile and seal over years of use and compression.

Thermal management

LM6 Aluminum is used for its excellent mechanical strength and thermal dissipation properties in low and high ambient temperatures. The superior thermal heat sink design by Ligman used in conjunction with the driver, controls thermals below critical temperature range to ensure maximum luminous flux output, as well as providing long LED service life and ensuring less than 10% lumen depreciation at 50,000 hours.

Surge Suppression

Standard 10kv surge suppressor provided with all fixtures.

BUG Rating

Contact Factory

Finishing

All Ligman products go through an extensive finishing process that includes fettling to improve paint adherence.

Paint

UV Stabilized 4.9Mil thick powder coat paint and baked at 200 Deg C. This process ensures that Ligman products can withstand harsh environments. Rated for use in natatoriums.

Inspired by Nature Finishes

The Inspired by nature Finishing is a unique system of decorative powder coating. Our metal decoration process can easily transform the appearance of metal or aluminum product into a wood grain finish.

This patented technology enables the simulation of wood grain, and even marble or granite finish through the use of decorative powder coating.

The wood grain finish is so realistic that it's almost undistinguishable from real wood, even from a close visual inspection. The system of coating permeates the entire thickness of the coat and as a result, the coating cannot be removed by normal rubbing, chipping, or scratching.

The Coating Process

After pre-treatment the prepared parts are powder coated with a specially formulated polyurethane powder. This powder provides protection against wear, abrasion, impact and corrosion and acts as the relief base color for the finalized metal decoration.

The component is then wrapped with a sheet of non-porous film with the selected decoration pattern printed on it using special high temperature inks.

This printed film transfer is vacuum-sealed to the surface for a complete thermo print and then transferred into a customized oven. The oven transforms the ink into different forms within the paint layer before it becomes solid. Finally, the film is removed, and a vivid timber look on aluminum remains.

Wood grain coating can create beautiful wood-looking products of any sort. There are over 300 combinations of designs currently in use. Wood grains can be made with different colors, designs, etc.

Our powder coatings are certified for indoor and outdoor applications and are backed by a comprehensive warranty. These coatings rise to the highest conceivable standard of performance excellence and design innovation.

Added Benefits

- Resistance to salt-acid room, accelerated aging
- Boiling water, lime and condensed water resistant
- Anti-Graffiti, Anti-Slip, Anti-Microbial, Anti-Scratch
- Super durable (UV resistant)
- TGIC free (non-toxic)

Hardware

Provided Hardware is Marine grade 316 Stainless steel.

Anti Seize Screw Holes

Tapped holes are infused with a special anti seize compound designed to prevent seizure of threaded connections, due to electrolysis from heat, corrosive atmospheres and moisture.

Crystal Clear Low Iron Glass Lens

Provided with tempered, impact resistant crystal clear low iron glass ensuring no green glass tinge.

Optics & LED

Precise optic design provides exceptional light control and precise distribution of light. LED CRI > 80

Lumen - Maintenance Life

L80 /B10 at 50,000 hours (This means that at least 90% of the LED still achieve 80% of their original flux)

Clean, beautiful, surface wall fixtures with class leading performance. Minimalist form, yet the most powerful and flexible lighting tool of its type, offering packages up to 2,400 lumens and microVos technology.

A range of small, square and rectangular, ADA compliant wall mounted luminaires with options of upward or downward light distributions. Ideally suited to illuminate the wall and surfaces in front of wall and for light accents on vertical surfaces using high efficiency LED's. The Leeds is suitable for indoor and outdoor applications and provides a clean, visually appealing solution for small, unobtrusive wall mounted luminaires.

This luminaire is available in 3 different sizes and in combinations of down, up or up/down light distributions.

This fixture utilizes microVos technology, meaning the ability to do Type I,II,III,IV & V distributions as well as hybrid distributions to suit the designer's requirements.

Using the microVos optics allows for very wide spacing to mounting height ratios, while still providing perfect uniformity and code compliant light levels.

To meet International Dark Sky criteria, 3000k or warmer LEDs must be selected and luminaire fix mounted (+/- 15° allowable to permit leveling).

Additional Options (Consult Factory For Pricing)

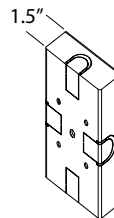

SCDT
Surface Conduit Decorative Trim

NOTE: This decorative trim does not function as a junction box. Wire connections should be made inside the luminaire

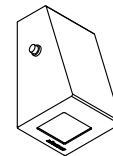

BPC
Button Photocell



Ligman's micro Variable Optical System provides the ability to interchange, mix & rotate optics to provide specific light distributions for optimized spacing and uniformity.

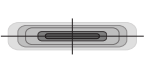

Type I

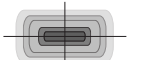

Type II

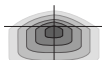

Type III

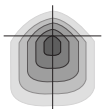

Type IV



Type V

ULEW-30021

Leeds 3 Large Surface Wedge Downlight



20w LED 2422 Lumens • 28w LED 3200 Lumens
 IP65 • Suitable For Wet Locations
 IK07 • Impact Resistant
 Weight 18 lbs

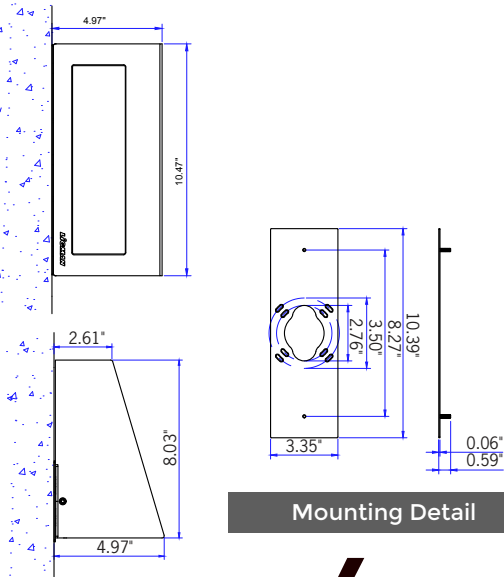

Mounting Detail



Ligman's micro Variable Optical System provides the ability to interchange, mix & rotate optics to provide specific light distributions for optimized spacing and uniformity.

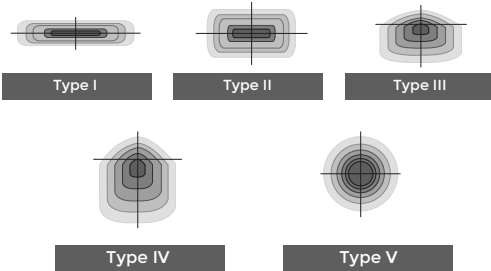

The variable optic system allows for the designer to create hybrid distributions for precise lighting requirements.

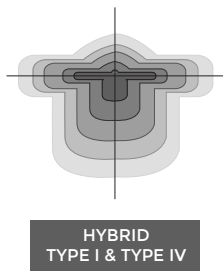

HYBRID TYPE I & TYPE IV

Construction

Aluminum.
 Less than 0.1% copper content - Marine Grade 6060 extruded & LM6 Aluminum High Pressure die casting provides excellent mechanical strength, clean detailed product lines and excellent heat dissipation.

Pre paint
 8 step degrease and phosphate process that includes deoxidizing and etching as well as a zinc and nickel phosphate process before product painting.

Memory Retentive -Silicon Gasket
 Provided with special injection molded "fit for purpose" long life high temperature memory retentive silicon gaskets. Maintains the gaskets exact profile and seal over years of use and compression.

Thermal management
 LM6 Aluminum is used for its excellent mechanical strength and thermal dissipation properties in low and high ambient temperatures. The superior thermal heat sink design by Ligman used in conjunction with the driver, controls thermal below critical temperature range to ensure maximum luminous flux output, as well as providing long LED service life and ensuring less than 10% lumen depreciation at 50,000 hours.

Surge Suppression
 Standard 10kv surge suppressor provided with all fixtures.

BUG Rating
 B1 - U0 - G0

Finishing.
 All Ligman products go through an extensive finishing process that includes fettling to improve paint adherence.

Paint
 UV Stabilized 4.9Mil thick powder coat paint and baked at 200 Deg C. This process ensures that Ligman products can withstand harsh environments. Rated for use in natatoriums.

Inspired by Nature Finishes
 The Inspired by nature Finishing is a unique system of decorative powder coating. Our metal decoration process can easily transform the appearance of metal or aluminum product into a wood grain finish.

This patented technology enables the simulation of wood grain, and even marble or granite finish through the use of decorative powder coating.

The wood grain finish is so realistic that it's almost undistinguishable from real wood, even from a close visual inspection. The system of coating permeates the entire thickness of the coat and as a result, the coating cannot be removed by normal rubbing, chipping, or scratching.

The Coating Process
 After pre-treatment the prepared parts are powder coated with a specially formulated polyurethane powder. This powder provides protection against wear, abrasion, impact and corrosion and acts as the relief base color for the finalized metal decoration.

The component is then wrapped with a sheet of non-porous film with the selected decoration pattern printed on it using special high temperature inks.

This printed film transfer is vacuum-sealed to the surface for a complete thermo print and then transferred into a customized oven. The oven transforms the ink into different forms within the paint layer before it becomes solid. Finally, the film is removed, and a vivid timber look on aluminum remains.

Wood grain coating can create beautiful wood-looking products of any sort. There are over 300 combinations of designs currently in use. Wood grains can be made with different colors, designs, etc.

Our powder coatings are certified for indoor and outdoor applications and are backed by a comprehensive warranty. These coatings rise to the highest conceivable standard of performance excellence and design innovation.

- Added Benefits**
- Resistance to salt-acid room, accelerated aging
 - Boiling water, lime and condensed water resistant
 - Anti-Graffiti, Anti-Slip, Anti-Microbial, Anti-Scratch
 - Super durable (UV resistant)
 - TGIC free (non-toxic)

Hardware
 Provided Hardware is Marine grade 316 Stainless steel.

Anti Seize Screw Holes
 Tapped holes are infused with a special anti seize compound designed to prevent seizure of threaded connections, due to electrolysis from heat, corrosive atmospheres and moisture.

Crystal Clear Low Iron Glass Lens
 Provided with tempered, impact resistant crystal clear low iron glass ensuring no green glass tinge.

Optics & LED
 Precise optic design provides exceptional light control and precise distribution of light. LED CRI > 80

Lumen - Maintenance Life
 L80 /B10 at 50,000 hours (This means that at least 90% of the LED still achieve 80% of their original flux)

Clean, beautiful, surface wall fixtures with class leading performance. Minimalist form, yet the most powerful and flexible lighting tool of its type, offering packages up to 2,400 lumens and microVos technology.

A range of small, square and rectangular, ADA compliant wall mounted luminaires with options of upward or downward light distributions. Ideally suited to illuminate the wall and surfaces in front of wall and for light accents on vertical surfaces using high efficiency LED's. The Leeds is suitable for indoor and outdoor applications and provides a clean, visually appealing solution for small, unobtrusive wall mounted luminaires.

This luminaire is available in 3 different sizes and in combinations of down, up or up/down light distributions.

This fixture utilizes microVos technology, meaning the ability to do Type I,II,III,IV & V distributions as well as hybrid distributions to suit the designer's requirements.

Using the microVos optics allows for very wide spacing to mounting height ratios, while still providing perfect uniformity and code compliant light levels.

To meet International Dark Sky criteria, 3000k or warmer LEDs must be selected and luminaire fix mounted (+/- 15° allowable to permit leveling).

Additional Options (Consult Factory For Pricing)

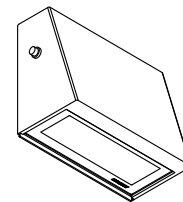

BPC Button Photocell

Average Existing Grade Worksheet

Project	581 Lafayette Road				Calculated			
Address:	581 Lafayette Road Portsmouth NH				1/18/2024			
No Offset from Building; Existing Grades 5' OC								
SECTION	Elev	Elev	Elev	Elev	Total			
WEST	24.54	24.73	24.83	24.81	98.91	AVG PER SECTION		
	24.80	24.81	24.82	24.83	99.26			
	24.84	24.85	24.86	24.88	99.43			
	24.89	24.88	24.84	24.85	99.46			
	24.84	24.83	24.82	24.82	99.31			
	24.81	24.81	24.83	24.83	99.28			
	24.93	24.93	24.85	24.82	99.53			
	24.81	24.81	24.81	24.82	99.25			
	24.88	24.87	24.85	24.82	99.42			
	24.83	24.79	24.77	24.80	99.19			
	24.82	24.85	24.86		74.53			
				#	43.0		1067.57	24.83
	NORTH	24.86	24.85	24.84	24.83		99.38	AVG PER SECTION
24.82		24.81	24.84	24.84	99.31			
24.83		24.85	24.83	24.88	99.39			
24.89		24.90	24.91	24.79	99.49			
24.75		24.71	24.90		74.36			
			#	19.0	471.93	24.84		
EAST	24.86	24.83	24.53	24.59	98.81	AVG PER SECTION		
	24.67	24.78	24.80	24.60	98.85			
	24.46	24.54	24.58	24.62	98.20			
	24.69	24.15	24.80	24.05	97.69			
	24.67	24.58	24.79	24.78	98.82			
	24.78	24.78	24.75	24.89	99.20			
	24.90	24.90	24.91	24.99	99.70			
	24.99	25.00	24.94	24.81	99.74			
	24.89	24.90	24.90	24.91	99.60			
	24.91	24.89	24.87	24.78	99.45			
	24.66	24.53	24.41	24.31	97.91			
	24.14				24.14			
				#	45.0		1112.11	24.71
SOUTH	24.55	24.48	24.43	24.45	97.91	AVG PER SECTION		
	24.48	24.51	24.57	24.57	98.13			
	24.55	24.53	24.54	24.60	98.22			
	24.84	24.80	24.79	24.61	99.04			
			#	16	393.30	24.58		
Total	3,044.91	>	AVERAGE GRADE					
#	123		24.76					

Average Proposed Grade Worksheet

Project	581 Lafayette Road				Calculated	
Address:	581 Lafayette Road Portsmouth NH				1/18/2024	
No Offset from Building; Proposed Grades 5' OC						
SECTION	Elev	Elev	Elev	Elev	Total	
EAST	23.40	23.40	23.40	23.40	93.60	
	23.40	23.40	23.40	23.40	93.60	
	23.40	23.40	23.40	23.40	93.60	
	23.40	23.40	23.40	23.40	93.60	
	23.40	23.40	23.40	23.40	93.60	
	23.40	23.40	23.40	23.40	93.60	
	23.40	23.40	23.40	23.40	93.60	
	23.40	23.40	23.40	23.40	93.60	
	23.40	23.40	23.40	23.40	93.60	
	23.40	23.40	23.40	23.40	93.60	
	23.40	23.40	23.40	23.40	93.60	
	23.40	23.50	23.50	23.50	93.90	
	23.50	23.50	23.50	23.50	94.00	
	23.50	23.50	23.50	23.50	94.00	
	23.50	23.50	23.50	23.50	47.00	AVG PER SECTION
				#	66.0	1545.70
SOUTH	23.40	23.40	23.40	23.40	93.60	
	23.40	23.50	23.50	23.50	93.90	
	23.40	23.40	23.40	23.40	93.60	
	23.40	23.40	23.40	23.40	93.60	
	23.40	23.40	23.40	23.40	93.60	
	23.40	23.40	23.40	23.40	93.60	
	23.40	23.40	23.40	23.40	93.60	
	23.40	23.40	23.40	23.40	93.60	
	23.40	23.40	23.40	23.40	46.80	AVG PER SECTION
			#	34.0	795.90	23.41
WEST	23.90	23.90	23.90	23.90	95.60	
	23.90	23.90	23.90	23.90	95.60	
	23.40	23.40	23.40	23.40	93.60	
	23.40	23.90	23.90	23.90	95.10	
	23.90	23.90	23.90	23.90	95.60	
	23.90	24.90	24.55	24.55	97.90	
	24.54	24.73	24.83	24.81	98.91	
	24.80	24.81	24.82	24.83	99.26	
	24.84	24.85	24.86	24.88	99.43	
	24.89	24.88	24.84	24.85	99.46	
	24.84	24.83	24.82	24.82	99.31	
	24.81	24.81	24.83	24.83	99.28	
	24.93	24.93	24.85	24.82	99.53	
	24.81	24.81	24.81	24.82	99.25	
	24.88	24.87	24.85	24.82	99.42	
	24.83	24.79	24.77	24.80	99.19	
24.82	24.85	24.86		74.53	AVG PER SECTION	
			#	67.0	1640.97	24.49
NORTH	24.86	24.85	24.84	24.83	99.38	
	24.82	24.81	24.84	24.84	99.31	
	24.83	24.85	24.83	24.88	99.39	
	24.89	24.90	24.91	24.79	99.49	
	24.75	24.71	24.90	24.86	99.22	
	24.83	24.53	24.59	24.67	98.62	
	24.78	24.80	24.60	24.60	98.78	
	24.65	24.65	24.65	24.65	98.60	
	24.65	24.65	24.65	24.15	98.10	
	24.15	24.15	24.15	24.15	96.60	
	24.15	24.15	24.15	24.35	96.80	
	24.35	24.35	24.35	24.35	97.40	
	23.40	23.40	23.50	23.50	93.80	
	23.50				23.50	AVG PER SECTION
				#	53	1298.99
Total	5,281.56	>	AVERAGE GRADE			
#	220		24.01			

OWNER: JOHN GALT, LLC
581 LAFAYETTE ROAD

CITY OF PORTSMOUTH
COUNTY OF ROCKINGHAM
STATE OF NEW HAMPSHIRE

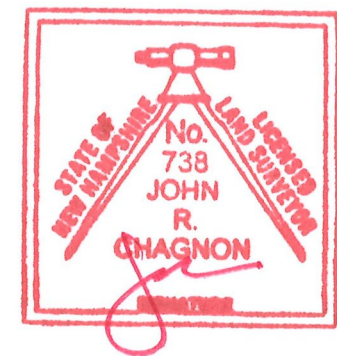
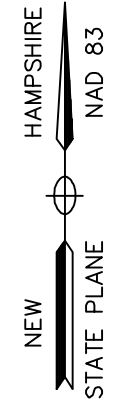
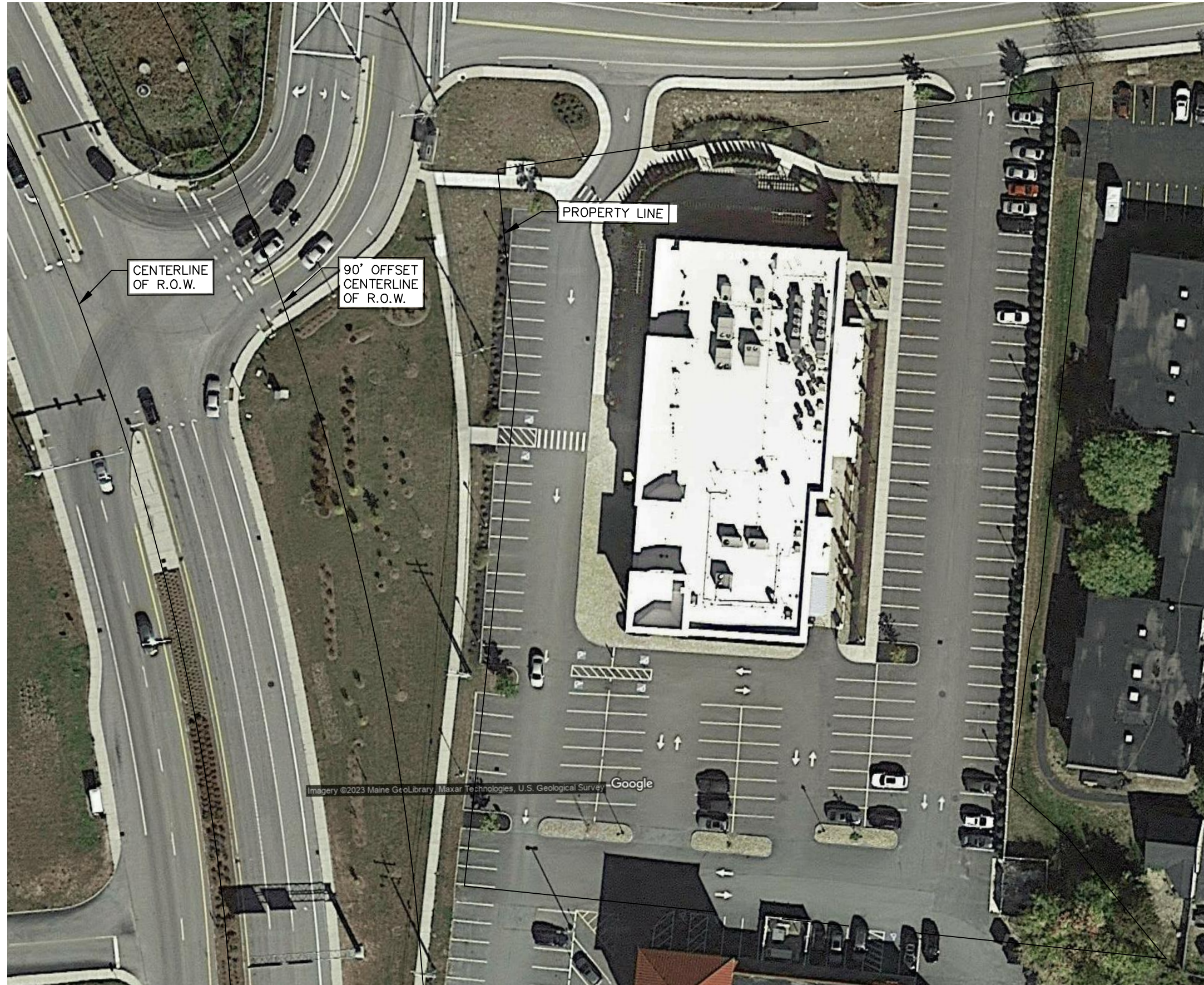

DEED REFERENCE: 6448/1309
PLAN REFERENCE: RCRD PLAN D-39349

1" = 50' 15 MARCH 2023



AMBIT ENGINEERING, INC.
Civil Engineers & Land Surveyors

200 Griffin Road - Unit 3
Portsmouth, N.H. 03801-7114
Tel (603) 430-9282
Fax (603) 436-2315

PAR. NO.	PROPERTY OWNER	TOTAL AREA OF PARCEL AC	AREA OF TAKE AC	REMAINDER		EASEMENTS					C.A.R.O.W. POINTS OF ACCESS		
				LEFT AC	RIGHT AC	PERMANENT		TEMPORARY			LT	RT	REV. NO.
						SF	TYPE	SF	DESCRIPTION	EXPIRES (MONTHS)			
10	BOURNIVAL, RICHARD D. JR.						SEE SHEET 8						
11	WILLIAM N. GENIMATAS REVOC. TRUST	4.74	0.02	-	4.72			1,050	DRIVE	JULY 2021 36 MONTHS			1
12	CROSS ROADS HOUSE INC. & SEACOAST HOUSING FOUNDATION INC.	1.83	-	1.83	-			1,875	DRIVE	JULY 2021 36 MONTHS			3
13	MANI PROPERTIES, LLC	2.25	-	-	2.25								

* DURATION OF TEMPORARY EASEMENTS WILL BE FOR 36 MONTHS UNLESS OTHERWISE NOTED - BEGINNING WITH THE COMMENCEMENT OF CONSTRUCTION ACTIVITIES.

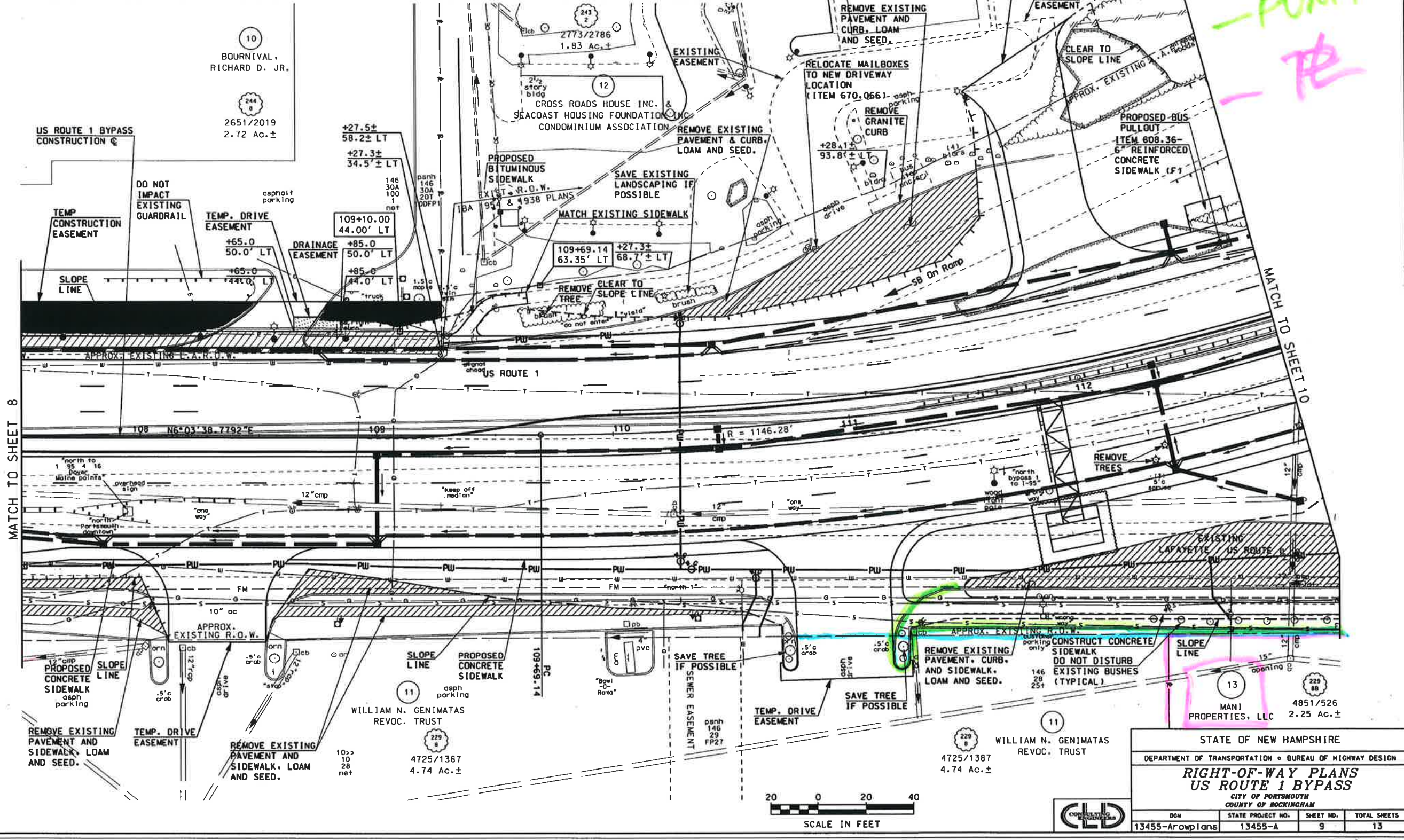

REVISIONS AFTER PROPOSAL	STATION	DESCRIPTION
	NUMBER	DATE
	DATE	DATE
	DATE	DATE

STATE OF NEW HAMPSHIRE
DEPARTMENT OF TRANSPORTATION • BUREAU OF HIGHWAY DESIGN

RIGHT-OF-WAY PLANS US ROUTE 1 BYPASS

CITY OF PORTSMOUTH
COUNTY OF ROCKINGHAM

DON	STATE PROJECT NO.	SHEET NO.	TOTAL SHEETS
13455-A-rows/ians	13455-A	9	13

CLD CONSULTING LAND DESIGN

REVISIONS AFTER PROPOSAL		STATION	DESCRIPTION
NO.	DATE		

DATE	DESCRIPTION	DATE	DESCRIPTION
7/27/2011	DATE	7/27/2011	DATE
7/27/2011	DATE	7/27/2011	DATE

DATE	DESCRIPTION	DATE	DESCRIPTION
7/27/2011	DATE	7/27/2011	DATE
7/27/2011	DATE	7/27/2011	DATE

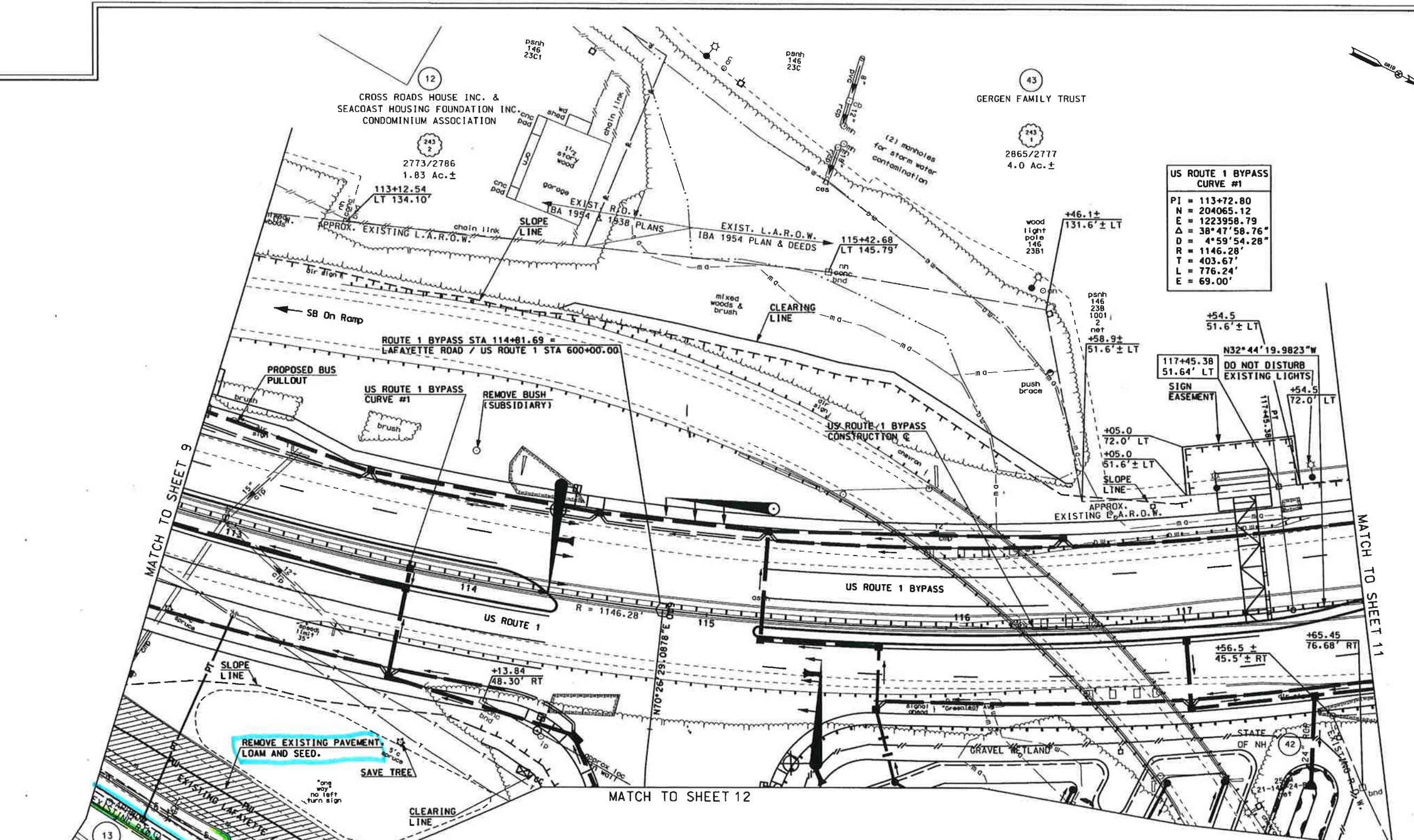

US ROUTE 1 BYPASS CURVE #1	
PI	= 113+72.80
N	= 204065.12
E	= 1223958.79
Δ	= 38°47'58.76"
D	= 4°59'54.28"
R	= 1146.28'
T	= 403.67'
L	= 776.24'
E	= 69.00'

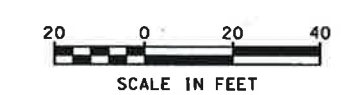

PAR. NO.	PROPERTY OWNER	TOTAL AREA OF PARCEL AC	AREA OF TAKE AC	REMAINDER		EASEMENTS				C.A.R.O.W. POINTS OF ACCESS				
				LEFT AC	RIGHT AC	PERMANENT SF	TYPE	TEMPORARY SF	DESCRIPTION	EXPIRES	LT	RT	REV. NO.	
12	CROSS ROADS HOUSE INC. & SEACOAST HOUSING FOUNDATION INC.						SEE SHEET 9							
13	MANI PROPERTIES, LLC						SEE SHEET 9							
42	STATE OF NH	0.48			0.48	200	DRAINAGE							
43	GERGEN FAMILY TRUST	4.00			4.00	6,800	SLOPE	60	BLOPE	JULY 2011				

* DURATION OF TEMPORARY EASEMENTS WILL BE FOR 36 MONTHS UNLESS OTHERWISE NOTED - BEGINNING WITH THE COMMENCEMENT OF CONSTRUCTION ACTIVITIES.

STATE OF NEW HAMPSHIRE
 DEPARTMENT OF TRANSPORTATION • BUREAU OF HIGHWAY DESIGN
RIGHT-OF-WAY PLANS
US ROUTE 1 BYPASS
 CITY OF PORTSMOUTH
 COUNTY OF ROCKINGHAM

DGN	STATE PROJECT NO.	SHEET NO.	TOTAL SHEETS
13455-A-00.plans	13455-A	10	13



SOR PROCESSED	DATE	7/27/2011	DATE	7/27/2011
	NEW DESIGN H/C		SHEET CHECKED	RD
	AS BUILT DETAILS			
REVISIONS AFTER PROPOSAL	NUMBER		STATION	
	DATE		DATE	

PAR. NO.	PROPERTY OWNER	TOTAL AREA OF PARCEL AC	AREA OF TAKE AC	REMAINDER		EASEMENTS					C.A.R.O.W. POINTS OF ACCESS			
				LEFT AC	RIGHT AC	8F	PERMANENT TYPE	8F	TEMPORARY DESCRIPTION	EXPIRES (DURATION)	LT	RT	REV. NO.	
13	MANI PROPERTIES, LLC													
13 A	RPL PROPERTIES, LLC	15.20	-	-	15.20									
14	CITY OF PORTSMOUTH	54.20	0.4	53.80	-	1,525	DRIVE ACCESS	4,500	SLOPE	JULY 2011				1
						1,225	DRAINAGE							
15	DOMER REALTY, LLC	0.96	-	0.96	-	780	SLOPE	300	DRIVE	JULY 2011				1
						975	CONSTRUCTION							
16	ST. NICHOLAS GREEK ORTHODOX CHURCH OF PORTSMOUTH, INC.	1.01	-	1.01	-									
42	STATE OF NH													

* DURATION OF TEMPORARY EASEMENTS WILL BE FOR 36 MONTHS UNLESS OTHERWISE NOTED - BEGINNING WITH THE COMMENCEMENT OF CONSTRUCTION ACTIVITIES.

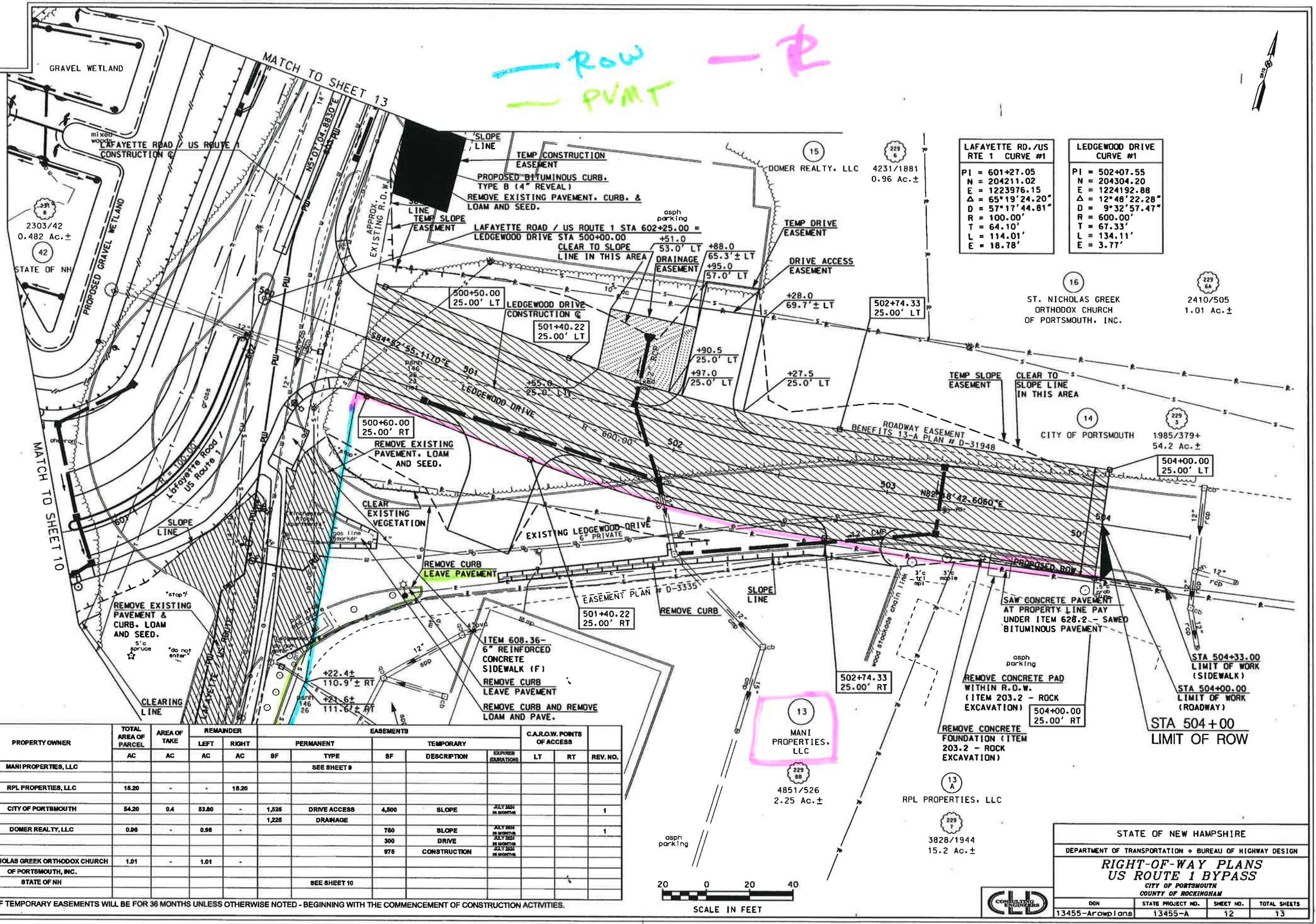

LAFAYETTE RD./US RTE 1 CURVE #1	LEDGEWOOD DRIVE CURVE #1
PI = 601+27.05	PI = 502+07.55
N = 204211.02	N = 204304.20
E = 1223976.15	E = 1224192.88
Δ = 65°19'24.20"	Δ = 12°48'22.28"
D = 57°17'44.81"	D = 9°32'57.47"
R = 100.00'	R = 600.00'
T = 64.10'	T = 67.33'
L = 114.01'	L = 134.11'
E = 18.78'	E = 3.77'

STATE OF NEW HAMPSHIRE
DEPARTMENT OF TRANSPORTATION • BUREAU OF HIGHWAY DESIGN
RIGHT-OF-WAY PLANS
US ROUTE 1 BYPASS
CITY OF PORTSMOUTH
COUNTY OF ROCKINGHAM

DGN	STATE PROJECT NO.	SHEET NO.	TOTAL SHEETS
13455-Arowplans	13455-A	12	13

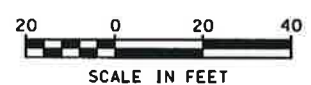

ABUTTERS ON WEST SIDE OF LAFAYETTE ROAD

N/F J.E. SHOLDAR, T.F. GERGEN JR., N.J. CZ/KE, R.E. GERGEN & J.M. GERGEN
155 GREENLEAF AVENUE
PORTSMOUTH, N.H. 03801
5495/1585

N/F CROSS ROADS HOUSE, INC.
600 LAFAYETTE ROAD
PORTSMOUTH, N.H. 03801
2773/2910

N/F OPERATION BLESSING, INC.
P.O. BOX 4069
PORTSMOUTH, N.H. 03802
3767/1721

AMBIT ENGINEERING, INC.
Civil Engineers & Land Surveyors
200 Griffin Road, Unit 3
Portsmouth, N.H. 03801-7114
Tel (603) 430-9202
Fax (603) 436-2315

- NOTES:**
- 1) PARCEL IS SHOWN ON THE CITY OF PORTSMOUTH ASSESSOR'S MAP 229 AS LOT 8B.
 - 2) OWNERS OF RECORD:
DMJ REALTY, LLC
63 MAIN STREET
PO BOX 1195
SALEM, N.H. 03079
5669/0667
 - 3) THE PARCEL IS NOT IN A FLOOD HAZARD ZONE AS SHOWN ON FIRM PANEL 33015C0270E, EFFECTIVE MAY 17, 2005
 - 4) EXISTING LOT AREA:
98,124 S.F.
2,2526 AC
 - 5) PARCEL IS LOCATED IN THE GATEWAY (GW) DISTRICT.
 - 6) DIMENSIONAL REQUIREMENTS:
MIN. LOT AREA: 43,560 S.F.
FRONTAGE: 200 FT.
DEPTH: 100 FT.
SETBACKS: FRONT: 30 FT.
SIDE: 30 FT.
REAR: 50 FT.
MAXIMUM STRUCTURE HEIGHT: 40 FT.
MAXIMUM ROOF APPURTENANCE HEIGHT: 10 FT.
MAXIMUM BUILDING COVERAGE: 30%
MINIMUM OPEN SPACE: 20%
 - 7) THE PURPOSE OF THIS PLAN IS TO SHOW THE EXISTING CONDITIONS ON TAX MAP 229 LOT 8B.
 - 8) EASEMENTS & RESTRICTIONS:
A) ROAD/UTILITY EASEMENT AREA: SEE C-3316 AND RCRD 2110/428 AND 2184/184. THIS EASEMENT WAS PARTIALLY TERMINATED ON 11/9/15: SEE RCRD 5689/0645.
B) 30' RIGHT OF WAY: SEE D-8806 AND 5446/2589.
C) MUTUAL PARKING AND ACCESS RIGHTS FOR LOTS 1-3 ON PLAN D-8806 ARE OF RECORD, RCRD 2343/128 AND 5446/2588.

POW
PUMT

**SITE REDEVELOPMENT
TUSCAN KITCHEN
581 LAFAYETTE ROAD
PORTSMOUTH, N.H.**

3	REVISED NOTES 2 AND 8	12/21/15
2	ADDED HANDICAP PARKING	8/26/15
1	ADDED EXISTING FORCE MAIN	7/30/15
0	ISSUED FOR COMMENT	7/20/15
NO.	DESCRIPTION	DATE



SCALE: 1" = 30' JULY 2015

EXISTING CONDITIONS PLAN **C1**

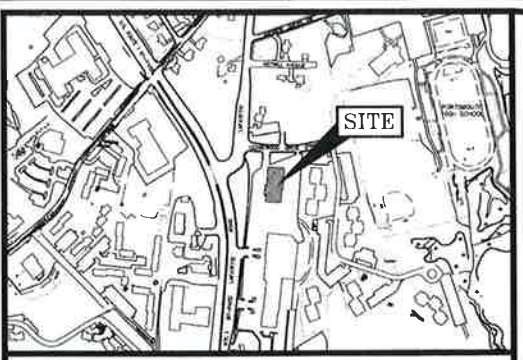

LOCATION MAP SCALE: 1" = 400'±

LEGEND:

EXISTING	PROPOSED	
FM	FM	FORCE MAIN
S	S	SEWER LINE
G	G	GAS LINE
D	D	STORM DRAIN
SPP	SPP	SMOOTH PLASTIC PIPE
W	W	WATER LINE
UE	UE	UNDERGROUND ELECTRIC
UU	UU	UNDERGROUND UTILITIES
OE	OE	OVERHEAD ELECTRIC WIRES
100	100	CONTOUR
97x3	98x0	SPOT ELEVATION
		EDGE OF PAVEMENT (EP)
		WOODS / TREE LINE
		UTILITY POLE
		WATER SHUT OFF/CURB STOP
		GAS SHUT OFF
		GATE VALVE
		HYDRANT
		METER (GAS, WATER, ELECTRIC)
		CATCH BASIN
		TELEPHONE MANHOLE
		SEWER MANHOLE
		DRAIN MANHOLE
		WELL
		EDGE OF WETLAND FLAGGING
		SWAMP/ MARSH
		ASBESTOS CEMENT PIPE
		CAST IRON PIPE
		CORRUGATED METAL PIPE
		CONCRETE MASONRY UNIT
		DUCTILE IRON PIPE
		POLYVINYL CHLORIDE PIPE
		REINFORCED CONCRETE PIPE
		VITRIFIED CLAY PIPE
		ELEVATION
		EP
		FF
		INV
		TBM
		TYP
		VGC/SGC
		CCB
		CL
		IR/CAP FND
		NHHD
		P

LENGTH TABLE

LINE	BEARING	DISTANCE
L1	S15°17'27"W	14.20'
L2	S48°43'16"E	33.26'

EASEMENT LENGTH TABLE

LINE	BEARING	DISTANCE
L3	N05°54'49"E	1.69'
L4	S05°56'03"W	10.32'
L5	S58°58'49"W	10.88'

EASEMENT CURVE TABLE

CURVE	RADIUS	ARC LENGTH	CHORD LENGTH	CHORD BEARING	DELTA ANGLE
C1	50.00'	52.60'	50.20'	S36°02'43"W	60°16'11"

LAFAYETTE
U.S. ROUTE 1

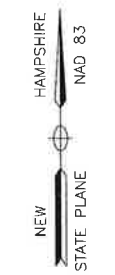
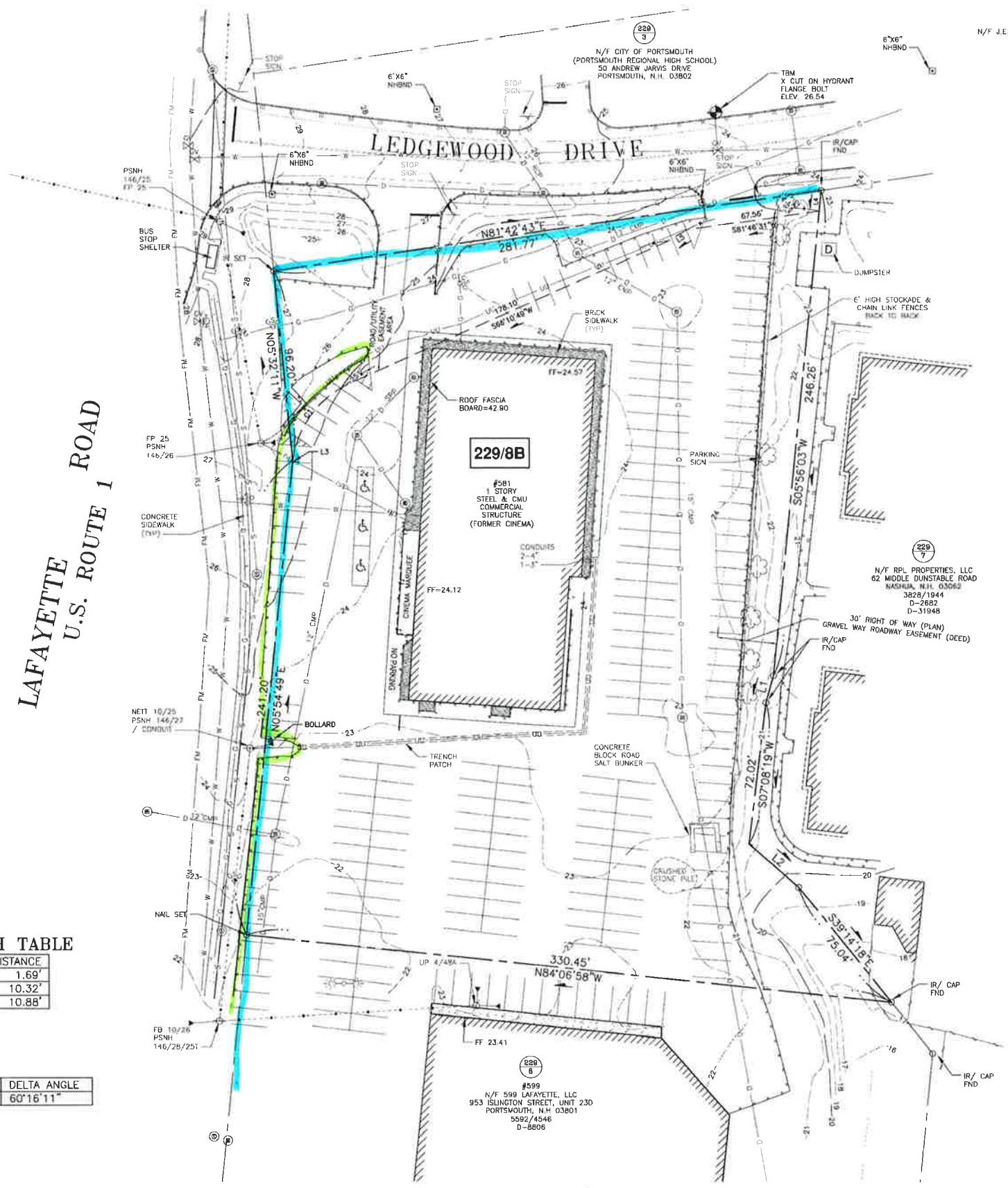

APPROVED BY THE PORTSMOUTH PLANNING BOARD

CHAIRMAN _____ DATE _____



Jellyfish Design Calculation

CONTECH Stormwater Solutions Inc. Engineer
Date Prepared:

JBS
11/20/2023

Site Information

Project Name **581 Lafayette Road**
Project State **NH**
Project City **Portsmouth**

Total Drainage Area, Ad **2.94** ac
Post Development Impervious Area, Ai **1.77** ac
Pervious Area, Ap **1.18** ac
% Impervious **60%**
Runoff Coefficient, Rc **0.59**
Upstream pretreatment credit **0%**

Mass Loading Calculations

Mean Annual Rainfall, P **50.0** in
Agency Required % Removal **80%**
Percent Runoff Capture **90%**
Mean Annual Runoff, Vt **283,494** ft³
Event Mean Concentration of Pollutant, EMC **45** mg/l
Annual Mass Load, M total **796** lbs

Filter System

Filtration Brand **Jelly Fish**
Cartridge Length **54** in

Jelly Fish Sizing

Mass removed by pretreatment system **0** lbs
Mass load to filters after pretreatment **796** lbs
Mass to be Captured by System **637** lbs
Water Quality Flow **0.82** cfs

Method to Use

FLOW BASED

Summary			
Flow	Required Size	JFPD0806-5-1	54
	Treatment Flow Rate provided:		0.98 cfs

DRAINAGE ANALYSIS

COMMERCIAL DEVELOPMENT

581 LAFAYETTE ROAD
PORTSMOUTH, NH

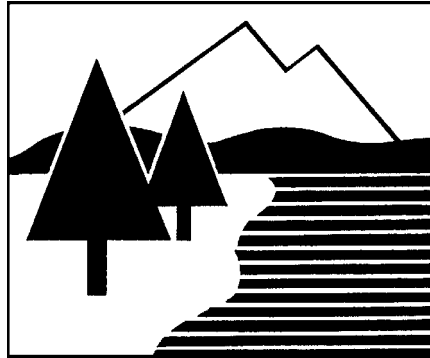

PREPARED FOR
ATLAS COMMONS, LLC

20 NOVEMBER 2023

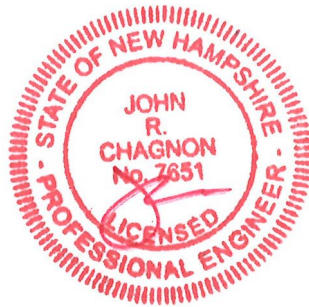

200 Griffin Road, Unit 3
Portsmouth, NH 03801
Phone: 603.430.9282; Fax: 603.436.2315
E-mail: jchagnon@haleyward.com
(Ambit Job Number 5010156.1397.03)

TABLE OF CONTENTS***REPORT***

Executive Summary	1
Introduction / Project Description	2
Methodology	2
Site Specific Information	3
Pre-Development Drainage	4
Post-Development Drainage	4
Offsite Infrastructure Capacity	6
Erosion and Sediment Control Practices	6
Conclusion	7
References	7

ATTACHMENTS

Existing Subcatchment Plan	
Proposed Subcatchment Plan	

APPENDIX

Vicinity (Tax) Map	A
Tables, Charts, Etc.	B
HydroCAD Drainage Analysis Calculations	C
Soil Survey Information	D
FEMA FIRM Map	E
Inspection & Long Term Maintenance Plan	F

EXECUTIVE SUMMARY

This drainage analysis examines the pre-development (existing) and post-development (proposed) stormwater drainage patterns for the Commercial Development at the property known as 581 Lafayette Road in Portsmouth, NH. The site is shown on the City of Portsmouth Assessor's Tax Map 229 as Lot 8B. The total size of the associated drainage area is 188,901± square-feet (4.337 acres). The total size of the lot is 98,125± square-feet (2.253 acres). The total redevelopment area of the project is 66,540± square-feet (1.528 acres).

The development will provide for a new commercial building with associated parking and utilities. The development has the potential to increase stormwater pollutants to City infrastructure, and therefore must be designed in a manner to prevent that occurrence. This will be done primarily by capturing stormwater runoff and routing it through appropriate stormwater facilities, designed to ensure that there will be no increase in pollutants from the site as a result of this project.

The hydrologic modeling utilized for this analysis uses the "Extreme Precipitation" values for rainfall from The Northeast Regional Climate Center (Cornell University), with a 15% increase to comply with local ordinance.

The proposed development includes a Contech Jellyfish® Filter in order to treat stormwater from the site, in compliance with local ordinance.

INTRODUCTION / PROJECT DESCRIPTION

This drainage report is designed to assist the owner, contractor, regulatory reviewer, and others in understanding the impact of the proposed development project on local surface water runoff and quality. The project site is shown on the City of Portsmouth, NH Assessor's Tax Map 229 as Lot 8B. Bounding the site to the north is Ledgewood Drive. Bounding the site to the east is apartments. Bounding the site to the South is commercial development. Bounding the site to the west is Lafayette Road (Route 1). A vicinity map is included in the Appendix to this report.

The proposed development will include a residential building addition with utilities and associated parking. This report includes information about the existing site and the proposed additions necessary to analyze stormwater runoff and to design any required mitigation. The report includes maps of pre-development and post-development watersheds, subcatchment areas and calculations of runoff. The report will provide a narrative of the stormwater runoff and describe numerically and graphically the surface water runoff patterns for this site. Proposed stormwater management methods will also be described, as well as erosion and sediment control practices. To fully understand the proposed site development the reader should also review a complete site plan set in addition to this report.

METHODOLOGY

"Extreme Precipitation" values from The Northeast Regional Climate Center (Cornell University) have been used for modeling purposes. These values have been used in this analysis, with a 15% addition to comply with local ordinances. The unadjusted table is appended to this report.

This report uses the US Soil Conservation Service (SCS) Method for estimating stormwater runoff. The SCS method is published in The National Engineering Handbook (NEH), Section 4 "Hydrology" and includes the Technical Release No. 20, (TR-20) "Computer Program for Project Formulation Hydrology", and Technical Release No. 55 (TR-55) "Urban Hydrology for Small Watersheds" methods. This report uses the HydroCAD version 10.20 program,

written by HydroCAD Software Solutions LLC, Chocorua, N.H., to apply these methods for the calculation of runoff and for pond modeling. Rainfall data and runoff curve numbers are taken from “The Stormwater Management and Erosion Control Handbook for Urban and Developing Areas in New Hampshire.”

Time of Concentration (Tc) is calculated by entering measured flow path data such as flow path type, length, slope and surface characteristics into the HydroCAD program. For the purposes of this report, a minimum time of concentration of 5 minutes is used.

The storm events used for the calculations in this report are the 2-year, 10-year, 25-year, and 50-year (24-hour) storms. Watershed basin boundaries have been delineated using topographic maps prepared by Haley Ward and field observations to confirm.

SITE SPECIFIC INFORMATION

Based on the United States Department of Agriculture (USDA) Natural Resources Conservation Service (NRCS), Soil Survey of Rockingham County, New Hampshire the site is made up of two soil types:

Soil Symbol	Soil Name and Slopes
699	Urban Land
799	Urban land – Canton complex, 3 to 15 percent slopes

Urban Land does not have any recorded geological features, including depth to bedrock or depth to water table. The Hydraulic Soil Grade is assumed to be type A.

The physical characteristics of the site not containing buildings consist of gently sloped (0-15%) grades that generally slope from the northwest of the lot to the southeast. Elevations on the site range from 17 to 27 feet above sea level. The existing site is developed with commercial buildings and associated parking.

According to the Federal Emergency Management Agency (FEMA) Flood Insurance Rate Map (FIRM) number 33015C0270F (effective date January 29, 2021), the proposed

development is located in Zone X and is determined to be outside of the 0.2% annual chance floodplain. A copy of the FIRM map is included in the Appendix.

PRE-DEVELOPMENT DRAINAGE

In the pre-development condition, the site has been analyzed as nine subcatchment basins (E1a, E1b, E1c, E2a, E2b, E2c, E2d, E3, and O1) based on localized topography and discharge location. Subcatchments E1a, E1b, and E1c contain the west half of the lot, and flow to the southwest corner through an existing drainage network to discharge point DP1. Subcatchments E2a, E2b, E2c, and E2d flow through an existing drainage network to the southeast corner of the property to discharge point DP2. Subcatchment E3 represents overland flow in the southeast corner of the lot to discharge point DP2. Subcatchment O1 represents off-site flow that ultimately flows to DP2 through the existing drainage network.

Table 1: Pre-Development Watershed Basin Summary

Watershed Basin ID	Basin Area (SF)	Tc (MIN)	CN	10-Year Runoff (CFS)	50-Year Runoff (CFS)	To Design Point
E1a	20,120	5.0	77	1.77	3.20	DP1
E1b	27,062	5.0	92	3.34	5.23	DP1
E1c	4,032	5.0	98	0.53	0.80	DP1
E2a	8,301	5.0	64	0.45	0.97	DP2
E2b	16,660	5.0	91	2.02	3.20	DP2
E2c	16,042	5.0	93	2.01	3.12	DP2
E2d	7,341	5.0	95	0.94	1.45	DP2
E3	9,577	5.0	57	0.35	0.89	DP2
O1	79,768	27.6	65	2.53	5.43	DP2

POST-DEVELOPMENT DRAINAGE

The proposed development has been designed to match the pre-development drainage patterns to the greatest extent feasible. In the post-development condition, the site has been analyzed as nine subcatchment basins, (P1a, P1b, P1c, P2a, P2b, P2c, P2d, P3, O1). All

subcatchments occupy approximately the same location as their existing counterparts and drain to the same drainage points. This is intentional and will be a function of the roof design for the additions.

Table 2: Post-Development Watershed Basin Summary

Watershed Basin ID	Basin Area (SF)	Tc (MIN)	CN	10-Year Runoff (CFS)	50-Year Runoff (CFS)	To Design Point
P1a	20,120	5.0	77	1.77	3.20	DP1
P1b	26,173	5.0	94	3.31	5.13	DP1
P1c	4,594	5.0	98	0.60	0.92	DP1
P2a	8,300	5.0	57	0.30	0.77	DP2
P2b	16,660	5.0	92	2.05	3.22	DP2
P2c	15,044	5.0	98	1.97	3.00	DP2
P2d	8,407	5.0	98	1.10	1.67	DP2
P3	9,835	5.0	71	0.71	1.38	DP2
O1	79,768	27.6	65	2.53	5.43	DP2

The overall impervious coverage of the subcatchment areas analyzed in this report **increases** from 2.768 acres (63.9%) in the pre-development condition to 2.861 acres (66.0%) in the post-development condition. The City of Portsmouth specifies that 30% of existing impervious cover in addition to 100% of additional proposed impervious cover is treated in a Redevelopment project. These conditions are exceeded by treating 77,475 sf of impervious surface with a Contech Jellyfish filter.

$$(100\%)(4,012 \text{ sf impervious}) + (30\%)(81,351 \text{ sf impervious}) = 28,417 \text{ sf required treatment}$$

Table 3 shows a summary of the comparison between pre-developed flows and post-developed flows for the design point. The comparison shows increased flows between the existing and proposed conditions due to the increase in impervious surfaces on the site.

Table 3: Pre-Development to Post-Development Comparison

Design Point	Q2 (CFS)		Q10 (CFS)		Q50 (CFS)		Description
	Pre	Post	Pre	Post	Pre	Post	
DP1	3.29	3.37	5.63	5.68	9.24	9.24	Drainage System 1
DP2	3.50	3.83	6.59	6.96	11.76	12.18	Drainage System 2

Note that all post-development peak discharges are either equivalent or greater than the existing peak discharges.

OFFSITE INFRASTRUCTURE CAPACITY

Due to the change of impervious surfaces in the proposed plan, the impacts to the local infrastructure receptors were considered. The receiving catch basin has a 12" diameter and was likely designed for a 10-year storm event with a less stringent design storm. The current design standards would have one of the receiving catch basins (CB1 in the plan set) overflow in the 10-year storm event. However, due to the minimal increase in flow in the proposed design, it is anticipated that the receiving catch basin will not experience significant additional inundation. As a result, it is anticipated that the proposed design will have minimal impact on City infrastructure.

EROSION AND SEDIMENT CONTROL PRACTICES

The erosion potential for this site as it exists is moderate due to the presence of existing impervious surfaces. During construction, the major potential for erosion is wind and stormwater runoff. The contractor will be required to inspect and maintain all necessary erosion control measures, as well as installing any additional measures as required. All erosion control practices shall conform to "The Stormwater Management and Erosion Control Handbook for Urban and Developing Areas in New Hampshire." Some examples of erosion and sediment control measures to be utilized for this project during construction may include:

- Catch basin filter baskets
- Stabilized construction entrance at access point to the site (FODS)
- Temporary mulching and seeding for disturbed areas
- Spraying water over disturbed areas to minimize wind erosion

After construction, permanent stabilization will be accomplished by surfacing the access drives and walkways as shown on the plans.

CONCLUSION

The proposed development has been designed to match the pre-development drainage patterns to the greatest extent feasible. With the design of the Contech Jellyfish filter, the post-development runoff is treated sufficiently. Erosion and sediment control practices will be implemented for both the temporary condition during construction and for final stabilization after construction. Therefore, there are no negative impacts to downstream receptors or adjacent properties anticipated as a result of this project.

REFERENCES

1. Comprehensive Environmental Inc. and New Hampshire Department of Environmental Services. *New Hampshire Stormwater Manual (Volumes 1, 2 and 3)*, December 2008 (Revision 1.0).
2. Minnick, E.L. and H.T. Marshall. *Stormwater Management and Erosion and Sediment Control Handbook for Urban and Developing Areas in New Hampshire*, prepared by Rockingham County Conservation District, prepared for New Hampshire Department of Environmental Services, in cooperation with USDA Soil Conservation Service, August 1992.
3. HydroCAD Software Solution, LLC. *HydroCAD Stormwater Modeling System Version 10.20* copyright 2022.

COMMERCIAL DEVELOPMENT
581 LAFAYETTE ROAD
PORTSMOUTH, NH

JOB NUMBER: 5010156.1397.04
SCALE: 1" = 80'
SUBMITTED: 11-20-2023

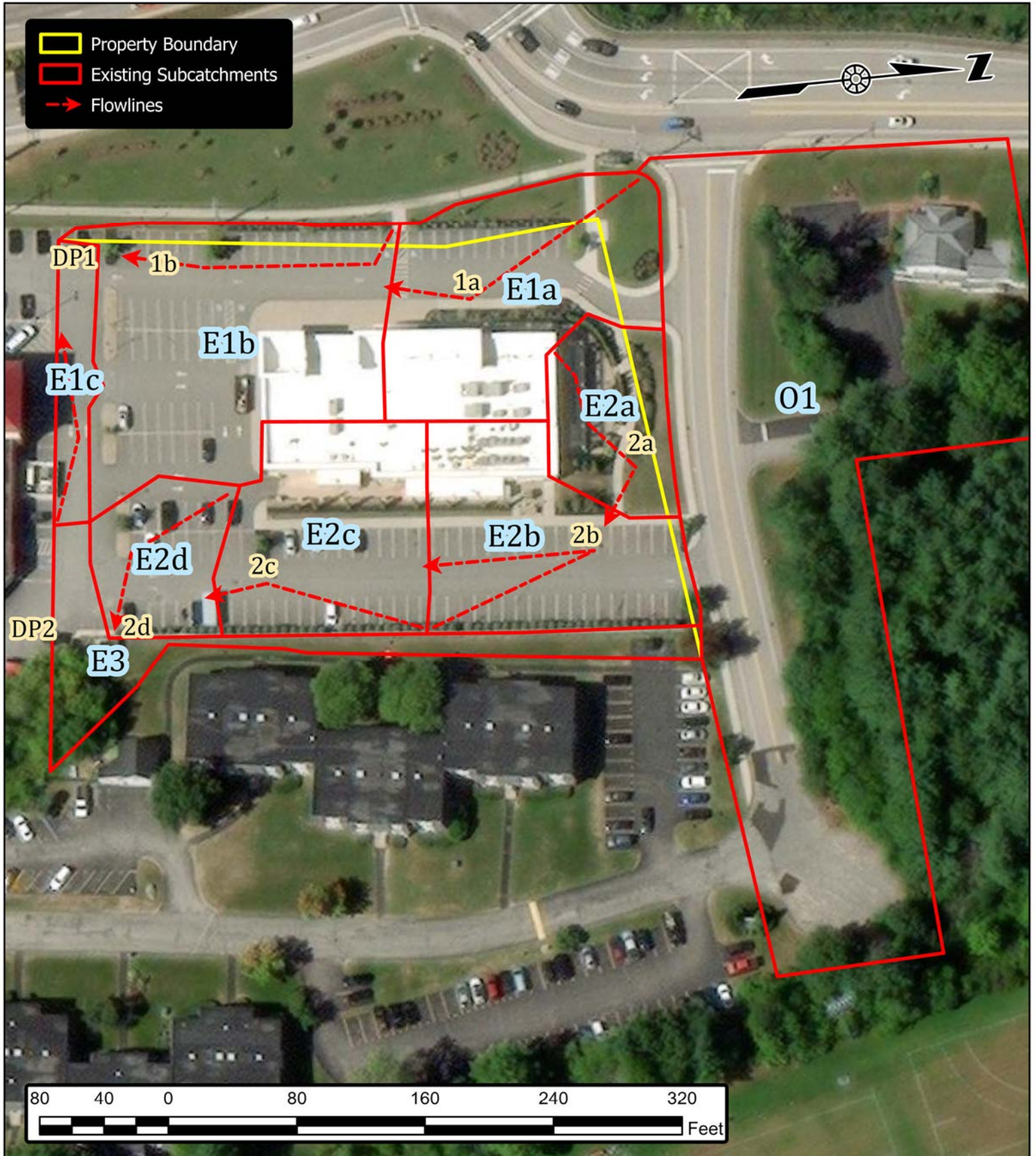

COMMERCIAL DEVELOPMENT
581 LAFAYETTE ROAD
PORTSMOUTH, NH

JOB NUMBER: 5010156.1397.04
SCALE: 1" = 80'
SUBMITTED: 11-20-2023

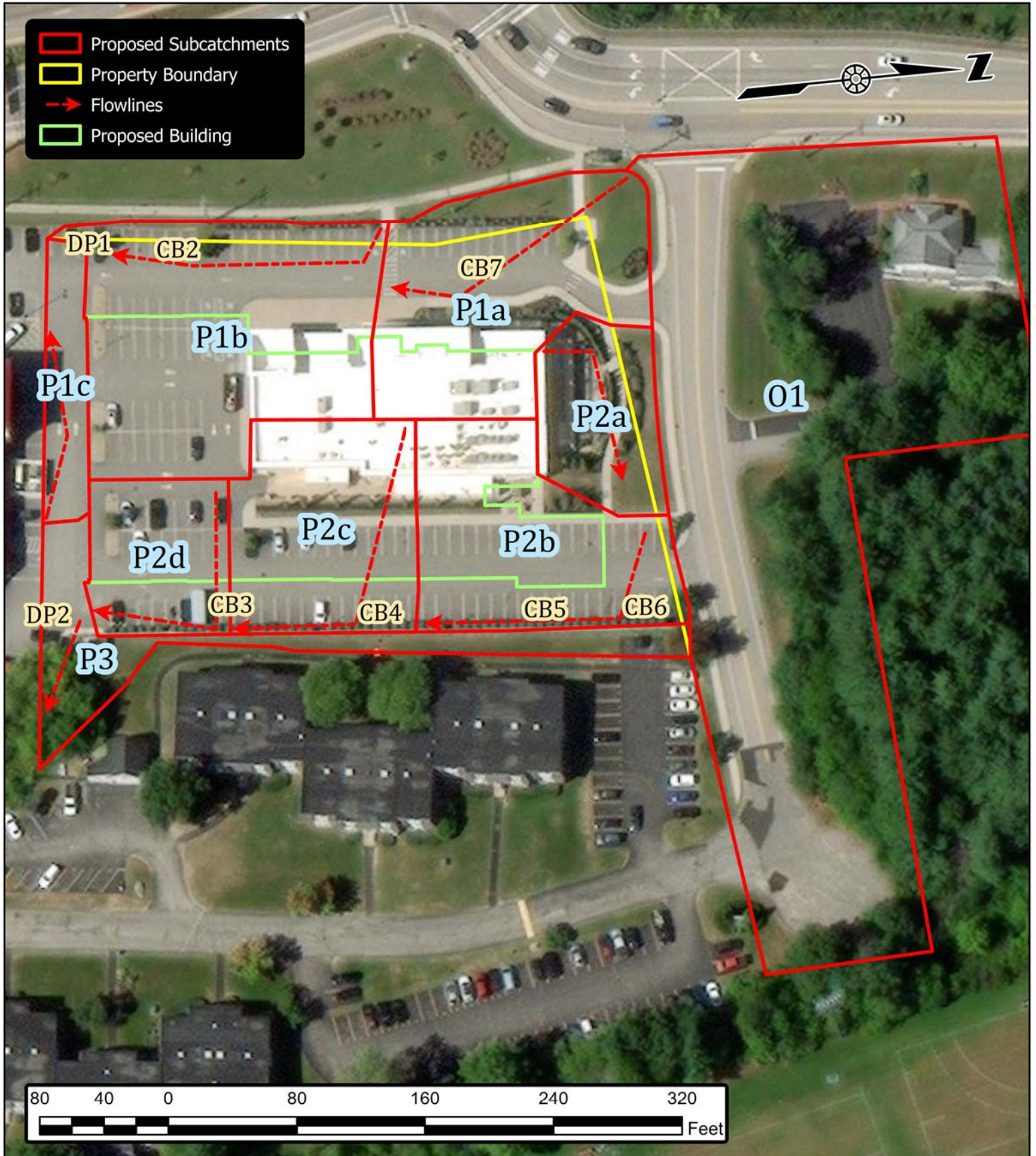

APPENDIX A
VICINITY (TAX) MAP

COMMERCIAL DEVELOPMENT
581 LAFAYETTE ROAD
PORTSMOUTH, NH

JOB NUMBER: 5010156.1397.04
SCALE: 1" = 100'
SUBMITTED: 09-19-2023

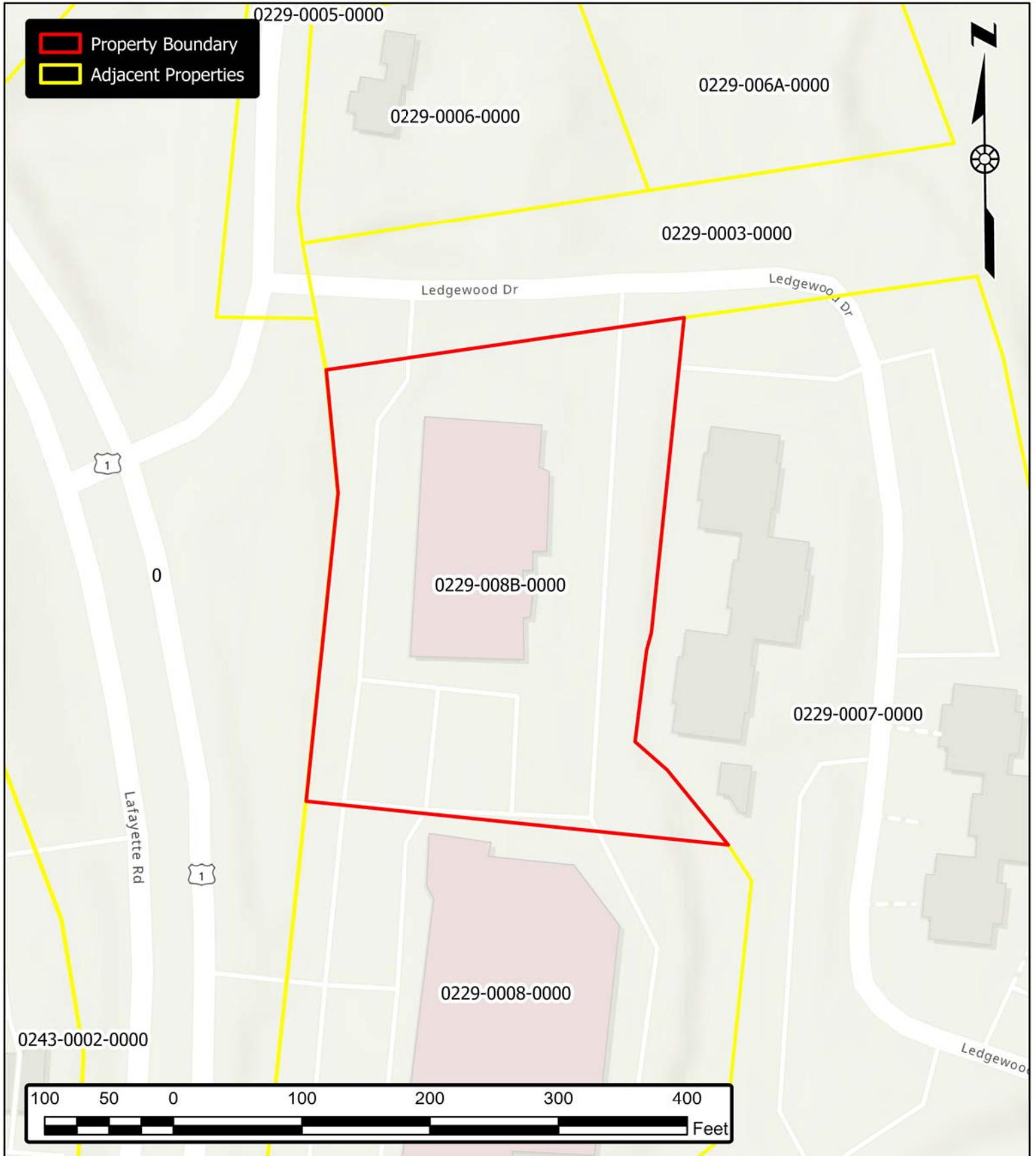

APPENDIX B
TABLES, CHARTS, ETC.

COMMERCIAL DEVELOPMENT
581 LAFAYETTE ROAD
PORTSMOUTH, NH

JOB NUMBER: 5010156.1397.04
SCALE: 1" = 60'
SUBMITTED: 09-19-2023

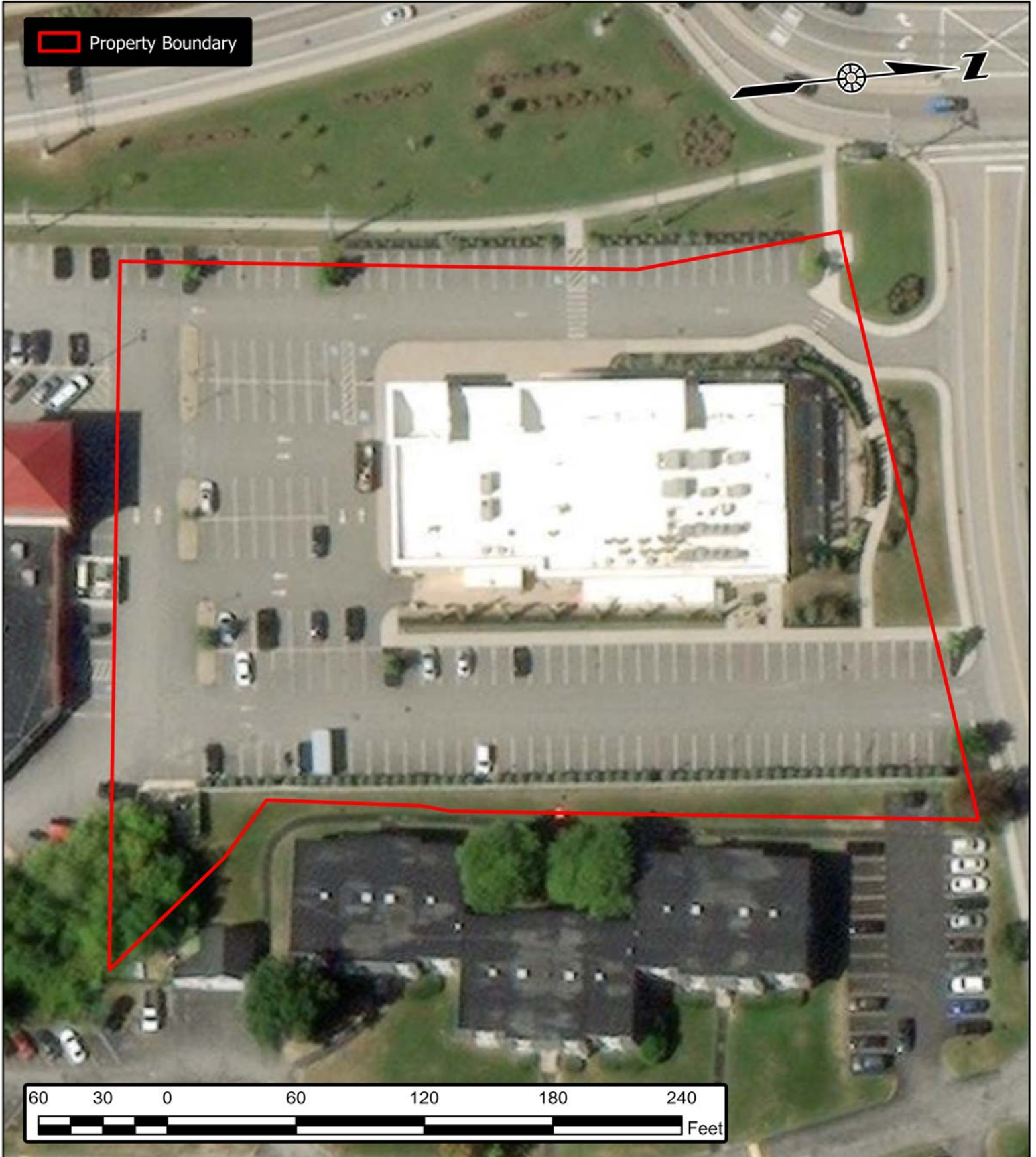

Extreme Precipitation Tables

Northeast Regional Climate Center

Data represents point estimates calculated from partial duration series. All precipitation amounts are displayed in inches.

Metadata for Point	
Smoothing	Yes
State	
Location	
Latitude	43.057 degrees North
Longitude	70.769 degrees West
Elevation	0 feet
Date/Time	Tue Sep 19 2023 09:52:18 GMT-0400 (Eastern Daylight Time)

Extreme Precipitation Estimates

	5min	10min	15min	30min	60min	120min		1hr	2hr	3hr	6hr	12hr	24hr	48hr		1day	2day	4day	7day	10day	
1yr	0.26	0.40	0.50	0.65	0.82	1.04	1yr	0.70	0.98	1.21	1.57	2.04	2.67	2.93	1yr	2.36	2.82	3.23	3.96	4.57	1yr
2yr	0.32	0.50	0.62	0.82	1.02	1.30	2yr	0.88	1.18	1.52	1.94	2.50	3.22	3.58	2yr	2.85	3.45	3.95	4.70	5.35	2yr
5yr	0.37	0.58	0.73	0.98	1.25	1.61	5yr	1.08	1.47	1.89	2.44	3.15	4.08	4.60	5yr	3.61	4.42	5.06	5.96	6.73	5yr
10yr	0.41	0.65	0.82	1.12	1.45	1.89	10yr	1.25	1.73	2.24	2.90	3.76	4.89	5.55	10yr	4.33	5.34	6.11	7.14	8.01	10yr
25yr	0.48	0.76	0.97	1.34	1.78	2.34	25yr	1.53	2.15	2.78	3.64	4.76	6.20	7.13	25yr	5.49	6.86	7.85	9.07	10.10	25yr
50yr	0.54	0.86	1.10	1.54	2.08	2.76	50yr	1.79	2.53	3.30	4.34	5.68	7.42	8.62	50yr	6.57	8.29	9.48	10.87	12.03	50yr
100yr	0.60	0.97	1.25	1.78	2.42	3.27	100yr	2.09	2.99	3.92	5.18	6.80	8.90	10.43	100yr	7.87	10.03	11.46	13.04	14.35	100yr
200yr	0.68	1.10	1.43	2.05	2.83	3.85	200yr	2.45	3.53	4.63	6.15	8.12	10.66	12.61	200yr	9.44	12.13	13.85	15.64	17.11	200yr
500yr	0.80	1.32	1.72	2.49	3.49	4.78	500yr	3.01	4.39	5.79	7.74	10.27	13.55	16.22	500yr	11.99	15.60	17.81	19.91	21.61	500yr

Lower Confidence Limits

	5min	10min	15min	30min	60min	120min		1hr	2hr	3hr	6hr	12hr	24hr	48hr		1day	2day	4day	7day	10day	
1yr	0.23	0.36	0.44	0.59	0.72	0.88	1yr	0.63	0.87	0.92	1.33	1.68	2.25	2.53	1yr	1.99	2.43	2.88	3.18	3.91	1yr
2yr	0.32	0.49	0.60	0.81	1.00	1.19	2yr	0.86	1.16	1.37	1.82	2.34	3.07	3.47	2yr	2.72	3.34	3.84	4.57	5.10	2yr
5yr	0.35	0.54	0.67	0.92	1.17	1.40	5yr	1.01	1.37	1.61	2.12	2.73	3.81	4.22	5yr	3.37	4.06	4.74	5.57	6.28	5yr
10yr	0.39	0.59	0.74	1.03	1.33	1.60	10yr	1.15	1.57	1.81	2.39	3.06	4.40	4.90	10yr	3.89	4.71	5.49	6.46	7.24	10yr
25yr	0.44	0.67	0.83	1.19	1.57	1.90	25yr	1.35	1.86	2.10	2.75	3.53	4.75	5.95	25yr	4.20	5.72	6.72	7.87	8.75	25yr
50yr	0.48	0.74	0.92	1.32	1.77	2.17	50yr	1.53	2.12	2.35	3.07	3.93	5.37	6.88	50yr	4.75	6.61	7.83	9.14	10.11	50yr
100yr	0.54	0.81	1.02	1.47	2.02	2.47	100yr	1.74	2.42	2.63	3.41	4.35	6.04	7.95	100yr	5.35	7.65	9.12	10.64	11.68	100yr
200yr	0.60	0.90	1.14	1.64	2.29	2.82	200yr	1.98	2.76	2.94	3.77	4.79	6.78	9.19	200yr	6.00	8.84	10.63	12.40	13.51	200yr
500yr	0.69	1.03	1.32	1.92	2.73	3.37	500yr	2.36	3.30	3.42	4.30	5.45	7.90	11.13	500yr	7.00	10.70	13.00	15.20	16.37	500yr

Upper Confidence Limits

	5min	10min	15min	30min	60min	120min		1hr	2hr	3hr	6hr	12hr	24hr	48hr		1day	2day	4day	7day	10day	
1yr	0.29	0.44	0.54	0.72	0.89	1.09	1yr	0.77	1.06	1.26	1.74	2.20	2.99	3.17	1yr	2.65	3.05	3.60	4.39	5.06	1yr
2yr	0.34	0.52	0.64	0.87	1.07	1.27	2yr	0.92	1.24	1.48	1.96	2.51	3.44	3.71	2yr	3.04	3.57	4.10	4.85	5.65	2yr
5yr	0.40	0.62	0.77	1.05	1.34	1.62	5yr	1.15	1.59	1.88	2.53	3.25	4.36	4.97	5yr	3.85	4.78	5.40	6.39	7.17	5yr
10yr	0.47	0.72	0.89	1.25	1.61	1.98	10yr	1.39	1.93	2.28	3.11	3.95	5.36	6.21	10yr	4.74	5.97	6.82	7.85	8.77	10yr
25yr	0.58	0.88	1.09	1.56	2.05	2.57	25yr	1.77	2.52	2.95	4.07	5.15	7.80	8.34	25yr	6.90	8.02	9.13	10.35	11.42	25yr
50yr	0.67	1.02	1.27	1.83	2.47	3.13	50yr	2.13	3.06	3.60	5.00	6.31	9.76	10.44	50yr	8.64	10.04	11.41	12.73	13.97	50yr
100yr	0.79	1.20	1.50	2.16	2.97	3.82	100yr	2.56	3.73	4.37	6.15	7.75	12.21	13.07	100yr	10.81	12.57	14.24	15.70	17.09	100yr
200yr	0.93	1.39	1.76	2.55	3.56	4.66	200yr	3.07	4.56	5.34	7.58	9.52	15.32	16.38	200yr	13.56	15.75	17.81	19.34	20.91	200yr
500yr	1.15	1.71	2.20	3.20	4.54	6.05	500yr	3.92	5.92	6.93	10.02	12.53	20.69	22.08	500yr	18.31	21.23	23.93	25.48	27.32	500yr



COMMERCIAL DEVELOPMENT
581 LAFAYETTE ROAD
PORTSMOUTH, NH

JOB NUMBER: 5010156.1397.04
SCALE: 1" = 2,000'
SUBMITTED: 09-19-2023

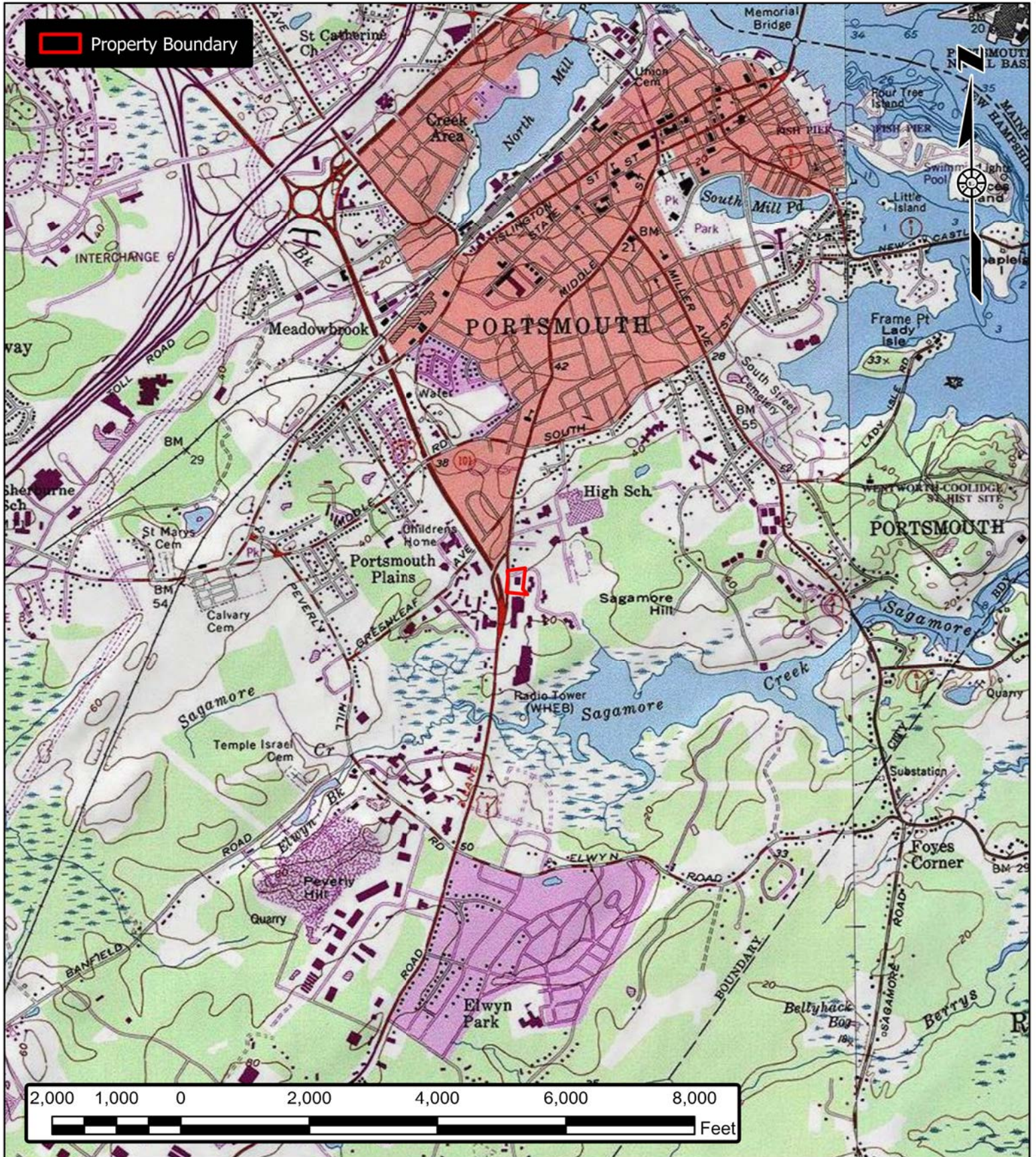

APPENDIX C
HYDROCAD DRAINAGE
ANALYSIS CALCULATIONS

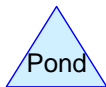
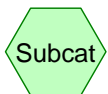
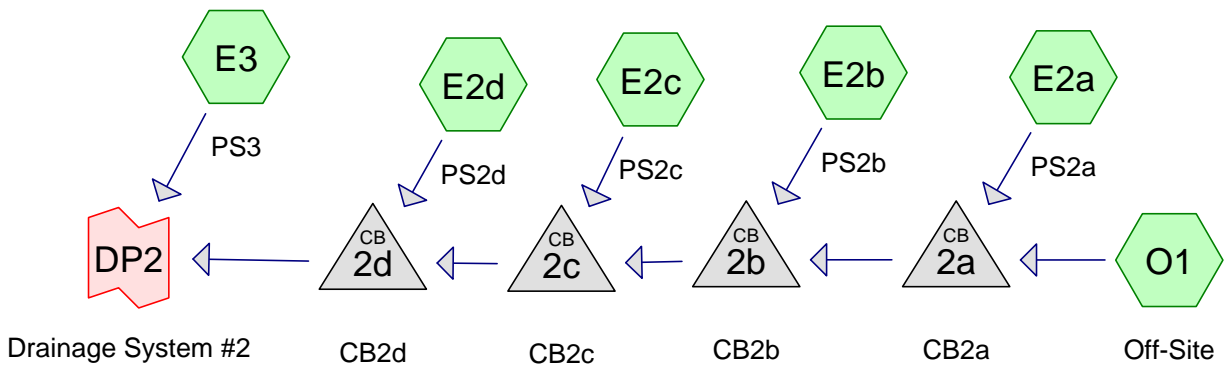
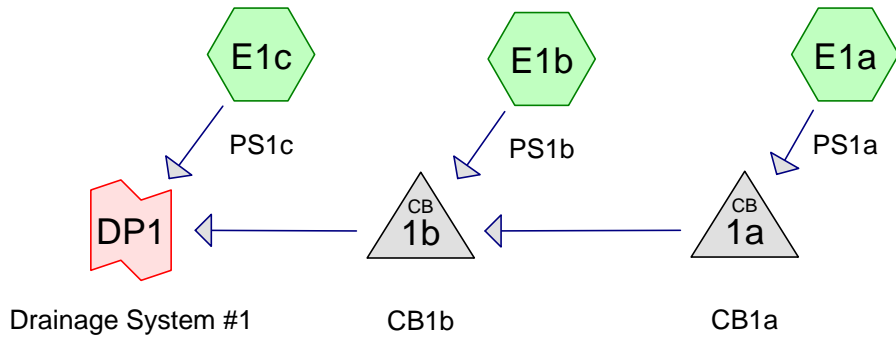

Project Notes

Defined 5 rainfall events from extreme_precip_tables_output IDF

Existing Conditions 2015-09-24

Prepared by Haley Ward

HydroCAD® 10.20-3g s/n 00801 © 2023 HydroCAD Software Solutions LLC

Printed 11/17/2023

Page 3

Rainfall Events Listing (selected events)

Event#	Event Name	Storm Type	Curve	Mode	Duration (hours)	B/B	Depth (inches)	AMC
1	2-yr	Type III 24-hr		Default	24.00	1	3.70	2
2	10-yr	Type III 24-hr		Default	24.00	1	5.62	2
3	25-yr	Type III 24-hr		Default	24.00	1	7.13	2
4	50-yr	Type III 24-hr		Default	24.00	1	8.53	2

Existing Conditions 2015-09-24

Prepared by Haley Ward

HydroCAD® 10.20-3g s/n 00801 © 2023 HydroCAD Software Solutions LLC

Printed 11/17/2023

Page 4

Area Listing (all nodes)

Area (sq-ft)	CN	Description (subcatchment-numbers)
46,242	39	>75% Grass cover, Good, HSG A (E1a, E1b, E1c, E2a, E2b, E2c, E2d, E3, O1)
102,162	98	Paved parking, HSG A (E1a, E1b, E1c, E2a, E2b, E2c, E2d, E3, O1)
15,994	98	Roofs, HSG A (E1a, E1b, E2a, E2b, E2c)
2,453	98	Unconnected roofs, HSG A (O1)
22,052	36	Woods, Fair, HSG A (O1)
188,903	76	TOTAL AREA

Existing Conditions 2015-09-24

Prepared by Haley Ward

HydroCAD® 10.20-3g s/n 00801 © 2023 HydroCAD Software Solutions LLC

Printed 11/17/2023

Page 5

Soil Listing (all nodes)

Area (sq-ft)	Soil Group	Subcatchment Numbers
188,903	HSG A	E1a, E1b, E1c, E2a, E2b, E2c, E2d, E3, O1
0	HSG B	
0	HSG C	
0	HSG D	
0	Other	
188,903		TOTAL AREA

Existing Conditions 2015-09-24

Prepared by Haley Ward

HydroCAD® 10.20-3g s/n 00801 © 2023 HydroCAD Software Solutions LLC

Printed 11/17/2023

Page 6

Ground Covers (all nodes)

HSG-A (sq-ft)	HSG-B (sq-ft)	HSG-C (sq-ft)	HSG-D (sq-ft)	Other (sq-ft)	Total (sq-ft)	Ground Cover	Sub Num
46,242	0	0	0	0	46,242	>75% Grass cover, Good	
102,162	0	0	0	0	102,162	Paved parking	
15,994	0	0	0	0	15,994	Roofs	
2,453	0	0	0	0	2,453	Unconnected roofs	
22,052	0	0	0	0	22,052	Woods, Fair	
188,903	0	0	0	0	188,903	TOTAL AREA	

Existing Conditions 2015-09-24

Prepared by Haley Ward

HydroCAD® 10.20-3g s/n 00801 © 2023 HydroCAD Software Solutions LLC

Printed 11/17/2023

Page 7

Pipe Listing (all nodes)

Line#	Node Number	In-Invert (feet)	Out-Invert (feet)	Length (feet)	Slope (ft/ft)	n	Width (inches)	Diam/Height (inches)	Inside-Fill (inches)	Node Name
1	O1	0.00	0.00	110.0	0.0050	0.015	0.0	12.0	0.0	
2	1a	20.49	17.94	203.0	0.0126	0.025	0.0	12.0	0.0	
3	1b	17.69	14.69	200.0	0.0150	0.025	0.0	15.0	0.0	
4	2a	18.94	18.94	54.0	0.0000	0.025	0.0	12.0	0.0	
5	2b	18.34	17.78	200.0	0.0028	0.025	0.0	15.0	0.0	
6	2c	17.80	12.18	375.0	0.0150	0.025	0.0	15.0	0.0	
7	2d	17.29	16.79	100.0	0.0050	0.025	0.0	15.0	0.0	

Existing Conditions 2015-09-24

Type III 24-hr 2-yr Rainfall=3.70"

Prepared by Haley Ward

Printed 11/17/2023

HydroCAD® 10.20-3g s/n 00801 © 2023 HydroCAD Software Solutions LLC

Page 8

Time span=0.00-48.00 hrs, dt=0.01 hrs, 4801 points
 Runoff by SCS TR-20 method, UH=SCS, Weighted-CN
 Reach routing by Stor-Ind+Trans method - Pond routing by Stor-Ind method

Subcatchment E1a: PS1a	Runoff Area=20,120 sf 65.08% Impervious Runoff Depth=1.58" Tc=5.0 min CN=77 Runoff=0.88 cfs 2,650 cf
Subcatchment E1b: PS1b	Runoff Area=27,062 sf 89.28% Impervious Runoff Depth=2.83" Tc=5.0 min CN=92 Runoff=2.07 cfs 6,379 cf
Subcatchment E1c: PS1c	Runoff Area=4,032 sf 99.58% Impervious Runoff Depth=3.47" Tc=5.0 min CN=98 Runoff=0.35 cfs 1,165 cf
Subcatchment E2a: PS2a	Runoff Area=8,301 sf 41.78% Impervious Runoff Depth=0.81" Tc=5.0 min CN=64 Runoff=0.16 cfs 559 cf
Subcatchment E2b: PS2b	Runoff Area=16,660 sf 87.98% Impervious Runoff Depth=2.73" Tc=5.0 min CN=91 Runoff=1.24 cfs 3,792 cf
Subcatchment E2c: PS2c	Runoff Area=16,042 sf 92.13% Impervious Runoff Depth=2.93" Tc=5.0 min CN=93 Runoff=1.26 cfs 3,915 cf
Subcatchment E2d: PS2d	Runoff Area=7,341 sf 95.70% Impervious Runoff Depth=3.14" Tc=5.0 min CN=95 Runoff=0.60 cfs 1,918 cf
Subcatchment E3: PS3	Runoff Area=9,577 sf 29.98% Impervious Runoff Depth=0.49" Tc=5.0 min CN=57 Runoff=0.08 cfs 394 cf
Subcatchment O1: Off-Site	Runoff Area=79,768 sf 45.80% Impervious Runoff Depth=0.86" Flow Length=584' Tc=27.6 min CN=65 Runoff=0.93 cfs 5,712 cf
Pond 1a: CB1a	Peak Elev=21.09' Inflow=0.88 cfs 2,650 cf 12.0" Round Culvert n=0.025 L=203.0' S=0.0126 '/' Outflow=0.88 cfs 2,650 cf
Pond 1b: CB1b	Peak Elev=18.74' Inflow=2.94 cfs 9,029 cf 15.0" Round Culvert n=0.025 L=200.0' S=0.0150 '/' Outflow=2.94 cfs 9,029 cf
Pond 2a: CB2a	Peak Elev=19.94' Inflow=1.00 cfs 6,271 cf 12.0" Round Culvert n=0.025 L=54.0' S=0.0000 '/' Outflow=1.00 cfs 6,271 cf
Pond 2b: CB2b	Peak Elev=19.43' Inflow=1.58 cfs 10,063 cf 15.0" Round Culvert n=0.025 L=200.0' S=0.0028 '/' Outflow=1.58 cfs 10,063 cf
Pond 2c: CB2c	Peak Elev=18.82' Inflow=2.83 cfs 13,977 cf 15.0" Round Culvert n=0.025 L=375.0' S=0.0150 '/' Outflow=2.83 cfs 13,977 cf
Pond 2d: CB2d	Peak Elev=19.27' Inflow=3.43 cfs 15,896 cf 15.0" Round Culvert n=0.025 L=100.0' S=0.0050 '/' Outflow=3.43 cfs 15,896 cf
Link DP1: Drainage System #1	Inflow=3.29 cfs 10,194 cf Primary=3.29 cfs 10,194 cf

Existing Conditions 2015-09-24

Prepared by Haley Ward

HydroCAD® 10.20-3g s/n 00801 © 2023 HydroCAD Software Solutions LLC

Type III 24-hr 2-yr Rainfall=3.70"

Printed 11/17/2023

Page 9

Link DP2: Drainage System #2

Inflow=3.50 cfs 16,289 cf

Primary=3.50 cfs 16,289 cf

Total Runoff Area = 188,903 sf Runoff Volume = 26,483 cf Average Runoff Depth = 1.68"
36.15% Pervious = 68,294 sf 63.85% Impervious = 120,609 sf

Existing Conditions 2015-09-24

Type III 24-hr 2-yr Rainfall=3.70"

Prepared by Haley Ward

Printed 11/17/2023

HydroCAD® 10.20-3g s/n 00801 © 2023 HydroCAD Software Solutions LLC

Page 10

Summary for Subcatchment E1a: PS1a

Runoff = 0.88 cfs @ 12.08 hrs, Volume= 2,650 cf, Depth= 1.58"
Routed to Pond 1a : CB1a

Runoff by SCS TR-20 method, UH=SCS, Weighted-CN, Time Span= 0.00-48.00 hrs, dt= 0.01 hrs
Type III 24-hr 2-yr Rainfall=3.70"

Area (sf)	CN	Description
4,566	98	Roofs, HSG A
7,025	39	>75% Grass cover, Good, HSG A
8,529	98	Paved parking, HSG A
20,120	77	Weighted Average
7,025		34.92% Pervious Area
13,095		65.08% Impervious Area

Tc (min)	Length (feet)	Slope (ft/ft)	Velocity (ft/sec)	Capacity (cfs)	Description
5.0					Direct Entry,

Summary for Subcatchment E1b: PS1b

Runoff = 2.07 cfs @ 12.07 hrs, Volume= 6,379 cf, Depth= 2.83"
Routed to Pond 1b : CB1b

Runoff by SCS TR-20 method, UH=SCS, Weighted-CN, Time Span= 0.00-48.00 hrs, dt= 0.01 hrs
Type III 24-hr 2-yr Rainfall=3.70"

Area (sf)	CN	Description
2,901	39	>75% Grass cover, Good, HSG A
3,319	98	Roofs, HSG A
20,842	98	Paved parking, HSG A
27,062	92	Weighted Average
2,901		10.72% Pervious Area
24,161		89.28% Impervious Area

Tc (min)	Length (feet)	Slope (ft/ft)	Velocity (ft/sec)	Capacity (cfs)	Description
5.0					Direct Entry,

Summary for Subcatchment E1c: PS1c

Runoff = 0.35 cfs @ 12.07 hrs, Volume= 1,165 cf, Depth= 3.47"
Routed to Link DP1 : Drainage System #1

Runoff by SCS TR-20 method, UH=SCS, Weighted-CN, Time Span= 0.00-48.00 hrs, dt= 0.01 hrs
Type III 24-hr 2-yr Rainfall=3.70"

Existing Conditions 2015-09-24

Type III 24-hr 2-yr Rainfall=3.70"

Prepared by Haley Ward

Printed 11/17/2023

HydroCAD® 10.20-3g s/n 00801 © 2023 HydroCAD Software Solutions LLC

Page 11

Area (sf)	CN	Description
17	39	>75% Grass cover, Good, HSG A
4,015	98	Paved parking, HSG A
4,032	98	Weighted Average
17		0.42% Pervious Area
4,015		99.58% Impervious Area

Tc (min)	Length (feet)	Slope (ft/ft)	Velocity (ft/sec)	Capacity (cfs)	Description
5.0					Direct Entry,

Summary for Subcatchment E2a: PS2a

Runoff = 0.16 cfs @ 12.09 hrs, Volume= 559 cf, Depth= 0.81"
 Routed to Pond 2a : CB2a

Runoff by SCS TR-20 method, UH=SCS, Weighted-CN, Time Span= 0.00-48.00 hrs, dt= 0.01 hrs
 Type III 24-hr 2-yr Rainfall=3.70"

Area (sf)	CN	Description
56	98	Roofs, HSG A
4,833	39	>75% Grass cover, Good, HSG A
3,412	98	Paved parking, HSG A
8,301	64	Weighted Average
4,833		58.22% Pervious Area
3,468		41.78% Impervious Area

Tc (min)	Length (feet)	Slope (ft/ft)	Velocity (ft/sec)	Capacity (cfs)	Description
5.0					Direct Entry,

Summary for Subcatchment E2b: PS2b

Runoff = 1.24 cfs @ 12.07 hrs, Volume= 3,792 cf, Depth= 2.73"
 Routed to Pond 2b : CB2b

Runoff by SCS TR-20 method, UH=SCS, Weighted-CN, Time Span= 0.00-48.00 hrs, dt= 0.01 hrs
 Type III 24-hr 2-yr Rainfall=3.70"

Area (sf)	CN	Description
3,630	98	Roofs, HSG A
2,003	39	>75% Grass cover, Good, HSG A
11,027	98	Paved parking, HSG A
16,660	91	Weighted Average
2,003		12.02% Pervious Area
14,657		87.98% Impervious Area

Existing Conditions 2015-09-24

Type III 24-hr 2-yr Rainfall=3.70"

Prepared by Haley Ward

Printed 11/17/2023

HydroCAD® 10.20-3g s/n 00801 © 2023 HydroCAD Software Solutions LLC

Page 12

Tc (min)	Length (feet)	Slope (ft/ft)	Velocity (ft/sec)	Capacity (cfs)	Description
5.0					Direct Entry,

Summary for Subcatchment E2c: PS2c

Runoff = 1.26 cfs @ 12.07 hrs, Volume= 3,915 cf, Depth= 2.93"
Routed to Pond 2c : CB2c

Runoff by SCS TR-20 method, UH=SCS, Weighted-CN, Time Span= 0.00-48.00 hrs, dt= 0.01 hrs
Type III 24-hr 2-yr Rainfall=3.70"

Area (sf)	CN	Description
4,423	98	Roofs, HSG A
1,262	39	>75% Grass cover, Good, HSG A
10,357	98	Paved parking, HSG A
16,042	93	Weighted Average
1,262		7.87% Pervious Area
14,780		92.13% Impervious Area

Tc (min)	Length (feet)	Slope (ft/ft)	Velocity (ft/sec)	Capacity (cfs)	Description
5.0					Direct Entry,

Summary for Subcatchment E2d: PS2d

Runoff = 0.60 cfs @ 12.07 hrs, Volume= 1,918 cf, Depth= 3.14"
Routed to Pond 2d : CB2d

Runoff by SCS TR-20 method, UH=SCS, Weighted-CN, Time Span= 0.00-48.00 hrs, dt= 0.01 hrs
Type III 24-hr 2-yr Rainfall=3.70"

Area (sf)	CN	Description
316	39	>75% Grass cover, Good, HSG A
7,025	98	Paved parking, HSG A
7,341	95	Weighted Average
316		4.30% Pervious Area
7,025		95.70% Impervious Area

Tc (min)	Length (feet)	Slope (ft/ft)	Velocity (ft/sec)	Capacity (cfs)	Description
5.0					Direct Entry,

Summary for Subcatchment E3: PS3

Runoff = 0.08 cfs @ 12.11 hrs, Volume= 394 cf, Depth= 0.49"
Routed to Link DP2 : Drainage System #2

Runoff by SCS TR-20 method, UH=SCS, Weighted-CN, Time Span= 0.00-48.00 hrs, dt= 0.01 hrs
Type III 24-hr 2-yr Rainfall=3.70"

Existing Conditions 2015-09-24

Type III 24-hr 2-yr Rainfall=3.70"

Prepared by Haley Ward

Printed 11/17/2023

HydroCAD® 10.20-3g s/n 00801 © 2023 HydroCAD Software Solutions LLC

Page 13

Area (sf)	CN	Description
6,706	39	>75% Grass cover, Good, HSG A
2,871	98	Paved parking, HSG A
9,577	57	Weighted Average
6,706		70.02% Pervious Area
2,871		29.98% Impervious Area

Tc (min)	Length (feet)	Slope (ft/ft)	Velocity (ft/sec)	Capacity (cfs)	Description
5.0					Direct Entry,

Summary for Subcatchment O1: Off-Site

Runoff = 0.93 cfs @ 12.45 hrs, Volume= 5,712 cf, Depth= 0.86"
 Routed to Pond 2a : CB2a

Runoff by SCS TR-20 method, UH=SCS, Weighted-CN, Time Span= 0.00-48.00 hrs, dt= 0.01 hrs
 Type III 24-hr 2-yr Rainfall=3.70"

Area (sf)	CN	Description
2,453	98	Unconnected roofs, HSG A
34,084	98	Paved parking, HSG A
22,052	36	Woods, Fair, HSG A
21,179	39	>75% Grass cover, Good, HSG A
79,768	65	Weighted Average
43,231		54.20% Pervious Area
36,537		45.80% Impervious Area
2,453		6.71% Unconnected

Tc (min)	Length (feet)	Slope (ft/ft)	Velocity (ft/sec)	Capacity (cfs)	Description
19.6	100	0.0250	0.08		Sheet Flow, Woods: Light underbrush n= 0.400 P2= 3.20"
7.3	374	0.0150	0.86		Shallow Concentrated Flow, Short Grass Pasture Kv= 7.0 fps
0.7	110	0.0050	2.78	2.18	Pipe Channel, RCP_Round 12" 12.0" Round Area= 0.8 sf Perim= 3.1' r= 0.25' n= 0.015 Concrete sewer w/manholes & inlets
27.6	584	Total			

Summary for Pond 1a: CB1a

[57] Hint: Peaked at 21.09' (Flood elevation advised)

Inflow Area = 20,120 sf, 65.08% Impervious, Inflow Depth = 1.58" for 2-yr event
 Inflow = 0.88 cfs @ 12.08 hrs, Volume= 2,650 cf
 Outflow = 0.88 cfs @ 12.08 hrs, Volume= 2,650 cf, Atten= 0%, Lag= 0.0 min
 Primary = 0.88 cfs @ 12.08 hrs, Volume= 2,650 cf
 Routed to Pond 1b : CB1b

Existing Conditions 2015-09-24

Prepared by Haley Ward

HydroCAD® 10.20-3g s/n 00801 © 2023 HydroCAD Software Solutions LLC

Type III 24-hr 2-yr Rainfall=3.70"

Printed 11/17/2023

Page 14

Routing by Stor-Ind method, Time Span= 0.00-48.00 hrs, dt= 0.01 hrs
Peak Elev= 21.09' @ 12.08 hrs

Device	Routing	Invert	Outlet Devices
#1	Primary	20.49'	12.0" Round CMP_Round 12" L= 203.0' CMP, square edge headwall, Ke= 0.500 Inlet / Outlet Invert= 20.49' / 17.94' S= 0.0126 '/ Cc= 0.900 n= 0.025 Corrugated metal, Flow Area= 0.79 sf

Primary OutFlow Max=0.88 cfs @ 12.08 hrs HW=21.09' (Free Discharge)

↑1=CMP_Round 12" (Barrel Controls 0.88 cfs @ 2.53 fps)

Summary for Pond 1b: CB1b

[57] Hint: Peaked at 18.74' (Flood elevation advised)

[79] Warning: Submerged Pond 1a Primary device # 1 OUTLET by 0.80'

Inflow Area = 47,182 sf, 78.96% Impervious, Inflow Depth = 2.30" for 2-yr event
Inflow = 2.94 cfs @ 12.07 hrs, Volume= 9,029 cf
Outflow = 2.94 cfs @ 12.07 hrs, Volume= 9,029 cf, Atten= 0%, Lag= 0.0 min
Primary = 2.94 cfs @ 12.07 hrs, Volume= 9,029 cf
Routed to Link DP1 : Drainage System #1

Routing by Stor-Ind method, Time Span= 0.00-48.00 hrs, dt= 0.01 hrs
Peak Elev= 18.74' @ 12.07 hrs

Device	Routing	Invert	Outlet Devices
#1	Primary	17.69'	15.0" Round CMP_Round 15" L= 200.0' CMP, square edge headwall, Ke= 0.500 Inlet / Outlet Invert= 17.69' / 14.69' S= 0.0150 '/ Cc= 0.900 n= 0.025 Corrugated metal, Flow Area= 1.23 sf

Primary OutFlow Max=2.94 cfs @ 12.07 hrs HW=18.74' (Free Discharge)

↑1=CMP_Round 15" (Barrel Controls 2.94 cfs @ 3.62 fps)

Summary for Pond 2a: CB2a

[57] Hint: Peaked at 19.94' (Flood elevation advised)

Inflow Area = 88,069 sf, 45.42% Impervious, Inflow Depth = 0.85" for 2-yr event
Inflow = 1.00 cfs @ 12.42 hrs, Volume= 6,271 cf
Outflow = 1.00 cfs @ 12.42 hrs, Volume= 6,271 cf, Atten= 0%, Lag= 0.0 min
Primary = 1.00 cfs @ 12.42 hrs, Volume= 6,271 cf
Routed to Pond 2b : CB2b

Routing by Stor-Ind method, Time Span= 0.00-48.00 hrs, dt= 0.01 hrs
Peak Elev= 19.94' @ 12.42 hrs

Device	Routing	Invert	Outlet Devices
#1	Primary	18.94'	12.0" Round CMP_Round 12" L= 54.0' CMP, square edge headwall, Ke= 0.500

Existing Conditions 2015-09-24

Type III 24-hr 2-yr Rainfall=3.70"

Prepared by Haley Ward

Printed 11/17/2023

HydroCAD® 10.20-3g s/n 00801 © 2023 HydroCAD Software Solutions LLC

Page 15

Inlet / Outlet Invert= 18.94' / 18.94' S= 0.0000 '/ n= 0.025 Corrugated metal, Flow Area= 0.79 sf Cc= 0.900

Primary OutFlow Max=1.00 cfs @ 12.42 hrs HW=19.93' (Free Discharge)

↑1=CMP_Round 12" (Barrel Controls 1.00 cfs @ 1.58 fps)

Summary for Pond 2b: CB2b

[57] Hint: Peaked at 19.43' (Flood elevation advised)

[79] Warning: Submerged Pond 2a Primary device # 1 by 0.49'

Inflow Area = 104,729 sf, 52.19% Impervious, Inflow Depth = 1.15" for 2-yr event
Inflow = 1.58 cfs @ 12.08 hrs, Volume= 10,063 cf
Outflow = 1.58 cfs @ 12.08 hrs, Volume= 10,063 cf, Atten= 0%, Lag= 0.0 min
Primary = 1.58 cfs @ 12.08 hrs, Volume= 10,063 cf
Routed to Pond 2c : CB2c

Routing by Stor-Ind method, Time Span= 0.00-48.00 hrs, dt= 0.01 hrs
Peak Elev= 19.43' @ 12.08 hrs

Device	Routing	Invert	Outlet Devices
#1	Primary	18.34'	15.0" Round CMP_Round 15" L= 200.0' CMP, square edge headwall, Ke= 0.500 Inlet / Outlet Invert= 18.34' / 17.78' S= 0.0028 '/ n= 0.025 Corrugated metal, Flow Area= 1.23 sf Cc= 0.900

Primary OutFlow Max=1.58 cfs @ 12.08 hrs HW=19.43' (Free Discharge)

↑1=CMP_Round 15" (Barrel Controls 1.58 cfs @ 1.85 fps)

Summary for Pond 2c: CB2c

[57] Hint: Peaked at 18.82' (Flood elevation advised)

[79] Warning: Submerged Pond 2b Primary device # 1 INLET by 0.48'

Inflow Area = 120,771 sf, 57.50% Impervious, Inflow Depth = 1.39" for 2-yr event
Inflow = 2.83 cfs @ 12.08 hrs, Volume= 13,977 cf
Outflow = 2.83 cfs @ 12.08 hrs, Volume= 13,977 cf, Atten= 0%, Lag= 0.0 min
Primary = 2.83 cfs @ 12.08 hrs, Volume= 13,977 cf
Routed to Pond 2d : CB2d

Routing by Stor-Ind method, Time Span= 0.00-48.00 hrs, dt= 0.01 hrs
Peak Elev= 18.82' @ 12.08 hrs

Device	Routing	Invert	Outlet Devices
#1	Primary	17.80'	15.0" Round CMP_Round 15" L= 375.0' CMP, square edge headwall, Ke= 0.500 Inlet / Outlet Invert= 17.80' / 12.18' S= 0.0150 '/ n= 0.025 Corrugated metal, Flow Area= 1.23 sf Cc= 0.900

Primary OutFlow Max=2.83 cfs @ 12.08 hrs HW=18.82' (Free Discharge)

↑1=CMP_Round 15" (Barrel Controls 2.83 cfs @ 3.60 fps)

Summary for Pond 2d: CB2d

[57] Hint: Peaked at 19.27' (Flood elevation advised)
 [81] Warning: Exceeded Pond 2c by 0.45' @ 12.07 hrs

Inflow Area = 128,112 sf, 59.69% Impervious, Inflow Depth = 1.49" for 2-yr event
 Inflow = 3.43 cfs @ 12.07 hrs, Volume= 15,896 cf
 Outflow = 3.43 cfs @ 12.07 hrs, Volume= 15,896 cf, Atten= 0%, Lag= 0.0 min
 Primary = 3.43 cfs @ 12.07 hrs, Volume= 15,896 cf
 Routed to Link DP2 : Drainage System #2

Routing by Stor-Ind method, Time Span= 0.00-48.00 hrs, dt= 0.01 hrs
 Peak Elev= 19.27' @ 12.07 hrs

Device	Routing	Invert	Outlet Devices
#1	Primary	17.29'	15.0" Round CMP_Round 15" L= 100.0' CMP, square edge headwall, Ke= 0.500 Inlet / Outlet Invert= 17.29' / 16.79' S= 0.0050 '/ Cc= 0.900 n= 0.025 Corrugated metal, Flow Area= 1.23 sf

Primary OutFlow Max=3.42 cfs @ 12.07 hrs HW=19.26' (Free Discharge)
 ↳ **1=CMP_Round 15"** (Barrel Controls 3.42 cfs @ 2.79 fps)

Summary for Link DP1: Drainage System #1

Inflow Area = 51,214 sf, 80.59% Impervious, Inflow Depth = 2.39" for 2-yr event
 Inflow = 3.29 cfs @ 12.07 hrs, Volume= 10,194 cf
 Primary = 3.29 cfs @ 12.07 hrs, Volume= 10,194 cf, Atten= 0%, Lag= 0.0 min
 Routed to nonexistent node 2R

Primary outflow = Inflow, Time Span= 0.00-48.00 hrs, dt= 0.01 hrs

Summary for Link DP2: Drainage System #2

Inflow Area = 137,689 sf, 57.62% Impervious, Inflow Depth = 1.42" for 2-yr event
 Inflow = 3.50 cfs @ 12.08 hrs, Volume= 16,289 cf
 Primary = 3.50 cfs @ 12.08 hrs, Volume= 16,289 cf, Atten= 0%, Lag= 0.0 min
 Routed to nonexistent node 2R

Primary outflow = Inflow, Time Span= 0.00-48.00 hrs, dt= 0.01 hrs

Existing Conditions 2015-09-24

Prepared by Haley Ward

HydroCAD® 10.20-3g s/n 00801 © 2023 HydroCAD Software Solutions LLC

Type III 24-hr 10-yr Rainfall=5.62"

Printed 11/17/2023

Page 17

Time span=0.00-48.00 hrs, dt=0.01 hrs, 4801 points
 Runoff by SCS TR-20 method, UH=SCS, Weighted-CN
 Reach routing by Stor-Ind+Trans method - Pond routing by Stor-Ind method

Subcatchment E1a: PS1a	Runoff Area=20,120 sf 65.08% Impervious Runoff Depth=3.15" Tc=5.0 min CN=77 Runoff=1.77 cfs 5,281 cf
Subcatchment E1b: PS1b	Runoff Area=27,062 sf 89.28% Impervious Runoff Depth=4.70" Tc=5.0 min CN=92 Runoff=3.34 cfs 10,591 cf
Subcatchment E1c: PS1c	Runoff Area=4,032 sf 99.58% Impervious Runoff Depth=5.38" Tc=5.0 min CN=98 Runoff=0.53 cfs 1,808 cf
Subcatchment E2a: PS2a	Runoff Area=8,301 sf 41.78% Impervious Runoff Depth=2.00" Tc=5.0 min CN=64 Runoff=0.45 cfs 1,381 cf
Subcatchment E2b: PS2b	Runoff Area=16,660 sf 87.98% Impervious Runoff Depth=4.59" Tc=5.0 min CN=91 Runoff=2.02 cfs 6,367 cf
Subcatchment E2c: PS2c	Runoff Area=16,042 sf 92.13% Impervious Runoff Depth=4.81" Tc=5.0 min CN=93 Runoff=2.01 cfs 6,427 cf
Subcatchment E2d: PS2d	Runoff Area=7,341 sf 95.70% Impervious Runoff Depth=5.03" Tc=5.0 min CN=95 Runoff=0.94 cfs 3,080 cf
Subcatchment E3: PS3	Runoff Area=9,577 sf 29.98% Impervious Runoff Depth=1.45" Tc=5.0 min CN=57 Runoff=0.35 cfs 1,157 cf
Subcatchment O1: Off-Site	Runoff Area=79,768 sf 45.80% Impervious Runoff Depth=2.08" Flow Length=584' Tc=27.6 min CN=65 Runoff=2.53 cfs 13,820 cf
Pond 1a: CB1a	Peak Elev=21.43' Inflow=1.77 cfs 5,281 cf 12.0" Round Culvert n=0.025 L=203.0' S=0.0126 '/' Outflow=1.77 cfs 5,281 cf
Pond 1b: CB1b	Peak Elev=20.98' Inflow=5.10 cfs 15,872 cf 15.0" Round Culvert n=0.025 L=200.0' S=0.0150 '/' Outflow=5.10 cfs 15,872 cf
Pond 2a: CB2a	Peak Elev=21.35' Inflow=2.69 cfs 15,201 cf 12.0" Round Culvert n=0.025 L=54.0' S=0.0000 '/' Outflow=2.69 cfs 15,201 cf
Pond 2b: CB2b	Peak Elev=21.17' Inflow=3.32 cfs 21,567 cf 15.0" Round Culvert n=0.025 L=200.0' S=0.0028 '/' Outflow=3.32 cfs 21,567 cf
Pond 2c: CB2c	Peak Elev=23.28' Inflow=5.31 cfs 27,995 cf 15.0" Round Culvert n=0.025 L=375.0' S=0.0150 '/' Outflow=5.31 cfs 27,995 cf
Pond 2d: CB2d	Peak Elev=22.12' Inflow=6.25 cfs 31,074 cf 15.0" Round Culvert n=0.025 L=100.0' S=0.0050 '/' Outflow=6.25 cfs 31,074 cf
Link DP1: Drainage System #1	Inflow=5.63 cfs 17,680 cf Primary=5.63 cfs 17,680 cf

Existing Conditions 2015-09-24

Prepared by Haley Ward

HydroCAD® 10.20-3g s/n 00801 © 2023 HydroCAD Software Solutions LLC

Type III 24-hr 10-yr Rainfall=5.62"

Printed 11/17/2023

Page 18

Link DP2: Drainage System #2

Inflow=6.59 cfs 32,232 cf
Primary=6.59 cfs 32,232 cf

Total Runoff Area = 188,903 sf Runoff Volume = 49,912 cf Average Runoff Depth = 3.17"
36.15% Pervious = 68,294 sf 63.85% Impervious = 120,609 sf

Existing Conditions 2015-09-24

Prepared by Haley Ward

HydroCAD® 10.20-3g s/n 00801 © 2023 HydroCAD Software Solutions LLC

Type III 24-hr 10-yr Rainfall=5.62"

Printed 11/17/2023

Page 19

Summary for Subcatchment E1a: PS1a

Runoff = 1.77 cfs @ 12.07 hrs, Volume= 5,281 cf, Depth= 3.15"
Routed to Pond 1a : CB1a

Runoff by SCS TR-20 method, UH=SCS, Weighted-CN, Time Span= 0.00-48.00 hrs, dt= 0.01 hrs
Type III 24-hr 10-yr Rainfall=5.62"

Area (sf)	CN	Description
4,566	98	Roofs, HSG A
7,025	39	>75% Grass cover, Good, HSG A
8,529	98	Paved parking, HSG A
20,120	77	Weighted Average
7,025		34.92% Pervious Area
13,095		65.08% Impervious Area

Tc (min)	Length (feet)	Slope (ft/ft)	Velocity (ft/sec)	Capacity (cfs)	Description
5.0					Direct Entry,

Summary for Subcatchment E1b: PS1b

Runoff = 3.34 cfs @ 12.07 hrs, Volume= 10,591 cf, Depth= 4.70"
Routed to Pond 1b : CB1b

Runoff by SCS TR-20 method, UH=SCS, Weighted-CN, Time Span= 0.00-48.00 hrs, dt= 0.01 hrs
Type III 24-hr 10-yr Rainfall=5.62"

Area (sf)	CN	Description
2,901	39	>75% Grass cover, Good, HSG A
3,319	98	Roofs, HSG A
20,842	98	Paved parking, HSG A
27,062	92	Weighted Average
2,901		10.72% Pervious Area
24,161		89.28% Impervious Area

Tc (min)	Length (feet)	Slope (ft/ft)	Velocity (ft/sec)	Capacity (cfs)	Description
5.0					Direct Entry,

Summary for Subcatchment E1c: PS1c

Runoff = 0.53 cfs @ 12.07 hrs, Volume= 1,808 cf, Depth= 5.38"
Routed to Link DP1 : Drainage System #1

Runoff by SCS TR-20 method, UH=SCS, Weighted-CN, Time Span= 0.00-48.00 hrs, dt= 0.01 hrs
Type III 24-hr 10-yr Rainfall=5.62"

Existing Conditions 2015-09-24

Type III 24-hr 10-yr Rainfall=5.62"

Prepared by Haley Ward

Printed 11/17/2023

HydroCAD® 10.20-3g s/n 00801 © 2023 HydroCAD Software Solutions LLC

Page 20

Area (sf)	CN	Description
17	39	>75% Grass cover, Good, HSG A
4,015	98	Paved parking, HSG A
4,032	98	Weighted Average
17		0.42% Pervious Area
4,015		99.58% Impervious Area

Tc (min)	Length (feet)	Slope (ft/ft)	Velocity (ft/sec)	Capacity (cfs)	Description
5.0					Direct Entry,

Summary for Subcatchment E2a: PS2a

Runoff = 0.45 cfs @ 12.08 hrs, Volume= 1,381 cf, Depth= 2.00"
 Routed to Pond 2a : CB2a

Runoff by SCS TR-20 method, UH=SCS, Weighted-CN, Time Span= 0.00-48.00 hrs, dt= 0.01 hrs
 Type III 24-hr 10-yr Rainfall=5.62"

Area (sf)	CN	Description
56	98	Roofs, HSG A
4,833	39	>75% Grass cover, Good, HSG A
3,412	98	Paved parking, HSG A
8,301	64	Weighted Average
4,833		58.22% Pervious Area
3,468		41.78% Impervious Area

Tc (min)	Length (feet)	Slope (ft/ft)	Velocity (ft/sec)	Capacity (cfs)	Description
5.0					Direct Entry,

Summary for Subcatchment E2b: PS2b

Runoff = 2.02 cfs @ 12.07 hrs, Volume= 6,367 cf, Depth= 4.59"
 Routed to Pond 2b : CB2b

Runoff by SCS TR-20 method, UH=SCS, Weighted-CN, Time Span= 0.00-48.00 hrs, dt= 0.01 hrs
 Type III 24-hr 10-yr Rainfall=5.62"

Area (sf)	CN	Description
3,630	98	Roofs, HSG A
2,003	39	>75% Grass cover, Good, HSG A
11,027	98	Paved parking, HSG A
16,660	91	Weighted Average
2,003		12.02% Pervious Area
14,657		87.98% Impervious Area

Existing Conditions 2015-09-24

Prepared by Haley Ward

HydroCAD® 10.20-3g s/n 00801 © 2023 HydroCAD Software Solutions LLC

Type III 24-hr 10-yr Rainfall=5.62"

Printed 11/17/2023

Page 21

Tc (min)	Length (feet)	Slope (ft/ft)	Velocity (ft/sec)	Capacity (cfs)	Description
5.0					Direct Entry,

Summary for Subcatchment E2c: PS2c

Runoff = 2.01 cfs @ 12.07 hrs, Volume= 6,427 cf, Depth= 4.81"
Routed to Pond 2c : CB2c

Runoff by SCS TR-20 method, UH=SCS, Weighted-CN, Time Span= 0.00-48.00 hrs, dt= 0.01 hrs
Type III 24-hr 10-yr Rainfall=5.62"

Area (sf)	CN	Description
4,423	98	Roofs, HSG A
1,262	39	>75% Grass cover, Good, HSG A
10,357	98	Paved parking, HSG A
16,042	93	Weighted Average
1,262		7.87% Pervious Area
14,780		92.13% Impervious Area

Tc (min)	Length (feet)	Slope (ft/ft)	Velocity (ft/sec)	Capacity (cfs)	Description
5.0					Direct Entry,

Summary for Subcatchment E2d: PS2d

Runoff = 0.94 cfs @ 12.07 hrs, Volume= 3,080 cf, Depth= 5.03"
Routed to Pond 2d : CB2d

Runoff by SCS TR-20 method, UH=SCS, Weighted-CN, Time Span= 0.00-48.00 hrs, dt= 0.01 hrs
Type III 24-hr 10-yr Rainfall=5.62"

Area (sf)	CN	Description
316	39	>75% Grass cover, Good, HSG A
7,025	98	Paved parking, HSG A
7,341	95	Weighted Average
316		4.30% Pervious Area
7,025		95.70% Impervious Area

Tc (min)	Length (feet)	Slope (ft/ft)	Velocity (ft/sec)	Capacity (cfs)	Description
5.0					Direct Entry,

Summary for Subcatchment E3: PS3

Runoff = 0.35 cfs @ 12.09 hrs, Volume= 1,157 cf, Depth= 1.45"
Routed to Link DP2 : Drainage System #2

Runoff by SCS TR-20 method, UH=SCS, Weighted-CN, Time Span= 0.00-48.00 hrs, dt= 0.01 hrs
Type III 24-hr 10-yr Rainfall=5.62"

Existing Conditions 2015-09-24

Prepared by Haley Ward

HydroCAD® 10.20-3g s/n 00801 © 2023 HydroCAD Software Solutions LLC

Type III 24-hr 10-yr Rainfall=5.62"

Printed 11/17/2023

Page 22

Area (sf)	CN	Description
6,706	39	>75% Grass cover, Good, HSG A
2,871	98	Paved parking, HSG A
9,577	57	Weighted Average
6,706		70.02% Pervious Area
2,871		29.98% Impervious Area

Tc (min)	Length (feet)	Slope (ft/ft)	Velocity (ft/sec)	Capacity (cfs)	Description
5.0					Direct Entry,

Summary for Subcatchment O1: Off-Site

[47] Hint: Peak is 116% of capacity of segment #3

Runoff = 2.53 cfs @ 12.42 hrs, Volume= 13,820 cf, Depth= 2.08"
 Routed to Pond 2a : CB2a

Runoff by SCS TR-20 method, UH=SCS, Weighted-CN, Time Span= 0.00-48.00 hrs, dt= 0.01 hrs
 Type III 24-hr 10-yr Rainfall=5.62"

Area (sf)	CN	Description
2,453	98	Unconnected roofs, HSG A
34,084	98	Paved parking, HSG A
22,052	36	Woods, Fair, HSG A
21,179	39	>75% Grass cover, Good, HSG A
79,768	65	Weighted Average
43,231		54.20% Pervious Area
36,537		45.80% Impervious Area
2,453		6.71% Unconnected

Tc (min)	Length (feet)	Slope (ft/ft)	Velocity (ft/sec)	Capacity (cfs)	Description
19.6	100	0.0250	0.08		Sheet Flow, Woods: Light underbrush n= 0.400 P2= 3.20"
7.3	374	0.0150	0.86		Shallow Concentrated Flow, Short Grass Pasture Kv= 7.0 fps
0.7	110	0.0050	2.78	2.18	Pipe Channel, RCP_Round 12" 12.0" Round Area= 0.8 sf Perim= 3.1' r= 0.25' n= 0.015 Concrete sewer w/manholes & inlets
27.6	584	Total			

Summary for Pond 1a: CB1a

[57] Hint: Peaked at 21.43' (Flood elevation advised)

Existing Conditions 2015-09-24

Type III 24-hr 10-yr Rainfall=5.62"

Prepared by Haley Ward

Printed 11/17/2023

HydroCAD® 10.20-3g s/n 00801 © 2023 HydroCAD Software Solutions LLC

Page 23

Inflow Area = 20,120 sf, 65.08% Impervious, Inflow Depth = 3.15" for 10-yr event
 Inflow = 1.77 cfs @ 12.07 hrs, Volume= 5,281 cf
 Outflow = 1.77 cfs @ 12.07 hrs, Volume= 5,281 cf, Atten= 0%, Lag= 0.0 min
 Primary = 1.77 cfs @ 12.07 hrs, Volume= 5,281 cf
 Routed to Pond 1b : CB1b

Routing by Stor-Ind method, Time Span= 0.00-48.00 hrs, dt= 0.01 hrs
 Peak Elev= 21.43' @ 12.07 hrs

Device	Routing	Invert	Outlet Devices
#1	Primary	20.49'	12.0" Round CMP_Round 12" L= 203.0' CMP, square edge headwall, Ke= 0.500 Inlet / Outlet Invert= 20.49' / 17.94' S= 0.0126 1' Cc= 0.900 n= 0.025 Corrugated metal, Flow Area= 0.79 sf

Primary OutFlow Max=1.76 cfs @ 12.07 hrs HW=21.43' (Free Discharge)
 ↑1=CMP_Round 12" (Barrel Controls 1.76 cfs @ 2.98 fps)

Summary for Pond 1b: CB1b

[57] Hint: Peaked at 20.98' (Flood elevation advised)

[79] Warning: Submerged Pond 1a Primary device # 1 INLET by 0.48'

Inflow Area = 47,182 sf, 78.96% Impervious, Inflow Depth = 4.04" for 10-yr event
 Inflow = 5.10 cfs @ 12.07 hrs, Volume= 15,872 cf
 Outflow = 5.10 cfs @ 12.07 hrs, Volume= 15,872 cf, Atten= 0%, Lag= 0.0 min
 Primary = 5.10 cfs @ 12.07 hrs, Volume= 15,872 cf
 Routed to Link DP1 : Drainage System #1

Routing by Stor-Ind method, Time Span= 0.00-48.00 hrs, dt= 0.01 hrs
 Peak Elev= 20.98' @ 12.07 hrs

Device	Routing	Invert	Outlet Devices
#1	Primary	17.69'	15.0" Round CMP_Round 15" L= 200.0' CMP, square edge headwall, Ke= 0.500 Inlet / Outlet Invert= 17.69' / 14.69' S= 0.0150 1' Cc= 0.900 n= 0.025 Corrugated metal, Flow Area= 1.23 sf

Primary OutFlow Max=5.10 cfs @ 12.07 hrs HW=20.96' (Free Discharge)
 ↑1=CMP_Round 15" (Barrel Controls 5.10 cfs @ 4.15 fps)

Summary for Pond 2a: CB2a

[57] Hint: Peaked at 21.35' (Flood elevation advised)

Inflow Area = 88,069 sf, 45.42% Impervious, Inflow Depth = 2.07" for 10-yr event
 Inflow = 2.69 cfs @ 12.39 hrs, Volume= 15,201 cf
 Outflow = 2.69 cfs @ 12.39 hrs, Volume= 15,201 cf, Atten= 0%, Lag= 0.0 min
 Primary = 2.69 cfs @ 12.39 hrs, Volume= 15,201 cf
 Routed to Pond 2b : CB2b

Routing by Stor-Ind method, Time Span= 0.00-48.00 hrs, dt= 0.01 hrs

Existing Conditions 2015-09-24

Prepared by Haley Ward

HydroCAD® 10.20-3g s/n 00801 © 2023 HydroCAD Software Solutions LLC

Type III 24-hr 10-yr Rainfall=5.62"

Printed 11/17/2023

Page 24

Peak Elev= 21.35' @ 12.39 hrs

Device	Routing	Invert	Outlet Devices
#1	Primary	18.94'	12.0" Round CMP_Round 12" L= 54.0' CMP, square edge headwall, Ke= 0.500 Inlet / Outlet Invert= 18.94' / 18.94' S= 0.0000 '/ Cc= 0.900 n= 0.025 Corrugated metal, Flow Area= 0.79 sf

Primary OutFlow Max=2.69 cfs @ 12.39 hrs HW=21.35' (Free Discharge)

↑1=CMP_Round 12" (Barrel Controls 2.69 cfs @ 3.42 fps)

Summary for Pond 2b: CB2b

[57] Hint: Peaked at 21.17' (Flood elevation advised)

[81] Warning: Exceeded Pond 2a by 1.00' @ 12.07 hrs

Inflow Area = 104,729 sf, 52.19% Impervious, Inflow Depth = 2.47" for 10-yr event
Inflow = 3.32 cfs @ 12.09 hrs, Volume= 21,567 cf
Outflow = 3.32 cfs @ 12.09 hrs, Volume= 21,567 cf, Atten= 0%, Lag= 0.0 min
Primary = 3.32 cfs @ 12.09 hrs, Volume= 21,567 cf
Routed to Pond 2c : CB2c

Routing by Stor-Ind method, Time Span= 0.00-48.00 hrs, dt= 0.01 hrs

Peak Elev= 21.17' @ 12.09 hrs

Device	Routing	Invert	Outlet Devices
#1	Primary	18.34'	15.0" Round CMP_Round 15" L= 200.0' CMP, square edge headwall, Ke= 0.500 Inlet / Outlet Invert= 18.34' / 17.78' S= 0.0028 '/ Cc= 0.900 n= 0.025 Corrugated metal, Flow Area= 1.23 sf

Primary OutFlow Max=3.32 cfs @ 12.09 hrs HW=21.16' (Free Discharge)

↑1=CMP_Round 15" (Barrel Controls 3.32 cfs @ 2.71 fps)

Summary for Pond 2c: CB2c

[57] Hint: Peaked at 23.28' (Flood elevation advised)

[81] Warning: Exceeded Pond 2b by 2.11' @ 12.08 hrs

Inflow Area = 120,771 sf, 57.50% Impervious, Inflow Depth = 2.78" for 10-yr event
Inflow = 5.31 cfs @ 12.08 hrs, Volume= 27,995 cf
Outflow = 5.31 cfs @ 12.08 hrs, Volume= 27,995 cf, Atten= 0%, Lag= 0.0 min
Primary = 5.31 cfs @ 12.08 hrs, Volume= 27,995 cf
Routed to Pond 2d : CB2d

Routing by Stor-Ind method, Time Span= 0.00-48.00 hrs, dt= 0.01 hrs

Peak Elev= 23.28' @ 12.08 hrs

Device	Routing	Invert	Outlet Devices
#1	Primary	17.80'	15.0" Round CMP_Round 15" L= 375.0' CMP, square edge headwall, Ke= 0.500

Existing Conditions 2015-09-24

Prepared by Haley Ward

HydroCAD® 10.20-3g s/n 00801 © 2023 HydroCAD Software Solutions LLC

Type III 24-hr 10-yr Rainfall=5.62"

Printed 11/17/2023

Page 25

Inlet / Outlet Invert= 17.80' / 12.18' S= 0.0150 '/ n= 0.025 Corrugated metal, Flow Area= 1.23 sf

Primary OutFlow Max=5.31 cfs @ 12.08 hrs HW=23.26' (Free Discharge)

↑1=CMP_Round 15" (Barrel Controls 5.31 cfs @ 4.32 fps)

Summary for Pond 2d: CB2d

[57] Hint: Peaked at 22.12' (Flood elevation advised)

[81] Warning: Exceeded Pond 2c by 1.36' @ 12.02 hrs

Inflow Area = 128,112 sf, 59.69% Impervious, Inflow Depth = 2.91" for 10-yr event
Inflow = 6.25 cfs @ 12.08 hrs, Volume= 31,074 cf
Outflow = 6.25 cfs @ 12.08 hrs, Volume= 31,074 cf, Atten= 0%, Lag= 0.0 min
Primary = 6.25 cfs @ 12.08 hrs, Volume= 31,074 cf
Routed to Link DP2 : Drainage System #2

Routing by Stor-Ind method, Time Span= 0.00-48.00 hrs, dt= 0.01 hrs
Peak Elev= 22.12' @ 12.08 hrs

Device	Routing	Invert	Outlet Devices
#1	Primary	17.29'	15.0" Round CMP_Round 15" L= 100.0' CMP, square edge headwall, Ke= 0.500 Inlet / Outlet Invert= 17.29' / 16.79' S= 0.0050 '/ n= 0.025 Corrugated metal, Flow Area= 1.23 sf

Primary OutFlow Max=6.24 cfs @ 12.08 hrs HW=22.10' (Free Discharge)

↑1=CMP_Round 15" (Barrel Controls 6.24 cfs @ 5.08 fps)

Summary for Link DP1: Drainage System #1

Inflow Area = 51,214 sf, 80.59% Impervious, Inflow Depth = 4.14" for 10-yr event
Inflow = 5.63 cfs @ 12.07 hrs, Volume= 17,680 cf
Primary = 5.63 cfs @ 12.07 hrs, Volume= 17,680 cf, Atten= 0%, Lag= 0.0 min
Routed to nonexistent node 2R

Primary outflow = Inflow, Time Span= 0.00-48.00 hrs, dt= 0.01 hrs

Summary for Link DP2: Drainage System #2

Inflow Area = 137,689 sf, 57.62% Impervious, Inflow Depth = 2.81" for 10-yr event
Inflow = 6.59 cfs @ 12.08 hrs, Volume= 32,232 cf
Primary = 6.59 cfs @ 12.08 hrs, Volume= 32,232 cf, Atten= 0%, Lag= 0.0 min
Routed to nonexistent node 2R

Primary outflow = Inflow, Time Span= 0.00-48.00 hrs, dt= 0.01 hrs

Existing Conditions 2015-09-24

Type III 24-hr 25-yr Rainfall=7.13"

Prepared by Haley Ward

Printed 11/17/2023

HydroCAD® 10.20-3g s/n 00801 © 2023 HydroCAD Software Solutions LLC

Page 26

Time span=0.00-48.00 hrs, dt=0.01 hrs, 4801 points
 Runoff by SCS TR-20 method, UH=SCS, Weighted-CN
 Reach routing by Stor-Ind+Trans method - Pond routing by Stor-Ind method

Subcatchment E1a: PS1a	Runoff Area=20,120 sf 65.08% Impervious Runoff Depth=4.48" Tc=5.0 min CN=77 Runoff=2.51 cfs 7,516 cf
Subcatchment E1b: PS1b	Runoff Area=27,062 sf 89.28% Impervious Runoff Depth=6.18" Tc=5.0 min CN=92 Runoff=4.32 cfs 13,944 cf
Subcatchment E1c: PS1c	Runoff Area=4,032 sf 99.58% Impervious Runoff Depth=6.89" Tc=5.0 min CN=98 Runoff=0.67 cfs 2,315 cf
Subcatchment E2a: PS2a	Runoff Area=8,301 sf 41.78% Impervious Runoff Depth=3.10" Tc=5.0 min CN=64 Runoff=0.71 cfs 2,145 cf
Subcatchment E2b: PS2b	Runoff Area=16,660 sf 87.98% Impervious Runoff Depth=6.07" Tc=5.0 min CN=91 Runoff=2.63 cfs 8,423 cf
Subcatchment E2c: PS2c	Runoff Area=16,042 sf 92.13% Impervious Runoff Depth=6.30" Tc=5.0 min CN=93 Runoff=2.59 cfs 8,422 cf
Subcatchment E2d: PS2d	Runoff Area=7,341 sf 95.70% Impervious Runoff Depth=6.54" Tc=5.0 min CN=95 Runoff=1.20 cfs 3,998 cf
Subcatchment E3: PS3	Runoff Area=9,577 sf 29.98% Impervious Runoff Depth=2.40" Tc=5.0 min CN=57 Runoff=0.61 cfs 1,916 cf
Subcatchment O1: Off-Site	Runoff Area=79,768 sf 45.80% Impervious Runoff Depth=3.20" Flow Length=584' Tc=27.6 min CN=65 Runoff=3.99 cfs 21,294 cf
Pond 1a: CB1a	Peak Elev=22.91' Inflow=2.51 cfs 7,516 cf 12.0" Round Culvert n=0.025 L=203.0' S=0.0126 '/' Outflow=2.51 cfs 7,516 cf
Pond 1b: CB1b	Peak Elev=24.96' Inflow=6.83 cfs 21,460 cf 15.0" Round Culvert n=0.025 L=200.0' S=0.0150 '/' Outflow=6.83 cfs 21,460 cf
Pond 2a: CB2a	Peak Elev=23.45' Inflow=4.23 cfs 23,439 cf 12.0" Round Culvert n=0.025 L=54.0' S=0.0000 '/' Outflow=4.23 cfs 23,439 cf
Pond 2b: CB2b	Peak Elev=23.96' Inflow=5.05 cfs 31,862 cf 15.0" Round Culvert n=0.025 L=200.0' S=0.0028 '/' Outflow=5.05 cfs 31,862 cf
Pond 2c: CB2c	Peak Elev=32.62' Inflow=7.42 cfs 40,284 cf 15.0" Round Culvert n=0.025 L=375.0' S=0.0150 '/' Outflow=7.42 cfs 40,284 cf
Pond 2d: CB2d	Peak Elev=25.78' Inflow=8.61 cfs 44,282 cf 15.0" Round Culvert n=0.025 L=100.0' S=0.0050 '/' Outflow=8.61 cfs 44,282 cf
Link DP1: Drainage System #1	Inflow=7.50 cfs 23,776 cf Primary=7.50 cfs 23,776 cf

Existing Conditions 2015-09-24

Prepared by Haley Ward

HydroCAD® 10.20-3g s/n 00801 © 2023 HydroCAD Software Solutions LLC

Type III 24-hr 25-yr Rainfall=7.13"

Printed 11/17/2023

Page 27

Link DP2: Drainage System #2

Inflow=9.22 cfs 46,197 cf
Primary=9.22 cfs 46,197 cf

Total Runoff Area = 188,903 sf Runoff Volume = 69,973 cf Average Runoff Depth = 4.44"
36.15% Pervious = 68,294 sf 63.85% Impervious = 120,609 sf

Existing Conditions 2015-09-24

Prepared by Haley Ward

HydroCAD® 10.20-3g s/n 00801 © 2023 HydroCAD Software Solutions LLC

Type III 24-hr 25-yr Rainfall=7.13"

Printed 11/17/2023

Page 28

Summary for Subcatchment E1a: PS1a

Runoff = 2.51 cfs @ 12.07 hrs, Volume= 7,516 cf, Depth= 4.48"
Routed to Pond 1a : CB1a

Runoff by SCS TR-20 method, UH=SCS, Weighted-CN, Time Span= 0.00-48.00 hrs, dt= 0.01 hrs
Type III 24-hr 25-yr Rainfall=7.13"

Area (sf)	CN	Description
4,566	98	Roofs, HSG A
7,025	39	>75% Grass cover, Good, HSG A
8,529	98	Paved parking, HSG A
20,120	77	Weighted Average
7,025		34.92% Pervious Area
13,095		65.08% Impervious Area

Tc (min)	Length (feet)	Slope (ft/ft)	Velocity (ft/sec)	Capacity (cfs)	Description
5.0					Direct Entry,

Summary for Subcatchment E1b: PS1b

Runoff = 4.32 cfs @ 12.07 hrs, Volume= 13,944 cf, Depth= 6.18"
Routed to Pond 1b : CB1b

Runoff by SCS TR-20 method, UH=SCS, Weighted-CN, Time Span= 0.00-48.00 hrs, dt= 0.01 hrs
Type III 24-hr 25-yr Rainfall=7.13"

Area (sf)	CN	Description
2,901	39	>75% Grass cover, Good, HSG A
3,319	98	Roofs, HSG A
20,842	98	Paved parking, HSG A
27,062	92	Weighted Average
2,901		10.72% Pervious Area
24,161		89.28% Impervious Area

Tc (min)	Length (feet)	Slope (ft/ft)	Velocity (ft/sec)	Capacity (cfs)	Description
5.0					Direct Entry,

Summary for Subcatchment E1c: PS1c

Runoff = 0.67 cfs @ 12.07 hrs, Volume= 2,315 cf, Depth= 6.89"
Routed to Link DP1 : Drainage System #1

Runoff by SCS TR-20 method, UH=SCS, Weighted-CN, Time Span= 0.00-48.00 hrs, dt= 0.01 hrs
Type III 24-hr 25-yr Rainfall=7.13"

Existing Conditions 2015-09-24

Prepared by Haley Ward

HydroCAD® 10.20-3g s/n 00801 © 2023 HydroCAD Software Solutions LLC

Type III 24-hr 25-yr Rainfall=7.13"

Printed 11/17/2023

Page 29

Area (sf)	CN	Description
17	39	>75% Grass cover, Good, HSG A
4,015	98	Paved parking, HSG A
4,032	98	Weighted Average
17		0.42% Pervious Area
4,015		99.58% Impervious Area

Tc (min)	Length (feet)	Slope (ft/ft)	Velocity (ft/sec)	Capacity (cfs)	Description
5.0					Direct Entry,

Summary for Subcatchment E2a: PS2a

Runoff = 0.71 cfs @ 12.08 hrs, Volume= 2,145 cf, Depth= 3.10"
 Routed to Pond 2a : CB2a

Runoff by SCS TR-20 method, UH=SCS, Weighted-CN, Time Span= 0.00-48.00 hrs, dt= 0.01 hrs
 Type III 24-hr 25-yr Rainfall=7.13"

Area (sf)	CN	Description
56	98	Roofs, HSG A
4,833	39	>75% Grass cover, Good, HSG A
3,412	98	Paved parking, HSG A
8,301	64	Weighted Average
4,833		58.22% Pervious Area
3,468		41.78% Impervious Area

Tc (min)	Length (feet)	Slope (ft/ft)	Velocity (ft/sec)	Capacity (cfs)	Description
5.0					Direct Entry,

Summary for Subcatchment E2b: PS2b

Runoff = 2.63 cfs @ 12.07 hrs, Volume= 8,423 cf, Depth= 6.07"
 Routed to Pond 2b : CB2b

Runoff by SCS TR-20 method, UH=SCS, Weighted-CN, Time Span= 0.00-48.00 hrs, dt= 0.01 hrs
 Type III 24-hr 25-yr Rainfall=7.13"

Area (sf)	CN	Description
3,630	98	Roofs, HSG A
2,003	39	>75% Grass cover, Good, HSG A
11,027	98	Paved parking, HSG A
16,660	91	Weighted Average
2,003		12.02% Pervious Area
14,657		87.98% Impervious Area

Existing Conditions 2015-09-24

Prepared by Haley Ward

HydroCAD® 10.20-3g s/n 00801 © 2023 HydroCAD Software Solutions LLC

Type III 24-hr 25-yr Rainfall=7.13"

Printed 11/17/2023

Page 30

Tc (min)	Length (feet)	Slope (ft/ft)	Velocity (ft/sec)	Capacity (cfs)	Description
5.0					Direct Entry,

Summary for Subcatchment E2c: PS2c

Runoff = 2.59 cfs @ 12.07 hrs, Volume= 8,422 cf, Depth= 6.30"
Routed to Pond 2c : CB2c

Runoff by SCS TR-20 method, UH=SCS, Weighted-CN, Time Span= 0.00-48.00 hrs, dt= 0.01 hrs
Type III 24-hr 25-yr Rainfall=7.13"

Area (sf)	CN	Description
4,423	98	Roofs, HSG A
1,262	39	>75% Grass cover, Good, HSG A
10,357	98	Paved parking, HSG A
16,042	93	Weighted Average
1,262		7.87% Pervious Area
14,780		92.13% Impervious Area

Tc (min)	Length (feet)	Slope (ft/ft)	Velocity (ft/sec)	Capacity (cfs)	Description
5.0					Direct Entry,

Summary for Subcatchment E2d: PS2d

Runoff = 1.20 cfs @ 12.07 hrs, Volume= 3,998 cf, Depth= 6.54"
Routed to Pond 2d : CB2d

Runoff by SCS TR-20 method, UH=SCS, Weighted-CN, Time Span= 0.00-48.00 hrs, dt= 0.01 hrs
Type III 24-hr 25-yr Rainfall=7.13"

Area (sf)	CN	Description
316	39	>75% Grass cover, Good, HSG A
7,025	98	Paved parking, HSG A
7,341	95	Weighted Average
316		4.30% Pervious Area
7,025		95.70% Impervious Area

Tc (min)	Length (feet)	Slope (ft/ft)	Velocity (ft/sec)	Capacity (cfs)	Description
5.0					Direct Entry,

Summary for Subcatchment E3: PS3

Runoff = 0.61 cfs @ 12.08 hrs, Volume= 1,916 cf, Depth= 2.40"
Routed to Link DP2 : Drainage System #2

Runoff by SCS TR-20 method, UH=SCS, Weighted-CN, Time Span= 0.00-48.00 hrs, dt= 0.01 hrs
Type III 24-hr 25-yr Rainfall=7.13"

Existing Conditions 2015-09-24

Prepared by Haley Ward

HydroCAD® 10.20-3g s/n 00801 © 2023 HydroCAD Software Solutions LLC

Type III 24-hr 25-yr Rainfall=7.13"

Printed 11/17/2023

Page 31

Area (sf)	CN	Description
6,706	39	>75% Grass cover, Good, HSG A
2,871	98	Paved parking, HSG A
9,577	57	Weighted Average
6,706		70.02% Pervious Area
2,871		29.98% Impervious Area

Tc (min)	Length (feet)	Slope (ft/ft)	Velocity (ft/sec)	Capacity (cfs)	Description
5.0					Direct Entry,

Summary for Subcatchment O1: Off-Site

[47] Hint: Peak is 183% of capacity of segment #3

Runoff = 3.99 cfs @ 12.39 hrs, Volume= 21,294 cf, Depth= 3.20"
 Routed to Pond 2a : CB2a

Runoff by SCS TR-20 method, UH=SCS, Weighted-CN, Time Span= 0.00-48.00 hrs, dt= 0.01 hrs
 Type III 24-hr 25-yr Rainfall=7.13"

Area (sf)	CN	Description
2,453	98	Unconnected roofs, HSG A
34,084	98	Paved parking, HSG A
22,052	36	Woods, Fair, HSG A
21,179	39	>75% Grass cover, Good, HSG A
79,768	65	Weighted Average
43,231		54.20% Pervious Area
36,537		45.80% Impervious Area
2,453		6.71% Unconnected

Tc (min)	Length (feet)	Slope (ft/ft)	Velocity (ft/sec)	Capacity (cfs)	Description
19.6	100	0.0250	0.08		Sheet Flow, Woods: Light underbrush n= 0.400 P2= 3.20"
7.3	374	0.0150	0.86		Shallow Concentrated Flow, Short Grass Pasture Kv= 7.0 fps
0.7	110	0.0050	2.78	2.18	Pipe Channel, RCP_Round 12" 12.0" Round Area= 0.8 sf Perim= 3.1' r= 0.25' n= 0.015 Concrete sewer w/manholes & inlets
27.6	584	Total			

Summary for Pond 1a: CB1a

[57] Hint: Peaked at 22.91' (Flood elevation advised)

Existing Conditions 2015-09-24

Prepared by Haley Ward

HydroCAD® 10.20-3g s/n 00801 © 2023 HydroCAD Software Solutions LLC

Type III 24-hr 25-yr Rainfall=7.13"

Printed 11/17/2023

Page 32

Inflow Area = 20,120 sf, 65.08% Impervious, Inflow Depth = 4.48" for 25-yr event
Inflow = 2.51 cfs @ 12.07 hrs, Volume= 7,516 cf
Outflow = 2.51 cfs @ 12.07 hrs, Volume= 7,516 cf, Atten= 0%, Lag= 0.0 min
Primary = 2.51 cfs @ 12.07 hrs, Volume= 7,516 cf
Routed to Pond 1b : CB1b

Routing by Stor-Ind method, Time Span= 0.00-48.00 hrs, dt= 0.01 hrs
Peak Elev= 22.91' @ 12.07 hrs

Device	Routing	Invert	Outlet Devices
#1	Primary	20.49'	12.0" Round CMP_Round 12" L= 203.0' CMP, square edge headwall, Ke= 0.500 Inlet / Outlet Invert= 20.49' / 17.94' S= 0.0126 1' Cc= 0.900 n= 0.025 Corrugated metal, Flow Area= 0.79 sf

Primary OutFlow Max=2.50 cfs @ 12.07 hrs HW=22.89' (Free Discharge)
↑1=CMP_Round 12" (Barrel Controls 2.50 cfs @ 3.19 fps)

Summary for Pond 1b: CB1b

[57] Hint: Peaked at 24.96' (Flood elevation advised)
[81] Warning: Exceeded Pond 1a by 2.06' @ 12.07 hrs

Inflow Area = 47,182 sf, 78.96% Impervious, Inflow Depth = 5.46" for 25-yr event
Inflow = 6.83 cfs @ 12.07 hrs, Volume= 21,460 cf
Outflow = 6.83 cfs @ 12.07 hrs, Volume= 21,460 cf, Atten= 0%, Lag= 0.0 min
Primary = 6.83 cfs @ 12.07 hrs, Volume= 21,460 cf
Routed to Link DP1 : Drainage System #1

Routing by Stor-Ind method, Time Span= 0.00-48.00 hrs, dt= 0.01 hrs
Peak Elev= 24.96' @ 12.07 hrs

Device	Routing	Invert	Outlet Devices
#1	Primary	17.69'	15.0" Round CMP_Round 15" L= 200.0' CMP, square edge headwall, Ke= 0.500 Inlet / Outlet Invert= 17.69' / 14.69' S= 0.0150 1' Cc= 0.900 n= 0.025 Corrugated metal, Flow Area= 1.23 sf

Primary OutFlow Max=6.82 cfs @ 12.07 hrs HW=24.94' (Free Discharge)
↑1=CMP_Round 15" (Barrel Controls 6.82 cfs @ 5.56 fps)

Summary for Pond 2a: CB2a

[57] Hint: Peaked at 23.45' (Flood elevation advised)

Inflow Area = 88,069 sf, 45.42% Impervious, Inflow Depth = 3.19" for 25-yr event
Inflow = 4.23 cfs @ 12.39 hrs, Volume= 23,439 cf
Outflow = 4.23 cfs @ 12.39 hrs, Volume= 23,439 cf, Atten= 0%, Lag= 0.0 min
Primary = 4.23 cfs @ 12.39 hrs, Volume= 23,439 cf
Routed to Pond 2b : CB2b

Routing by Stor-Ind method, Time Span= 0.00-48.00 hrs, dt= 0.01 hrs

Existing Conditions 2015-09-24

Prepared by Haley Ward

HydroCAD® 10.20-3g s/n 00801 © 2023 HydroCAD Software Solutions LLC

Type III 24-hr 25-yr Rainfall=7.13"

Printed 11/17/2023

Page 33

Peak Elev= 23.45' @ 12.39 hrs

Device	Routing	Invert	Outlet Devices
#1	Primary	18.94'	12.0" Round CMP_Round 12" L= 54.0' CMP, square edge headwall, Ke= 0.500 Inlet / Outlet Invert= 18.94' / 18.94' S= 0.0000 '/ Cc= 0.900 n= 0.025 Corrugated metal, Flow Area= 0.79 sf

Primary OutFlow Max=4.23 cfs @ 12.39 hrs HW=23.44' (Free Discharge)

↑1=CMP_Round 12" (Barrel Controls 4.23 cfs @ 5.39 fps)

Summary for Pond 2b: CB2b

[57] Hint: Peaked at 23.96' (Flood elevation advised)

[81] Warning: Exceeded Pond 2a by 2.66' @ 12.08 hrs

Inflow Area = 104,729 sf, 52.19% Impervious, Inflow Depth = 3.65" for 25-yr event
Inflow = 5.05 cfs @ 12.36 hrs, Volume= 31,862 cf
Outflow = 5.05 cfs @ 12.36 hrs, Volume= 31,862 cf, Atten= 0%, Lag= 0.0 min
Primary = 5.05 cfs @ 12.36 hrs, Volume= 31,862 cf
Routed to Pond 2c : CB2c

Routing by Stor-Ind method, Time Span= 0.00-48.00 hrs, dt= 0.01 hrs

Peak Elev= 23.96' @ 12.36 hrs

Device	Routing	Invert	Outlet Devices
#1	Primary	18.34'	15.0" Round CMP_Round 15" L= 200.0' CMP, square edge headwall, Ke= 0.500 Inlet / Outlet Invert= 18.34' / 17.78' S= 0.0028 '/ Cc= 0.900 n= 0.025 Corrugated metal, Flow Area= 1.23 sf

Primary OutFlow Max=5.05 cfs @ 12.36 hrs HW=23.96' (Free Discharge)

↑1=CMP_Round 15" (Barrel Controls 5.05 cfs @ 4.11 fps)

Summary for Pond 2c: CB2c

[57] Hint: Peaked at 32.62' (Flood elevation advised)

[81] Warning: Exceeded Pond 2b by 9.04' @ 12.08 hrs

Inflow Area = 120,771 sf, 57.50% Impervious, Inflow Depth = 4.00" for 25-yr event
Inflow = 7.42 cfs @ 12.08 hrs, Volume= 40,284 cf
Outflow = 7.42 cfs @ 12.08 hrs, Volume= 40,284 cf, Atten= 0%, Lag= 0.0 min
Primary = 7.42 cfs @ 12.08 hrs, Volume= 40,284 cf
Routed to Pond 2d : CB2d

Routing by Stor-Ind method, Time Span= 0.00-48.00 hrs, dt= 0.01 hrs

Peak Elev= 32.62' @ 12.08 hrs

Device	Routing	Invert	Outlet Devices
#1	Primary	17.80'	15.0" Round CMP_Round 15" L= 375.0' CMP, square edge headwall, Ke= 0.500

Existing Conditions 2015-09-24

Prepared by Haley Ward

HydroCAD® 10.20-3g s/n 00801 © 2023 HydroCAD Software Solutions LLC

Type III 24-hr 25-yr Rainfall=7.13"

Printed 11/17/2023

Page 34

Inlet / Outlet Invert= 17.80' / 12.18' S= 0.0150 '/ n= 0.025 Corrugated metal, Flow Area= 1.23 sf Cc= 0.900

Primary OutFlow Max=7.41 cfs @ 12.08 hrs HW=32.60' (Free Discharge)

↑1=CMP_Round 15" (Barrel Controls 7.41 cfs @ 6.04 fps)

Summary for Pond 2d: CB2d

[57] Hint: Peaked at 25.78' (Flood elevation advised)

[81] Warning: Exceeded Pond 2c by 1.35' @ 11.98 hrs

Inflow Area = 128,112 sf, 59.69% Impervious, Inflow Depth = 4.15" for 25-yr event
Inflow = 8.61 cfs @ 12.08 hrs, Volume= 44,282 cf
Outflow = 8.61 cfs @ 12.08 hrs, Volume= 44,282 cf, Atten= 0%, Lag= 0.0 min
Primary = 8.61 cfs @ 12.08 hrs, Volume= 44,282 cf
Routed to Link DP2 : Drainage System #2

Routing by Stor-Ind method, Time Span= 0.00-48.00 hrs, dt= 0.01 hrs
Peak Elev= 25.78' @ 12.08 hrs

Device	Routing	Invert	Outlet Devices
#1	Primary	17.29'	15.0" Round CMP_Round 15" L= 100.0' CMP, square edge headwall, Ke= 0.500 Inlet / Outlet Invert= 17.29' / 16.79' S= 0.0050 '/ n= 0.025 Corrugated metal, Flow Area= 1.23 sf Cc= 0.900

Primary OutFlow Max=8.60 cfs @ 12.08 hrs HW=25.76' (Free Discharge)

↑1=CMP_Round 15" (Barrel Controls 8.60 cfs @ 7.01 fps)

Summary for Link DP1: Drainage System #1

Inflow Area = 51,214 sf, 80.59% Impervious, Inflow Depth = 5.57" for 25-yr event
Inflow = 7.50 cfs @ 12.07 hrs, Volume= 23,776 cf
Primary = 7.50 cfs @ 12.07 hrs, Volume= 23,776 cf, Atten= 0%, Lag= 0.0 min
Routed to nonexistent node 2R

Primary outflow = Inflow, Time Span= 0.00-48.00 hrs, dt= 0.01 hrs

Summary for Link DP2: Drainage System #2

Inflow Area = 137,689 sf, 57.62% Impervious, Inflow Depth = 4.03" for 25-yr event
Inflow = 9.22 cfs @ 12.08 hrs, Volume= 46,197 cf
Primary = 9.22 cfs @ 12.08 hrs, Volume= 46,197 cf, Atten= 0%, Lag= 0.0 min
Routed to nonexistent node 2R

Primary outflow = Inflow, Time Span= 0.00-48.00 hrs, dt= 0.01 hrs

Existing Conditions 2015-09-24

Prepared by Haley Ward

HydroCAD® 10.20-3g s/n 00801 © 2023 HydroCAD Software Solutions LLC

Type III 24-hr 50-yr Rainfall=8.53"

Printed 11/17/2023

Page 35

Time span=0.00-48.00 hrs, dt=0.01 hrs, 4801 points
 Runoff by SCS TR-20 method, UH=SCS, Weighted-CN
 Reach routing by Stor-Ind+Trans method - Pond routing by Stor-Ind method

Subcatchment E1a: PS1a	Runoff Area=20,120 sf 65.08% Impervious Runoff Depth=5.76" Tc=5.0 min CN=77 Runoff=3.20 cfs 9,662 cf
Subcatchment E1b: PS1b	Runoff Area=27,062 sf 89.28% Impervious Runoff Depth=7.57" Tc=5.0 min CN=92 Runoff=5.23 cfs 17,068 cf
Subcatchment E1c: PS1c	Runoff Area=4,032 sf 99.58% Impervious Runoff Depth=8.29" Tc=5.0 min CN=98 Runoff=0.80 cfs 2,785 cf
Subcatchment E2a: PS2a	Runoff Area=8,301 sf 41.78% Impervious Runoff Depth=4.21" Tc=5.0 min CN=64 Runoff=0.97 cfs 2,911 cf
Subcatchment E2b: PS2b	Runoff Area=16,660 sf 87.98% Impervious Runoff Depth=7.45" Tc=5.0 min CN=91 Runoff=3.20 cfs 10,340 cf
Subcatchment E2c: PS2c	Runoff Area=16,042 sf 92.13% Impervious Runoff Depth=7.69" Tc=5.0 min CN=93 Runoff=3.12 cfs 10,279 cf
Subcatchment E2d: PS2d	Runoff Area=7,341 sf 95.70% Impervious Runoff Depth=7.93" Tc=5.0 min CN=95 Runoff=1.45 cfs 4,851 cf
Subcatchment E3: PS3	Runoff Area=9,577 sf 29.98% Impervious Runoff Depth=3.38" Tc=5.0 min CN=57 Runoff=0.89 cfs 2,701 cf
Subcatchment O1: Off-Site	Runoff Area=79,768 sf 45.80% Impervious Runoff Depth=4.33" Flow Length=584' Tc=27.6 min CN=65 Runoff=5.43 cfs 28,763 cf
Pond 1a: CB1a	Peak Elev=25.41' Inflow=3.20 cfs 9,662 cf 12.0" Round Culvert n=0.025 L=203.0' S=0.0126 '/' Outflow=3.20 cfs 9,662 cf
Pond 1b: CB1b	Peak Elev=29.69' Inflow=8.43 cfs 26,730 cf 15.0" Round Culvert n=0.025 L=200.0' S=0.0150 '/' Outflow=8.43 cfs 26,730 cf
Pond 2a: CB2a	Peak Elev=26.44' Inflow=5.76 cfs 31,674 cf 12.0" Round Culvert n=0.025 L=54.0' S=0.0000 '/' Outflow=5.76 cfs 31,674 cf
Pond 2b: CB2b	Peak Elev=27.87' Inflow=6.76 cfs 42,014 cf 15.0" Round Culvert n=0.025 L=200.0' S=0.0028 '/' Outflow=6.76 cfs 42,014 cf
Pond 2c: CB2c	Peak Elev=44.52' Inflow=9.44 cfs 52,293 cf 15.0" Round Culvert n=0.025 L=375.0' S=0.0150 '/' Outflow=9.44 cfs 52,293 cf
Pond 2d: CB2d	Peak Elev=30.39' Inflow=10.88 cfs 57,144 cf 15.0" Round Culvert n=0.025 L=100.0' S=0.0050 '/' Outflow=10.88 cfs 57,144 cf
Link DP1: Drainage System #1	Inflow=9.24 cfs 29,516 cf Primary=9.24 cfs 29,516 cf

Existing Conditions 2015-09-24

Prepared by Haley Ward

HydroCAD® 10.20-3g s/n 00801 © 2023 HydroCAD Software Solutions LLC

Type III 24-hr 50-yr Rainfall=8.53"

Printed 11/17/2023

Page 36

Link DP2: Drainage System #2

Inflow=11.76 cfs 59,845 cf

Primary=11.76 cfs 59,845 cf

Total Runoff Area = 188,903 sf Runoff Volume = 89,361 cf Average Runoff Depth = 5.68"
36.15% Pervious = 68,294 sf 63.85% Impervious = 120,609 sf

Existing Conditions 2015-09-24

Prepared by Haley Ward

HydroCAD® 10.20-3g s/n 00801 © 2023 HydroCAD Software Solutions LLC

Type III 24-hr 50-yr Rainfall=8.53"

Printed 11/17/2023

Page 37

Summary for Subcatchment E1a: PS1a

Runoff = 3.20 cfs @ 12.07 hrs, Volume= 9,662 cf, Depth= 5.76"
Routed to Pond 1a : CB1a

Runoff by SCS TR-20 method, UH=SCS, Weighted-CN, Time Span= 0.00-48.00 hrs, dt= 0.01 hrs
Type III 24-hr 50-yr Rainfall=8.53"

Area (sf)	CN	Description
4,566	98	Roofs, HSG A
7,025	39	>75% Grass cover, Good, HSG A
8,529	98	Paved parking, HSG A
20,120	77	Weighted Average
7,025		34.92% Pervious Area
13,095		65.08% Impervious Area

Tc (min)	Length (feet)	Slope (ft/ft)	Velocity (ft/sec)	Capacity (cfs)	Description
5.0					Direct Entry,

Summary for Subcatchment E1b: PS1b

Runoff = 5.23 cfs @ 12.07 hrs, Volume= 17,068 cf, Depth= 7.57"
Routed to Pond 1b : CB1b

Runoff by SCS TR-20 method, UH=SCS, Weighted-CN, Time Span= 0.00-48.00 hrs, dt= 0.01 hrs
Type III 24-hr 50-yr Rainfall=8.53"

Area (sf)	CN	Description
2,901	39	>75% Grass cover, Good, HSG A
3,319	98	Roofs, HSG A
20,842	98	Paved parking, HSG A
27,062	92	Weighted Average
2,901		10.72% Pervious Area
24,161		89.28% Impervious Area

Tc (min)	Length (feet)	Slope (ft/ft)	Velocity (ft/sec)	Capacity (cfs)	Description
5.0					Direct Entry,

Summary for Subcatchment E1c: PS1c

Runoff = 0.80 cfs @ 12.07 hrs, Volume= 2,785 cf, Depth= 8.29"
Routed to Link DP1 : Drainage System #1

Runoff by SCS TR-20 method, UH=SCS, Weighted-CN, Time Span= 0.00-48.00 hrs, dt= 0.01 hrs
Type III 24-hr 50-yr Rainfall=8.53"

Existing Conditions 2015-09-24

Type III 24-hr 50-yr Rainfall=8.53"

Prepared by Haley Ward

Printed 11/17/2023

HydroCAD® 10.20-3g s/n 00801 © 2023 HydroCAD Software Solutions LLC

Page 38

Area (sf)	CN	Description
17	39	>75% Grass cover, Good, HSG A
4,015	98	Paved parking, HSG A
4,032	98	Weighted Average
17		0.42% Pervious Area
4,015		99.58% Impervious Area

Tc (min)	Length (feet)	Slope (ft/ft)	Velocity (ft/sec)	Capacity (cfs)	Description
5.0					Direct Entry,

Summary for Subcatchment E2a: PS2a

Runoff = 0.97 cfs @ 12.08 hrs, Volume= 2,911 cf, Depth= 4.21"
 Routed to Pond 2a : CB2a

Runoff by SCS TR-20 method, UH=SCS, Weighted-CN, Time Span= 0.00-48.00 hrs, dt= 0.01 hrs
 Type III 24-hr 50-yr Rainfall=8.53"

Area (sf)	CN	Description
56	98	Roofs, HSG A
4,833	39	>75% Grass cover, Good, HSG A
3,412	98	Paved parking, HSG A
8,301	64	Weighted Average
4,833		58.22% Pervious Area
3,468		41.78% Impervious Area

Tc (min)	Length (feet)	Slope (ft/ft)	Velocity (ft/sec)	Capacity (cfs)	Description
5.0					Direct Entry,

Summary for Subcatchment E2b: PS2b

Runoff = 3.20 cfs @ 12.07 hrs, Volume= 10,340 cf, Depth= 7.45"
 Routed to Pond 2b : CB2b

Runoff by SCS TR-20 method, UH=SCS, Weighted-CN, Time Span= 0.00-48.00 hrs, dt= 0.01 hrs
 Type III 24-hr 50-yr Rainfall=8.53"

Area (sf)	CN	Description
3,630	98	Roofs, HSG A
2,003	39	>75% Grass cover, Good, HSG A
11,027	98	Paved parking, HSG A
16,660	91	Weighted Average
2,003		12.02% Pervious Area
14,657		87.98% Impervious Area

Existing Conditions 2015-09-24

Type III 24-hr 50-yr Rainfall=8.53"

Prepared by Haley Ward

Printed 11/17/2023

HydroCAD® 10.20-3g s/n 00801 © 2023 HydroCAD Software Solutions LLC

Page 39

Tc (min)	Length (feet)	Slope (ft/ft)	Velocity (ft/sec)	Capacity (cfs)	Description
5.0					Direct Entry,

Summary for Subcatchment E2c: PS2c

Runoff = 3.12 cfs @ 12.07 hrs, Volume= 10,279 cf, Depth= 7.69"
Routed to Pond 2c : CB2c

Runoff by SCS TR-20 method, UH=SCS, Weighted-CN, Time Span= 0.00-48.00 hrs, dt= 0.01 hrs
Type III 24-hr 50-yr Rainfall=8.53"

Area (sf)	CN	Description
4,423	98	Roofs, HSG A
1,262	39	>75% Grass cover, Good, HSG A
10,357	98	Paved parking, HSG A
16,042	93	Weighted Average
1,262		7.87% Pervious Area
14,780		92.13% Impervious Area

Tc (min)	Length (feet)	Slope (ft/ft)	Velocity (ft/sec)	Capacity (cfs)	Description
5.0					Direct Entry,

Summary for Subcatchment E2d: PS2d

Runoff = 1.45 cfs @ 12.07 hrs, Volume= 4,851 cf, Depth= 7.93"
Routed to Pond 2d : CB2d

Runoff by SCS TR-20 method, UH=SCS, Weighted-CN, Time Span= 0.00-48.00 hrs, dt= 0.01 hrs
Type III 24-hr 50-yr Rainfall=8.53"

Area (sf)	CN	Description
316	39	>75% Grass cover, Good, HSG A
7,025	98	Paved parking, HSG A
7,341	95	Weighted Average
316		4.30% Pervious Area
7,025		95.70% Impervious Area

Tc (min)	Length (feet)	Slope (ft/ft)	Velocity (ft/sec)	Capacity (cfs)	Description
5.0					Direct Entry,

Summary for Subcatchment E3: PS3

Runoff = 0.89 cfs @ 12.08 hrs, Volume= 2,701 cf, Depth= 3.38"
Routed to Link DP2 : Drainage System #2

Runoff by SCS TR-20 method, UH=SCS, Weighted-CN, Time Span= 0.00-48.00 hrs, dt= 0.01 hrs
Type III 24-hr 50-yr Rainfall=8.53"

Existing Conditions 2015-09-24

Prepared by Haley Ward

HydroCAD® 10.20-3g s/n 00801 © 2023 HydroCAD Software Solutions LLC

Type III 24-hr 50-yr Rainfall=8.53"

Printed 11/17/2023

Page 40

Area (sf)	CN	Description
6,706	39	>75% Grass cover, Good, HSG A
2,871	98	Paved parking, HSG A
9,577	57	Weighted Average
6,706		70.02% Pervious Area
2,871		29.98% Impervious Area

Tc (min)	Length (feet)	Slope (ft/ft)	Velocity (ft/sec)	Capacity (cfs)	Description
5.0					Direct Entry,

Summary for Subcatchment O1: Off-Site

[47] Hint: Peak is 249% of capacity of segment #3

Runoff = 5.43 cfs @ 12.39 hrs, Volume= 28,763 cf, Depth= 4.33"
 Routed to Pond 2a : CB2a

Runoff by SCS TR-20 method, UH=SCS, Weighted-CN, Time Span= 0.00-48.00 hrs, dt= 0.01 hrs
 Type III 24-hr 50-yr Rainfall=8.53"

Area (sf)	CN	Description
2,453	98	Unconnected roofs, HSG A
34,084	98	Paved parking, HSG A
22,052	36	Woods, Fair, HSG A
21,179	39	>75% Grass cover, Good, HSG A
79,768	65	Weighted Average
43,231		54.20% Pervious Area
36,537		45.80% Impervious Area
2,453		6.71% Unconnected

Tc (min)	Length (feet)	Slope (ft/ft)	Velocity (ft/sec)	Capacity (cfs)	Description
19.6	100	0.0250	0.08		Sheet Flow, Woods: Light underbrush n= 0.400 P2= 3.20"
7.3	374	0.0150	0.86		Shallow Concentrated Flow, Short Grass Pasture Kv= 7.0 fps
0.7	110	0.0050	2.78	2.18	Pipe Channel, RCP_Round 12" 12.0" Round Area= 0.8 sf Perim= 3.1' r= 0.25' n= 0.015 Concrete sewer w/manholes & inlets
27.6	584	Total			

Summary for Pond 1a: CB1a

[57] Hint: Peaked at 25.41' (Flood elevation advised)

Existing Conditions 2015-09-24

Prepared by Haley Ward

HydroCAD® 10.20-3g s/n 00801 © 2023 HydroCAD Software Solutions LLC

Type III 24-hr 50-yr Rainfall=8.53"

Printed 11/17/2023

Page 41

Inflow Area = 20,120 sf, 65.08% Impervious, Inflow Depth = 5.76" for 50-yr event
Inflow = 3.20 cfs @ 12.07 hrs, Volume= 9,662 cf
Outflow = 3.20 cfs @ 12.07 hrs, Volume= 9,662 cf, Atten= 0%, Lag= 0.0 min
Primary = 3.20 cfs @ 12.07 hrs, Volume= 9,662 cf
Routed to Pond 1b : CB1b

Routing by Stor-Ind method, Time Span= 0.00-48.00 hrs, dt= 0.01 hrs
Peak Elev= 25.41' @ 12.07 hrs

Device	Routing	Invert	Outlet Devices
#1	Primary	20.49'	12.0" Round CMP_Round 12" L= 203.0' CMP, square edge headwall, Ke= 0.500 Inlet / Outlet Invert= 20.49' / 17.94' S= 0.0126 1' Cc= 0.900 n= 0.025 Corrugated metal, Flow Area= 0.79 sf

Primary OutFlow Max=3.19 cfs @ 12.07 hrs HW=25.38' (Free Discharge)
↑1=CMP_Round 12" (Barrel Controls 3.19 cfs @ 4.07 fps)

Summary for Pond 1b: CB1b

[57] Hint: Peaked at 29.69' (Flood elevation advised)
[81] Warning: Exceeded Pond 1a by 4.29' @ 12.07 hrs

Inflow Area = 47,182 sf, 78.96% Impervious, Inflow Depth = 6.80" for 50-yr event
Inflow = 8.43 cfs @ 12.07 hrs, Volume= 26,730 cf
Outflow = 8.43 cfs @ 12.07 hrs, Volume= 26,730 cf, Atten= 0%, Lag= 0.0 min
Primary = 8.43 cfs @ 12.07 hrs, Volume= 26,730 cf
Routed to Link DP1 : Drainage System #1

Routing by Stor-Ind method, Time Span= 0.00-48.00 hrs, dt= 0.01 hrs
Peak Elev= 29.69' @ 12.07 hrs

Device	Routing	Invert	Outlet Devices
#1	Primary	17.69'	15.0" Round CMP_Round 15" L= 200.0' CMP, square edge headwall, Ke= 0.500 Inlet / Outlet Invert= 17.69' / 14.69' S= 0.0150 1' Cc= 0.900 n= 0.025 Corrugated metal, Flow Area= 1.23 sf

Primary OutFlow Max=8.42 cfs @ 12.07 hrs HW=29.66' (Free Discharge)
↑1=CMP_Round 15" (Barrel Controls 8.42 cfs @ 6.87 fps)

Summary for Pond 2a: CB2a

[57] Hint: Peaked at 26.44' (Flood elevation advised)

Inflow Area = 88,069 sf, 45.42% Impervious, Inflow Depth = 4.32" for 50-yr event
Inflow = 5.76 cfs @ 12.37 hrs, Volume= 31,674 cf
Outflow = 5.76 cfs @ 12.37 hrs, Volume= 31,674 cf, Atten= 0%, Lag= 0.0 min
Primary = 5.76 cfs @ 12.37 hrs, Volume= 31,674 cf
Routed to Pond 2b : CB2b

Routing by Stor-Ind method, Time Span= 0.00-48.00 hrs, dt= 0.01 hrs

Existing Conditions 2015-09-24

Prepared by Haley Ward

HydroCAD® 10.20-3g s/n 00801 © 2023 HydroCAD Software Solutions LLC

Type III 24-hr 50-yr Rainfall=8.53"

Printed 11/17/2023

Page 42

Peak Elev= 26.44' @ 12.37 hrs

Device	Routing	Invert	Outlet Devices
#1	Primary	18.94'	12.0" Round CMP_Round 12" L= 54.0' CMP, square edge headwall, Ke= 0.500 Inlet / Outlet Invert= 18.94' / 18.94' S= 0.0000 '/ Cc= 0.900 n= 0.025 Corrugated metal, Flow Area= 0.79 sf

Primary OutFlow Max=5.76 cfs @ 12.37 hrs HW=26.44' (Free Discharge)

↑1=CMP_Round 12" (Barrel Controls 5.76 cfs @ 7.34 fps)

Summary for Pond 2b: CB2b

[57] Hint: Peaked at 27.87' (Flood elevation advised)

[81] Warning: Exceeded Pond 2a by 4.90' @ 12.08 hrs

Inflow Area = 104,729 sf, 52.19% Impervious, Inflow Depth = 4.81" for 50-yr event
 Inflow = 6.76 cfs @ 12.36 hrs, Volume= 42,014 cf
 Outflow = 6.76 cfs @ 12.36 hrs, Volume= 42,014 cf, Atten= 0%, Lag= 0.0 min
 Primary = 6.76 cfs @ 12.36 hrs, Volume= 42,014 cf
 Routed to Pond 2c : CB2c

Routing by Stor-Ind method, Time Span= 0.00-48.00 hrs, dt= 0.01 hrs

Peak Elev= 27.87' @ 12.36 hrs

Device	Routing	Invert	Outlet Devices
#1	Primary	18.34'	15.0" Round CMP_Round 15" L= 200.0' CMP, square edge headwall, Ke= 0.500 Inlet / Outlet Invert= 18.34' / 17.78' S= 0.0028 '/ Cc= 0.900 n= 0.025 Corrugated metal, Flow Area= 1.23 sf

Primary OutFlow Max=6.76 cfs @ 12.36 hrs HW=27.86' (Free Discharge)

↑1=CMP_Round 15" (Barrel Controls 6.76 cfs @ 5.51 fps)

Summary for Pond 2c: CB2c

[57] Hint: Peaked at 44.52' (Flood elevation advised)

[81] Warning: Exceeded Pond 2b by 17.71' @ 12.08 hrs

Inflow Area = 120,771 sf, 57.50% Impervious, Inflow Depth = 5.20" for 50-yr event
 Inflow = 9.44 cfs @ 12.08 hrs, Volume= 52,293 cf
 Outflow = 9.44 cfs @ 12.08 hrs, Volume= 52,293 cf, Atten= 0%, Lag= 0.0 min
 Primary = 9.44 cfs @ 12.08 hrs, Volume= 52,293 cf
 Routed to Pond 2d : CB2d

Routing by Stor-Ind method, Time Span= 0.00-48.00 hrs, dt= 0.01 hrs

Peak Elev= 44.52' @ 12.08 hrs

Device	Routing	Invert	Outlet Devices
#1	Primary	17.80'	15.0" Round CMP_Round 15" L= 375.0' CMP, square edge headwall, Ke= 0.500

Existing Conditions 2015-09-24

Prepared by Haley Ward

HydroCAD® 10.20-3g s/n 00801 © 2023 HydroCAD Software Solutions LLC

Type III 24-hr 50-yr Rainfall=8.53"

Printed 11/17/2023

Page 43

Inlet / Outlet Invert= 17.80' / 12.18' S= 0.0150 '/ n= 0.025 Corrugated metal, Flow Area= 1.23 sf Cc= 0.900

Primary OutFlow Max=9.44 cfs @ 12.08 hrs HW=44.50' (Free Discharge)

↑1=CMP_Round 15" (Barrel Controls 9.44 cfs @ 7.69 fps)

Summary for Pond 2d: CB2d

[57] Hint: Peaked at 30.39' (Flood elevation advised)

[81] Warning: Exceeded Pond 2c by 1.30' @ 11.94 hrs

Inflow Area = 128,112 sf, 59.69% Impervious, Inflow Depth = 5.35" for 50-yr event
Inflow = 10.88 cfs @ 12.08 hrs, Volume= 57,144 cf
Outflow = 10.88 cfs @ 12.08 hrs, Volume= 57,144 cf, Atten= 0%, Lag= 0.0 min
Primary = 10.88 cfs @ 12.08 hrs, Volume= 57,144 cf

Routed to Link DP2 : Drainage System #2

Routing by Stor-Ind method, Time Span= 0.00-48.00 hrs, dt= 0.01 hrs

Peak Elev= 30.39' @ 12.08 hrs

Device	Routing	Invert	Outlet Devices
#1	Primary	17.29'	15.0" Round CMP_Round 15" L= 100.0' CMP, square edge headwall, Ke= 0.500 Inlet / Outlet Invert= 17.29' / 16.79' S= 0.0050 '/ Cc= 0.900 n= 0.025 Corrugated metal, Flow Area= 1.23 sf

Primary OutFlow Max=10.87 cfs @ 12.08 hrs HW=30.36' (Free Discharge)

↑1=CMP_Round 15" (Barrel Controls 10.87 cfs @ 8.85 fps)

Summary for Link DP1: Drainage System #1

Inflow Area = 51,214 sf, 80.59% Impervious, Inflow Depth = 6.92" for 50-yr event
Inflow = 9.24 cfs @ 12.07 hrs, Volume= 29,516 cf
Primary = 9.24 cfs @ 12.07 hrs, Volume= 29,516 cf, Atten= 0%, Lag= 0.0 min

Routed to nonexistent node 2R

Primary outflow = Inflow, Time Span= 0.00-48.00 hrs, dt= 0.01 hrs

Summary for Link DP2: Drainage System #2

Inflow Area = 137,689 sf, 57.62% Impervious, Inflow Depth = 5.22" for 50-yr event
Inflow = 11.76 cfs @ 12.08 hrs, Volume= 59,845 cf
Primary = 11.76 cfs @ 12.08 hrs, Volume= 59,845 cf, Atten= 0%, Lag= 0.0 min

Routed to nonexistent node 2R

Primary outflow = Inflow, Time Span= 0.00-48.00 hrs, dt= 0.01 hrs

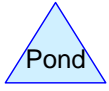
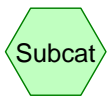
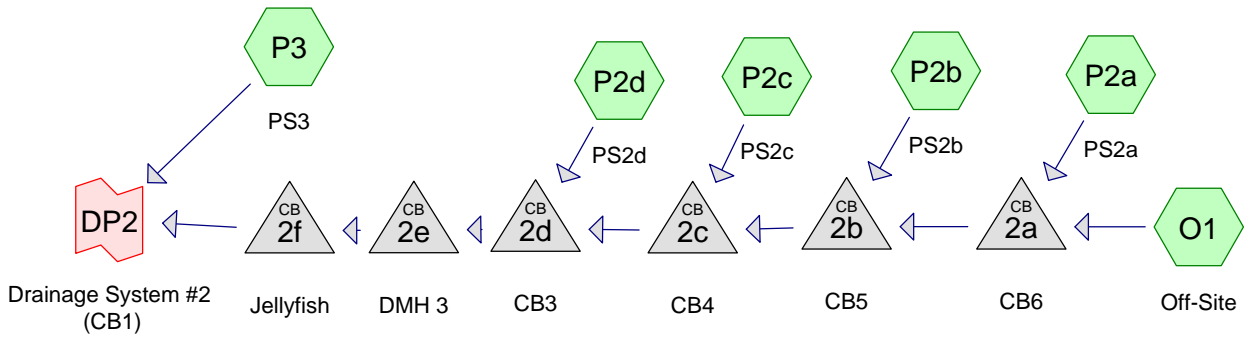
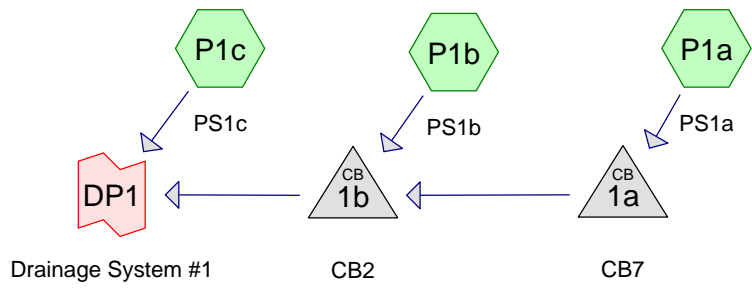

Routing Diagram for Proposed Conditions 2023-09-19
 Prepared by Haley Ward, Printed 11/17/2023
 HydroCAD® 10.20-3g s/n 00801 © 2023 HydroCAD Software Solutions LLC

Project Notes

Defined 5 rainfall events from extreme_precip_tables_output IDF

Proposed Conditions 2023-09-19

Prepared by Haley Ward

HydroCAD® 10.20-3g s/n 00801 © 2023 HydroCAD Software Solutions LLC

Printed 11/17/2023

Page 3

Rainfall Events Listing (selected events)

Event#	Event Name	Storm Type	Curve	Mode	Duration (hours)	B/B	Depth (inches)	AMC
1	2-yr	Type III 24-hr		Default	24.00	1	3.70	2
2	10-yr	Type III 24-hr		Default	24.00	1	5.62	2
3	25-yr	Type III 24-hr		Default	24.00	1	7.13	2
4	50-yr	Type III 24-hr		Default	24.00	1	8.53	2

Proposed Conditions 2023-09-19

Prepared by Haley Ward

HydroCAD® 10.20-3g s/n 00801 © 2023 HydroCAD Software Solutions LLC

Printed 11/17/2023

Page 4

Area Listing (all nodes)

Area (sq-ft)	CN	Description (subcatchment-numbers)
42,228	39	>75% Grass cover, Good, HSG A (O1, P1a, P1b, P1c, P2a, P2b, P3)
78,614	98	Paved parking, HSG A (O1, P1a, P1b, P1c, P2a, P2b, P2c, P2d, P3)
43,554	98	Roofs, HSG A (P1a, P1b, P2a, P2b, P2c, P2d)
2,453	98	Unconnected roofs, HSG A (O1)
22,052	36	Woods, Fair, HSG A (O1)
188,901	78	TOTAL AREA

Proposed Conditions 2023-09-19

Prepared by Haley Ward

HydroCAD® 10.20-3g s/n 00801 © 2023 HydroCAD Software Solutions LLC

Printed 11/17/2023

Page 5

Soil Listing (all nodes)

Area (sq-ft)	Soil Group	Subcatchment Numbers
188,901	HSG A	O1, P1a, P1b, P1c, P2a, P2b, P2c, P2d, P3
0	HSG B	
0	HSG C	
0	HSG D	
0	Other	
188,901		TOTAL AREA

Proposed Conditions 2023-09-19

Prepared by Haley Ward

HydroCAD® 10.20-3g s/n 00801 © 2023 HydroCAD Software Solutions LLC

Printed 11/17/2023

Page 6

Ground Covers (all nodes)

HSG-A (sq-ft)	HSG-B (sq-ft)	HSG-C (sq-ft)	HSG-D (sq-ft)	Other (sq-ft)	Total (sq-ft)	Ground Cover	Sub Num
42,228	0	0	0	0	42,228	>75% Grass cover, Good	
78,614	0	0	0	0	78,614	Paved parking	
43,554	0	0	0	0	43,554	Roofs	
2,453	0	0	0	0	2,453	Unconnected roofs	
22,052	0	0	0	0	22,052	Woods, Fair	
188,901	0	0	0	0	188,901	TOTAL AREA	

Proposed Conditions 2023-09-19

Prepared by Haley Ward

HydroCAD® 10.20-3g s/n 00801 © 2023 HydroCAD Software Solutions LLC

Printed 11/17/2023

Page 7

Pipe Listing (all nodes)

Line#	Node Number	In-Invert (feet)	Out-Invert (feet)	Length (feet)	Slope (ft/ft)	n	Width (inches)	Diam/Height (inches)	Inside-Fill (inches)	Node Name
1	O1	0.00	0.00	110.0	0.0050	0.015	0.0	12.0	0.0	
2	1a	21.06	18.00	183.0	0.0167	0.013	0.0	12.0	0.0	
3	1b	17.95	17.81	90.0	0.0016	0.013	0.0	15.0	0.0	
4	2a	18.09	18.02	58.0	0.0012	0.013	0.0	18.0	0.0	
5	2b	18.02	17.90	96.0	0.0013	0.013	0.0	18.0	0.0	
6	2c	17.90	17.80	81.0	0.0012	0.013	0.0	18.0	0.0	
7	2d	17.70	17.69	7.0	0.0014	0.013	0.0	18.0	0.0	
8	2e	17.44	17.41	36.0	0.0008	0.013	0.0	24.0	0.0	
9	2f	17.31	17.29	22.0	0.0009	0.013	0.0	24.0	0.0	

Proposed Conditions 2023-09-19

Type III 24-hr 2-yr Rainfall=3.70"

Prepared by Haley Ward

Printed 11/17/2023

HydroCAD® 10.20-3g s/n 00801 © 2023 HydroCAD Software Solutions LLC

Page 8

Time span=0.00-48.00 hrs, dt=0.01 hrs, 4801 points
 Runoff by SCS TR-20 method, UH=SCS, Weighted-CN
 Reach routing by Stor-Ind+Trans method - Pond routing by Stor-Ind method

Subcatchment O1: Off-Site	Runoff Area=79,768 sf 45.80% Impervious Runoff Depth=0.86" Flow Length=584' Tc=27.6 min CN=65 Runoff=0.93 cfs 5,712 cf
Subcatchment P1a: PS1a	Runoff Area=20,120 sf 64.85% Impervious Runoff Depth=1.58" Tc=5.0 min CN=77 Runoff=0.88 cfs 2,650 cf
Subcatchment P1b: PS1b	Runoff Area=26,173 sf 92.50% Impervious Runoff Depth=3.03" Tc=5.0 min CN=94 Runoff=2.10 cfs 6,610 cf
Subcatchment P1c: PS1c	Runoff Area=4,594 sf 99.65% Impervious Runoff Depth=3.47" Tc=5.0 min CN=98 Runoff=0.39 cfs 1,327 cf
Subcatchment P2a: PS2a	Runoff Area=8,300 sf 30.05% Impervious Runoff Depth=0.49" Tc=5.0 min CN=57 Runoff=0.07 cfs 341 cf
Subcatchment P2b: PS2b	Runoff Area=16,660 sf 89.99% Impervious Runoff Depth=2.83" Tc=5.0 min CN=92 Runoff=1.27 cfs 3,927 cf
Subcatchment P2c: PS2c	Runoff Area=15,044 sf 100.00% Impervious Runoff Depth=3.47" Tc=5.0 min CN=98 Runoff=1.29 cfs 4,345 cf
Subcatchment P2d: PS2d	Runoff Area=8,407 sf 100.00% Impervious Runoff Depth=3.47" Tc=5.0 min CN=98 Runoff=0.72 cfs 2,428 cf
Subcatchment P3: PS3	Runoff Area=9,835 sf 54.01% Impervious Runoff Depth=1.19" Tc=5.0 min CN=71 Runoff=0.31 cfs 978 cf
Pond 1a: CB7	Peak Elev=21.54' Inflow=0.88 cfs 2,650 cf 12.0" Round Culvert n=0.013 L=183.0' S=0.0167 '/' Outflow=0.88 cfs 2,650 cf
Pond 1b: CB2	Peak Elev=19.19' Inflow=2.97 cfs 9,261 cf 15.0" Round Culvert n=0.013 L=90.0' S=0.0016 '/' Outflow=2.97 cfs 9,261 cf
Pond 2a: CB6	Peak Elev=18.70' Inflow=0.97 cfs 6,053 cf 18.0" Round Culvert n=0.013 L=58.0' S=0.0012 '/' Outflow=0.97 cfs 6,053 cf
Pond 2b: CB5	Peak Elev=18.81' Inflow=1.52 cfs 9,980 cf 18.0" Round Culvert n=0.013 L=96.0' S=0.0013 '/' Outflow=1.52 cfs 9,980 cf
Pond 2c: CB4	Peak Elev=18.98' Inflow=2.80 cfs 14,325 cf 18.0" Round Culvert n=0.013 L=81.0' S=0.0012 '/' Outflow=2.80 cfs 14,325 cf
Pond 2d: CB3	Peak Elev=18.83' Inflow=3.52 cfs 16,753 cf 18.0" Round Culvert n=0.013 L=7.0' S=0.0014 '/' Outflow=3.52 cfs 16,753 cf
Pond 2e: DMH 3	Peak Elev=18.50' Inflow=3.52 cfs 16,753 cf 24.0" Round Culvert n=0.013 L=36.0' S=0.0008 '/' Outflow=3.52 cfs 16,753 cf

Proposed Conditions 2023-09-19

Prepared by Haley Ward

HydroCAD® 10.20-3g s/n 00801 © 2023 HydroCAD Software Solutions LLC

Type III 24-hr 2-yr Rainfall=3.70"

Printed 11/17/2023

Page 9

Pond 2f: Jellyfish

Peak Elev=18.35' Inflow=3.52 cfs 16,753 cf
24.0" Round Culvert n=0.013 L=22.0' S=0.0009 '/ Outflow=3.52 cfs 16,753 cf

Link DP1: Drainage System #1

Inflow=3.37 cfs 10,588 cf
Primary=3.37 cfs 10,588 cf

Link DP2: Drainage System #2 (CB1)

Inflow=3.83 cfs 17,731 cf
Primary=3.83 cfs 17,731 cf

Total Runoff Area = 188,901 sf Runoff Volume = 28,318 cf Average Runoff Depth = 1.80"
34.03% Pervious = 64,280 sf 65.97% Impervious = 124,621 sf

Proposed Conditions 2023-09-19

Type III 24-hr 2-yr Rainfall=3.70"

Prepared by Haley Ward

Printed 11/17/2023

HydroCAD® 10.20-3g s/n 00801 © 2023 HydroCAD Software Solutions LLC

Page 10

Summary for Subcatchment O1: Off-Site

Runoff = 0.93 cfs @ 12.45 hrs, Volume= 5,712 cf, Depth= 0.86"
Routed to Pond 2a : CB6

Runoff by SCS TR-20 method, UH=SCS, Weighted-CN, Time Span= 0.00-48.00 hrs, dt= 0.01 hrs
Type III 24-hr 2-yr Rainfall=3.70"

Area (sf)	CN	Description
2,453	98	Unconnected roofs, HSG A
34,084	98	Paved parking, HSG A
22,052	36	Woods, Fair, HSG A
21,179	39	>75% Grass cover, Good, HSG A
79,768	65	Weighted Average
43,231		54.20% Pervious Area
36,537		45.80% Impervious Area
2,453		6.71% Unconnected

Tc (min)	Length (feet)	Slope (ft/ft)	Velocity (ft/sec)	Capacity (cfs)	Description
19.6	100	0.0250	0.08		Sheet Flow, Woods: Light underbrush n= 0.400 P2= 3.20"
7.3	374	0.0150	0.86		Shallow Concentrated Flow, Short Grass Pasture Kv= 7.0 fps
0.7	110	0.0050	2.78	2.18	Pipe Channel, RCP_Round 12" 12.0" Round Area= 0.8 sf Perim= 3.1' r= 0.25' n= 0.015 Concrete sewer w/manholes & inlets
27.6	584	Total			

Summary for Subcatchment P1a: PS1a

Runoff = 0.88 cfs @ 12.08 hrs, Volume= 2,650 cf, Depth= 1.58"
Routed to Pond 1a : CB7

Runoff by SCS TR-20 method, UH=SCS, Weighted-CN, Time Span= 0.00-48.00 hrs, dt= 0.01 hrs
Type III 24-hr 2-yr Rainfall=3.70"

Area (sf)	CN	Description
8,481	98	Paved parking, HSG A
4,566	98	Roofs, HSG A
7,073	39	>75% Grass cover, Good, HSG A
20,120	77	Weighted Average
7,073		35.15% Pervious Area
13,047		64.85% Impervious Area

Tc (min)	Length (feet)	Slope (ft/ft)	Velocity (ft/sec)	Capacity (cfs)	Description
5.0					Direct Entry,

Proposed Conditions 2023-09-19

Prepared by Haley Ward

HydroCAD® 10.20-3g s/n 00801 © 2023 HydroCAD Software Solutions LLC

Type III 24-hr 2-yr Rainfall=3.70"

Printed 11/17/2023

Page 11

Summary for Subcatchment P1b: PS1b

Runoff = 2.10 cfs @ 12.07 hrs, Volume= 6,610 cf, Depth= 3.03"
Routed to Pond 1b : CB2

Runoff by SCS TR-20 method, UH=SCS, Weighted-CN, Time Span= 0.00-48.00 hrs, dt= 0.01 hrs
Type III 24-hr 2-yr Rainfall=3.70"

Area (sf)	CN	Description
10,744	98	Paved parking, HSG A
13,465	98	Roofs, HSG A
1,964	39	>75% Grass cover, Good, HSG A
26,173	94	Weighted Average
1,964		7.50% Pervious Area
24,209		92.50% Impervious Area

Tc (min)	Length (feet)	Slope (ft/ft)	Velocity (ft/sec)	Capacity (cfs)	Description
5.0					Direct Entry,

Summary for Subcatchment P1c: PS1c

Runoff = 0.39 cfs @ 12.07 hrs, Volume= 1,327 cf, Depth= 3.47"
Routed to Link DP1 : Drainage System #1

Runoff by SCS TR-20 method, UH=SCS, Weighted-CN, Time Span= 0.00-48.00 hrs, dt= 0.01 hrs
Type III 24-hr 2-yr Rainfall=3.70"

Area (sf)	CN	Description
4,578	98	Paved parking, HSG A
16	39	>75% Grass cover, Good, HSG A
4,594	98	Weighted Average
16		0.35% Pervious Area
4,578		99.65% Impervious Area

Tc (min)	Length (feet)	Slope (ft/ft)	Velocity (ft/sec)	Capacity (cfs)	Description
5.0					Direct Entry,

Summary for Subcatchment P2a: PS2a

Runoff = 0.07 cfs @ 12.11 hrs, Volume= 341 cf, Depth= 0.49"
Routed to Pond 2a : CB6

Runoff by SCS TR-20 method, UH=SCS, Weighted-CN, Time Span= 0.00-48.00 hrs, dt= 0.01 hrs
Type III 24-hr 2-yr Rainfall=3.70"

Proposed Conditions 2023-09-19

Prepared by Haley Ward

HydroCAD® 10.20-3g s/n 00801 © 2023 HydroCAD Software Solutions LLC

Type III 24-hr 2-yr Rainfall=3.70"

Printed 11/17/2023

Page 12

Area (sf)	CN	Description
2,465	98	Paved parking, HSG A
29	98	Roofs, HSG A
5,806	39	>75% Grass cover, Good, HSG A
8,300	57	Weighted Average
5,806		69.95% Pervious Area
2,494		30.05% Impervious Area

Tc (min)	Length (feet)	Slope (ft/ft)	Velocity (ft/sec)	Capacity (cfs)	Description
5.0					Direct Entry,

Summary for Subcatchment P2b: PS2b

Runoff = 1.27 cfs @ 12.07 hrs, Volume= 3,927 cf, Depth= 2.83"
Routed to Pond 2b : CB5

Runoff by SCS TR-20 method, UH=SCS, Weighted-CN, Time Span= 0.00-48.00 hrs, dt= 0.01 hrs
Type III 24-hr 2-yr Rainfall=3.70"

Area (sf)	CN	Description
6,157	98	Paved parking, HSG A
8,836	98	Roofs, HSG A
1,667	39	>75% Grass cover, Good, HSG A
16,660	92	Weighted Average
1,667		10.01% Pervious Area
14,993		89.99% Impervious Area

Tc (min)	Length (feet)	Slope (ft/ft)	Velocity (ft/sec)	Capacity (cfs)	Description
5.0					Direct Entry,

Summary for Subcatchment P2c: PS2c

Runoff = 1.29 cfs @ 12.07 hrs, Volume= 4,345 cf, Depth= 3.47"
Routed to Pond 2c : CB4

Runoff by SCS TR-20 method, UH=SCS, Weighted-CN, Time Span= 0.00-48.00 hrs, dt= 0.01 hrs
Type III 24-hr 2-yr Rainfall=3.70"

Area (sf)	CN	Description
3,896	98	Paved parking, HSG A
11,148	98	Roofs, HSG A
15,044	98	Weighted Average
15,044		100.00% Impervious Area

Proposed Conditions 2023-09-19

Prepared by Haley Ward

HydroCAD® 10.20-3g s/n 00801 © 2023 HydroCAD Software Solutions LLC

Type III 24-hr 2-yr Rainfall=3.70"

Printed 11/17/2023

Page 13

Tc (min)	Length (feet)	Slope (ft/ft)	Velocity (ft/sec)	Capacity (cfs)	Description
5.0					Direct Entry,

Summary for Subcatchment P2d: PS2d

Runoff = 0.72 cfs @ 12.07 hrs, Volume= 2,428 cf, Depth= 3.47"
Routed to Pond 2d : CB3

Runoff by SCS TR-20 method, UH=SCS, Weighted-CN, Time Span= 0.00-48.00 hrs, dt= 0.01 hrs
Type III 24-hr 2-yr Rainfall=3.70"

Area (sf)	CN	Description
2,897	98	Paved parking, HSG A
5,510	98	Roofs, HSG A
8,407	98	Weighted Average
8,407		100.00% Impervious Area

Tc (min)	Length (feet)	Slope (ft/ft)	Velocity (ft/sec)	Capacity (cfs)	Description
5.0					Direct Entry,

Summary for Subcatchment P3: PS3

Runoff = 0.31 cfs @ 12.08 hrs, Volume= 978 cf, Depth= 1.19"
Routed to Link DP2 : Drainage System #2 (CB1)

Runoff by SCS TR-20 method, UH=SCS, Weighted-CN, Time Span= 0.00-48.00 hrs, dt= 0.01 hrs
Type III 24-hr 2-yr Rainfall=3.70"

Area (sf)	CN	Description
5,312	98	Paved parking, HSG A
4,523	39	>75% Grass cover, Good, HSG A
9,835	71	Weighted Average
4,523		45.99% Pervious Area
5,312		54.01% Impervious Area

Tc (min)	Length (feet)	Slope (ft/ft)	Velocity (ft/sec)	Capacity (cfs)	Description
5.0					Direct Entry,

Summary for Pond 1a: CB7

[57] Hint: Peaked at 21.54' (Flood elevation advised)

Inflow Area = 20,120 sf, 64.85% Impervious, Inflow Depth = 1.58" for 2-yr event
Inflow = 0.88 cfs @ 12.08 hrs, Volume= 2,650 cf
Outflow = 0.88 cfs @ 12.08 hrs, Volume= 2,650 cf, Atten= 0%, Lag= 0.0 min
Primary = 0.88 cfs @ 12.08 hrs, Volume= 2,650 cf
Routed to Pond 1b : CB2

Proposed Conditions 2023-09-19

Type III 24-hr 2-yr Rainfall=3.70"

Prepared by Haley Ward

Printed 11/17/2023

HydroCAD® 10.20-3g s/n 00801 © 2023 HydroCAD Software Solutions LLC

Page 14

Routing by Stor-Ind method, Time Span= 0.00-48.00 hrs, dt= 0.01 hrs
Peak Elev= 21.54' @ 12.08 hrs

Device	Routing	Invert	Outlet Devices
#1	Primary	21.06'	12.0" Round CMP_Round 12" L= 183.0' CMP, square edge headwall, Ke= 0.500 Inlet / Outlet Invert= 21.06' / 18.00' S= 0.0167 1' Cc= 0.900 n= 0.013 Concrete pipe, bends & connections, Flow Area= 0.79 sf

Primary OutFlow Max=0.88 cfs @ 12.08 hrs HW=21.54' (Free Discharge)
↑1=CMP_Round 12" (Inlet Controls 0.88 cfs @ 2.36 fps)

Summary for Pond 1b: CB2

[57] Hint: Peaked at 19.19' (Flood elevation advised)
[79] Warning: Submerged Pond 1a Primary device # 1 OUTLET by 1.19'

Inflow Area = 46,293 sf, 80.48% Impervious, Inflow Depth = 2.40" for 2-yr event
Inflow = 2.97 cfs @ 12.07 hrs, Volume= 9,261 cf
Outflow = 2.97 cfs @ 12.07 hrs, Volume= 9,261 cf, Atten= 0%, Lag= 0.0 min
Primary = 2.97 cfs @ 12.07 hrs, Volume= 9,261 cf
Routed to Link DP1 : Drainage System #1

Routing by Stor-Ind method, Time Span= 0.00-48.00 hrs, dt= 0.01 hrs
Peak Elev= 19.19' @ 12.07 hrs

Device	Routing	Invert	Outlet Devices
#1	Primary	17.95'	15.0" Round CMP_Round 15" L= 90.0' CMP, square edge headwall, Ke= 0.500 Inlet / Outlet Invert= 17.95' / 17.81' S= 0.0016 1' Cc= 0.900 n= 0.013 Concrete pipe, bends & connections, Flow Area= 1.23 sf

Primary OutFlow Max=2.97 cfs @ 12.07 hrs HW=19.19' (Free Discharge)
↑1=CMP_Round 15" (Barrel Controls 2.97 cfs @ 3.04 fps)

Summary for Pond 2a: CB6

[57] Hint: Peaked at 18.70' (Flood elevation advised)

Inflow Area = 88,068 sf, 44.32% Impervious, Inflow Depth = 0.82" for 2-yr event
Inflow = 0.97 cfs @ 12.44 hrs, Volume= 6,053 cf
Outflow = 0.97 cfs @ 12.44 hrs, Volume= 6,053 cf, Atten= 0%, Lag= 0.0 min
Primary = 0.97 cfs @ 12.44 hrs, Volume= 6,053 cf
Routed to Pond 2b : CB5

Routing by Stor-Ind method, Time Span= 0.00-48.00 hrs, dt= 0.01 hrs
Peak Elev= 18.70' @ 12.44 hrs

Device	Routing	Invert	Outlet Devices
#1	Primary	18.09'	18.0" Round Culvert

Proposed Conditions 2023-09-19

Type III 24-hr 2-yr Rainfall=3.70"

Prepared by Haley Ward

Printed 11/17/2023

HydroCAD® 10.20-3g s/n 00801 © 2023 HydroCAD Software Solutions LLC

Page 15

L= 58.0' CMP, square edge headwall, Ke= 0.500
Inlet / Outlet Invert= 18.09' / 18.02' S= 0.0012 '/ Cc= 0.900
n= 0.013 Concrete pipe, bends & connections, Flow Area= 1.77 sf

Primary OutFlow Max=0.97 cfs @ 12.44 hrs HW=18.70' (Free Discharge)
↑1=Culvert (Barrel Controls 0.97 cfs @ 2.11 fps)

Summary for Pond 2b: CB5

[57] Hint: Peaked at 18.81' (Flood elevation advised)
[81] Warning: Exceeded Pond 2a by 0.41' @ 12.06 hrs

Inflow Area = 104,728 sf, 51.59% Impervious, Inflow Depth = 1.14" for 2-yr event
Inflow = 1.52 cfs @ 12.08 hrs, Volume= 9,980 cf
Outflow = 1.52 cfs @ 12.08 hrs, Volume= 9,980 cf, Atten= 0%, Lag= 0.0 min
Primary = 1.52 cfs @ 12.08 hrs, Volume= 9,980 cf
Routed to Pond 2c : CB4

Routing by Stor-Ind method, Time Span= 0.00-48.00 hrs, dt= 0.01 hrs
Peak Elev= 18.81' @ 12.08 hrs

Device	Routing	Invert	Outlet Devices
#1	Primary	18.02'	18.0" Round Culvert L= 96.0' CMP, square edge headwall, Ke= 0.500 Inlet / Outlet Invert= 18.02' / 17.90' S= 0.0013 '/ Cc= 0.900 n= 0.013 Concrete pipe, bends & connections, Flow Area= 1.77 sf

Primary OutFlow Max=1.52 cfs @ 12.08 hrs HW=18.81' (Free Discharge)
↑1=Culvert (Barrel Controls 1.52 cfs @ 2.35 fps)

Summary for Pond 2c: CB4

[57] Hint: Peaked at 18.98' (Flood elevation advised)
[81] Warning: Exceeded Pond 2b by 0.18' @ 12.07 hrs

Inflow Area = 119,772 sf, 57.67% Impervious, Inflow Depth = 1.44" for 2-yr event
Inflow = 2.80 cfs @ 12.08 hrs, Volume= 14,325 cf
Outflow = 2.80 cfs @ 12.08 hrs, Volume= 14,325 cf, Atten= 0%, Lag= 0.0 min
Primary = 2.80 cfs @ 12.08 hrs, Volume= 14,325 cf
Routed to Pond 2d : CB3

Routing by Stor-Ind method, Time Span= 0.00-48.00 hrs, dt= 0.01 hrs
Peak Elev= 18.98' @ 12.08 hrs

Device	Routing	Invert	Outlet Devices
#1	Primary	17.90'	18.0" Round Culvert L= 81.0' CMP, square edge headwall, Ke= 0.500 Inlet / Outlet Invert= 17.90' / 17.80' S= 0.0012 '/ Cc= 0.900 n= 0.013 Concrete pipe, bends & connections, Flow Area= 1.77 sf

Primary OutFlow Max=2.80 cfs @ 12.08 hrs HW=18.98' (Free Discharge)
↑1=Culvert (Barrel Controls 2.80 cfs @ 2.87 fps)

Proposed Conditions 2023-09-19

Prepared by Haley Ward

HydroCAD® 10.20-3g s/n 00801 © 2023 HydroCAD Software Solutions LLC

Type III 24-hr 2-yr Rainfall=3.70"

Printed 11/17/2023

Page 16

Summary for Pond 2d: CB3

[57] Hint: Peaked at 18.83' (Flood elevation advised)

[79] Warning: Submerged Pond 2c Primary device # 1 INLET by 0.93'

Inflow Area = 128,179 sf, 60.44% Impervious, Inflow Depth = 1.57" for 2-yr event
 Inflow = 3.52 cfs @ 12.07 hrs, Volume= 16,753 cf
 Outflow = 3.52 cfs @ 12.07 hrs, Volume= 16,753 cf, Atten= 0%, Lag= 0.0 min
 Primary = 3.52 cfs @ 12.07 hrs, Volume= 16,753 cf
 Routed to Pond 2e : DMH 3

Routing by Stor-Ind method, Time Span= 0.00-48.00 hrs, dt= 0.01 hrs
 Peak Elev= 18.83' @ 12.07 hrs

Device	Routing	Invert	Outlet Devices
#1	Primary	17.70'	18.0" Round Culvert L= 7.0' CMP, square edge headwall, Ke= 0.500 Inlet / Outlet Invert= 17.70' / 17.69' S= 0.0014 '/ Cc= 0.900 n= 0.013 Concrete pipe, bends & connections, Flow Area= 1.77 sf

Primary OutFlow Max=3.52 cfs @ 12.07 hrs HW=18.83' (Free Discharge)

↑**1=Culvert** (Barrel Controls 3.52 cfs @ 3.41 fps)

Summary for Pond 2e: DMH 3

[57] Hint: Peaked at 18.50' (Flood elevation advised)

[79] Warning: Submerged Pond 2d Primary device # 1 INLET by 0.80'

Inflow Area = 128,179 sf, 60.44% Impervious, Inflow Depth = 1.57" for 2-yr event
 Inflow = 3.52 cfs @ 12.07 hrs, Volume= 16,753 cf
 Outflow = 3.52 cfs @ 12.07 hrs, Volume= 16,753 cf, Atten= 0%, Lag= 0.0 min
 Primary = 3.52 cfs @ 12.07 hrs, Volume= 16,753 cf
 Routed to Pond 2f : Jellyfish

Routing by Stor-Ind method, Time Span= 0.00-48.00 hrs, dt= 0.01 hrs
 Peak Elev= 18.50' @ 12.07 hrs

Device	Routing	Invert	Outlet Devices
#1	Primary	17.44'	24.0" Round Culvert L= 36.0' CMP, square edge headwall, Ke= 0.500 Inlet / Outlet Invert= 17.44' / 17.41' S= 0.0008 '/ Cc= 0.900 n= 0.013 Concrete pipe, bends & connections, Flow Area= 3.14 sf

Primary OutFlow Max=3.52 cfs @ 12.07 hrs HW=18.50' (Free Discharge)

↑**1=Culvert** (Barrel Controls 3.52 cfs @ 3.03 fps)

Proposed Conditions 2023-09-19

Prepared by Haley Ward

HydroCAD® 10.20-3g s/n 00801 © 2023 HydroCAD Software Solutions LLC

Type III 24-hr 2-yr Rainfall=3.70"

Printed 11/17/2023

Page 17

Summary for Pond 2f: Jellyfish

[57] Hint: Peaked at 18.35' (Flood elevation advised)

[79] Warning: Submerged Pond 2e Primary device # 1 INLET by 0.91'

Inflow Area = 128,179 sf, 60.44% Impervious, Inflow Depth = 1.57" for 2-yr event
Inflow = 3.52 cfs @ 12.07 hrs, Volume= 16,753 cf
Outflow = 3.52 cfs @ 12.07 hrs, Volume= 16,753 cf, Atten= 0%, Lag= 0.0 min
Primary = 3.52 cfs @ 12.07 hrs, Volume= 16,753 cf
Routed to Link DP2 : Drainage System #2 (CB1)

Routing by Stor-Ind method, Time Span= 0.00-48.00 hrs, dt= 0.01 hrs
Peak Elev= 18.35' @ 12.07 hrs

Device	Routing	Invert	Outlet Devices
#1	Primary	17.31'	24.0" Round Culvert L= 22.0' CMP, square edge headwall, Ke= 0.500 Inlet / Outlet Invert= 17.31' / 17.29' S= 0.0009 1' Cc= 0.900 n= 0.013 Concrete pipe, bends & connections, Flow Area= 3.14 sf

Primary OutFlow Max=3.52 cfs @ 12.07 hrs HW=18.35' (Free Discharge)

↑**1=Culvert** (Barrel Controls 3.52 cfs @ 3.12 fps)

Summary for Link DP1: Drainage System #1

Inflow Area = 50,887 sf, 82.21% Impervious, Inflow Depth = 2.50" for 2-yr event
Inflow = 3.37 cfs @ 12.07 hrs, Volume= 10,588 cf
Primary = 3.37 cfs @ 12.07 hrs, Volume= 10,588 cf, Atten= 0%, Lag= 0.0 min
Routed to nonexistent node 2R

Primary outflow = Inflow, Time Span= 0.00-48.00 hrs, dt= 0.01 hrs

Summary for Link DP2: Drainage System #2 (CB1)

Inflow Area = 138,014 sf, 59.98% Impervious, Inflow Depth = 1.54" for 2-yr event
Inflow = 3.83 cfs @ 12.07 hrs, Volume= 17,731 cf
Primary = 3.83 cfs @ 12.07 hrs, Volume= 17,731 cf, Atten= 0%, Lag= 0.0 min
Routed to nonexistent node 2R

Primary outflow = Inflow, Time Span= 0.00-48.00 hrs, dt= 0.01 hrs

Proposed Conditions 2023-09-19

Prepared by Haley Ward

HydroCAD® 10.20-3g s/n 00801 © 2023 HydroCAD Software Solutions LLC

Type III 24-hr 10-yr Rainfall=5.62"

Printed 11/17/2023

Page 18

Time span=0.00-48.00 hrs, dt=0.01 hrs, 4801 points
 Runoff by SCS TR-20 method, UH=SCS, Weighted-CN
 Reach routing by Stor-Ind+Trans method - Pond routing by Stor-Ind method

Subcatchment O1: Off-Site	Runoff Area=79,768 sf 45.80% Impervious Runoff Depth=2.08" Flow Length=584' Tc=27.6 min CN=65 Runoff=2.53 cfs 13,820 cf
Subcatchment P1a: PS1a	Runoff Area=20,120 sf 64.85% Impervious Runoff Depth=3.15" Tc=5.0 min CN=77 Runoff=1.77 cfs 5,281 cf
Subcatchment P1b: PS1b	Runoff Area=26,173 sf 92.50% Impervious Runoff Depth=4.92" Tc=5.0 min CN=94 Runoff=3.31 cfs 10,732 cf
Subcatchment P1c: PS1c	Runoff Area=4,594 sf 99.65% Impervious Runoff Depth=5.38" Tc=5.0 min CN=98 Runoff=0.60 cfs 2,061 cf
Subcatchment P2a: PS2a	Runoff Area=8,300 sf 30.05% Impervious Runoff Depth=1.45" Tc=5.0 min CN=57 Runoff=0.30 cfs 1,003 cf
Subcatchment P2b: PS2b	Runoff Area=16,660 sf 89.99% Impervious Runoff Depth=4.70" Tc=5.0 min CN=92 Runoff=2.05 cfs 6,520 cf
Subcatchment P2c: PS2c	Runoff Area=15,044 sf 100.00% Impervious Runoff Depth=5.38" Tc=5.0 min CN=98 Runoff=1.97 cfs 6,748 cf
Subcatchment P2d: PS2d	Runoff Area=8,407 sf 100.00% Impervious Runoff Depth=5.38" Tc=5.0 min CN=98 Runoff=1.10 cfs 3,771 cf
Subcatchment P3: PS3	Runoff Area=9,835 sf 54.01% Impervious Runoff Depth=2.60" Tc=5.0 min CN=71 Runoff=0.71 cfs 2,127 cf
Pond 1a: CB7	Peak Elev=21.79' Inflow=1.77 cfs 5,281 cf 12.0" Round Culvert n=0.013 L=183.0' S=0.0167 '/' Outflow=1.77 cfs 5,281 cf
Pond 1b: CB2	Peak Elev=20.02' Inflow=5.08 cfs 16,013 cf 15.0" Round Culvert n=0.013 L=90.0' S=0.0016 '/' Outflow=5.08 cfs 16,013 cf
Pond 2a: CB6	Peak Elev=19.12' Inflow=2.65 cfs 14,823 cf 18.0" Round Culvert n=0.013 L=58.0' S=0.0012 '/' Outflow=2.65 cfs 14,823 cf
Pond 2b: CB5	Peak Elev=19.21' Inflow=3.27 cfs 21,343 cf 18.0" Round Culvert n=0.013 L=96.0' S=0.0013 '/' Outflow=3.27 cfs 21,343 cf
Pond 2c: CB4	Peak Elev=19.47' Inflow=5.16 cfs 28,090 cf 18.0" Round Culvert n=0.013 L=81.0' S=0.0012 '/' Outflow=5.16 cfs 28,090 cf
Pond 2d: CB3	Peak Elev=19.32' Inflow=6.25 cfs 31,861 cf 18.0" Round Culvert n=0.013 L=7.0' S=0.0014 '/' Outflow=6.25 cfs 31,861 cf
Pond 2e: DMH 3	Peak Elev=18.88' Inflow=6.25 cfs 31,861 cf 24.0" Round Culvert n=0.013 L=36.0' S=0.0008 '/' Outflow=6.25 cfs 31,861 cf

Proposed Conditions 2023-09-19

Prepared by Haley Ward

HydroCAD® 10.20-3g s/n 00801 © 2023 HydroCAD Software Solutions LLC

Type III 24-hr 10-yr Rainfall=5.62"

Printed 11/17/2023

Page 19

Pond 2f: Jellyfish

Peak Elev=18.72' Inflow=6.25 cfs 31,861 cf
24.0" Round Culvert n=0.013 L=22.0' S=0.0009 '/ Outflow=6.25 cfs 31,861 cf

Link DP1: Drainage System #1

Inflow=5.68 cfs 18,073 cf
Primary=5.68 cfs 18,073 cf

Link DP2: Drainage System #2 (CB1)

Inflow=6.96 cfs 33,989 cf
Primary=6.96 cfs 33,989 cf

Total Runoff Area = 188,901 sf Runoff Volume = 52,062 cf Average Runoff Depth = 3.31"
34.03% Pervious = 64,280 sf 65.97% Impervious = 124,621 sf

Proposed Conditions 2023-09-19

Prepared by Haley Ward

HydroCAD® 10.20-3g s/n 00801 © 2023 HydroCAD Software Solutions LLC

Type III 24-hr 10-yr Rainfall=5.62"

Printed 11/17/2023

Page 20

Summary for Subcatchment O1: Off-Site

[47] Hint: Peak is 116% of capacity of segment #3

Runoff = 2.53 cfs @ 12.42 hrs, Volume= 13,820 cf, Depth= 2.08"
 Routed to Pond 2a : CB6

Runoff by SCS TR-20 method, UH=SCS, Weighted-CN, Time Span= 0.00-48.00 hrs, dt= 0.01 hrs
 Type III 24-hr 10-yr Rainfall=5.62"

Area (sf)	CN	Description
2,453	98	Unconnected roofs, HSG A
34,084	98	Paved parking, HSG A
22,052	36	Woods, Fair, HSG A
21,179	39	>75% Grass cover, Good, HSG A
79,768	65	Weighted Average
43,231		54.20% Pervious Area
36,537		45.80% Impervious Area
2,453		6.71% Unconnected

Tc (min)	Length (feet)	Slope (ft/ft)	Velocity (ft/sec)	Capacity (cfs)	Description
19.6	100	0.0250	0.08		Sheet Flow, Woods: Light underbrush n= 0.400 P2= 3.20"
7.3	374	0.0150	0.86		Shallow Concentrated Flow, Short Grass Pasture Kv= 7.0 fps
0.7	110	0.0050	2.78	2.18	Pipe Channel, RCP_Round 12" 12.0" Round Area= 0.8 sf Perim= 3.1' r= 0.25' n= 0.015 Concrete sewer w/manholes & inlets
27.6	584	Total			

Summary for Subcatchment P1a: PS1a

Runoff = 1.77 cfs @ 12.07 hrs, Volume= 5,281 cf, Depth= 3.15"
 Routed to Pond 1a : CB7

Runoff by SCS TR-20 method, UH=SCS, Weighted-CN, Time Span= 0.00-48.00 hrs, dt= 0.01 hrs
 Type III 24-hr 10-yr Rainfall=5.62"

Area (sf)	CN	Description
8,481	98	Paved parking, HSG A
4,566	98	Roofs, HSG A
7,073	39	>75% Grass cover, Good, HSG A
20,120	77	Weighted Average
7,073		35.15% Pervious Area
13,047		64.85% Impervious Area

Proposed Conditions 2023-09-19

Prepared by Haley Ward

HydroCAD® 10.20-3g s/n 00801 © 2023 HydroCAD Software Solutions LLC

Type III 24-hr 10-yr Rainfall=5.62"

Printed 11/17/2023

Page 21

Tc (min)	Length (feet)	Slope (ft/ft)	Velocity (ft/sec)	Capacity (cfs)	Description
5.0					Direct Entry,

Summary for Subcatchment P1b: PS1b

Runoff = 3.31 cfs @ 12.07 hrs, Volume= 10,732 cf, Depth= 4.92"
Routed to Pond 1b : CB2

Runoff by SCS TR-20 method, UH=SCS, Weighted-CN, Time Span= 0.00-48.00 hrs, dt= 0.01 hrs
Type III 24-hr 10-yr Rainfall=5.62"

Area (sf)	CN	Description
10,744	98	Paved parking, HSG A
13,465	98	Roofs, HSG A
1,964	39	>75% Grass cover, Good, HSG A
26,173	94	Weighted Average
1,964		7.50% Pervious Area
24,209		92.50% Impervious Area

Tc (min)	Length (feet)	Slope (ft/ft)	Velocity (ft/sec)	Capacity (cfs)	Description
5.0					Direct Entry,

Summary for Subcatchment P1c: PS1c

Runoff = 0.60 cfs @ 12.07 hrs, Volume= 2,061 cf, Depth= 5.38"
Routed to Link DP1 : Drainage System #1

Runoff by SCS TR-20 method, UH=SCS, Weighted-CN, Time Span= 0.00-48.00 hrs, dt= 0.01 hrs
Type III 24-hr 10-yr Rainfall=5.62"

Area (sf)	CN	Description
4,578	98	Paved parking, HSG A
16	39	>75% Grass cover, Good, HSG A
4,594	98	Weighted Average
16		0.35% Pervious Area
4,578		99.65% Impervious Area

Tc (min)	Length (feet)	Slope (ft/ft)	Velocity (ft/sec)	Capacity (cfs)	Description
5.0					Direct Entry,

Summary for Subcatchment P2a: PS2a

Runoff = 0.30 cfs @ 12.09 hrs, Volume= 1,003 cf, Depth= 1.45"
Routed to Pond 2a : CB6

Runoff by SCS TR-20 method, UH=SCS, Weighted-CN, Time Span= 0.00-48.00 hrs, dt= 0.01 hrs
Type III 24-hr 10-yr Rainfall=5.62"

Proposed Conditions 2023-09-19

Prepared by Haley Ward

HydroCAD® 10.20-3g s/n 00801 © 2023 HydroCAD Software Solutions LLC

Type III 24-hr 10-yr Rainfall=5.62"

Printed 11/17/2023

Page 22

Area (sf)	CN	Description
2,465	98	Paved parking, HSG A
29	98	Roofs, HSG A
5,806	39	>75% Grass cover, Good, HSG A
8,300	57	Weighted Average
5,806		69.95% Pervious Area
2,494		30.05% Impervious Area

Tc (min)	Length (feet)	Slope (ft/ft)	Velocity (ft/sec)	Capacity (cfs)	Description
5.0					Direct Entry,

Summary for Subcatchment P2b: PS2b

Runoff = 2.05 cfs @ 12.07 hrs, Volume= 6,520 cf, Depth= 4.70"
Routed to Pond 2b : CB5

Runoff by SCS TR-20 method, UH=SCS, Weighted-CN, Time Span= 0.00-48.00 hrs, dt= 0.01 hrs
Type III 24-hr 10-yr Rainfall=5.62"

Area (sf)	CN	Description
6,157	98	Paved parking, HSG A
8,836	98	Roofs, HSG A
1,667	39	>75% Grass cover, Good, HSG A
16,660	92	Weighted Average
1,667		10.01% Pervious Area
14,993		89.99% Impervious Area

Tc (min)	Length (feet)	Slope (ft/ft)	Velocity (ft/sec)	Capacity (cfs)	Description
5.0					Direct Entry,

Summary for Subcatchment P2c: PS2c

Runoff = 1.97 cfs @ 12.07 hrs, Volume= 6,748 cf, Depth= 5.38"
Routed to Pond 2c : CB4

Runoff by SCS TR-20 method, UH=SCS, Weighted-CN, Time Span= 0.00-48.00 hrs, dt= 0.01 hrs
Type III 24-hr 10-yr Rainfall=5.62"

Area (sf)	CN	Description
3,896	98	Paved parking, HSG A
11,148	98	Roofs, HSG A
15,044	98	Weighted Average
15,044		100.00% Impervious Area

Proposed Conditions 2023-09-19

Prepared by Haley Ward

HydroCAD® 10.20-3g s/n 00801 © 2023 HydroCAD Software Solutions LLC

Type III 24-hr 10-yr Rainfall=5.62"

Printed 11/17/2023

Page 23

Tc (min)	Length (feet)	Slope (ft/ft)	Velocity (ft/sec)	Capacity (cfs)	Description
5.0					Direct Entry,

Summary for Subcatchment P2d: PS2d

Runoff = 1.10 cfs @ 12.07 hrs, Volume= 3,771 cf, Depth= 5.38"
Routed to Pond 2d : CB3

Runoff by SCS TR-20 method, UH=SCS, Weighted-CN, Time Span= 0.00-48.00 hrs, dt= 0.01 hrs
Type III 24-hr 10-yr Rainfall=5.62"

Area (sf)	CN	Description
2,897	98	Paved parking, HSG A
5,510	98	Roofs, HSG A
8,407	98	Weighted Average
8,407		100.00% Impervious Area

Tc (min)	Length (feet)	Slope (ft/ft)	Velocity (ft/sec)	Capacity (cfs)	Description
5.0					Direct Entry,

Summary for Subcatchment P3: PS3

Runoff = 0.71 cfs @ 12.08 hrs, Volume= 2,127 cf, Depth= 2.60"
Routed to Link DP2 : Drainage System #2 (CB1)

Runoff by SCS TR-20 method, UH=SCS, Weighted-CN, Time Span= 0.00-48.00 hrs, dt= 0.01 hrs
Type III 24-hr 10-yr Rainfall=5.62"

Area (sf)	CN	Description
5,312	98	Paved parking, HSG A
4,523	39	>75% Grass cover, Good, HSG A
9,835	71	Weighted Average
4,523		45.99% Pervious Area
5,312		54.01% Impervious Area

Tc (min)	Length (feet)	Slope (ft/ft)	Velocity (ft/sec)	Capacity (cfs)	Description
5.0					Direct Entry,

Summary for Pond 1a: CB7

[57] Hint: Peaked at 21.79' (Flood elevation advised)

Inflow Area = 20,120 sf, 64.85% Impervious, Inflow Depth = 3.15" for 10-yr event
Inflow = 1.77 cfs @ 12.07 hrs, Volume= 5,281 cf
Outflow = 1.77 cfs @ 12.07 hrs, Volume= 5,281 cf, Atten= 0%, Lag= 0.0 min
Primary = 1.77 cfs @ 12.07 hrs, Volume= 5,281 cf
Routed to Pond 1b : CB2

Proposed Conditions 2023-09-19

Prepared by Haley Ward

HydroCAD® 10.20-3g s/n 00801 © 2023 HydroCAD Software Solutions LLC

Type III 24-hr 10-yr Rainfall=5.62"

Printed 11/17/2023

Page 24

Routing by Stor-Ind method, Time Span= 0.00-48.00 hrs, dt= 0.01 hrs

Peak Elev= 21.79' @ 12.07 hrs

Device	Routing	Invert	Outlet Devices
#1	Primary	21.06'	12.0" Round CMP_Round 12" L= 183.0' CMP, square edge headwall, Ke= 0.500 Inlet / Outlet Invert= 21.06' / 18.00' S= 0.0167 '/ Cc= 0.900 n= 0.013 Concrete pipe, bends & connections, Flow Area= 0.79 sf

Primary OutFlow Max=1.76 cfs @ 12.07 hrs HW=21.78' (Free Discharge)

↑1=CMP_Round 12" (Inlet Controls 1.76 cfs @ 2.90 fps)

Summary for Pond 1b: CB2

[57] Hint: Peaked at 20.02' (Flood elevation advised)

[79] Warning: Submerged Pond 1a Primary device # 1 OUTLET by 2.02'

Inflow Area = 46,293 sf, 80.48% Impervious, Inflow Depth = 4.15" for 10-yr event
 Inflow = 5.08 cfs @ 12.07 hrs, Volume= 16,013 cf
 Outflow = 5.08 cfs @ 12.07 hrs, Volume= 16,013 cf, Atten= 0%, Lag= 0.0 min
 Primary = 5.08 cfs @ 12.07 hrs, Volume= 16,013 cf
 Routed to Link DP1 : Drainage System #1

Routing by Stor-Ind method, Time Span= 0.00-48.00 hrs, dt= 0.01 hrs

Peak Elev= 20.02' @ 12.07 hrs

Device	Routing	Invert	Outlet Devices
#1	Primary	17.95'	15.0" Round CMP_Round 15" L= 90.0' CMP, square edge headwall, Ke= 0.500 Inlet / Outlet Invert= 17.95' / 17.81' S= 0.0016 '/ Cc= 0.900 n= 0.013 Concrete pipe, bends & connections, Flow Area= 1.23 sf

Primary OutFlow Max=5.07 cfs @ 12.07 hrs HW=20.01' (Free Discharge)

↑1=CMP_Round 15" (Barrel Controls 5.07 cfs @ 4.13 fps)

Summary for Pond 2a: CB6

[57] Hint: Peaked at 19.12' (Flood elevation advised)

Inflow Area = 88,068 sf, 44.32% Impervious, Inflow Depth = 2.02" for 10-yr event
 Inflow = 2.65 cfs @ 12.40 hrs, Volume= 14,823 cf
 Outflow = 2.65 cfs @ 12.40 hrs, Volume= 14,823 cf, Atten= 0%, Lag= 0.0 min
 Primary = 2.65 cfs @ 12.40 hrs, Volume= 14,823 cf
 Routed to Pond 2b : CB5

Routing by Stor-Ind method, Time Span= 0.00-48.00 hrs, dt= 0.01 hrs

Peak Elev= 19.12' @ 12.40 hrs

Device	Routing	Invert	Outlet Devices
#1	Primary	18.09'	18.0" Round Culvert

Proposed Conditions 2023-09-19

Type III 24-hr 10-yr Rainfall=5.62"

Prepared by Haley Ward

Printed 11/17/2023

HydroCAD® 10.20-3g s/n 00801 © 2023 HydroCAD Software Solutions LLC

Page 25

L= 58.0' CMP, square edge headwall, Ke= 0.500
Inlet / Outlet Invert= 18.09' / 18.02' S= 0.0012 '/ Cc= 0.900
n= 0.013 Concrete pipe, bends & connections, Flow Area= 1.77 sf

Primary OutFlow Max=2.65 cfs @ 12.40 hrs HW=19.12' (Free Discharge)
↑1=Culvert (Barrel Controls 2.65 cfs @ 2.88 fps)

Summary for Pond 2b: CB5

[57] Hint: Peaked at 19.21' (Flood elevation advised)
[81] Warning: Exceeded Pond 2a by 0.44' @ 12.06 hrs

Inflow Area = 104,728 sf, 51.59% Impervious, Inflow Depth = 2.45" for 10-yr event
Inflow = 3.27 cfs @ 12.36 hrs, Volume= 21,343 cf
Outflow = 3.27 cfs @ 12.36 hrs, Volume= 21,343 cf, Atten= 0%, Lag= 0.0 min
Primary = 3.27 cfs @ 12.36 hrs, Volume= 21,343 cf
Routed to Pond 2c : CB4

Routing by Stor-Ind method, Time Span= 0.00-48.00 hrs, dt= 0.01 hrs
Peak Elev= 19.21' @ 12.36 hrs

Device	Routing	Invert	Outlet Devices
#1	Primary	18.02'	18.0" Round Culvert L= 96.0' CMP, square edge headwall, Ke= 0.500 Inlet / Outlet Invert= 18.02' / 17.90' S= 0.0013 '/ Cc= 0.900 n= 0.013 Concrete pipe, bends & connections, Flow Area= 1.77 sf

Primary OutFlow Max=3.27 cfs @ 12.36 hrs HW=19.21' (Free Discharge)
↑1=Culvert (Barrel Controls 3.27 cfs @ 2.98 fps)

Summary for Pond 2c: CB4

[57] Hint: Peaked at 19.47' (Flood elevation advised)
[81] Warning: Exceeded Pond 2b by 0.28' @ 12.07 hrs

Inflow Area = 119,772 sf, 57.67% Impervious, Inflow Depth = 2.81" for 10-yr event
Inflow = 5.16 cfs @ 12.08 hrs, Volume= 28,090 cf
Outflow = 5.16 cfs @ 12.08 hrs, Volume= 28,090 cf, Atten= 0%, Lag= 0.0 min
Primary = 5.16 cfs @ 12.08 hrs, Volume= 28,090 cf
Routed to Pond 2d : CB3

Routing by Stor-Ind method, Time Span= 0.00-48.00 hrs, dt= 0.01 hrs
Peak Elev= 19.47' @ 12.08 hrs

Device	Routing	Invert	Outlet Devices
#1	Primary	17.90'	18.0" Round Culvert L= 81.0' CMP, square edge headwall, Ke= 0.500 Inlet / Outlet Invert= 17.90' / 17.80' S= 0.0012 '/ Cc= 0.900 n= 0.013 Concrete pipe, bends & connections, Flow Area= 1.77 sf

Primary OutFlow Max=5.15 cfs @ 12.08 hrs HW=19.47' (Free Discharge)
↑1=Culvert (Barrel Controls 5.15 cfs @ 3.46 fps)

Proposed Conditions 2023-09-19

Prepared by Haley Ward

HydroCAD® 10.20-3g s/n 00801 © 2023 HydroCAD Software Solutions LLC

Type III 24-hr 10-yr Rainfall=5.62"

Printed 11/17/2023

Page 26

Summary for Pond 2d: CB3

[57] Hint: Peaked at 19.32' (Flood elevation advised)

[79] Warning: Submerged Pond 2c Primary device # 1 INLET by 1.42'

Inflow Area = 128,179 sf, 60.44% Impervious, Inflow Depth = 2.98" for 10-yr event
 Inflow = 6.25 cfs @ 12.08 hrs, Volume= 31,861 cf
 Outflow = 6.25 cfs @ 12.08 hrs, Volume= 31,861 cf, Atten= 0%, Lag= 0.0 min
 Primary = 6.25 cfs @ 12.08 hrs, Volume= 31,861 cf
 Routed to Pond 2e : DMH 3

Routing by Stor-Ind method, Time Span= 0.00-48.00 hrs, dt= 0.01 hrs
 Peak Elev= 19.32' @ 12.08 hrs

Device	Routing	Invert	Outlet Devices
#1	Primary	17.70'	18.0" Round Culvert L= 7.0' CMP, square edge headwall, Ke= 0.500 Inlet / Outlet Invert= 17.70' / 17.69' S= 0.0014 '/ Cc= 0.900 n= 0.013 Concrete pipe, bends & connections, Flow Area= 1.77 sf

Primary OutFlow Max=6.24 cfs @ 12.08 hrs HW=19.32' (Free Discharge)

↑**1=Culvert** (Barrel Controls 6.24 cfs @ 4.08 fps)

Summary for Pond 2e: DMH 3

[57] Hint: Peaked at 18.88' (Flood elevation advised)

[79] Warning: Submerged Pond 2d Primary device # 1 INLET by 1.18'

Inflow Area = 128,179 sf, 60.44% Impervious, Inflow Depth = 2.98" for 10-yr event
 Inflow = 6.25 cfs @ 12.08 hrs, Volume= 31,861 cf
 Outflow = 6.25 cfs @ 12.08 hrs, Volume= 31,861 cf, Atten= 0%, Lag= 0.0 min
 Primary = 6.25 cfs @ 12.08 hrs, Volume= 31,861 cf
 Routed to Pond 2f : Jellyfish

Routing by Stor-Ind method, Time Span= 0.00-48.00 hrs, dt= 0.01 hrs
 Peak Elev= 18.88' @ 12.08 hrs

Device	Routing	Invert	Outlet Devices
#1	Primary	17.44'	24.0" Round Culvert L= 36.0' CMP, square edge headwall, Ke= 0.500 Inlet / Outlet Invert= 17.44' / 17.41' S= 0.0008 '/ Cc= 0.900 n= 0.013 Concrete pipe, bends & connections, Flow Area= 3.14 sf

Primary OutFlow Max=6.24 cfs @ 12.08 hrs HW=18.88' (Free Discharge)

↑**1=Culvert** (Barrel Controls 6.24 cfs @ 3.61 fps)

Summary for Pond 2f: Jellyfish

[57] Hint: Peaked at 18.72' (Flood elevation advised)

[79] Warning: Submerged Pond 2e Primary device # 1 INLET by 1.28'

Inflow Area = 128,179 sf, 60.44% Impervious, Inflow Depth = 2.98" for 10-yr event
 Inflow = 6.25 cfs @ 12.08 hrs, Volume= 31,861 cf
 Outflow = 6.25 cfs @ 12.08 hrs, Volume= 31,861 cf, Atten= 0%, Lag= 0.0 min
 Primary = 6.25 cfs @ 12.08 hrs, Volume= 31,861 cf
 Routed to Link DP2 : Drainage System #2 (CB1)

Routing by Stor-Ind method, Time Span= 0.00-48.00 hrs, dt= 0.01 hrs
 Peak Elev= 18.72' @ 12.08 hrs

Device	Routing	Invert	Outlet Devices
#1	Primary	17.31'	24.0" Round Culvert L= 22.0' CMP, square edge headwall, Ke= 0.500 Inlet / Outlet Invert= 17.31' / 17.29' S= 0.0009 '/ Cc= 0.900 n= 0.013 Concrete pipe, bends & connections, Flow Area= 3.14 sf

Primary OutFlow Max=6.24 cfs @ 12.08 hrs HW=18.72' (Free Discharge)
 ↑**1=Culvert** (Barrel Controls 6.24 cfs @ 3.69 fps)

Summary for Link DP1: Drainage System #1

Inflow Area = 50,887 sf, 82.21% Impervious, Inflow Depth = 4.26" for 10-yr event
 Inflow = 5.68 cfs @ 12.07 hrs, Volume= 18,073 cf
 Primary = 5.68 cfs @ 12.07 hrs, Volume= 18,073 cf, Atten= 0%, Lag= 0.0 min
 Routed to nonexistent node 2R

Primary outflow = Inflow, Time Span= 0.00-48.00 hrs, dt= 0.01 hrs

Summary for Link DP2: Drainage System #2 (CB1)

Inflow Area = 138,014 sf, 59.98% Impervious, Inflow Depth = 2.96" for 10-yr event
 Inflow = 6.96 cfs @ 12.08 hrs, Volume= 33,989 cf
 Primary = 6.96 cfs @ 12.08 hrs, Volume= 33,989 cf, Atten= 0%, Lag= 0.0 min
 Routed to nonexistent node 2R

Primary outflow = Inflow, Time Span= 0.00-48.00 hrs, dt= 0.01 hrs

Proposed Conditions 2023-09-19

Prepared by Haley Ward

HydroCAD® 10.20-3g s/n 00801 © 2023 HydroCAD Software Solutions LLC

Type III 24-hr 25-yr Rainfall=7.13"

Printed 11/17/2023

Page 28

Time span=0.00-48.00 hrs, dt=0.01 hrs, 4801 points
 Runoff by SCS TR-20 method, UH=SCS, Weighted-CN
 Reach routing by Stor-Ind+Trans method - Pond routing by Stor-Ind method

Subcatchment O1: Off-Site	Runoff Area=79,768 sf 45.80% Impervious Runoff Depth=3.20" Flow Length=584' Tc=27.6 min CN=65 Runoff=3.99 cfs 21,294 cf
Subcatchment P1a: PS1a	Runoff Area=20,120 sf 64.85% Impervious Runoff Depth=4.48" Tc=5.0 min CN=77 Runoff=2.51 cfs 7,516 cf
Subcatchment P1b: PS1b	Runoff Area=26,173 sf 92.50% Impervious Runoff Depth=6.42" Tc=5.0 min CN=94 Runoff=4.26 cfs 13,997 cf
Subcatchment P1c: PS1c	Runoff Area=4,594 sf 99.65% Impervious Runoff Depth=6.89" Tc=5.0 min CN=98 Runoff=0.76 cfs 2,638 cf
Subcatchment P2a: PS2a	Runoff Area=8,300 sf 30.05% Impervious Runoff Depth=2.40" Tc=5.0 min CN=57 Runoff=0.53 cfs 1,660 cf
Subcatchment P2b: PS2b	Runoff Area=16,660 sf 89.99% Impervious Runoff Depth=6.18" Tc=5.0 min CN=92 Runoff=2.66 cfs 8,584 cf
Subcatchment P2c: PS2c	Runoff Area=15,044 sf 100.00% Impervious Runoff Depth=6.89" Tc=5.0 min CN=98 Runoff=2.50 cfs 8,639 cf
Subcatchment P2d: PS2d	Runoff Area=8,407 sf 100.00% Impervious Runoff Depth=6.89" Tc=5.0 min CN=98 Runoff=1.40 cfs 4,828 cf
Subcatchment P3: PS3	Runoff Area=9,835 sf 54.01% Impervious Runoff Depth=3.83" Tc=5.0 min CN=71 Runoff=1.05 cfs 3,142 cf
Pond 1a: CB7	Peak Elev=21.99' Inflow=2.51 cfs 7,516 cf 12.0" Round Culvert n=0.013 L=183.0' S=0.0167 '/' Outflow=2.51 cfs 7,516 cf
Pond 1b: CB2	Peak Elev=20.76' Inflow=6.76 cfs 21,513 cf 15.0" Round Culvert n=0.013 L=90.0' S=0.0016 '/' Outflow=6.76 cfs 21,513 cf
Pond 2a: CB6	Peak Elev=19.43' Inflow=4.19 cfs 22,954 cf 18.0" Round Culvert n=0.013 L=58.0' S=0.0012 '/' Outflow=4.19 cfs 22,954 cf
Pond 2b: CB5	Peak Elev=19.58' Inflow=5.00 cfs 31,539 cf 18.0" Round Culvert n=0.013 L=96.0' S=0.0013 '/' Outflow=5.00 cfs 31,539 cf
Pond 2c: CB4	Peak Elev=20.06' Inflow=7.18 cfs 40,177 cf 18.0" Round Culvert n=0.013 L=81.0' S=0.0012 '/' Outflow=7.18 cfs 40,177 cf
Pond 2d: CB3	Peak Elev=19.78' Inflow=8.57 cfs 45,005 cf 18.0" Round Culvert n=0.013 L=7.0' S=0.0014 '/' Outflow=8.57 cfs 45,005 cf
Pond 2e: DMH 3	Peak Elev=19.17' Inflow=8.57 cfs 45,005 cf 24.0" Round Culvert n=0.013 L=36.0' S=0.0008 '/' Outflow=8.57 cfs 45,005 cf

Proposed Conditions 2023-09-19

Prepared by Haley Ward

HydroCAD® 10.20-3g s/n 00801 © 2023 HydroCAD Software Solutions LLC

Type III 24-hr 25-yr Rainfall=7.13"

Printed 11/17/2023

Page 29

Pond 2f: Jellyfish

Peak Elev=19.01' Inflow=8.57 cfs 45,005 cf
24.0" Round Culvert n=0.013 L=22.0' S=0.0009 '/ Outflow=8.57 cfs 45,005 cf

Link DP1: Drainage System #1

Inflow=7.53 cfs 24,151 cf
Primary=7.53 cfs 24,151 cf

Link DP2: Drainage System #2 (CB1)

Inflow=9.62 cfs 48,147 cf
Primary=9.62 cfs 48,147 cf

Total Runoff Area = 188,901 sf Runoff Volume = 72,298 cf Average Runoff Depth = 4.59"
34.03% Pervious = 64,280 sf 65.97% Impervious = 124,621 sf

Proposed Conditions 2023-09-19

Prepared by Haley Ward

HydroCAD® 10.20-3g s/n 00801 © 2023 HydroCAD Software Solutions LLC

Type III 24-hr 25-yr Rainfall=7.13"

Printed 11/17/2023

Page 30

Summary for Subcatchment O1: Off-Site

[47] Hint: Peak is 183% of capacity of segment #3

Runoff = 3.99 cfs @ 12.39 hrs, Volume= 21,294 cf, Depth= 3.20"
Routed to Pond 2a : CB6

Runoff by SCS TR-20 method, UH=SCS, Weighted-CN, Time Span= 0.00-48.00 hrs, dt= 0.01 hrs
Type III 24-hr 25-yr Rainfall=7.13"

Area (sf)	CN	Description
2,453	98	Unconnected roofs, HSG A
34,084	98	Paved parking, HSG A
22,052	36	Woods, Fair, HSG A
21,179	39	>75% Grass cover, Good, HSG A
79,768	65	Weighted Average
43,231		54.20% Pervious Area
36,537		45.80% Impervious Area
2,453		6.71% Unconnected

Tc (min)	Length (feet)	Slope (ft/ft)	Velocity (ft/sec)	Capacity (cfs)	Description
19.6	100	0.0250	0.08		Sheet Flow, Woods: Light underbrush n= 0.400 P2= 3.20"
7.3	374	0.0150	0.86		Shallow Concentrated Flow, Short Grass Pasture Kv= 7.0 fps
0.7	110	0.0050	2.78	2.18	Pipe Channel, RCP_Round 12" 12.0" Round Area= 0.8 sf Perim= 3.1' r= 0.25' n= 0.015 Concrete sewer w/manholes & inlets
27.6	584	Total			

Summary for Subcatchment P1a: PS1a

Runoff = 2.51 cfs @ 12.07 hrs, Volume= 7,516 cf, Depth= 4.48"
Routed to Pond 1a : CB7

Runoff by SCS TR-20 method, UH=SCS, Weighted-CN, Time Span= 0.00-48.00 hrs, dt= 0.01 hrs
Type III 24-hr 25-yr Rainfall=7.13"

Area (sf)	CN	Description
8,481	98	Paved parking, HSG A
4,566	98	Roofs, HSG A
7,073	39	>75% Grass cover, Good, HSG A
20,120	77	Weighted Average
7,073		35.15% Pervious Area
13,047		64.85% Impervious Area

Proposed Conditions 2023-09-19

Prepared by Haley Ward

HydroCAD® 10.20-3g s/n 00801 © 2023 HydroCAD Software Solutions LLC

Type III 24-hr 25-yr Rainfall=7.13"

Printed 11/17/2023

Page 31

Tc (min)	Length (feet)	Slope (ft/ft)	Velocity (ft/sec)	Capacity (cfs)	Description
5.0					Direct Entry,

Summary for Subcatchment P1b: PS1b

Runoff = 4.26 cfs @ 12.07 hrs, Volume= 13,997 cf, Depth= 6.42"
Routed to Pond 1b : CB2

Runoff by SCS TR-20 method, UH=SCS, Weighted-CN, Time Span= 0.00-48.00 hrs, dt= 0.01 hrs
Type III 24-hr 25-yr Rainfall=7.13"

Area (sf)	CN	Description
10,744	98	Paved parking, HSG A
13,465	98	Roofs, HSG A
1,964	39	>75% Grass cover, Good, HSG A
26,173	94	Weighted Average
1,964		7.50% Pervious Area
24,209		92.50% Impervious Area

Tc (min)	Length (feet)	Slope (ft/ft)	Velocity (ft/sec)	Capacity (cfs)	Description
5.0					Direct Entry,

Summary for Subcatchment P1c: PS1c

Runoff = 0.76 cfs @ 12.07 hrs, Volume= 2,638 cf, Depth= 6.89"
Routed to Link DP1 : Drainage System #1

Runoff by SCS TR-20 method, UH=SCS, Weighted-CN, Time Span= 0.00-48.00 hrs, dt= 0.01 hrs
Type III 24-hr 25-yr Rainfall=7.13"

Area (sf)	CN	Description
4,578	98	Paved parking, HSG A
16	39	>75% Grass cover, Good, HSG A
4,594	98	Weighted Average
16		0.35% Pervious Area
4,578		99.65% Impervious Area

Tc (min)	Length (feet)	Slope (ft/ft)	Velocity (ft/sec)	Capacity (cfs)	Description
5.0					Direct Entry,

Summary for Subcatchment P2a: PS2a

Runoff = 0.53 cfs @ 12.08 hrs, Volume= 1,660 cf, Depth= 2.40"
Routed to Pond 2a : CB6

Runoff by SCS TR-20 method, UH=SCS, Weighted-CN, Time Span= 0.00-48.00 hrs, dt= 0.01 hrs
Type III 24-hr 25-yr Rainfall=7.13"

Proposed Conditions 2023-09-19

Prepared by Haley Ward

HydroCAD® 10.20-3g s/n 00801 © 2023 HydroCAD Software Solutions LLC

Type III 24-hr 25-yr Rainfall=7.13"

Printed 11/17/2023

Page 32

Area (sf)	CN	Description
2,465	98	Paved parking, HSG A
29	98	Roofs, HSG A
5,806	39	>75% Grass cover, Good, HSG A
8,300	57	Weighted Average
5,806		69.95% Pervious Area
2,494		30.05% Impervious Area

Tc (min)	Length (feet)	Slope (ft/ft)	Velocity (ft/sec)	Capacity (cfs)	Description
5.0					Direct Entry,

Summary for Subcatchment P2b: PS2b

Runoff = 2.66 cfs @ 12.07 hrs, Volume= 8,584 cf, Depth= 6.18"
Routed to Pond 2b : CB5

Runoff by SCS TR-20 method, UH=SCS, Weighted-CN, Time Span= 0.00-48.00 hrs, dt= 0.01 hrs
Type III 24-hr 25-yr Rainfall=7.13"

Area (sf)	CN	Description
6,157	98	Paved parking, HSG A
8,836	98	Roofs, HSG A
1,667	39	>75% Grass cover, Good, HSG A
16,660	92	Weighted Average
1,667		10.01% Pervious Area
14,993		89.99% Impervious Area

Tc (min)	Length (feet)	Slope (ft/ft)	Velocity (ft/sec)	Capacity (cfs)	Description
5.0					Direct Entry,

Summary for Subcatchment P2c: PS2c

Runoff = 2.50 cfs @ 12.07 hrs, Volume= 8,639 cf, Depth= 6.89"
Routed to Pond 2c : CB4

Runoff by SCS TR-20 method, UH=SCS, Weighted-CN, Time Span= 0.00-48.00 hrs, dt= 0.01 hrs
Type III 24-hr 25-yr Rainfall=7.13"

Area (sf)	CN	Description
3,896	98	Paved parking, HSG A
11,148	98	Roofs, HSG A
15,044	98	Weighted Average
15,044		100.00% Impervious Area

Proposed Conditions 2023-09-19

Prepared by Haley Ward

HydroCAD® 10.20-3g s/n 00801 © 2023 HydroCAD Software Solutions LLC

Type III 24-hr 25-yr Rainfall=7.13"

Printed 11/17/2023

Page 33

Tc (min)	Length (feet)	Slope (ft/ft)	Velocity (ft/sec)	Capacity (cfs)	Description
5.0					Direct Entry,

Summary for Subcatchment P2d: PS2d

Runoff = 1.40 cfs @ 12.07 hrs, Volume= 4,828 cf, Depth= 6.89"
Routed to Pond 2d : CB3

Runoff by SCS TR-20 method, UH=SCS, Weighted-CN, Time Span= 0.00-48.00 hrs, dt= 0.01 hrs
Type III 24-hr 25-yr Rainfall=7.13"

Area (sf)	CN	Description
2,897	98	Paved parking, HSG A
5,510	98	Roofs, HSG A
8,407	98	Weighted Average
8,407		100.00% Impervious Area

Tc (min)	Length (feet)	Slope (ft/ft)	Velocity (ft/sec)	Capacity (cfs)	Description
5.0					Direct Entry,

Summary for Subcatchment P3: PS3

Runoff = 1.05 cfs @ 12.08 hrs, Volume= 3,142 cf, Depth= 3.83"
Routed to Link DP2 : Drainage System #2 (CB1)

Runoff by SCS TR-20 method, UH=SCS, Weighted-CN, Time Span= 0.00-48.00 hrs, dt= 0.01 hrs
Type III 24-hr 25-yr Rainfall=7.13"

Area (sf)	CN	Description
5,312	98	Paved parking, HSG A
4,523	39	>75% Grass cover, Good, HSG A
9,835	71	Weighted Average
4,523		45.99% Pervious Area
5,312		54.01% Impervious Area

Tc (min)	Length (feet)	Slope (ft/ft)	Velocity (ft/sec)	Capacity (cfs)	Description
5.0					Direct Entry,

Summary for Pond 1a: CB7

[57] Hint: Peaked at 21.99' (Flood elevation advised)

Inflow Area = 20,120 sf, 64.85% Impervious, Inflow Depth = 4.48" for 25-yr event
Inflow = 2.51 cfs @ 12.07 hrs, Volume= 7,516 cf
Outflow = 2.51 cfs @ 12.07 hrs, Volume= 7,516 cf, Atten= 0%, Lag= 0.0 min
Primary = 2.51 cfs @ 12.07 hrs, Volume= 7,516 cf
Routed to Pond 1b : CB2

Proposed Conditions 2023-09-19

Prepared by Haley Ward

HydroCAD® 10.20-3g s/n 00801 © 2023 HydroCAD Software Solutions LLC

Type III 24-hr 25-yr Rainfall=7.13"

Printed 11/17/2023

Page 34

Routing by Stor-Ind method, Time Span= 0.00-48.00 hrs, dt= 0.01 hrs

Peak Elev= 21.99' @ 12.07 hrs

Device	Routing	Invert	Outlet Devices
#1	Primary	21.06'	12.0" Round CMP_Round 12" L= 183.0' CMP, square edge headwall, Ke= 0.500 Inlet / Outlet Invert= 21.06' / 18.00' S= 0.0167 1' Cc= 0.900 n= 0.013 Concrete pipe, bends & connections, Flow Area= 0.79 sf

Primary OutFlow Max=2.50 cfs @ 12.07 hrs HW=21.99' (Free Discharge)

↑1=CMP_Round 12" (Inlet Controls 2.50 cfs @ 3.28 fps)

Summary for Pond 1b: CB2

[57] Hint: Peaked at 20.76' (Flood elevation advised)

[79] Warning: Submerged Pond 1a Primary device # 1 OUTLET by 2.76'

Inflow Area = 46,293 sf, 80.48% Impervious, Inflow Depth = 5.58" for 25-yr event
Inflow = 6.76 cfs @ 12.07 hrs, Volume= 21,513 cf
Outflow = 6.76 cfs @ 12.07 hrs, Volume= 21,513 cf, Atten= 0%, Lag= 0.0 min
Primary = 6.76 cfs @ 12.07 hrs, Volume= 21,513 cf
Routed to Link DP1 : Drainage System #1

Routing by Stor-Ind method, Time Span= 0.00-48.00 hrs, dt= 0.01 hrs

Peak Elev= 20.76' @ 12.07 hrs

Device	Routing	Invert	Outlet Devices
#1	Primary	17.95'	15.0" Round CMP_Round 15" L= 90.0' CMP, square edge headwall, Ke= 0.500 Inlet / Outlet Invert= 17.95' / 17.81' S= 0.0016 1' Cc= 0.900 n= 0.013 Concrete pipe, bends & connections, Flow Area= 1.23 sf

Primary OutFlow Max=6.76 cfs @ 12.07 hrs HW=20.75' (Free Discharge)

↑1=CMP_Round 15" (Barrel Controls 6.76 cfs @ 5.51 fps)

Summary for Pond 2a: CB6

[57] Hint: Peaked at 19.43' (Flood elevation advised)

Inflow Area = 88,068 sf, 44.32% Impervious, Inflow Depth = 3.13" for 25-yr event
Inflow = 4.19 cfs @ 12.39 hrs, Volume= 22,954 cf
Outflow = 4.19 cfs @ 12.39 hrs, Volume= 22,954 cf, Atten= 0%, Lag= 0.0 min
Primary = 4.19 cfs @ 12.39 hrs, Volume= 22,954 cf
Routed to Pond 2b : CB5

Routing by Stor-Ind method, Time Span= 0.00-48.00 hrs, dt= 0.01 hrs

Peak Elev= 19.43' @ 12.39 hrs

Device	Routing	Invert	Outlet Devices
#1	Primary	18.09'	18.0" Round Culvert

Proposed Conditions 2023-09-19

Prepared by Haley Ward

HydroCAD® 10.20-3g s/n 00801 © 2023 HydroCAD Software Solutions LLC

Type III 24-hr 25-yr Rainfall=7.13"

Printed 11/17/2023

Page 35

L= 58.0' CMP, square edge headwall, Ke= 0.500
Inlet / Outlet Invert= 18.09' / 18.02' S= 0.0012 '/ Cc= 0.900
n= 0.013 Concrete pipe, bends & connections, Flow Area= 1.77 sf

Primary OutFlow Max=4.19 cfs @ 12.39 hrs HW=19.43' (Free Discharge)
↑1=Culvert (Barrel Controls 4.19 cfs @ 3.32 fps)

Summary for Pond 2b: CB5

[57] Hint: Peaked at 19.58' (Flood elevation advised)
[81] Warning: Exceeded Pond 2a by 0.53' @ 12.07 hrs

Inflow Area = 104,728 sf, 51.59% Impervious, Inflow Depth = 3.61" for 25-yr event
Inflow = 5.00 cfs @ 12.36 hrs, Volume= 31,539 cf
Outflow = 5.00 cfs @ 12.36 hrs, Volume= 31,539 cf, Atten= 0%, Lag= 0.0 min
Primary = 5.00 cfs @ 12.36 hrs, Volume= 31,539 cf
Routed to Pond 2c : CB4

Routing by Stor-Ind method, Time Span= 0.00-48.00 hrs, dt= 0.01 hrs
Peak Elev= 19.58' @ 12.36 hrs

Device	Routing	Invert	Outlet Devices
#1	Primary	18.02'	18.0" Round Culvert L= 96.0' CMP, square edge headwall, Ke= 0.500 Inlet / Outlet Invert= 18.02' / 17.90' S= 0.0013 '/ Cc= 0.900 n= 0.013 Concrete pipe, bends & connections, Flow Area= 1.77 sf

Primary OutFlow Max=5.00 cfs @ 12.36 hrs HW=19.58' (Free Discharge)
↑1=Culvert (Barrel Controls 5.00 cfs @ 3.39 fps)

Summary for Pond 2c: CB4

[57] Hint: Peaked at 20.06' (Flood elevation advised)
[81] Warning: Exceeded Pond 2b by 0.56' @ 12.07 hrs

Inflow Area = 119,772 sf, 57.67% Impervious, Inflow Depth = 4.03" for 25-yr event
Inflow = 7.18 cfs @ 12.08 hrs, Volume= 40,177 cf
Outflow = 7.18 cfs @ 12.08 hrs, Volume= 40,177 cf, Atten= 0%, Lag= 0.0 min
Primary = 7.18 cfs @ 12.08 hrs, Volume= 40,177 cf
Routed to Pond 2d : CB3

Routing by Stor-Ind method, Time Span= 0.00-48.00 hrs, dt= 0.01 hrs
Peak Elev= 20.06' @ 12.08 hrs

Device	Routing	Invert	Outlet Devices
#1	Primary	17.90'	18.0" Round Culvert L= 81.0' CMP, square edge headwall, Ke= 0.500 Inlet / Outlet Invert= 17.90' / 17.80' S= 0.0012 '/ Cc= 0.900 n= 0.013 Concrete pipe, bends & connections, Flow Area= 1.77 sf

Primary OutFlow Max=7.17 cfs @ 12.08 hrs HW=20.06' (Free Discharge)
↑1=Culvert (Barrel Controls 7.17 cfs @ 4.06 fps)

Proposed Conditions 2023-09-19

Prepared by Haley Ward

HydroCAD® 10.20-3g s/n 00801 © 2023 HydroCAD Software Solutions LLC

Type III 24-hr 25-yr Rainfall=7.13"

Printed 11/17/2023

Page 36

Summary for Pond 2d: CB3

[57] Hint: Peaked at 19.78' (Flood elevation advised)

[79] Warning: Submerged Pond 2c Primary device # 1 INLET by 1.88'

Inflow Area = 128,179 sf, 60.44% Impervious, Inflow Depth = 4.21" for 25-yr event
 Inflow = 8.57 cfs @ 12.08 hrs, Volume= 45,005 cf
 Outflow = 8.57 cfs @ 12.08 hrs, Volume= 45,005 cf, Atten= 0%, Lag= 0.0 min
 Primary = 8.57 cfs @ 12.08 hrs, Volume= 45,005 cf
 Routed to Pond 2e : DMH 3

Routing by Stor-Ind method, Time Span= 0.00-48.00 hrs, dt= 0.01 hrs
 Peak Elev= 19.78' @ 12.08 hrs

Device	Routing	Invert	Outlet Devices
#1	Primary	17.70'	18.0" Round Culvert L= 7.0' CMP, square edge headwall, Ke= 0.500 Inlet / Outlet Invert= 17.70' / 17.69' S= 0.0014 '/ Cc= 0.900 n= 0.013 Concrete pipe, bends & connections, Flow Area= 1.77 sf

Primary OutFlow Max=8.56 cfs @ 12.08 hrs HW=19.78' (Free Discharge)

↑**1=Culvert** (Barrel Controls 8.56 cfs @ 4.84 fps)

Summary for Pond 2e: DMH 3

[57] Hint: Peaked at 19.17' (Flood elevation advised)

[79] Warning: Submerged Pond 2d Primary device # 1 INLET by 1.46'

Inflow Area = 128,179 sf, 60.44% Impervious, Inflow Depth = 4.21" for 25-yr event
 Inflow = 8.57 cfs @ 12.08 hrs, Volume= 45,005 cf
 Outflow = 8.57 cfs @ 12.08 hrs, Volume= 45,005 cf, Atten= 0%, Lag= 0.0 min
 Primary = 8.57 cfs @ 12.08 hrs, Volume= 45,005 cf
 Routed to Pond 2f : Jellyfish

Routing by Stor-Ind method, Time Span= 0.00-48.00 hrs, dt= 0.01 hrs
 Peak Elev= 19.17' @ 12.08 hrs

Device	Routing	Invert	Outlet Devices
#1	Primary	17.44'	24.0" Round Culvert L= 36.0' CMP, square edge headwall, Ke= 0.500 Inlet / Outlet Invert= 17.44' / 17.41' S= 0.0008 '/ Cc= 0.900 n= 0.013 Concrete pipe, bends & connections, Flow Area= 3.14 sf

Primary OutFlow Max=8.56 cfs @ 12.08 hrs HW=19.16' (Free Discharge)

↑**1=Culvert** (Barrel Controls 8.56 cfs @ 3.98 fps)

Summary for Pond 2f: Jellyfish

[57] Hint: Peaked at 19.01' (Flood elevation advised)

[79] Warning: Submerged Pond 2e Primary device # 1 INLET by 1.57'

Inflow Area = 128,179 sf, 60.44% Impervious, Inflow Depth = 4.21" for 25-yr event
 Inflow = 8.57 cfs @ 12.08 hrs, Volume= 45,005 cf
 Outflow = 8.57 cfs @ 12.08 hrs, Volume= 45,005 cf, Atten= 0%, Lag= 0.0 min
 Primary = 8.57 cfs @ 12.08 hrs, Volume= 45,005 cf
 Routed to Link DP2 : Drainage System #2 (CB1)

Routing by Stor-Ind method, Time Span= 0.00-48.00 hrs, dt= 0.01 hrs
 Peak Elev= 19.01' @ 12.08 hrs

Device	Routing	Invert	Outlet Devices
#1	Primary	17.31'	24.0" Round Culvert L= 22.0' CMP, square edge headwall, Ke= 0.500 Inlet / Outlet Invert= 17.31' / 17.29' S= 0.0009 '/ Cc= 0.900 n= 0.013 Concrete pipe, bends & connections, Flow Area= 3.14 sf

Primary OutFlow Max=8.56 cfs @ 12.08 hrs HW=19.00' (Free Discharge)
 ←1=Culvert (Barrel Controls 8.56 cfs @ 4.06 fps)

Summary for Link DP1: Drainage System #1

Inflow Area = 50,887 sf, 82.21% Impervious, Inflow Depth = 5.70" for 25-yr event
 Inflow = 7.53 cfs @ 12.07 hrs, Volume= 24,151 cf
 Primary = 7.53 cfs @ 12.07 hrs, Volume= 24,151 cf, Atten= 0%, Lag= 0.0 min
 Routed to nonexistent node 2R

Primary outflow = Inflow, Time Span= 0.00-48.00 hrs, dt= 0.01 hrs

Summary for Link DP2: Drainage System #2 (CB1)

Inflow Area = 138,014 sf, 59.98% Impervious, Inflow Depth = 4.19" for 25-yr event
 Inflow = 9.62 cfs @ 12.08 hrs, Volume= 48,147 cf
 Primary = 9.62 cfs @ 12.08 hrs, Volume= 48,147 cf, Atten= 0%, Lag= 0.0 min
 Routed to nonexistent node 2R

Primary outflow = Inflow, Time Span= 0.00-48.00 hrs, dt= 0.01 hrs

Proposed Conditions 2023-09-19

Prepared by Haley Ward

HydroCAD® 10.20-3g s/n 00801 © 2023 HydroCAD Software Solutions LLC

Type III 24-hr 50-yr Rainfall=8.53"

Printed 11/17/2023

Page 38

Time span=0.00-48.00 hrs, dt=0.01 hrs, 4801 points
 Runoff by SCS TR-20 method, UH=SCS, Weighted-CN
 Reach routing by Stor-Ind+Trans method - Pond routing by Stor-Ind method

Subcatchment O1: Off-Site	Runoff Area=79,768 sf 45.80% Impervious Runoff Depth=4.33" Flow Length=584' Tc=27.6 min CN=65 Runoff=5.43 cfs 28,763 cf
Subcatchment P1a: PS1a	Runoff Area=20,120 sf 64.85% Impervious Runoff Depth=5.76" Tc=5.0 min CN=77 Runoff=3.20 cfs 9,662 cf
Subcatchment P1b: PS1b	Runoff Area=26,173 sf 92.50% Impervious Runoff Depth=7.81" Tc=5.0 min CN=94 Runoff=5.13 cfs 17,032 cf
Subcatchment P1c: PS1c	Runoff Area=4,594 sf 99.65% Impervious Runoff Depth=8.29" Tc=5.0 min CN=98 Runoff=0.92 cfs 3,174 cf
Subcatchment P2a: PS2a	Runoff Area=8,300 sf 30.05% Impervious Runoff Depth=3.38" Tc=5.0 min CN=57 Runoff=0.77 cfs 2,341 cf
Subcatchment P2b: PS2b	Runoff Area=16,660 sf 89.99% Impervious Runoff Depth=7.57" Tc=5.0 min CN=92 Runoff=3.22 cfs 10,508 cf
Subcatchment P2c: PS2c	Runoff Area=15,044 sf 100.00% Impervious Runoff Depth=8.29" Tc=5.0 min CN=98 Runoff=3.00 cfs 10,393 cf
Subcatchment P2d: PS2d	Runoff Area=8,407 sf 100.00% Impervious Runoff Depth=8.29" Tc=5.0 min CN=98 Runoff=1.67 cfs 5,808 cf
Subcatchment P3: PS3	Runoff Area=9,835 sf 54.01% Impervious Runoff Depth=5.04" Tc=5.0 min CN=71 Runoff=1.38 cfs 4,133 cf
Pond 1a: CB7	Peak Elev=22.28' Inflow=3.20 cfs 9,662 cf 12.0" Round Culvert n=0.013 L=183.0' S=0.0167 '/' Outflow=3.20 cfs 9,662 cf
Pond 1b: CB2	Peak Elev=21.63' Inflow=8.33 cfs 26,694 cf 15.0" Round Culvert n=0.013 L=90.0' S=0.0016 '/' Outflow=8.33 cfs 26,694 cf
Pond 2a: CB6	Peak Elev=19.74' Inflow=5.71 cfs 31,104 cf 18.0" Round Culvert n=0.013 L=58.0' S=0.0012 '/' Outflow=5.71 cfs 31,104 cf
Pond 2b: CB5	Peak Elev=20.13' Inflow=6.71 cfs 41,611 cf 18.0" Round Culvert n=0.013 L=96.0' S=0.0013 '/' Outflow=6.71 cfs 41,611 cf
Pond 2c: CB4	Peak Elev=20.54' Inflow=9.13 cfs 52,004 cf 18.0" Round Culvert n=0.013 L=81.0' S=0.0012 '/' Outflow=9.13 cfs 52,004 cf
Pond 2d: CB3	Peak Elev=20.13' Inflow=10.79 cfs 57,812 cf 18.0" Round Culvert n=0.013 L=7.0' S=0.0014 '/' Outflow=10.79 cfs 57,812 cf
Pond 2e: DMH 3	Peak Elev=19.43' Inflow=10.79 cfs 57,812 cf 24.0" Round Culvert n=0.013 L=36.0' S=0.0008 '/' Outflow=10.79 cfs 57,812 cf

Proposed Conditions 2023-09-19

Prepared by Haley Ward

HydroCAD® 10.20-3g s/n 00801 © 2023 HydroCAD Software Solutions LLC

Type III 24-hr 50-yr Rainfall=8.53"

Printed 11/17/2023

Page 39

Pond 2f: Jellyfish

Peak Elev=19.27' Inflow=10.79 cfs 57,812 cf
24.0" Round Culvert n=0.013 L=22.0' S=0.0009 '/' Outflow=10.79 cfs 57,812 cf

Link DP1: Drainage System #1

Inflow=9.24 cfs 29,868 cf
Primary=9.24 cfs 29,868 cf

Link DP2: Drainage System #2 (CB1)

Inflow=12.18 cfs 61,945 cf
Primary=12.18 cfs 61,945 cf

Total Runoff Area = 188,901 sf Runoff Volume = 91,813 cf Average Runoff Depth = 5.83"
34.03% Pervious = 64,280 sf 65.97% Impervious = 124,621 sf

Proposed Conditions 2023-09-19

Prepared by Haley Ward

HydroCAD® 10.20-3g s/n 00801 © 2023 HydroCAD Software Solutions LLC

Type III 24-hr 50-yr Rainfall=8.53"

Printed 11/17/2023

Page 40

Summary for Subcatchment O1: Off-Site

[47] Hint: Peak is 249% of capacity of segment #3

Runoff = 5.43 cfs @ 12.39 hrs, Volume= 28,763 cf, Depth= 4.33"
Routed to Pond 2a : CB6

Runoff by SCS TR-20 method, UH=SCS, Weighted-CN, Time Span= 0.00-48.00 hrs, dt= 0.01 hrs
Type III 24-hr 50-yr Rainfall=8.53"

Area (sf)	CN	Description
2,453	98	Unconnected roofs, HSG A
34,084	98	Paved parking, HSG A
22,052	36	Woods, Fair, HSG A
21,179	39	>75% Grass cover, Good, HSG A
79,768	65	Weighted Average
43,231		54.20% Pervious Area
36,537		45.80% Impervious Area
2,453		6.71% Unconnected

Tc (min)	Length (feet)	Slope (ft/ft)	Velocity (ft/sec)	Capacity (cfs)	Description
19.6	100	0.0250	0.08		Sheet Flow, Woods: Light underbrush n= 0.400 P2= 3.20"
7.3	374	0.0150	0.86		Shallow Concentrated Flow, Short Grass Pasture Kv= 7.0 fps
0.7	110	0.0050	2.78	2.18	Pipe Channel, RCP_Round 12" 12.0" Round Area= 0.8 sf Perim= 3.1' r= 0.25' n= 0.015 Concrete sewer w/manholes & inlets
27.6	584	Total			

Summary for Subcatchment P1a: PS1a

Runoff = 3.20 cfs @ 12.07 hrs, Volume= 9,662 cf, Depth= 5.76"
Routed to Pond 1a : CB7

Runoff by SCS TR-20 method, UH=SCS, Weighted-CN, Time Span= 0.00-48.00 hrs, dt= 0.01 hrs
Type III 24-hr 50-yr Rainfall=8.53"

Area (sf)	CN	Description
8,481	98	Paved parking, HSG A
4,566	98	Roofs, HSG A
7,073	39	>75% Grass cover, Good, HSG A
20,120	77	Weighted Average
7,073		35.15% Pervious Area
13,047		64.85% Impervious Area

Proposed Conditions 2023-09-19

Prepared by Haley Ward

HydroCAD® 10.20-3g s/n 00801 © 2023 HydroCAD Software Solutions LLC

Type III 24-hr 50-yr Rainfall=8.53"

Printed 11/17/2023

Page 41

Tc (min)	Length (feet)	Slope (ft/ft)	Velocity (ft/sec)	Capacity (cfs)	Description
5.0					Direct Entry,

Summary for Subcatchment P1b: PS1b

Runoff = 5.13 cfs @ 12.07 hrs, Volume= 17,032 cf, Depth= 7.81"
 Routed to Pond 1b : CB2

Runoff by SCS TR-20 method, UH=SCS, Weighted-CN, Time Span= 0.00-48.00 hrs, dt= 0.01 hrs
 Type III 24-hr 50-yr Rainfall=8.53"

Area (sf)	CN	Description
10,744	98	Paved parking, HSG A
13,465	98	Roofs, HSG A
1,964	39	>75% Grass cover, Good, HSG A
26,173	94	Weighted Average
1,964		7.50% Pervious Area
24,209		92.50% Impervious Area

Tc (min)	Length (feet)	Slope (ft/ft)	Velocity (ft/sec)	Capacity (cfs)	Description
5.0					Direct Entry,

Summary for Subcatchment P1c: PS1c

Runoff = 0.92 cfs @ 12.07 hrs, Volume= 3,174 cf, Depth= 8.29"
 Routed to Link DP1 : Drainage System #1

Runoff by SCS TR-20 method, UH=SCS, Weighted-CN, Time Span= 0.00-48.00 hrs, dt= 0.01 hrs
 Type III 24-hr 50-yr Rainfall=8.53"

Area (sf)	CN	Description
4,578	98	Paved parking, HSG A
16	39	>75% Grass cover, Good, HSG A
4,594	98	Weighted Average
16		0.35% Pervious Area
4,578		99.65% Impervious Area

Tc (min)	Length (feet)	Slope (ft/ft)	Velocity (ft/sec)	Capacity (cfs)	Description
5.0					Direct Entry,

Summary for Subcatchment P2a: PS2a

Runoff = 0.77 cfs @ 12.08 hrs, Volume= 2,341 cf, Depth= 3.38"
 Routed to Pond 2a : CB6

Runoff by SCS TR-20 method, UH=SCS, Weighted-CN, Time Span= 0.00-48.00 hrs, dt= 0.01 hrs
 Type III 24-hr 50-yr Rainfall=8.53"

Proposed Conditions 2023-09-19

Prepared by Haley Ward

HydroCAD® 10.20-3g s/n 00801 © 2023 HydroCAD Software Solutions LLC

Type III 24-hr 50-yr Rainfall=8.53"

Printed 11/17/2023

Page 42

Area (sf)	CN	Description
2,465	98	Paved parking, HSG A
29	98	Roofs, HSG A
5,806	39	>75% Grass cover, Good, HSG A
8,300	57	Weighted Average
5,806		69.95% Pervious Area
2,494		30.05% Impervious Area

Tc (min)	Length (feet)	Slope (ft/ft)	Velocity (ft/sec)	Capacity (cfs)	Description
5.0					Direct Entry,

Summary for Subcatchment P2b: PS2b

Runoff = 3.22 cfs @ 12.07 hrs, Volume= 10,508 cf, Depth= 7.57"
 Routed to Pond 2b : CB5

Runoff by SCS TR-20 method, UH=SCS, Weighted-CN, Time Span= 0.00-48.00 hrs, dt= 0.01 hrs
 Type III 24-hr 50-yr Rainfall=8.53"

Area (sf)	CN	Description
6,157	98	Paved parking, HSG A
8,836	98	Roofs, HSG A
1,667	39	>75% Grass cover, Good, HSG A
16,660	92	Weighted Average
1,667		10.01% Pervious Area
14,993		89.99% Impervious Area

Tc (min)	Length (feet)	Slope (ft/ft)	Velocity (ft/sec)	Capacity (cfs)	Description
5.0					Direct Entry,

Summary for Subcatchment P2c: PS2c

Runoff = 3.00 cfs @ 12.07 hrs, Volume= 10,393 cf, Depth= 8.29"
 Routed to Pond 2c : CB4

Runoff by SCS TR-20 method, UH=SCS, Weighted-CN, Time Span= 0.00-48.00 hrs, dt= 0.01 hrs
 Type III 24-hr 50-yr Rainfall=8.53"

Area (sf)	CN	Description
3,896	98	Paved parking, HSG A
11,148	98	Roofs, HSG A
15,044	98	Weighted Average
15,044		100.00% Impervious Area

Proposed Conditions 2023-09-19

Prepared by Haley Ward

HydroCAD® 10.20-3g s/n 00801 © 2023 HydroCAD Software Solutions LLC

Type III 24-hr 50-yr Rainfall=8.53"

Printed 11/17/2023

Page 43

Tc (min)	Length (feet)	Slope (ft/ft)	Velocity (ft/sec)	Capacity (cfs)	Description
5.0					Direct Entry,

Summary for Subcatchment P2d: PS2d

Runoff = 1.67 cfs @ 12.07 hrs, Volume= 5,808 cf, Depth= 8.29"
Routed to Pond 2d : CB3

Runoff by SCS TR-20 method, UH=SCS, Weighted-CN, Time Span= 0.00-48.00 hrs, dt= 0.01 hrs
Type III 24-hr 50-yr Rainfall=8.53"

Area (sf)	CN	Description
2,897	98	Paved parking, HSG A
5,510	98	Roofs, HSG A
8,407	98	Weighted Average
8,407		100.00% Impervious Area

Tc (min)	Length (feet)	Slope (ft/ft)	Velocity (ft/sec)	Capacity (cfs)	Description
5.0					Direct Entry,

Summary for Subcatchment P3: PS3

Runoff = 1.38 cfs @ 12.07 hrs, Volume= 4,133 cf, Depth= 5.04"
Routed to Link DP2 : Drainage System #2 (CB1)

Runoff by SCS TR-20 method, UH=SCS, Weighted-CN, Time Span= 0.00-48.00 hrs, dt= 0.01 hrs
Type III 24-hr 50-yr Rainfall=8.53"

Area (sf)	CN	Description
5,312	98	Paved parking, HSG A
4,523	39	>75% Grass cover, Good, HSG A
9,835	71	Weighted Average
4,523		45.99% Pervious Area
5,312		54.01% Impervious Area

Tc (min)	Length (feet)	Slope (ft/ft)	Velocity (ft/sec)	Capacity (cfs)	Description
5.0					Direct Entry,

Summary for Pond 1a: CB7

[57] Hint: Peaked at 22.28' (Flood elevation advised)

Inflow Area = 20,120 sf, 64.85% Impervious, Inflow Depth = 5.76" for 50-yr event
Inflow = 3.20 cfs @ 12.07 hrs, Volume= 9,662 cf
Outflow = 3.20 cfs @ 12.07 hrs, Volume= 9,662 cf, Atten= 0%, Lag= 0.0 min
Primary = 3.20 cfs @ 12.07 hrs, Volume= 9,662 cf
Routed to Pond 1b : CB2

Proposed Conditions 2023-09-19

Prepared by Haley Ward

HydroCAD® 10.20-3g s/n 00801 © 2023 HydroCAD Software Solutions LLC

Type III 24-hr 50-yr Rainfall=8.53"

Printed 11/17/2023

Page 44

Routing by Stor-Ind method, Time Span= 0.00-48.00 hrs, dt= 0.01 hrs

Peak Elev= 22.28' @ 12.07 hrs

Device	Routing	Invert	Outlet Devices
#1	Primary	21.06'	12.0" Round CMP_Round 12" L= 183.0' CMP, square edge headwall, Ke= 0.500 Inlet / Outlet Invert= 21.06' / 18.00' S= 0.0167 1' Cc= 0.900 n= 0.013 Concrete pipe, bends & connections, Flow Area= 0.79 sf

Primary OutFlow Max=3.19 cfs @ 12.07 hrs HW=22.27' (Free Discharge)

↑1=CMP_Round 12" (Inlet Controls 3.19 cfs @ 4.07 fps)

Summary for Pond 1b: CB2

[57] Hint: Peaked at 21.63' (Flood elevation advised)

[79] Warning: Submerged Pond 1a Primary device # 1 INLET by 0.57'

Inflow Area = 46,293 sf, 80.48% Impervious, Inflow Depth = 6.92" for 50-yr event
 Inflow = 8.33 cfs @ 12.07 hrs, Volume= 26,694 cf
 Outflow = 8.33 cfs @ 12.07 hrs, Volume= 26,694 cf, Atten= 0%, Lag= 0.0 min
 Primary = 8.33 cfs @ 12.07 hrs, Volume= 26,694 cf
 Routed to Link DP1 : Drainage System #1

Routing by Stor-Ind method, Time Span= 0.00-48.00 hrs, dt= 0.01 hrs

Peak Elev= 21.63' @ 12.07 hrs

Device	Routing	Invert	Outlet Devices
#1	Primary	17.95'	15.0" Round CMP_Round 15" L= 90.0' CMP, square edge headwall, Ke= 0.500 Inlet / Outlet Invert= 17.95' / 17.81' S= 0.0016 1' Cc= 0.900 n= 0.013 Concrete pipe, bends & connections, Flow Area= 1.23 sf

Primary OutFlow Max=8.32 cfs @ 12.07 hrs HW=21.63' (Free Discharge)

↑1=CMP_Round 15" (Barrel Controls 8.32 cfs @ 6.78 fps)

Summary for Pond 2a: CB6

[57] Hint: Peaked at 19.74' (Flood elevation advised)

Inflow Area = 88,068 sf, 44.32% Impervious, Inflow Depth = 4.24" for 50-yr event
 Inflow = 5.71 cfs @ 12.37 hrs, Volume= 31,104 cf
 Outflow = 5.71 cfs @ 12.37 hrs, Volume= 31,104 cf, Atten= 0%, Lag= 0.0 min
 Primary = 5.71 cfs @ 12.37 hrs, Volume= 31,104 cf
 Routed to Pond 2b : CB5

Routing by Stor-Ind method, Time Span= 0.00-48.00 hrs, dt= 0.01 hrs

Peak Elev= 19.74' @ 12.37 hrs

Device	Routing	Invert	Outlet Devices
#1	Primary	18.09'	18.0" Round Culvert

Proposed Conditions 2023-09-19

Type III 24-hr 50-yr Rainfall=8.53"

Prepared by Haley Ward

Printed 11/17/2023

HydroCAD® 10.20-3g s/n 00801 © 2023 HydroCAD Software Solutions LLC

Page 45

L= 58.0' CMP, square edge headwall, Ke= 0.500
Inlet / Outlet Invert= 18.09' / 18.02' S= 0.0012 '/ Cc= 0.900
n= 0.013 Concrete pipe, bends & connections, Flow Area= 1.77 sf

Primary OutFlow Max=5.71 cfs @ 12.37 hrs HW=19.74' (Free Discharge)
↑1=Culvert (Barrel Controls 5.71 cfs @ 3.66 fps)

Summary for Pond 2b: CB5

[57] Hint: Peaked at 20.13' (Flood elevation advised)
[81] Warning: Exceeded Pond 2a by 0.70' @ 12.08 hrs

Inflow Area = 104,728 sf, 51.59% Impervious, Inflow Depth = 4.77" for 50-yr event
Inflow = 6.71 cfs @ 12.36 hrs, Volume= 41,611 cf
Outflow = 6.71 cfs @ 12.36 hrs, Volume= 41,611 cf, Atten= 0%, Lag= 0.0 min
Primary = 6.71 cfs @ 12.36 hrs, Volume= 41,611 cf
Routed to Pond 2c : CB4

Routing by Stor-Ind method, Time Span= 0.00-48.00 hrs, dt= 0.01 hrs
Peak Elev= 20.13' @ 12.36 hrs

Device	Routing	Invert	Outlet Devices
#1	Primary	18.02'	18.0" Round Culvert L= 96.0' CMP, square edge headwall, Ke= 0.500 Inlet / Outlet Invert= 18.02' / 17.90' S= 0.0013 '/ Cc= 0.900 n= 0.013 Concrete pipe, bends & connections, Flow Area= 1.77 sf

Primary OutFlow Max=6.71 cfs @ 12.36 hrs HW=20.13' (Free Discharge)
↑1=Culvert (Barrel Controls 6.71 cfs @ 3.80 fps)

Summary for Pond 2c: CB4

[57] Hint: Peaked at 20.54' (Flood elevation advised)
[81] Warning: Exceeded Pond 2b by 0.67' @ 12.06 hrs

Inflow Area = 119,772 sf, 57.67% Impervious, Inflow Depth = 5.21" for 50-yr event
Inflow = 9.13 cfs @ 12.08 hrs, Volume= 52,004 cf
Outflow = 9.13 cfs @ 12.08 hrs, Volume= 52,004 cf, Atten= 0%, Lag= 0.0 min
Primary = 9.13 cfs @ 12.08 hrs, Volume= 52,004 cf
Routed to Pond 2d : CB3

Routing by Stor-Ind method, Time Span= 0.00-48.00 hrs, dt= 0.01 hrs
Peak Elev= 20.54' @ 12.08 hrs

Device	Routing	Invert	Outlet Devices
#1	Primary	17.90'	18.0" Round Culvert L= 81.0' CMP, square edge headwall, Ke= 0.500 Inlet / Outlet Invert= 17.90' / 17.80' S= 0.0012 '/ Cc= 0.900 n= 0.013 Concrete pipe, bends & connections, Flow Area= 1.77 sf

Primary OutFlow Max=9.13 cfs @ 12.08 hrs HW=20.54' (Free Discharge)
↑1=Culvert (Barrel Controls 9.13 cfs @ 5.17 fps)

Proposed Conditions 2023-09-19

Prepared by Haley Ward

HydroCAD® 10.20-3g s/n 00801 © 2023 HydroCAD Software Solutions LLC

Type III 24-hr 50-yr Rainfall=8.53"

Printed 11/17/2023

Page 46

Summary for Pond 2d: CB3

[57] Hint: Peaked at 20.13' (Flood elevation advised)

[79] Warning: Submerged Pond 2c Primary device # 1 INLET by 2.23'

Inflow Area = 128,179 sf, 60.44% Impervious, Inflow Depth = 5.41" for 50-yr event
 Inflow = 10.79 cfs @ 12.08 hrs, Volume= 57,812 cf
 Outflow = 10.79 cfs @ 12.08 hrs, Volume= 57,812 cf, Atten= 0%, Lag= 0.0 min
 Primary = 10.79 cfs @ 12.08 hrs, Volume= 57,812 cf
 Routed to Pond 2e : DMH 3

Routing by Stor-Ind method, Time Span= 0.00-48.00 hrs, dt= 0.01 hrs
 Peak Elev= 20.13' @ 12.08 hrs

Device	Routing	Invert	Outlet Devices
#1	Primary	17.70'	18.0" Round Culvert L= 7.0' CMP, square edge headwall, Ke= 0.500 Inlet / Outlet Invert= 17.70' / 17.69' S= 0.0014 '/ Cc= 0.900 n= 0.013 Concrete pipe, bends & connections, Flow Area= 1.77 sf

Primary OutFlow Max=10.78 cfs @ 12.08 hrs HW=20.13' (Free Discharge)

↑**1=Culvert** (Barrel Controls 10.78 cfs @ 6.10 fps)

Summary for Pond 2e: DMH 3

[57] Hint: Peaked at 19.43' (Flood elevation advised)

[79] Warning: Submerged Pond 2d Primary device # 1 INLET by 1.73'

Inflow Area = 128,179 sf, 60.44% Impervious, Inflow Depth = 5.41" for 50-yr event
 Inflow = 10.79 cfs @ 12.08 hrs, Volume= 57,812 cf
 Outflow = 10.79 cfs @ 12.08 hrs, Volume= 57,812 cf, Atten= 0%, Lag= 0.0 min
 Primary = 10.79 cfs @ 12.08 hrs, Volume= 57,812 cf
 Routed to Pond 2f : Jellyfish

Routing by Stor-Ind method, Time Span= 0.00-48.00 hrs, dt= 0.01 hrs
 Peak Elev= 19.43' @ 12.08 hrs

Device	Routing	Invert	Outlet Devices
#1	Primary	17.44'	24.0" Round Culvert L= 36.0' CMP, square edge headwall, Ke= 0.500 Inlet / Outlet Invert= 17.44' / 17.41' S= 0.0008 '/ Cc= 0.900 n= 0.013 Concrete pipe, bends & connections, Flow Area= 3.14 sf

Primary OutFlow Max=10.78 cfs @ 12.08 hrs HW=19.43' (Free Discharge)

↑**1=Culvert** (Barrel Controls 10.78 cfs @ 4.29 fps)

Summary for Pond 2f: Jellyfish

[57] Hint: Peaked at 19.27' (Flood elevation advised)

[79] Warning: Submerged Pond 2e Primary device # 1 INLET by 1.83'

Inflow Area = 128,179 sf, 60.44% Impervious, Inflow Depth = 5.41" for 50-yr event
 Inflow = 10.79 cfs @ 12.08 hrs, Volume= 57,812 cf
 Outflow = 10.79 cfs @ 12.08 hrs, Volume= 57,812 cf, Atten= 0%, Lag= 0.0 min
 Primary = 10.79 cfs @ 12.08 hrs, Volume= 57,812 cf
 Routed to Link DP2 : Drainage System #2 (CB1)

Routing by Stor-Ind method, Time Span= 0.00-48.00 hrs, dt= 0.01 hrs
 Peak Elev= 19.27' @ 12.08 hrs

Device	Routing	Invert	Outlet Devices
#1	Primary	17.31'	24.0" Round Culvert L= 22.0' CMP, square edge headwall, Ke= 0.500 Inlet / Outlet Invert= 17.31' / 17.29' S= 0.0009 '/ Cc= 0.900 n= 0.013 Concrete pipe, bends & connections, Flow Area= 3.14 sf

Primary OutFlow Max=10.78 cfs @ 12.08 hrs HW=19.26' (Free Discharge)

↑1=Culvert (Barrel Controls 10.78 cfs @ 4.37 fps)

Summary for Link DP1: Drainage System #1

Inflow Area = 50,887 sf, 82.21% Impervious, Inflow Depth = 7.04" for 50-yr event
 Inflow = 9.24 cfs @ 12.07 hrs, Volume= 29,868 cf
 Primary = 9.24 cfs @ 12.07 hrs, Volume= 29,868 cf, Atten= 0%, Lag= 0.0 min
 Routed to nonexistent node 2R

Primary outflow = Inflow, Time Span= 0.00-48.00 hrs, dt= 0.01 hrs

Summary for Link DP2: Drainage System #2 (CB1)

Inflow Area = 138,014 sf, 59.98% Impervious, Inflow Depth = 5.39" for 50-yr event
 Inflow = 12.18 cfs @ 12.08 hrs, Volume= 61,945 cf
 Primary = 12.18 cfs @ 12.08 hrs, Volume= 61,945 cf, Atten= 0%, Lag= 0.0 min
 Routed to nonexistent node 2R

Primary outflow = Inflow, Time Span= 0.00-48.00 hrs, dt= 0.01 hrs

APPENDIX D
SOIL SURVEY INFORMATION



United States
Department of
Agriculture

NRCS

Natural
Resources
Conservation
Service

A product of the National
Cooperative Soil Survey,
a joint effort of the United
States Department of
Agriculture and other
Federal agencies, State
agencies including the
Agricultural Experiment
Stations, and local
participants

Custom Soil Resource Report for Rockingham County, New Hampshire

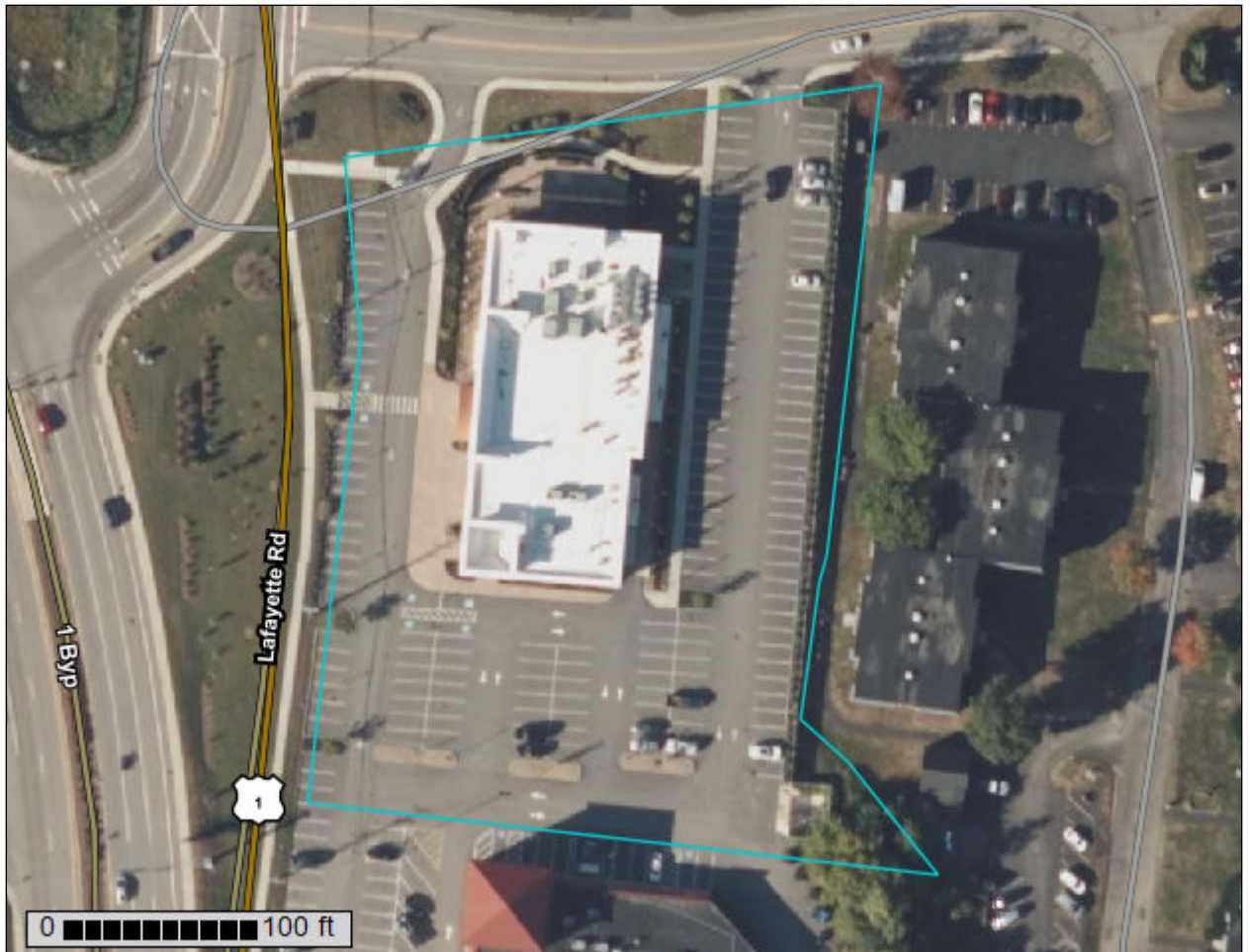

Custom Soil Resource Report Soil Map

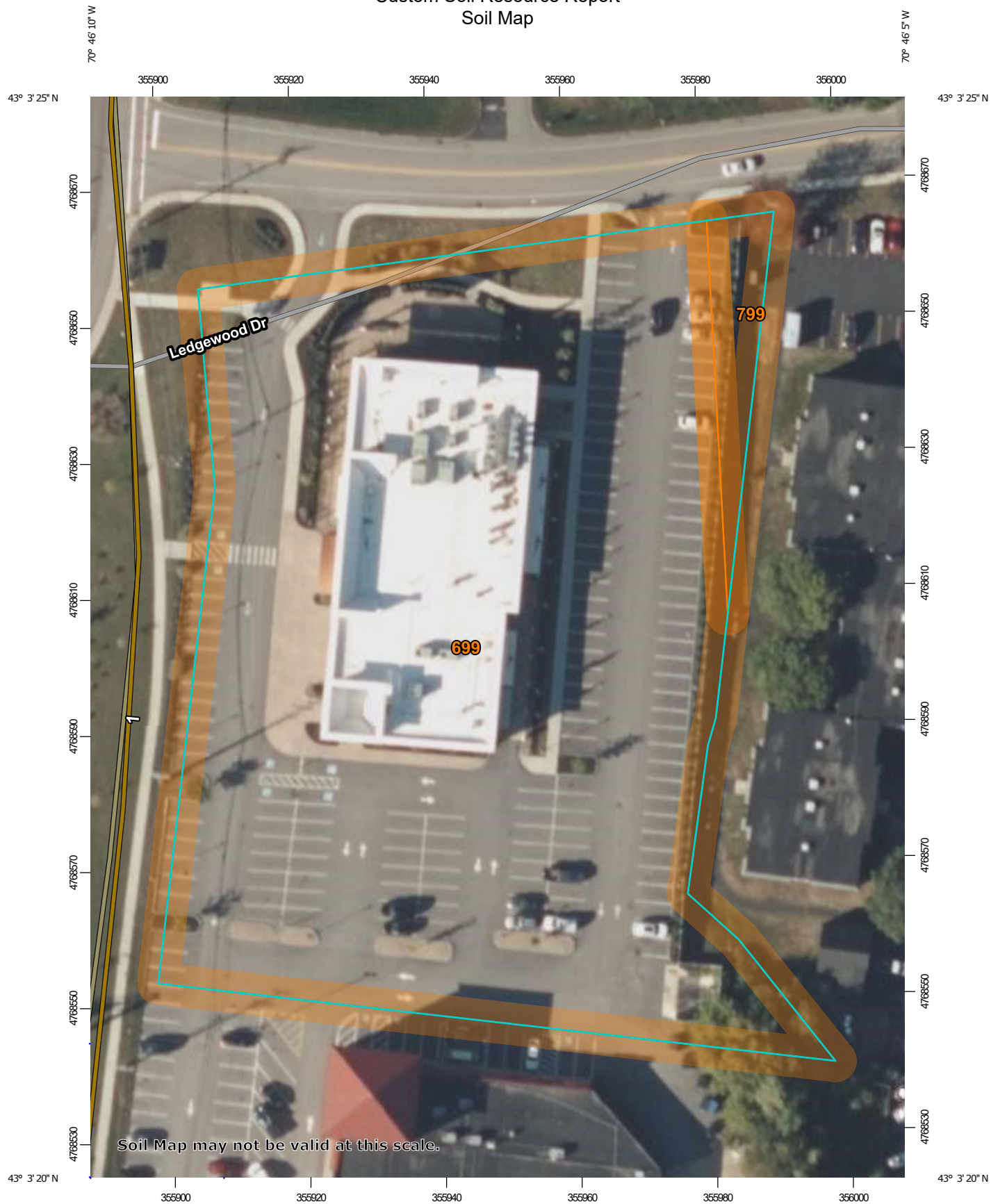

Soil Map may not be valid at this scale.

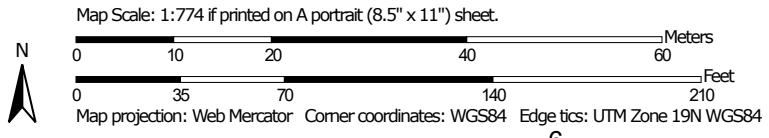

MAP LEGEND

Area of Interest (AOI)

 Area of Interest (AOI)



















Soils

 Soil Map Unit Polygons

 Soil Map Unit Lines

 Soil Map Unit Points

Special Point Features

-  Blowout
-  Borrow Pit
-  Clay Spot
-  Closed Depression
-  Gravel Pit
-  Gravelly Spot
-  Landfill
-  Lava Flow
-  Marsh or swamp
-  Mine or Quarry
-  Miscellaneous Water
-  Perennial Water
-  Rock Outcrop
-  Saline Spot
-  Sandy Spot
-  Severely Eroded Spot
-  Sinkhole
-  Slide or Slip
-  Sodic Spot

-  Spoil Area
-  Stony Spot
-  Very Stony Spot
-  Wet Spot
-  Other
-  Special Line Features

Water Features

 Streams and Canals

Transportation

-  Rails
-  Interstate Highways
-  US Routes
-  Major Roads
-  Local Roads

Background

 Aerial Photography

MAP INFORMATION

The soil surveys that comprise your AOI were mapped at 1:24,000.

Warning: Soil Map may not be valid at this scale.

Enlargement of maps beyond the scale of mapping can cause misunderstanding of the detail of mapping and accuracy of soil line placement. The maps do not show the small areas of contrasting soils that could have been shown at a more detailed scale.

Please rely on the bar scale on each map sheet for map measurements.

Source of Map: Natural Resources Conservation Service
 Web Soil Survey URL:
 Coordinate System: Web Mercator (EPSG:3857)

Maps from the Web Soil Survey are based on the Web Mercator projection, which preserves direction and shape but distorts distance and area. A projection that preserves area, such as the Albers equal-area conic projection, should be used if more accurate calculations of distance or area are required.

This product is generated from the USDA-NRCS certified data as of the version date(s) listed below.

Soil Survey Area: Rockingham County, New Hampshire
 Survey Area Data: Version 26, Aug 22, 2023

Soil map units are labeled (as space allows) for map scales 1:50,000 or larger.

Date(s) aerial images were photographed: Jun 19, 2020—Sep 20, 2020

The orthophoto or other base map on which the soil lines were compiled and digitized probably differs from the background imagery displayed on these maps. As a result, some minor shifting of map unit boundaries may be evident.

Map Unit Legend

Map Unit Symbol	Map Unit Name	Acres in AOI	Percent of AOI
699	Urban land	2.2	96.8%
799	Urban land-Canton complex, 3 to 15 percent slopes	0.1	3.2%
Totals for Area of Interest		2.3	100.0%

Map Unit Descriptions

The map units delineated on the detailed soil maps in a soil survey represent the soils or miscellaneous areas in the survey area. The map unit descriptions, along with the maps, can be used to determine the composition and properties of a unit.

A map unit delineation on a soil map represents an area dominated by one or more major kinds of soil or miscellaneous areas. A map unit is identified and named according to the taxonomic classification of the dominant soils. Within a taxonomic class there are precisely defined limits for the properties of the soils. On the landscape, however, the soils are natural phenomena, and they have the characteristic variability of all natural phenomena. Thus, the range of some observed properties may extend beyond the limits defined for a taxonomic class. Areas of soils of a single taxonomic class rarely, if ever, can be mapped without including areas of other taxonomic classes. Consequently, every map unit is made up of the soils or miscellaneous areas for which it is named and some minor components that belong to taxonomic classes other than those of the major soils.

Most minor soils have properties similar to those of the dominant soil or soils in the map unit, and thus they do not affect use and management. These are called noncontrasting, or similar, components. They may or may not be mentioned in a particular map unit description. Other minor components, however, have properties and behavioral characteristics divergent enough to affect use or to require different management. These are called contrasting, or dissimilar, components. They generally are in small areas and could not be mapped separately because of the scale used. Some small areas of strongly contrasting soils or miscellaneous areas are identified by a special symbol on the maps. If included in the database for a given area, the contrasting minor components are identified in the map unit descriptions along with some characteristics of each. A few areas of minor components may not have been observed, and consequently they are not mentioned in the descriptions, especially where the pattern was so complex that it was impractical to make enough observations to identify all the soils and miscellaneous areas on the landscape.

The presence of minor components in a map unit in no way diminishes the usefulness or accuracy of the data. The objective of mapping is not to delineate pure taxonomic classes but rather to separate the landscape into landforms or landform segments that have similar use and management requirements. The delineation of such segments on the map provides sufficient information for the development of resource plans. If intensive use of small areas is planned, however,

Custom Soil Resource Report

onsite investigation is needed to define and locate the soils and miscellaneous areas.

An identifying symbol precedes the map unit name in the map unit descriptions. Each description includes general facts about the unit and gives important soil properties and qualities.

Soils that have profiles that are almost alike make up a *soil series*. Except for differences in texture of the surface layer, all the soils of a series have major horizons that are similar in composition, thickness, and arrangement.

Soils of one series can differ in texture of the surface layer, slope, stoniness, salinity, degree of erosion, and other characteristics that affect their use. On the basis of such differences, a soil series is divided into *soil phases*. Most of the areas shown on the detailed soil maps are phases of soil series. The name of a soil phase commonly indicates a feature that affects use or management. For example, Alpha silt loam, 0 to 2 percent slopes, is a phase of the Alpha series.

Some map units are made up of two or more major soils or miscellaneous areas. These map units are complexes, associations, or undifferentiated groups.

A *complex* consists of two or more soils or miscellaneous areas in such an intricate pattern or in such small areas that they cannot be shown separately on the maps. The pattern and proportion of the soils or miscellaneous areas are somewhat similar in all areas. Alpha-Beta complex, 0 to 6 percent slopes, is an example.

An *association* is made up of two or more geographically associated soils or miscellaneous areas that are shown as one unit on the maps. Because of present or anticipated uses of the map units in the survey area, it was not considered practical or necessary to map the soils or miscellaneous areas separately. The pattern and relative proportion of the soils or miscellaneous areas are somewhat similar. Alpha-Beta association, 0 to 2 percent slopes, is an example.

An *undifferentiated group* is made up of two or more soils or miscellaneous areas that could be mapped individually but are mapped as one unit because similar interpretations can be made for use and management. The pattern and proportion of the soils or miscellaneous areas in a mapped area are not uniform. An area can be made up of only one of the major soils or miscellaneous areas, or it can be made up of all of them. Alpha and Beta soils, 0 to 2 percent slopes, is an example.

Some surveys include *miscellaneous areas*. Such areas have little or no soil material and support little or no vegetation. Rock outcrop is an example.

Rockingham County, New Hampshire

699—Urban land

Map Unit Composition

Urban land: 85 percent

Minor components: 15 percent

Estimates are based on observations, descriptions, and transects of the mapunit.

Minor Components

Not named

Percent of map unit: 15 percent

Hydric soil rating: No

799—Urban land-Canton complex, 3 to 15 percent slopes

Map Unit Setting

National map unit symbol: 9cq0

Elevation: 0 to 1,000 feet

Mean annual precipitation: 42 to 46 inches

Mean annual air temperature: 45 to 48 degrees F

Frost-free period: 120 to 160 days

Farmland classification: Not prime farmland

Map Unit Composition

Urban land: 55 percent

Canton and similar soils: 20 percent

Minor components: 25 percent

Estimates are based on observations, descriptions, and transects of the mapunit.

Description of Canton

Setting

Parent material: Till

Typical profile

H1 - 0 to 5 inches: gravelly fine sandy loam

H2 - 5 to 21 inches: gravelly fine sandy loam

H3 - 21 to 60 inches: loamy sand

Properties and qualities

Slope: 3 to 8 percent

Depth to restrictive feature: More than 80 inches

Drainage class: Well drained

Runoff class: Low

Capacity of the most limiting layer to transmit water (Ksat): High (2.00 to 6.00 in/hr)

Depth to water table: More than 80 inches

Frequency of flooding: None

Frequency of ponding: None

Available water supply, 0 to 60 inches: Low (about 5.3 inches)

Custom Soil Resource Report

Interpretive groups

Land capability classification (irrigated): None specified
Land capability classification (nonirrigated): 2e
Hydrologic Soil Group: A
Ecological site: F144AY034CT - Well Drained Till Uplands
Hydric soil rating: No

Minor Components

Udorthents

Percent of map unit: 5 percent
Hydric soil rating: No

Boxford and eldridge

Percent of map unit: 4 percent
Hydric soil rating: No

Squamscott and scitico

Percent of map unit: 4 percent
Landform: Marine terraces
Hydric soil rating: Yes

Scituate and newfields

Percent of map unit: 4 percent
Hydric soil rating: No

Chatfield

Percent of map unit: 4 percent
Hydric soil rating: No

Walpole

Percent of map unit: 4 percent
Landform: Depressions
Hydric soil rating: Yes

APPENDIX E
FEMA FIRM MAP

National Flood Hazard Layer FIRMette



70°46'27"W 43°3'37"N

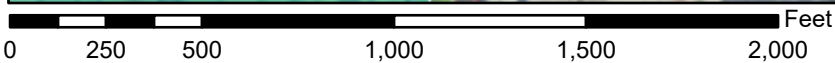
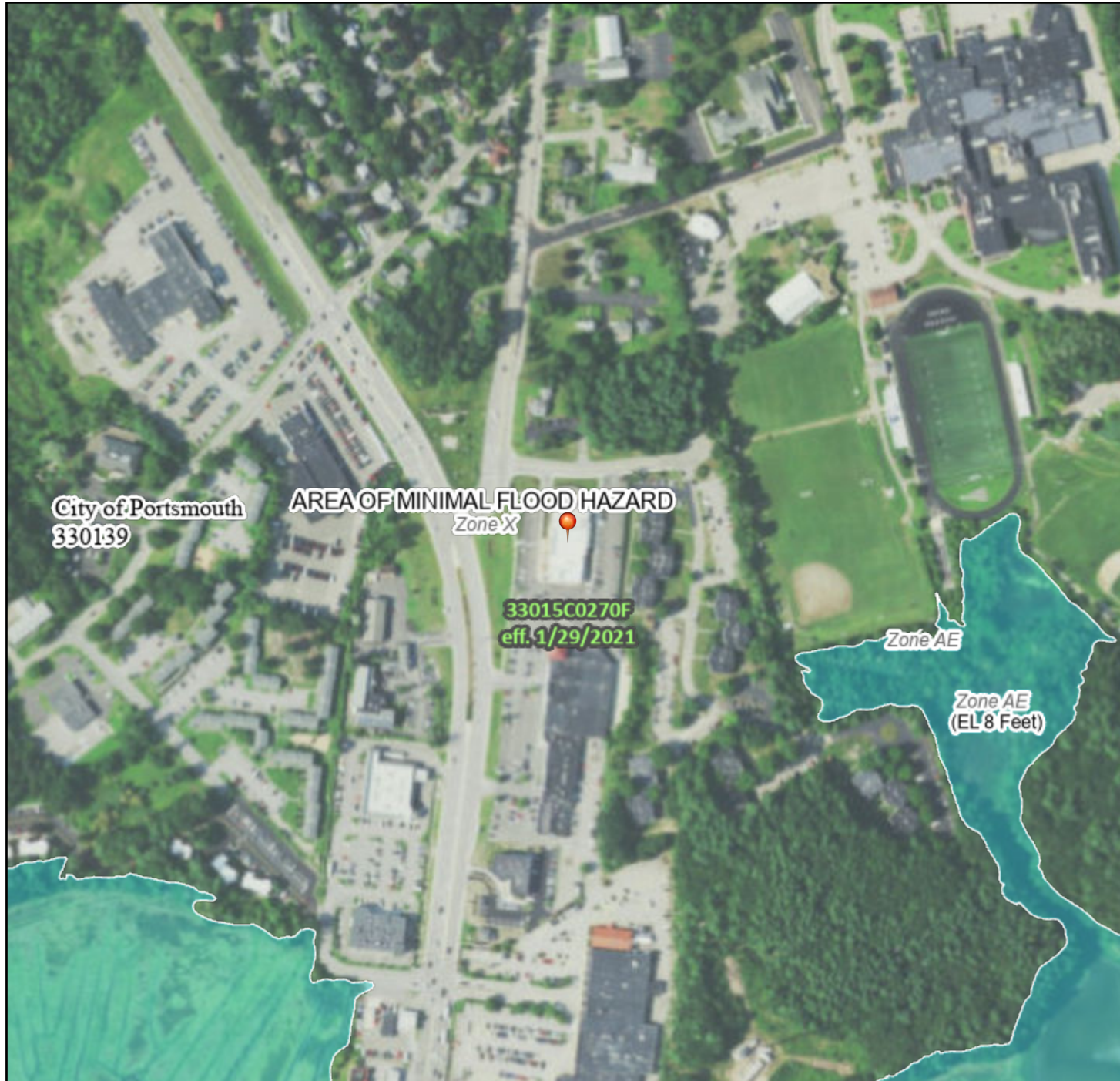

1:6,000

70°45'50"W 43°3'11"N

Basemap Imagery Source: USGS National Map 2023

Legend

SEE FIS REPORT FOR DETAILED LEGEND AND INDEX MAP FOR FIRM PANEL LAYOUT

SPECIAL FLOOD HAZARD AREAS		Without Base Flood Elevation (BFE) <i>Zone A, V, A99</i>
		With BFE or Depth <i>Zone AE, AO, AH, VE, AR</i>
		Regulatory Floodway
OTHER AREAS OF FLOOD HAZARD		0.2% Annual Chance Flood Hazard, Areas of 1% annual chance flood with average depth less than one foot or with drainage areas of less than one square mile <i>Zone X</i>
		Future Conditions 1% Annual Chance Flood Hazard <i>Zone X</i>
		Area with Reduced Flood Risk due to Levee. See Notes. <i>Zone X</i>
		Area with Flood Risk due to Levee <i>Zone D</i>
OTHER AREAS		NO SCREEN Area of Minimal Flood Hazard <i>Zone X</i>
		Effective LOMRs
GENERAL STRUCTURES		Area of Undetermined Flood Hazard <i>Zone D</i>
		Channel, Culvert, or Storm Sewer
		Levee, Dike, or Floodwall
OTHER FEATURES		20.2 Cross Sections with 1% Annual Chance
		17.5 Water Surface Elevation
		Coastal Transect
		Base Flood Elevation Line (BFE)
		Limit of Study
MAP PANELS		Jurisdiction Boundary
		Coastal Transect Baseline
		Profile Baseline
		Hydrographic Feature
		Digital Data Available
		No Digital Data Available
		Unmapped



The pin displayed on the map is an approximate point selected by the user and does not represent an authoritative property location.

This map complies with FEMA's standards for the use of digital flood maps if it is not void as described below. The basemap shown complies with FEMA's basemap accuracy standards

The flood hazard information is derived directly from the authoritative NFHL web services provided by FEMA. This map was exported on **9/19/2023 at 10:24 AM** and does not reflect changes or amendments subsequent to this date and time. The NFHL and effective information may change or become superseded by new data over time.

This map image is void if the one or more of the following map elements do not appear: basemap imagery, flood zone labels, legend, scale bar, map creation date, community identifiers, FIRM panel number, and FIRM effective date. Map images for unmapped and unmodernized areas cannot be used for regulatory purposes.

APPENDIX F
INSPECTION & LONG TERM
MAINTENANCE PLAN

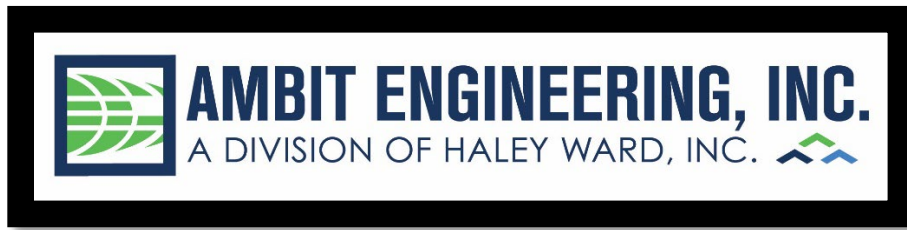

***INSPECTION & LONG-TERM MAINTENANCE PLAN
FOR
COMMERCIAL DEVELOPMENT***

**581 LAFAYETTE ROAD
PORTSMOUTH, NH**

Introduction

The intent of this plan is to provide the Atlas Commons, LLC (herein referred to as “owner”) with a list of procedures that document the inspection and maintenance requirements of the stormwater management system for this development. Specifically, the proposed Jellyfish® filter and associated drainage structures (collectively referred to as the “Stormwater Management System”). The contact information for the owner shall be kept current, and if there is a change of ownership of the property this plan must be transferred to the new owner.

The following inspection and maintenance program is necessary to keep the stormwater management system functioning properly and will help in maintaining a high quality of stormwater runoff to minimize potential environmental impacts. By following the enclosed procedures, the owner will be able to maintain the functional design of the stormwater management system and maximize its ability to remove sediment and other contaminants from site generated stormwater runoff.

Annual Report

The owner shall prepare an annual Inspection & Maintenance Report. The report shall include a summary of the system’s maintenance and repair by transmission of the Inspection & Maintenance Log and other information as required. A copy of the report shall be delivered annually to the Portsmouth DPW, if required.

Inspection & Maintenance Checklist/Log

The following pages contain the Stormwater Management System Inspection & Maintenance Requirements and a blank copy of the Stormwater Management System Inspection & Maintenance Log. These forms are provided to the owner as a guideline for performing the inspection and maintenance of the Stormwater Management System. This is a guideline and should be periodically reviewed for conformance with current practice and standards.

Stormwater Management System Components

The Stormwater Management System is designed to mitigate the quality of site-generated stormwater runoff. As a result, the design includes the following elements:

Non-Structural BMPs

Non-Structural best management practices (BMP's) include temporary and permanent measures that typically require less labor and capital inputs and are intended to provide protection against erosion of soils. Examples of non-structural BMP's on this project may include but are not limited to:

- Dust control
- Sediment barriers
- Stabilized construction entrance
- Catch basin basket

Structural BMPs

Structural BMPs are more labor and capital-intensive structures or installations that require more specialized personnel to install. Examples on this project include but are not limited to:

- Closed Drainage System
- Contech Jellyfish® Filter

Inspection and Maintenance Requirements

The following summarizes the inspection and maintenance requirements for the various BMP's that may be found on this project.

1. **Closed Drainage System:** Monitor accumulation of debris in drainage structures monthly or after significant rain events. Remove sediments when they accumulate within the outlet pipe. During construction, maintain inlet protection until all areas have been stabilized. Prior to the end of construction, inspect the drains and basins for accumulations and remove and clean by jet-vacuuming.
2. **Contech Jellyfish® Filter:** Refer to Manufacturer's instructions for procedure on maintenance of the unit.

Pollution Prevention

The following pollution prevention activities shall be undertaken to minimize potential impacts on stormwater runoff quality. The Contractor is responsible for all activities during construction. The Owner is responsible thereafter.

Spill Procedures

Any discharge of waste oil or other pollutant shall be reported immediately to the New Hampshire Department of Environmental Services (NHDES). The Contractor/Owner will be responsible for any incident of groundwater contamination resulting from the improper discharge of pollutants to the stormwater system and may be required by NHDES to remediate incidents that may impact groundwater quality. If the property ownership is transferred, the new owner will be informed of the legal responsibilities associated with operation of the stormwater system, as indicated above.

Sanitary Facilities

Sanitary facilities shall be provided during all phases of construction.

Material Storage

No on site trash facility is provided until homes are constructed. The contractors are required to remove trash from the site. Hazardous material storage is prohibited.

Material Disposal

All waste material, trash, sediment, and debris shall be removed from the site and disposed of in accordance with applicable local, state, and federal guidelines and regulations. Removed sediments shall be if necessary dewatered prior to disposal.

CATCH BASIN BASKET CONSTRUCTION MAINTENANCE SHEET

INSPECTION REQUIREMENTS		
ACTION TAKEN	FREQUENCY	MAINTENANCE REQUIREMENTS
-Check for damage to basket -Remove sediment from basket	Within 24 hours of rainfall, Daily during extended rainfall	-Repair basket as necessary to prevent particles from reaching drainage system, or to prevent flooding. -Empty basket after every storm, or if clogged.

MAINTENANCE LOG	
PROJECT NAME	
INSPECTOR NAME	INSPECTOR CONTACT INFO
DATE OF INSPECTION	REASON FOR INSPECTION <input type="checkbox"/> LARGE STORM EVENT <input type="checkbox"/> PERIODIC CHECK-IN
IS CORRECTIVE ACTION NEEDED? <input type="checkbox"/> YES <input type="checkbox"/> NO	DESCRIBE ANY PROBLEMS, NEEDED MAINTENANCE
DATE OF MAINTENANCE	PERFORMED BY
NOTES	

CLOSED DRAINAGE STRUCTURE LONG-TERM MAINTENANCE SHEET

INSPECTION REQUIREMENTS		
ACTION TAKEN	FREQUENCY	MAINTENANCE REQUIREMENTS
-Outlet Control Structures -Drain Manholes -Catch Basins	Every other Month	<i>Check for erosion or short-circuiting Check for sediment accumulation Check for floatable contaminants</i>
-Drainage Pipes	1 time per 2 years	<i>Check for sediment accumulation/clogging, or soiled runoff. Check for erosion at outlets.</i>

MAINTENANCE LOG	
PROJECT NAME	
INSPECTOR NAME	INSPECTOR CONTACT INFO
DATE OF INSPECTION	REASON FOR INSPECTION <input type="checkbox"/> LARGE STORM EVENT <input type="checkbox"/> PERIODIC CHECK-IN
IS CORRECTIVE ACTION NEEDED? <input type="checkbox"/> YES <input type="checkbox"/> NO	DESCRIBE ANY PROBLEMS, NEEDED MAINTENANCE
DATE OF MAINTENANCE	PERFORMED BY
NOTES	

STABILIZED CONSTRUCTION ENTRANCE CONSTRUCTION MAINTENANCE SHEET

INSPECTION REQUIREMENTS		
ACTION TAKEN	FREQUENCY	MAINTENANCE REQUIREMENTS
ENTRANCE SURFACE -Check for sediment accumulation/clogging of stone -Check Vegetative filter strips	After heavy rains, as necessary	-Top dress pad with new stone. -Replace stone completely if completely clogged. -Maintain vigorous stand of vegetation.
WASHING FACILITIES (if applicable) -Monitor Sediment Accumulation	As often as necessary	-Remove Sediments from traps.

MAINTENANCE LOG	
PROJECT NAME	
INSPECTOR NAME	INSPECTOR CONTACT INFO
DATE OF INSPECTION	REASON FOR INSPECTION <input type="checkbox"/> LARGE STORM EVENT <input type="checkbox"/> PERIODIC CHECK-IN
IS CORRECTIVE ACTION NEEDED? <input type="checkbox"/> YES <input type="checkbox"/> NO	DESCRIBE ANY PROBLEMS, NEEDED MAINTENANCE
DATE OF MAINTENANCE	PERFORMED BY
NOTES	

Jellyfish[®] Filter Maintenance Guide

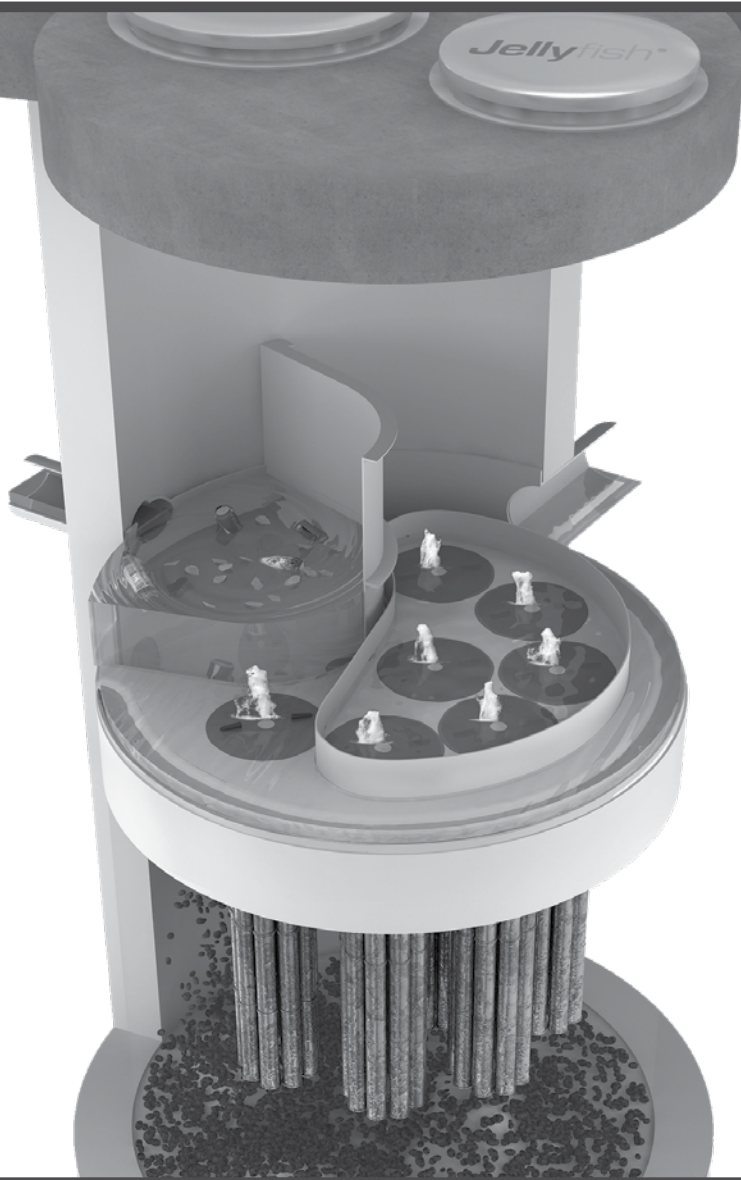



JELLYFISH® FILTER INSPECTION & MAINTENANCE GUIDE

Jellyfish units are often just one of many structures in a more comprehensive stormwater drainage and treatment system.

In order for maintenance of the Jellyfish filter to be successful, it is imperative that all other components be properly maintained. The maintenance and repair of upstream facilities should be carried out prior to Jellyfish maintenance activities.

In addition to considering upstream facilities, it is also important to correct any problems identified in the drainage area. Drainage area concerns may include: erosion problems, heavy oil loading, and discharges of inappropriate materials.

TABLE OF CONTENTS

Inspection and Maintenance Overview	3
Inspection Procedure.....	3
Maintenance Procedure.....	4
Cartridge Assembly & Cleaning.....	5
Inspection Process	7

1.0 Inspection and Maintenance Overview

The primary purpose of the Jellyfish® Filter is to capture and remove pollutants from stormwater runoff. As with any filtration system, these pollutants must be removed to maintain the filter's maximum treatment performance. Regular inspection and maintenance are required to insure proper functioning of the system.

Maintenance frequencies and requirements are site specific and vary depending on pollutant loading. Additional maintenance activities may be required in the event of non-storm event runoff, such as base-flow or seasonal flow, an upstream chemical spill or due to excessive sediment loading from site erosion or extreme runoff events. It is a good practice to inspect the system after major storm events.

Inspection activities are typically conducted from surface observations and include:

- Observe if standing water is present
- Observe if there is any physical damage to the deck or cartridge lids
- Observe the amount of debris in the Maintenance Access Wall (MAW) or inlet bay for vault systems

Maintenance activities include:

- Removal of oil, floatable trash and debris
- Removal of collected sediments
- Rinsing and re-installing the filter cartridges
- Replace filter cartridge tentacles, as needed

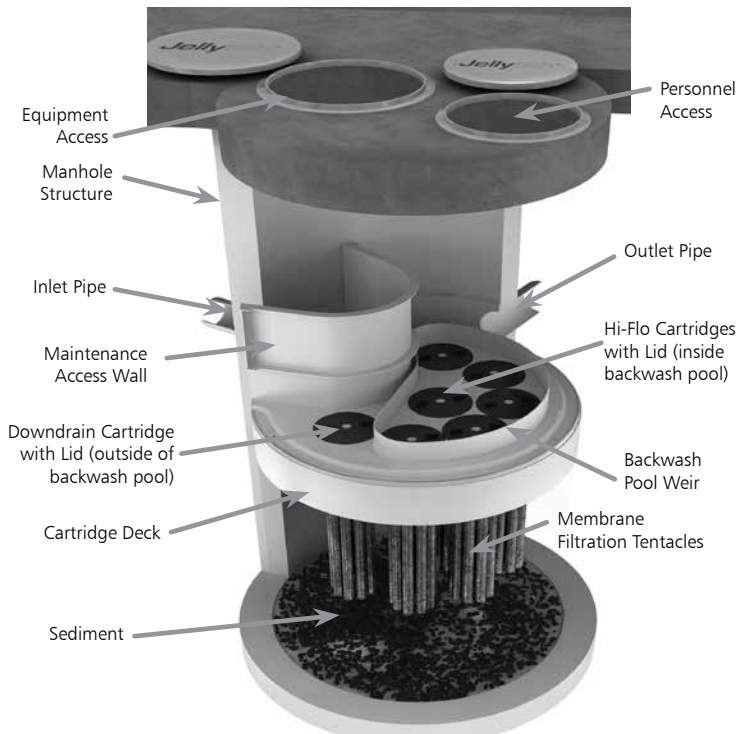

Note: Separator Skirt not shown

2.0 Inspection Timing

Inspection of the Jellyfish Filter is key in determining the maintenance requirements for, and to develop a history of, the site's pollutant loading characteristics. In general, inspections should be performed at the times indicated below; *or per the approved project stormwater quality documents (if applicable), whichever is more frequent.*

1. A minimum of quarterly inspections during the first year of operation to assess the sediment and floatable pollutant accumulation, and to ensure proper functioning of the system.
2. Inspection frequency in subsequent years is based on the inspection and maintenance plan developed in the first year of operation. Minimum frequency should be once per year.
3. Inspection is recommended after each major storm event.
4. Inspection is required immediately after an upstream oil, fuel or other chemical spill.

3.0 Inspection Procedure

The following procedure is recommended when performing inspections:

1. Provide traffic control measures as necessary.
2. Inspect the MAW or inlet bay for floatable pollutants such as trash, debris, and oil sheen.
3. Measure oil and sediment depth in several locations, by lowering a sediment probe until contact is made with the floor of the structure. Record sediment depth, and presences of any oil layers.
4. Inspect cartridge lids. Missing or damaged cartridge lids to be replaced.
5. Inspect the MAW (where appropriate), cartridge deck and receptacles, and backwash pool weir, for damaged or broken components.

3.1 Dry weather inspections

- Inspect the cartridge deck for standing water, and/or sediment on the deck.
- No standing water under normal operating conditions.
- Standing water inside the backwash pool, but not outside the backwash pool indicates, that the filter cartridges need to be rinsed.

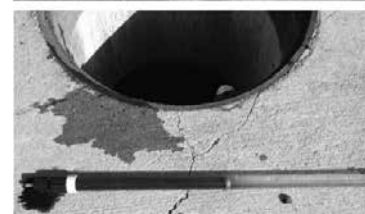

Inspection Utilizing Sediment Probe

- Standing water outside the backwash pool is not anticipated and may indicate a backwater condition caused by high water elevation in the receiving water body, or possibly a blockage in downstream infrastructure.
- Any appreciable sediment ($\geq 1/16''$) accumulated on the deck surface should be removed.

3.2 Wet weather inspections

- Observe the rate and movement of water in the unit. Note the depth of water above deck elevation within the MAW or inlet bay.
- Less than 6 inches, flow should be exiting the cartridge lids of each of the draindown cartridges (i.e. cartridges located outside the backwash pool).
- Greater than 6 inches, flow should be exiting the cartridge lids of each of the draindown cartridges and each of the hi-flo cartridges (i.e. cartridges located inside the backwash pool), and water should be overflowing the backwash pool weir.
- 18 inches or greater and relatively little flow is exiting the cartridge lids and outlet pipe, this condition indicates that the filter cartridges need to be rinsed.

4.0 Maintenance Requirements

Required maintenance for the Jellyfish Filter is based upon results of the most recent inspection, historical maintenance records, or the site specific water quality management plan; whichever is more frequent. In general, maintenance requires some combination of the following:

1. Sediment removal for depths reaching 12 inches or greater, or within 3 years of the most recent sediment cleaning, whichever occurs sooner.
2. Floatable trash, debris, and oil removal.
3. Deck cleaned and free from sediment.
4. Filter cartridges rinsed and re-installed as required by the most recent inspection results, or within 12 months of the most recent filter rinsing, whichever occurs sooner.
5. Replace tentacles if rinsing does not restore adequate hydraulic capacity, remove accumulated sediment, or if damaged or missing. It is recommended that tentacles should remain in service no longer than 5 years before replacement.
6. Damaged or missing cartridge deck components must be repaired or replaced as indicated by results of the most recent inspection.
7. The unit must be cleaned out and filter cartridges inspected immediately after an upstream oil, fuel, or chemical spill. Filter cartridge tentacles should be replaced if damaged or compromised by the spill.

5.0 Maintenance Procedure

The following procedures are recommended when maintaining the Jellyfish Filter:

1. Provide traffic control measures as necessary.
2. Open all covers and hatches. Use ventilation equipment as required, according to confined space entry procedures.
Caution: Dropping objects onto the cartridge deck may cause damage.

3. Perform Inspection Procedure prior to maintenance activity.
4. To access the cartridge deck for filter cartridge service, descend into the structure and step directly onto the deck. Caution: Do not step onto the maintenance access wall (MAW) or backwash pool weir, as damage may result. Note that the cartridge deck may be slippery.
5. Maximum weight of maintenance crew and equipment on the cartridge deck not to exceed 450 lbs.

5.1 Filter Cartridge Removal

1. Remove a cartridge lid.
2. Remove cartridges from the deck using the lifting loops in the cartridge head plate. Rope or a lifting device (available from Contech) should be used. **Caution: Should a snag occur, do not force the cartridge upward as damage to the tentacles may result. Wet cartridges typically weigh between 100 and 125 lbs.**
3. Replace and secure the cartridge lid on the exposed empty receptacle as a safety precaution. Contech does not recommend exposing more than one empty cartridge receptacle at a time.

5.2 Filter Cartridge Rinsing

1. Remove all 11 tentacles from the cartridge head plate. Take care not to lose or damage the O-ring seal as well as the plastic threaded nut and connector.



Cartridge Removal & Lifting Device



2. Position tentacles in a container (or over the MAW), with the threaded connector (open end) facing down, so rinse water is flushed through the membrane and captured in the container.
3. Using the Jellyfish rinse tool (available from Contech) or a low-pressure garden hose sprayer, direct water spray onto the tentacle membrane, sweeping from top to bottom along the length of the tentacle. Rinse until all sediment is removed from the membrane. **Caution: Do not use a high pressure sprayer or focused stream of water on the membrane. Excessive water pressure may damage the membrane.**

4. Collected rinse water is typically removed by vacuum hose.
5. Reassemble cartridges as detailed later in this document. Reuse O-rings and nuts, ensuring proper placement on each tentacle.

5.3 Sediment and Floatables Extraction

1. Perform vacuum cleaning of the Jellyfish Filter only after filter cartridges have been removed from the system. Access the lower chamber for vacuum cleaning only through the maintenance access wall (MAW) opening. Be careful not to damage the flexible plastic separator skirt that is attached to the underside of the deck on manhole systems. Do not lower the vacuum wand through a cartridge receptacle, as damage to the receptacle will result.
2. Vacuum floatable trash, debris, and oil, from the MAW opening or inlet bay. Alternatively, floatable solids may be removed by a net or skimmer.



Vacuuming Sump Through MAW

3. Pressure wash cartridge deck and receptacles to remove all sediment and debris. Sediment should be rinsed into the sump area. Take care not to flush rinse water into the outlet pipe.
4. Remove water from the sump area. Vacuum or pump equipment should only be introduced through the MAW or inlet bay.
5. Remove the sediment from the bottom of the unit through the MAW or inlet bay opening.



Vacuuming Sump Through MAW

6. For larger diameter Jellyfish Filter manholes (≥ 8 -ft) and some vaults complete sediment removal may be facilitated by removing a cartridge lid from an empty receptacle and inserting a jetting wand (not a vacuum wand) through the receptacle. Use the sprayer to rinse loosened sediment toward the vacuum hose in the MAW opening, being careful not to damage the receptacle.

5.4 Filter Cartridge Reinstallation and Replacement

1. Cartridges should be installed after the deck has been cleaned. It is important that the receptacle surfaces be free from grit and debris.
2. Remove cartridge lid from deck and carefully lower the filter cartridge into the receptacle until head plate gasket is seated squarely in receptacle. **Caution: Do not force the cartridge downward; damage may occur.**
3. Replace the cartridge lid and check to see that both male threads are properly seated before rotating approximately 1/3 of a full rotation until firmly seated. Use of an approved rim gasket lubricant may facilitate installation. See next page for additional details.
4. If rinsing is ineffective in removing sediment from the tentacles, or if tentacles are damaged, provisions must be made to replace the spent or damaged tentacles with new tentacles. Contact Contech to order replacement tentacles.

5.5 Chemical Spills

Caution: If a chemical spill has been captured, do not attempt maintenance. Immediately contact the local hazard response agency and contact Contech.

5.6 Material Disposal

The accumulated sediment found in stormwater treatment and conveyance systems must be handled and disposed of in accordance with regulatory protocols. It is possible for sediments to contain measurable concentrations of heavy metals and organic chemicals (such as pesticides and petroleum products). Areas with the greatest potential for high pollutant loading include industrial areas and heavily traveled roads. Sediments and water must be disposed of in accordance with all applicable waste disposal regulations. When scheduling maintenance, consideration must be made for the disposal of solid and liquid wastes. This typically requires coordination with a local landfill for solid waste disposal. For liquid waste disposal a number of options are available including a municipal vacuum truck decant facility, local waste water treatment plant or on-site treatment and discharge.

Jellyfish Filter Components & Filter Cartridge Assembly and Installation

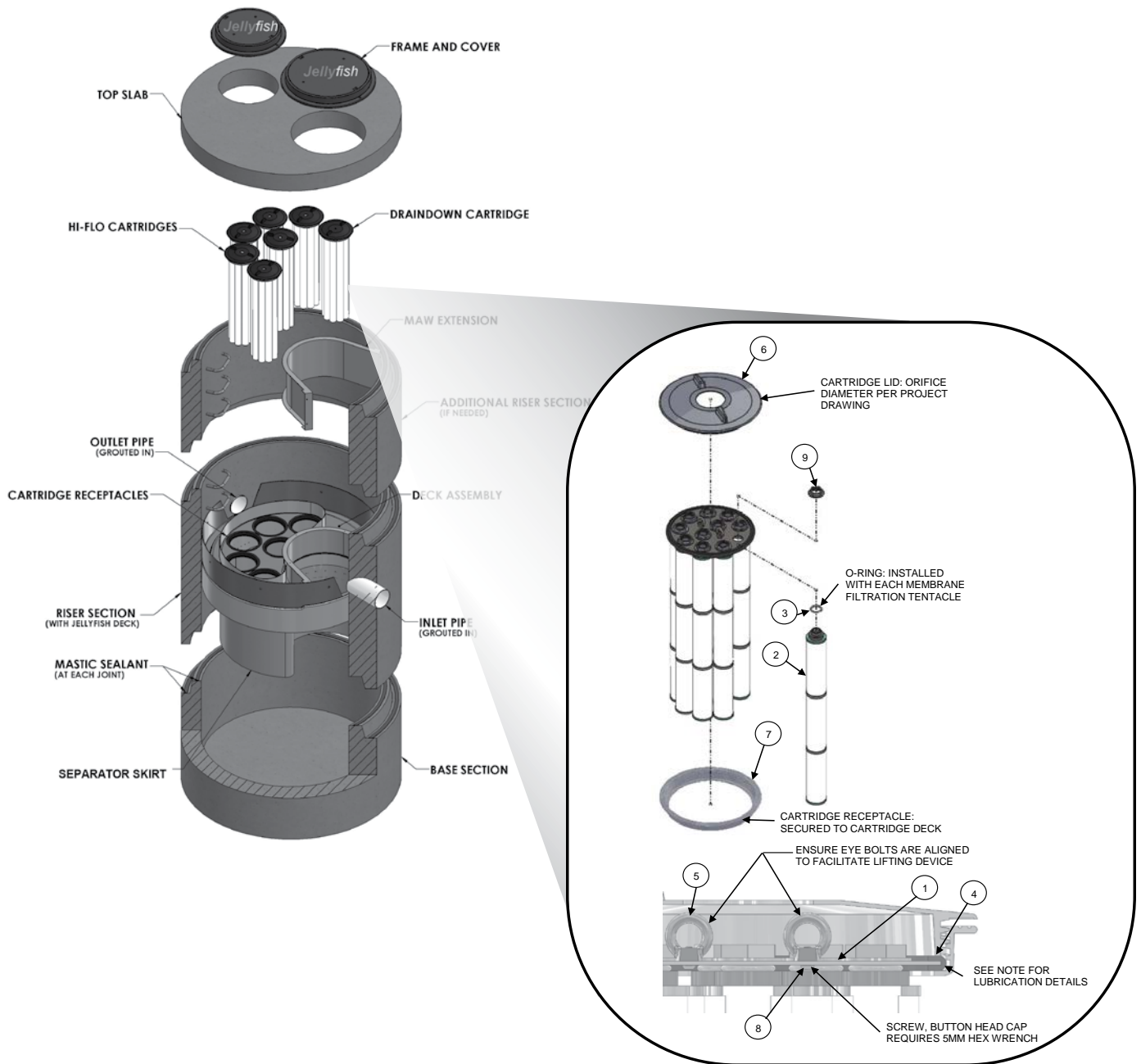

TABLE 1: BOM

ITEM NO.	DESCRIPTION
1	JF HEAD PLATE
2	JF TENTACLE
3	JF O-RING
4	JF HEAD PLATE GASKET
5	JF CARTRIDGE EYELET
6	JF 14IN COVER
7	JF RECEPTACLE
8	BUTTON HEAD CAP SCREW M6X14MM SS
9	JF CARTRIDGE NUT

TABLE 2: APPROVED GASKET LUBRICANTS

PART NO.	MFR	DESCRIPTION
78713	LA-CO	LUBRI-JOINT
40501	HERCULES	DUCK BUTTER
30600	OATEY	PIPE LUBRICANT
PSLUBXL1Q	PROSELECT	PIPE JOINT LUBRICANT

NOTES:

Head Plate Gasket Installation:

Install Head Plate Gasket (Item 4) onto the Head Plate (Item 1) and liberally apply a lubricant from Table 2: Approved Gasket Lubricants onto the gasket where it contacts the Receptacle (Item 7) and Cartridge Lids (Item 6). Follow Lubricant manufacturer's instructions.

Lid Assembly:

Rotate Cartridge Lid counter-clockwise until both male threads drop down and properly seat. Then rotate Cartridge Lid clockwise approximately one-third of a full rotation until Cartridge Lid is firmly secured, creating a watertight seal.

Jellyfish Filter Inspection and Maintenance Log

Owner:		Jellyfish Model No:	
Location:		GPS Coordinates:	
Land Use:	Commercial:	Industrial:	Service Station:
	Roadway/Highway:	Airport:	Residential:

Date/Time:						
Inspector:						
Maintenance Contractor:						
Visible Oil Present: (Y/N)						
Oil Quantity Removed:						
Floatable Debris Present: (Y/N)						
Floatable Debris Removed: (Y/N)						
Water Depth in Backwash Pool						
Draindown Cartridges externally rinsed and recommissioned: (Y/N)						
New tentacles put on Draindown Cartridges: (Y/N)						
Hi-Flo Cartridges externally rinsed and recommissioned: (Y/N)						
New tentacles put on Hi-Flo Cartridges: (Y/N)						
Sediment Depth Measured: (Y/N)						
Sediment Depth (inches or mm):						
Sediment Removed: (Y/N)						
Cartridge Lids intact: (Y/N)						
Observed Damage:						
Comments:						



Support

- Drawings and specifications are available at www.conteches.com/jellyfish.
- Site-specific design support is available from Contech Engineered Solutions.
- Find a Certified Maintenance Provider at www.conteches.com/ccmp

Jellyfish[®]

CONTECH[®]
ENGINEERED SOLUTIONS

800.338.1122

www.ContechES.com

© 2021 Contech Engineered Solutions LLC, a QUIKRETE Company

Contech Engineered Solutions LLC provides site solutions for the civil engineering industry. Contech's portfolio includes bridges, drainage, sanitary sewer, stormwater, wastewater treatment and earth stabilization products. For information on other Contech segment offerings, visit ContechES.com or call 800.338.1122

NOTHING IN THIS CATALOG SHOULD BE CONSTRUED AS A WARRANTY. APPLICATIONS SUGGESTED HEREIN ARE DESCRIBED ONLY TO HELP READERS MAKE THEIR OWN EVALUATIONS AND DECISIONS, AND ARE NEITHER GUARANTEES NOR WARRANTIES OF SUITABILITY FOR ANY APPLICATION. CONTECH MAKES NO WARRANTY WHATSOEVER, EXPRESS OR IMPLIED, RELATED TO THE APPLICATIONS, MATERIALS, COATINGS, OR PRODUCTS DISCUSSED HEREIN. ALL IMPLIED WARRANTIES OF MERCHANTABILITY AND ALL IMPLIED WARRANTIES OF FITNESS FOR ANY PARTICULAR PURPOSE ARE DISCLAIMED BY CONTECH. SEE CONTECH'S CONDITIONS OF SALE (AVAILABLE AT WWW.CONTECHES.COM/COS) FOR MORE INFORMATION.

MIXED USE DEVELOPMENT

581 LAFAYETTE ROAD PORTSMOUTH, NEW HAMPSHIRE SITE PERMIT PLANS

OWNER:

ATLAS COMMONS, LLC
3 PLEASANT STREET
SUITE #400
PORTSMOUTH, NH 03801

LAND SURVEYOR & CIVIL ENGINEER:

AMBIT ENGINEERING, INC.
A DIVISION OF HALEY WARD, INC
200 GRIFFIN ROAD, UNIT 3
PORTSMOUTH, N.H. 03801
Tel. (603) 430-9282
Fax (603) 436-2315

ARCHITECT:

ARCOVE ARCHITECTS
3 CONGRESS STREET, SUITE 1
PORTSMOUTH, NH 03801
TEL. (603) 988-0042

LANDSCAPE ARCHITECT:

TERRA FIRMA LANDSCAPE
ARCHITECTURE
163A COURT STREET
PORTSMOUTH, NH 03801
TEL. (603) 430-8388

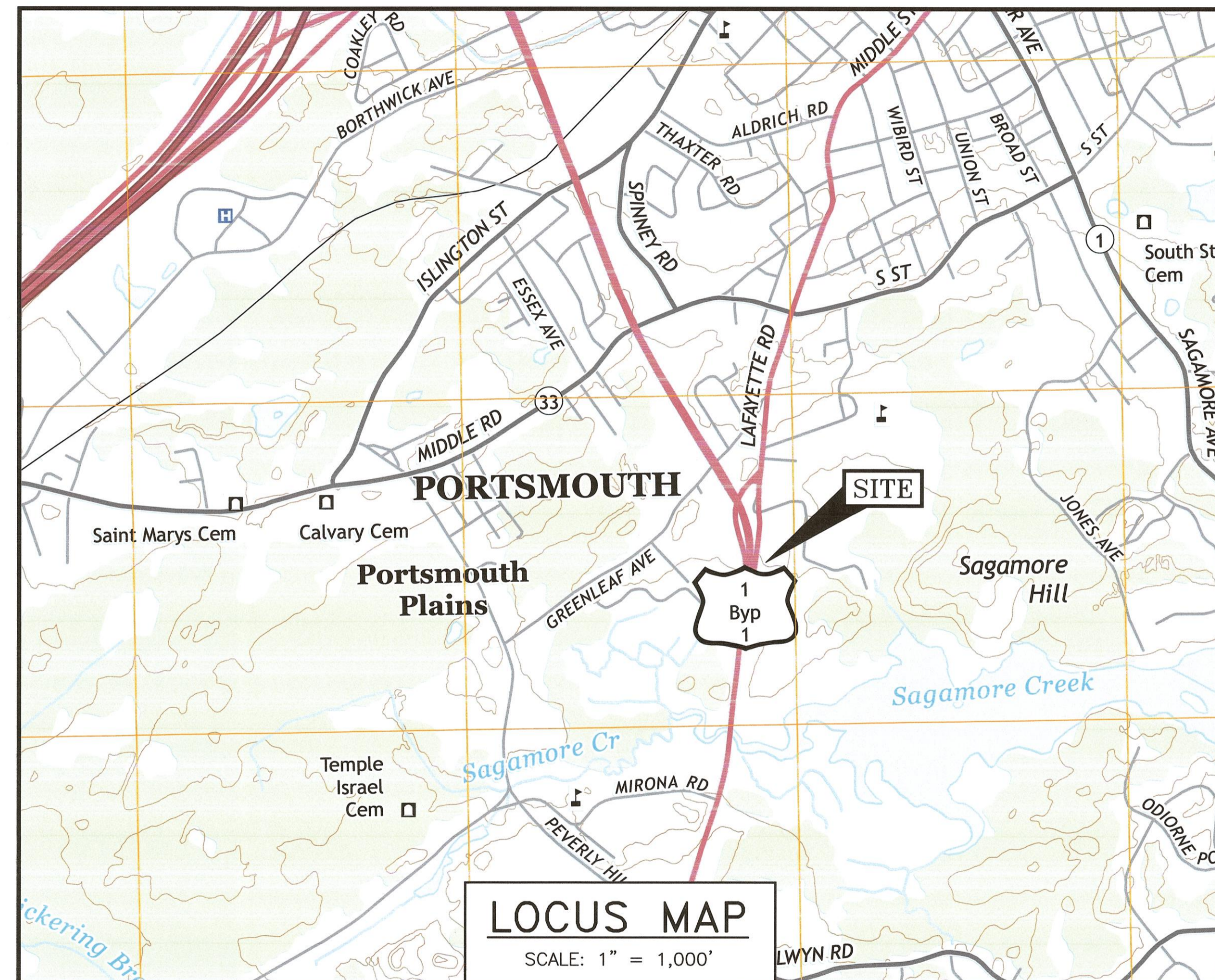
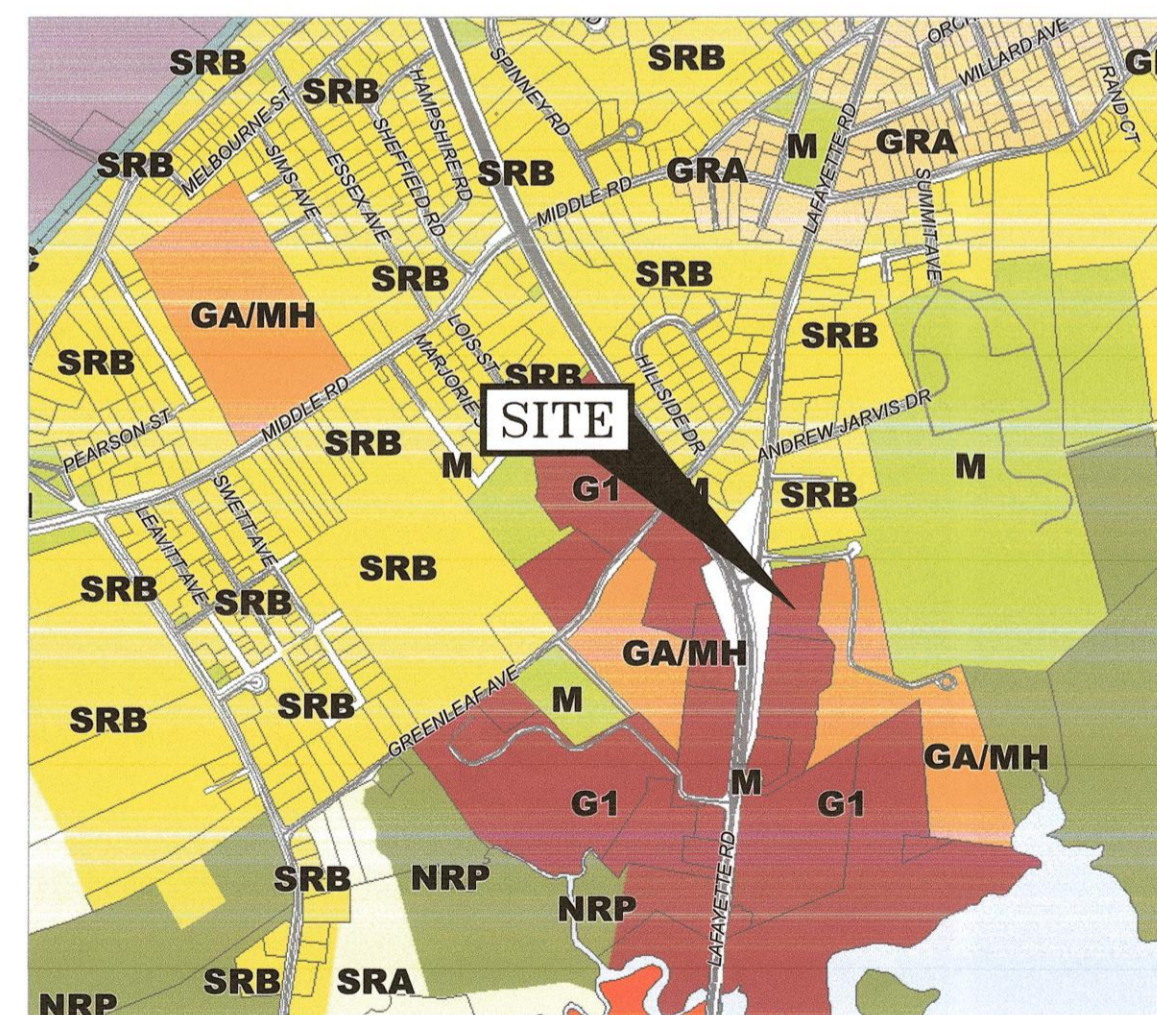

PERMIT LIST:

NHDES SEWER DISCHARGE PERMIT: TO BE SUBMITTED
PORTSMOUTH SITE PLAN APPROVAL: PENDING

LEGEND:

EXISTING	PROPOSED	
---	---	PROPERTY LINE
---	---	SETBACK
S	S	SEWER PIPE
SL	SL	SEWER LATERAL
G	G	GAS LINE
D	D	STORM DRAIN
W	W	WATER LINE
WS	WS	WATER SERVICE
UGE	UGE	UNDERGROUND ELECTRIC
OHW	OHW	OVERHEAD ELECTRIC/WIRES
---	---	FOUNDATION DRAIN
---	---	EDGE OF PAVEMENT (EP)
---	---	CONTOUR
---	---	SPOT ELEVATION
---	---	UTILITY POLE
---	---	WALL MOUNTED EXTERIOR LIGHTS
---	---	TRANSFORMER ON CONCRETE PAD
---	---	ELECTRIC HANDHOLD
---	---	SHUT OFFS (WATER/GAS)
---	---	GATE VALVE
---	---	HYDRANT
---	---	CATCH BASIN
---	---	SEWER MANHOLE
---	---	DRAIN MANHOLE
---	---	TELEPHONE MANHOLE
---	---	PARKING SPACE COUNT
---	---	PARKING METER
---	---	LANDSCAPED AREA
TBD	TBD	TO BE DETERMINED
CI	CI	CAST IRON PIPE
COP	COP	COPPER PIPE
DI	DI	DUCTILE IRON PIPE
PVC	PVC	POLYVINYL CHLORIDE PIPE
RCP	RCP	REINFORCED CONCRETE PIPE
AC	AC	ASBESTOS CEMENT PIPE
VC	VC	VITRIFIED CLAY PIPE
EP	EP	EDGE OF PAVEMENT
EL	EL	ELEVATION
FF	FF	FINISHED FLOOR
INV	INV	INVERT
S =	S =	SLOPE FT/FT
TBM	TBM	TEMPORARY BENCH MARK
TYP	TYP	TYPICAL

INDEX OF SHEETS

DWG No.	Description
-	COMMUNITY SPACE EASEMENT PLAN
C1	EXISTING CONDITIONS PLAN
C2	DEMOLITION PLAN
C3	SITE PLAN
L1 & L2	LANDSCAPE PLANS
L3	LIGHTING PLAN
C4	PARKING PLAN
C5	UTILITY PLAN
C6	GRADING, DRAINAGE, EROSION CONTROL PLAN
C7	OPEN SPACE PLAN
C8	COMMUNITY SPACE PLAN
C9	PUBLIC REALM PLAN
C10	PUBLIC REALM PLAN
C11	EXISTING AVERAGE GRADE PLANE
C12	PROPOSED AVERAGE GRADE PLANE
T1 & T2	TURNING PLANS
D1 - D6	EROSION CONTROL NOTES AND DETAILS
PB1.01-1.07	FLOOR PLANS
PB1.08-1.09	ELEVATIONS
PB1.10	RENDERINGS

UTILITY CONTACTS

ELECTRIC:
EVERSOURCE
1700 LAFAYETTE ROAD
PORTSMOUTH, N.H. 03801
Tel. (603) 436-7708, Ext. 555.5678
ATTN: MICHAEL BUSBY, P.E. (MANAGER)

NATURAL GAS:
UNILIT
325 WEST ROAD
PORTSMOUTH, N.H. 03801
Tel. (603) 294-5144
ATTN: DAVE BEAULIEU

CABLE:
COMCAST
155 COMMERCE WAY
PORTSMOUTH, N.H. 03801
Tel. (603) 679-5695 (X1037)
ATTN: MIKE COLLINS

SEWER & WATER:
PORTSMOUTH DEPARTMENT OF PUBLIC WORKS
680 PEVERLY HILL ROAD
PORTSMOUTH, N.H. 03801
Tel. (603) 427-1530
ATTN: JIM TOW

COMMUNICATIONS:
FAIRPOINT COMMUNICATIONS
JOE CONSIDINE
1575 GREENLAND ROAD
GREENLAND, N.H. 03840
Tel. (603) 427-5525

PORTSMOUTH APPROVAL CONDITIONS NOTE:
ALL CONDITIONS ON THIS PLAN SET SHALL REMAIN IN EFFECT IN
PERPETUITY PURSUANT TO THE REQUIREMENTS OF THE CITY OF
PORTSMOUTH SITE PLAN REVIEW REGULATIONS.

APPROVED BY THE PORTSMOUTH PLANNING BOARD

CHAIRMAN _____ DATE _____

SITE PLANS
MIXED USE DEVELOPMENT
581 LAFAYETTE ROAD
PORTSMOUTH, N.H.

AMBIT ENGINEERING, INC.
A DIVISION OF HALEY WARD, INC.

200 Griffin Road, Unit 3
Portsmouth, NH 03801
603.430.9282

WWW.HALEYWARD.COM

PLAN SET SUBMITTAL DATE: 24 JANUARY 2024

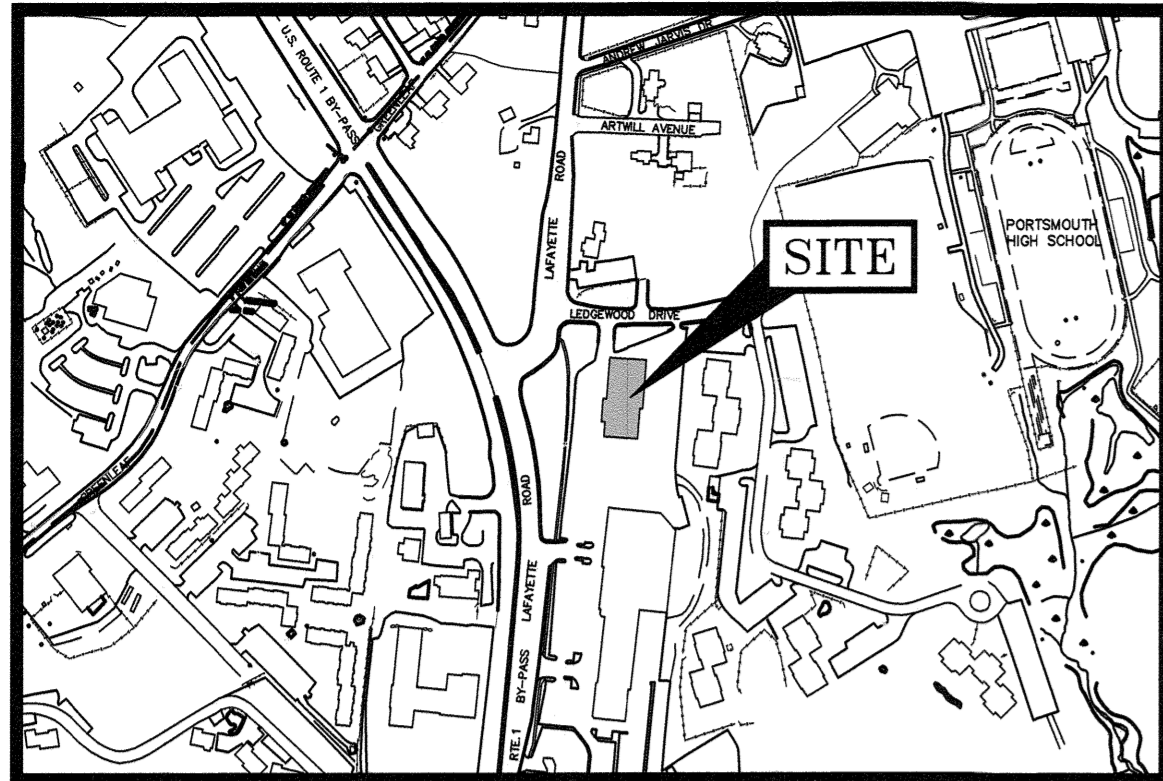

LAFAYETTE ROAD U.S. ROUTE 1

NEW HAMPSHIRE
STATE PLANE NAD 83

NOTES:

- 1) PARCEL IS SHOWN ON THE CITY OF PORTSMOUTH ASSESSOR'S MAP 229 AS LOT 8B.
- 2) OWNERS OF RECORD:
ATLAS COMMONS, LLC
3 PLEASANT STREET, SUITE 400
PORTSMOUTH, NH 03801
6474/1538
- 3) THE PARCEL IS NOT IN A FLOOD HAZARD ZONE AS SHOWN ON FIRM PANEL 3301500270F, EFFECTIVE JANUARY 29, 2021
- 4) EXISTING LOT AREA:
98,124 S.F.
2.2526 AC
- 5) PARCEL IS LOCATED IN THE GATEWAY NEIGHBORHOOD CORRIDOR (G1) DISTRICT.
- 6) DIMENSIONAL REQUIREMENTS:
SEE ZONING ORDINANCE SECTION 10.5B22.10
- 7) THE PURPOSE OF THIS PLAN IS TO SHOW THE COMMUNITY SPACE EASEMENT ON TAX MAP 229 LOT 8B.

LOCATION MAP SCALE: 1" = 400'±

LENGTH TABLE

LINE	BEARING	DISTANCE
L1	S15°17'27"W	14.20'
L2	S48°43'16"E	33.26'

COMMUNITY SPACE

- 1,051 S.F. OF WIDE PEDESTRIAN SIDEWALK 1
- 7,395 S.F. OF WIDE PEDESTRIAN SIDEWALK 2
- 1,400 S.F. OF OUTDOOR DINING CAFE
- PROPOSED COMMUNITY SPACE 9,846 S.F.
LOT AREA 98,124 S.F.
- COMMUNITY SPACE REQUIRED: 10%
(PER SECTION 10.5B41.80.2)
- COMMUNITY SPACE PROVIDED: 10.0%
- COMMUNITY SPACE USES
(PER SECTION 10.5B102)
- PROPOSED USES: COURTYARD
WIDE PEDESTRIAN SIDEWALK

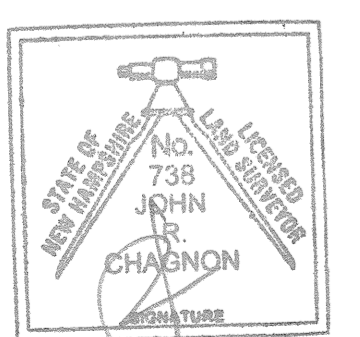
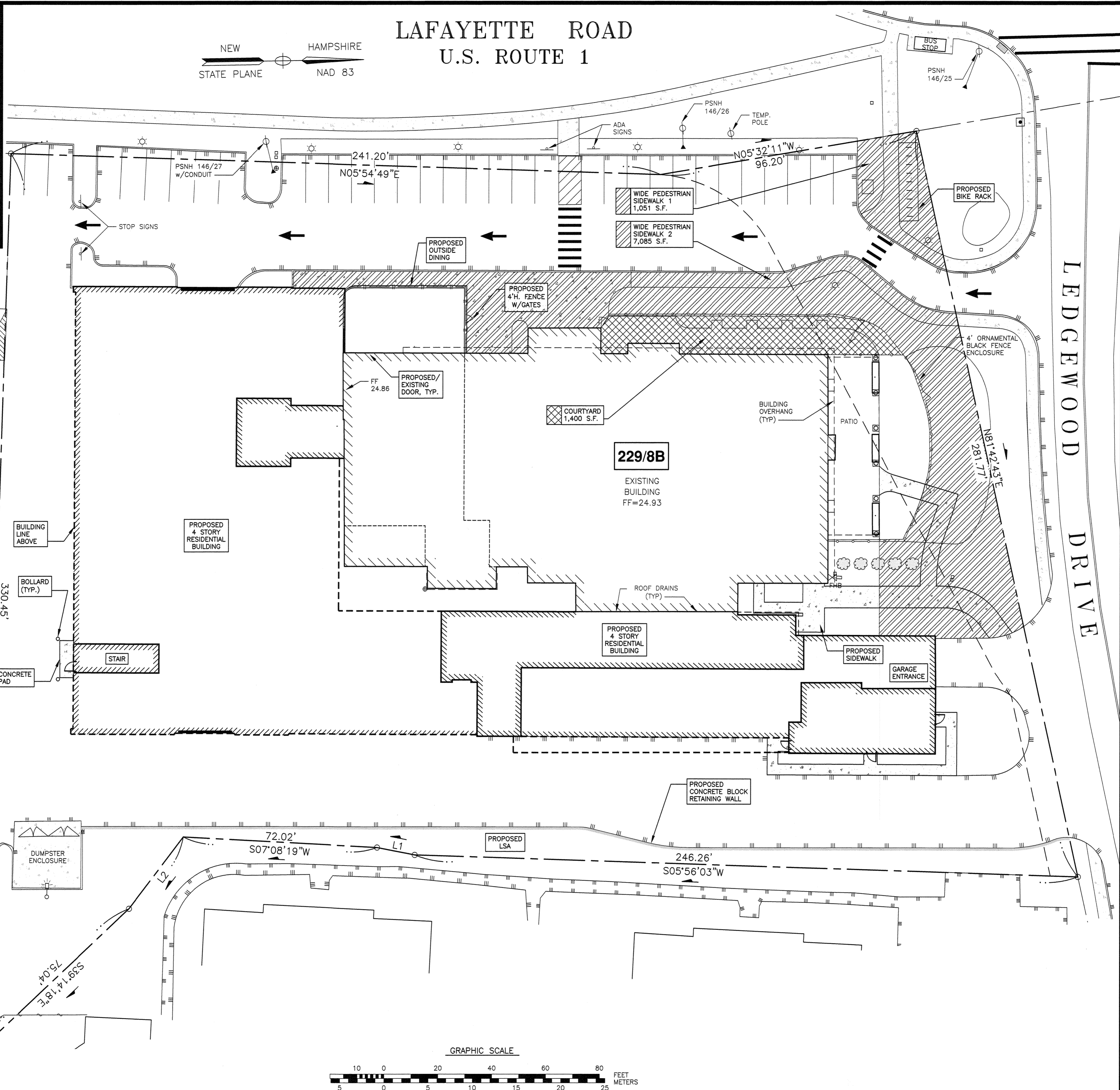

I CERTIFY THAT THIS PLAN WAS PREPARED UNDER MY DIRECT SUPERVISION, THAT IT IS THE RESULT OF A FIELD SURVEY BY THIS OFFICE AND HAS AN ACCURACY OF THE CLOSED TRAVERSE THAT EXCEEDS THE PRECISION OF 1:15,000.

I CERTIFY THAT THIS SURVEY PLAT IS NOT A SUBDIVISION PURSUANT TO THIS TITLE AND THAT THE LINES OF STREETS AND WAYS SHOWN ARE THOSE OF PUBLIC OR PRIVATE STREETS OR WAYS ALREADY ESTABLISHED AND THAT NO NEW WAYS ARE SHOWN.

John R. Chagnon
JOHN R. CHAGNON, LLS 73B
DATE 1-24-24

GRAPHIC SCALE

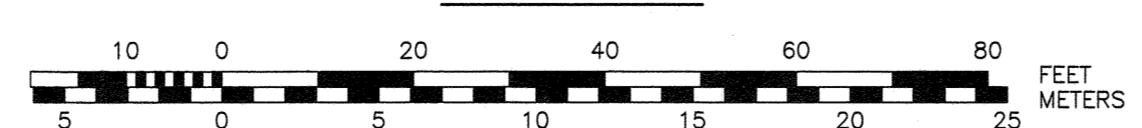

NO.	DESCRIPTION	DATE
0	ISSUED FOR COMMENT	1/24/24
REVISIONS		

**581 LAFAYETTE ROAD
COMMUNITY SPACE
EASEMENT PLAN
TAX MAP 229 - LOT 8B
TO
THE CITY OF PORTSMOUTH
OWNER
ATLAS COMMONS, LLC**

PROPERTY LOCATED AT
581 LAFAYETTE ROAD
CITY OF PORTSMOUTH
COUNTY OF ROCKINGHAM
STATE OF NEW HAMPSHIRE

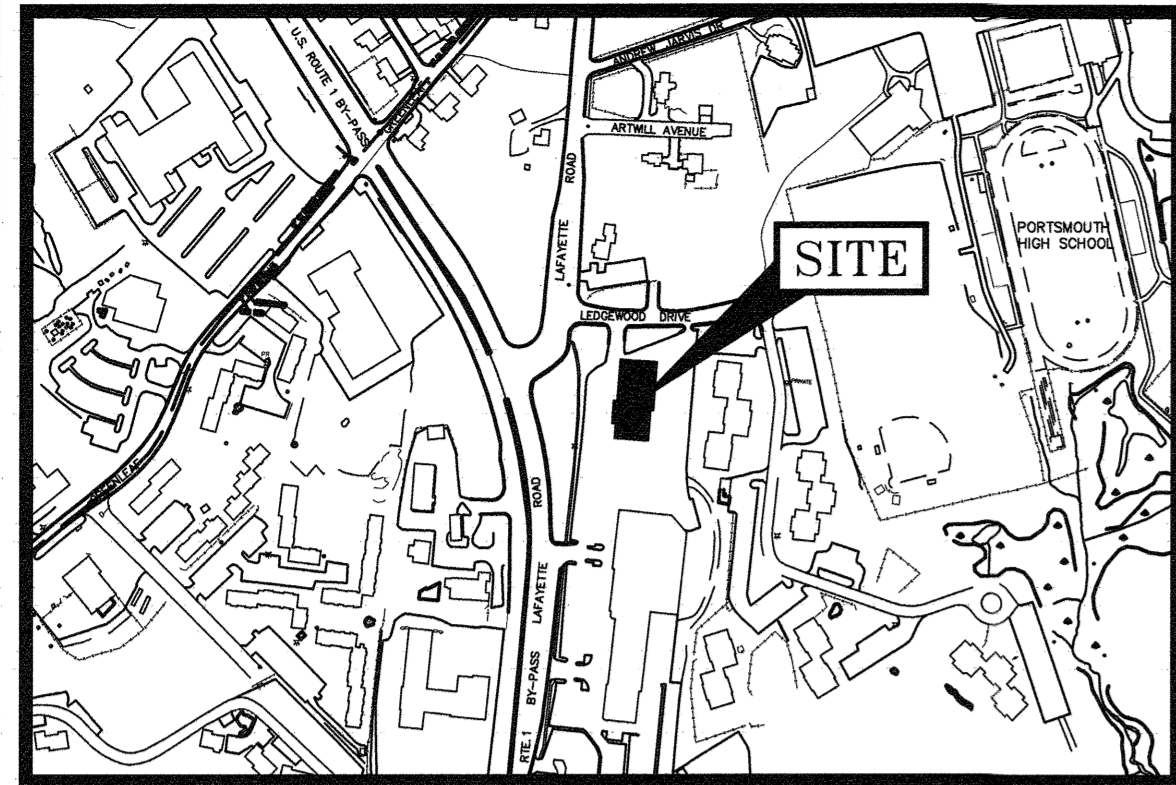

LOCATION MAP

SCALE: 1" = 400'±

LENGTH TABLE

LINE	BEARING	DISTANCE
L1	S15°17'27"W	14.20'
L2	S48°43'16"E	33.26'

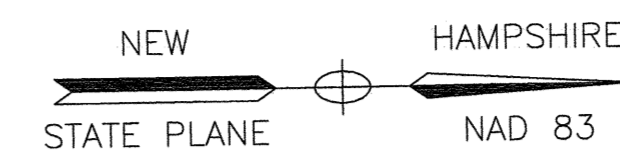

LAFAYETTE ROAD
U.S. ROUTE 1

LEGEND

EXISTING	DESCRIPTION
124/21	MAP 124 / LOT 21
N/F	NOW OR FORMERLY
RP	RECORD OF PROBATE
RCRD	ROCKINGHAM COUNTY REGISTRY OF DEEDS
	BOUNDARY LINE
	SETBACK LINE
RR SPK FND	RAILROAD SPIKE FOUND
IR FND	IRON ROD FOUND
IP FND	IRON PIPE FOUND
DH FND	DRILL HOLE FOUND
BND w/ DH	BOUND w/ DRILL HOLE
FM	FORCE MAIN
S	SEWER LINE
G	GAS LINE
D	STORM DRAIN
W	POTABLE WATER LINE
	UNDERGROUND ELECTRIC
	OVERHEAD WIRES
100	CONTOUR LINE
97x3	SPOT ELEVATION
	EDGE OF PAVEMENT
	WOODS / TREE LINE
	UTILITY POLE (w/ GUY) (w/ LIGHT)
	LIGHT POLE
	SHUTOFF/CURB STOP (WATER, GAS, SEWER)
	GATE VALVE
HYD.	HYDRANT
CB	CATCH BASIN
TM	TELEPHONE MANHOLE
SM	SEWER MANHOLE
DM	DRAIN MANHOLE
FF	FINISHED FLOOR
INV.	INVERT
TBM	TEMPORARY BENCHMARK
TYP.	TYPICAL

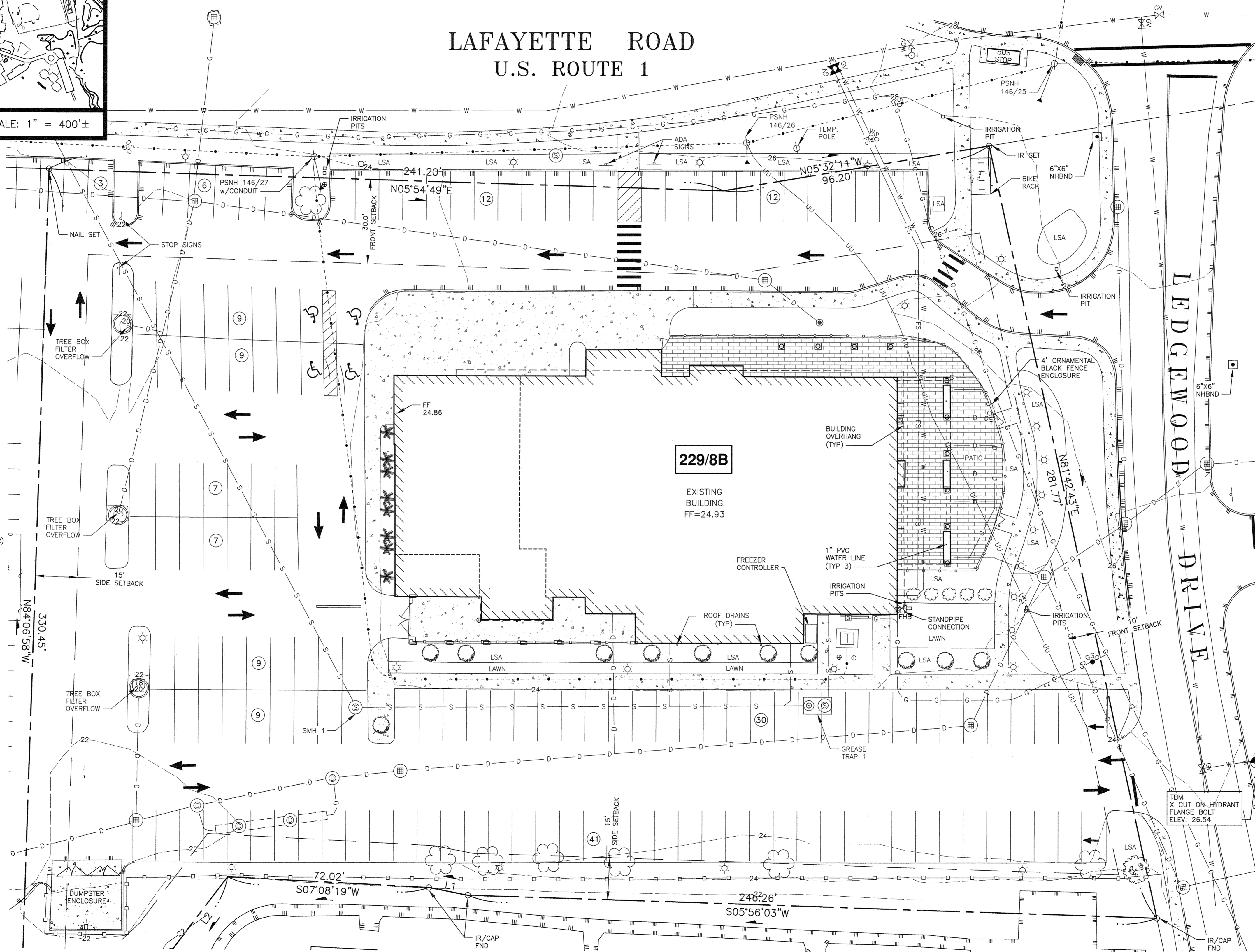

GRAPHIC SCALE

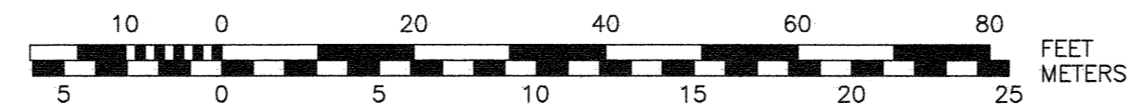

200 Griffin Road, Unit 3
Portsmouth, NH 03801
603.430.9282

WWW.HALEYWARD.COM

NOTES:

- 1) PARCEL IS SHOWN ON THE CITY OF PORTSMOUTH ASSESSOR'S MAP 229 AS LOT 8B.
- 2) OWNERS OF RECORD:
ATLAS COMMONS, LLC
3 PLEASANT STREET, SUITE 400
PORTSMOUTH, NH 03801
6474/1538
- 3) THE PARCEL IS NOT IN A FLOOD HAZARD ZONE AS SHOWN ON FIRM PANEL 33015C0270F, EFFECTIVE JANUARY 29, 2021.
- 4) EXISTING LOT AREA:
98,124 S.F.
2,2526 AC
- 5) PARCEL IS LOCATED IN THE GATEWAY (GW) DISTRICT.
- 6) DIMENSIONAL REQUIREMENTS:
SEE ZONING ORDINANCE SECTION 10.5B22.10
- 7) THE PURPOSE OF THIS PLAN IS TO SHOW THE EXISTING CONDITIONS ON TAX MAP 229 LOT 8B.
- 8) EASEMENTS & RESTRICTIONS:
A) ROAD/UTILITY EASEMENT AREA: SEE C-3316 AND RCRD 2110/428 AND 2184/184. THIS EASEMENT WAS PARTIALLY TERMINATED ON 11/9/15; SEE RCRD 5669/0645.
B) 30' RIGHT OF WAY: SEE D-8806 AND 5446/2589.
C) MUTUAL PARKING AND ACCESS RIGHTS FOR LOTS 1-3 ON PLAN D-8806 ARE OF RECORD. RCRD 2343/128 AND 5446/2588.
- 9) UNDERGROUND UTILITY LOCATIONS ARE BASED UPON BEST AVAILABLE EVIDENCE AND ARE NOT FIELD VERIFIED. LOCATING AND PROTECTING ANY ABOVEGROUND OR UNDERGROUND UTILITIES IS THE SOLE RESPONSIBILITY OF THE CONTRACTOR AND/OR THE OWNER. UTILITY CONFLICTS SHOULD BE REPORTED AT ONCE TO THE DESIGN ENGINEER.
- 10) THE 2011 NHDOT LAFAYETTE ROAD PROJECT IDENTIFIED THIS ENCROACHMENT.

COMMERCIAL DEVELOPMENT
581 LAFAYETTE ROAD
PORTSMOUTH, N.H.

NO.	DESCRIPTION	DATE
2	CONTOURS, NOTE 6	1/24/24
1	ISSUED FOR APPROVAL	9/5/23
0	ISSUED FOR COMMENT	7/5/23

REVISIONS

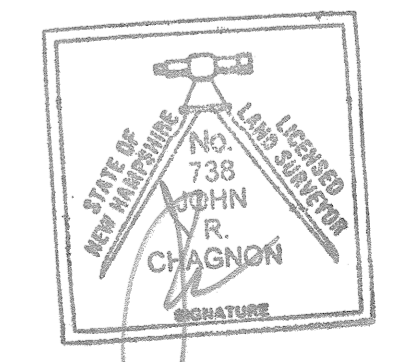

SCALE: 1"=20'

JULY 2023

EXISTING CONDITIONS PLAN

C1

GENERAL NOTES:

- 1) THE CONTRACTOR SHALL NOTIFY DIG SAFE AT 1-888-DIG-SAFE (1-888-344-7233) AT LEAST 72 HOURS PRIOR TO COMMENCING ANY EXCAVATION ON PUBLIC OR PRIVATE PROPERTY WITHIN 100 FEET OF UNDERGROUND UTILITIES. THE EXCAVATOR IS RESPONSIBLE TO MAINTAIN MARKS. DIG SAFE TICKETS EXPIRE IN THIRTY DAYS.
- 2) UNDERGROUND UTILITY LOCATIONS ARE BASED UPON BEST AVAILABLE EVIDENCE AND ARE NOT FIELD VERIFIED. LOCATING AND PROTECTING ANY ABOVEGROUND OR UNDERGROUND UTILITIES IS THE SOLE RESPONSIBILITY OF THE CONTRACTOR AND/OR THE OWNER. UTILITY CONFLICTS SHOULD BE REPORTED AT ONCE TO THE DESIGN ENGINEER.
- 3) CONTRACTOR SHALL INSTALL AND MAINTAIN EROSION CONTROL MEASURES IN ACCORDANCE WITH THE "NEW HAMPSHIRE STORMWATER MANUAL, VOLUME 3, EROSION AND SEDIMENT CONTROLS DURING CONSTRUCTION. (NHDES DECEMBER 2008).

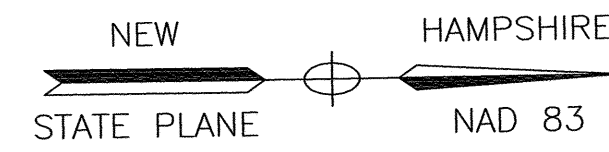

DEMOLITION NOTES

- A) THE LOCATIONS OF UNDERGROUND UTILITIES ARE APPROXIMATE AND THE LOCATIONS ARE NOT GUARANTEED BY THE OWNER OR THE DESIGNER. IT IS THE CONTRACTOR'S RESPONSIBILITY TO LOCATE UTILITIES AND ANTICIPATE CONFLICTS. CONTRACTOR SHALL REPAIR EXISTING UTILITIES DAMAGED BY THEIR WORK AND RELOCATE EXISTING UTILITIES THAT ARE REQUIRED TO BE RELOCATED PRIOR TO COMMENCING ANY WORK IN THE IMPACTED AREA OF THE PROJECT.
- B) ALL MATERIALS SCHEDULED TO BE REMOVED SHALL BECOME THE PROPERTY OF THE CONTRACTORS UNLESS OTHERWISE SPECIFIED. THE CONTRACTOR SHALL DISPOSE OF ALL MATERIALS OFF-SITE IN ACCORDANCE WITH ALL FEDERAL, STATE, AND LOCAL REGULATIONS, ORDINANCES AND CODES. THE CONTRACTOR SHALL COORDINATE REMOVAL, RELOCATION, DISPOSAL, OR SALVAGE OF UTILITIES WITH THE OWNER AND APPROPRIATE UTILITY COMPANY.
- C) ANY EXISTING WORK OR PROPERTY DAMAGED OR DISRUPTED BY CONSTRUCTION/ DEMOLITION ACTIVITIES SHALL BE REPLACED OR REPAIRED TO THE ORIGINAL EXISTING CONDITIONS BY THE CONTRACTOR AT NO ADDITIONAL COST TO THE OWNER.
- D) THE CONTRACTOR SHALL VERIFY LOCATION OF ALL EXISTING UTILITIES AND CALL DIG SAFE AT LEAST 72 HOURS PRIOR TO THE COMMENCEMENT OF ANY DEMOLITION/CONSTRUCTION ACTIVITIES.
- E) SAWCUT AND REMOVE PAVEMENT ONE FOOT OFF PROPOSED EDGE OF PAVEMENT TRENCH IN AREAS WHERE PAVEMENT IS TO BE REMOVED.
- F) IT IS THE CONTRACTOR'S RESPONSIBILITY TO FAMILIARIZE THEMSELVES WITH THE CONDITIONS OF ALL THE PERMIT APPROVALS.
- G) THE CONTRACTOR SHALL OBTAIN AND PAY FOR ADDITIONAL CONSTRUCTION PERMITS, NOTICES AND FEES NECESSARY TO COMPLETE THE WORK AND ARRANGE FOR AND PAY FOR ANY INSPECTIONS AND APPROVALS FROM THE AUTHORITIES HAVING JURISDICTION. THE CONTRACTOR SHALL BE RESPONSIBLE FOR ANY ADDITIONAL AND OFF-SITE DISPOSAL OF MATERIALS REQUIRED TO COMPLETE THE WORK.
- H) THE CONTRACTOR SHALL REMOVE AND DISPOSE OF ALL EXISTING STRUCTURES, CONCRETE, UTILITIES, VEGETATION, PAVEMENT, AND CONTAMINATED SOIL WITHIN THE WORK LIMITS SHOWN UNLESS SPECIFICALLY IDENTIFIED TO REMAIN. ANY EXISTING DOMESTIC / IRRIGATION SERVICE WELLS IN THE PROJECT AREA IDENTIFIED DURING THE CONSTRUCTION AND NOT CALLED OUT ON THE PLANS SHALL BE BROUGHT TO THE ATTENTION OF THE OWNER AND ENGINEER FOR PROPER CAPPING / RE-USE.
- I) PROVIDE INLET PROTECTION BARRIERS AT ALL CATCH BASINS WITHIN CONSTRUCTION LIMITS AND MAINTAIN FOR THE DURATION OF THE PROJECT. INLET PROTECTION BARRIERS SHALL BE HIGH FLOW SILT SOCK BY ACF ENVIRONMENTAL OR APPROVED EQUAL. INSPECT BARRIERS WEEKLY AND AFTER EACH RAIN OF 0.25 INCHES OR GREATER. CONTRACTOR SHALL COMPLETE A MAINTENANCE INSPECTION REPORT AFTER EACH INSPECTION. SEDIMENT DEPOSITS SHALL BE REMOVED AFTER EACH STORM EVENT OR MORE OFTEN IF WARRANTED OR FABRIC BECOMES CLOGGED. EROSION CONTROL MEASURES SHALL BE INSTALLED PRIOR TO THE START OF ANY CLEARING OR DEMOLITION ACTIVITIES.
- J) THE CONTRACTOR SHALL PAY ALL COSTS NECESSARY FOR TEMPORARY PARTITIONING, BARRICADING, FENCING, SECURITY AND SAFETY DEVICES REQUIRED FOR THE MAINTENANCE OF A CLEAN AND SAFE CONSTRUCTION SITE.
- K) ANY CONTAMINATED MATERIAL REMOVED DURING THE COURSE OF THE WORK WILL REQUIRE HANDLING IN ACCORDANCE WITH NHDES REGULATIONS. CONTRACTOR SHALL HAVE A HEALTH AND SAFETY PLAN IN PLACE, AND COMPLY WITH ALL APPLICABLE PERMITS, APPROVALS, AUTHORIZATIONS, AND REGULATIONS.

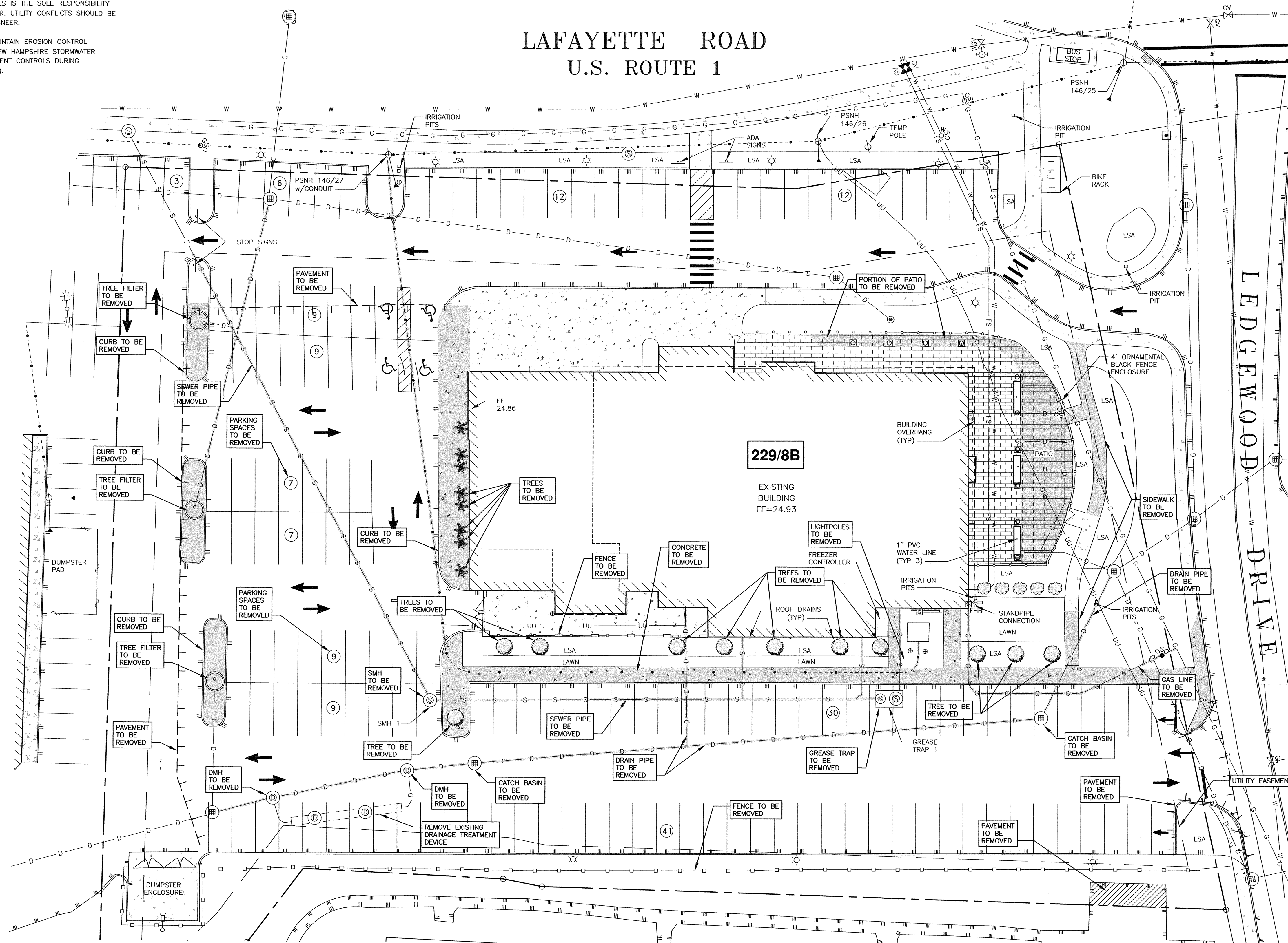

COMMERCIAL DEVELOPMENT
581 LAFAYETTE ROAD
PORTSMOUTH, N.H.

NO.	DESCRIPTION	DATE
1	ISSUED FOR APPROVAL	9/5/23
0	ISSUED FOR COMMENT	7/5/23

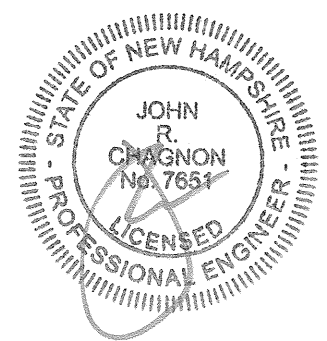

SCALE: 1"=20' JULY 2023

DEMOLITION PLAN **C2**

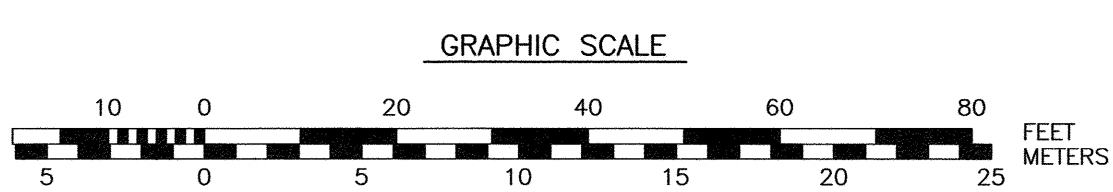

ZONING TABLE

Zone	additions	proposed
G1 allowed		
Height	G1 apartments: 5 stories or 60 ft. per Density Bonus 10.5872.30: 4 stories or 50 ft. (+ density bonus 1 story or 10') 10.58.22.20, at streets <40' row: 35' max <45' setback 45' max <50' setback 60' max >50' setback.	<37' /3 stories at street fronts <45' /4 stories beyond <50' /5 stories at center: Building A: 56'-9 13/16" Building B: 57'-8 1/16"
Penthouses	10' above allowed building height	<10'
Roof appurtenance	Roof decks, roof gardens, and related structures and appurtenances shall not be counted in the building height limits.	<10'
Façade Types	forecourt, recessed entry, dooryard, step, porch	recessed entry Workforce Housing: 4 stories Podium parking at street level and one level below grade.
Building Types	Dwelling units	
Setbacks (ft) *		
Front (principle)	70'-90' from cl of Lafayette Rd	setback is within public way
Front (secondary)	min 10' & max 30' from Lot Line at Ledgewood	33'
Side	Minimum side setback: 15 ft. Where a development site includes a more than one building type, the minimum building setback to interior lot lines shall be 0 feet.	39'
Rear	N/A Minimum rear setback: 20 ft. (& 25 ROW easement)	23.6'
Front lot line buildout residential	50%	85%
Front lot line buildout commercial/mixed-use	75%	85%
Frontage, Lafayette	100 ft min	337.4'
Lot area (sf)	NR	
Workforce Housing units for rent: min 10% or 2 units, min. 800 sf or average unit size (larger of two)	WF units are larger than average unit size, >859 sf	
Coverage, maximum	50%	82.4%
Footprint, max	NR for apartment buildings	
For developments located on public transit with year-round, 5-days-per-week, fixed-route service and where at least 50% of the building(s) are within 1/4 mile of a transit stop, the minimum offstreet parking shall be reduced by 20%.		See attached parking summary
Offstreet parking		
ground floor area per use, max	NR	parking
Open space, minimum	20%	17.6%
permitted uses (G1)	multifamily, restaurant	multifamily
building length, max (ft)	200	<200
façade modulation length, max (ft)	A) Symmetrical and vertically articulated bays >6' & <50' wide, minimum 3.	
	B) Buildings greater than one hundred (100) feet in width shall read as a series of smaller buildings with varied architectural design and façade glazing patterns; or include a change in vertical plane of the façade of at least four (4) feet (in depth or projection) for at least one (1) bay in width for every one hundred (100) feet of total façade width. This change in plane applies to the entire height of the façade.	modulations < 100 ft
entrance spacing, max (ft)		both entries are facing street fronts
floor height above sidewalk, max	36"	8"
ground floor height, min		12'
second floor height, min		11'
glazing, shopfront, min	20%	entrances 100%. Sides & rear: podium parking at first floor, some open and some screening
glazing, other	NR	
roof types (pitch)	structural expression of the building façade and its materials	Flat & Sloped
Parking, off-street:	1 bicycle space for each 5 dwellings units or portion thereof. Off-site parking: Less than 500 sq. ft. 0.5 spaces per unit. 500-700 sq. ft. 1.0 space per unit. Over 750 sq. ft. 1.3 space per unit. 10.1112.312 In addition to the off-street parking spaces provided in accordance with Sec. 10.1112.311, any dwelling or group of dwelling on a lot containing more than 4 dwelling units shall provide one visitor parking space for every 5 dwelling units or portion thereof.	See attached parking summary
Units density	24 units per building. 36 units exception for workforce housing Conditional Use Permit under the provisions for Density Bonuses in Section 10.5872.10.5872	36 units per building * 2 buildings = 72 units

IMPERVIOUS SURFACE AREAS (TO PROPERTY LINE)

STRUCTURE	POST-CONSTRUCTION IMPERVIOUS (S.F.)
MAIN STRUCTURE	43567
CONCRETE/SIDEWALK	5,722
PAVEMENT	30,945
CURB	249
RETAINING WALL	368
TOTAL	80851
LOT SIZE	98,124
% LOT COVERAGE	82.4%

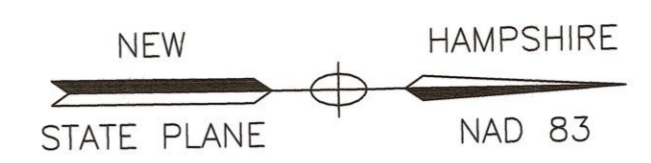

LAFAYETTE ROAD
U.S. ROUTE 1

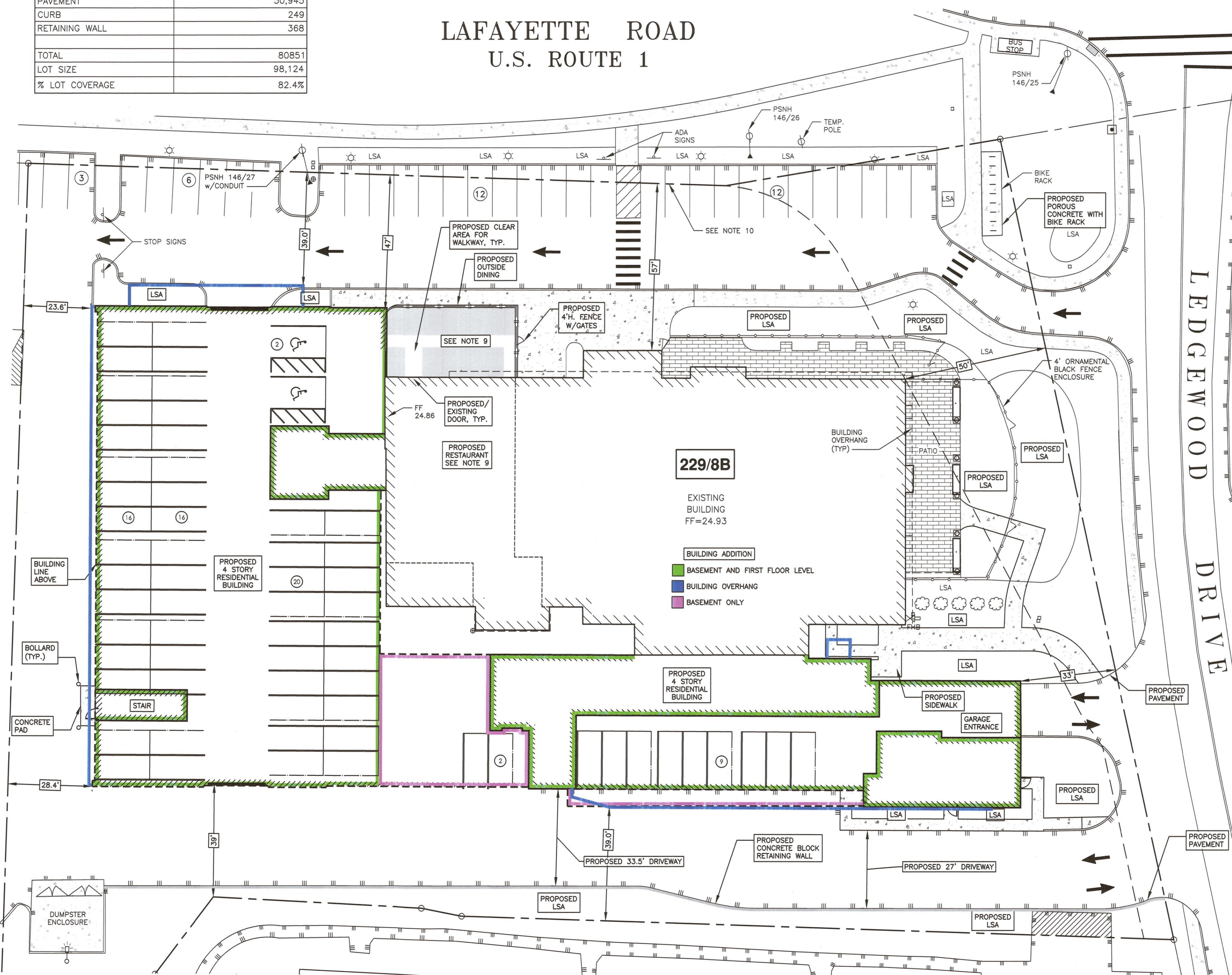

229/8B

EXISTING BUILDING
FF=24.93

- BUILDING ADDITION
- BASEMENT AND FIRST FLOOR LEVEL
- BUILDING OVERHANG
- BASEMENT ONLY

GRAPHIC SCALE

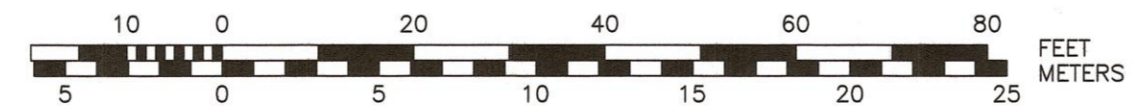

AMBIT ENGINEERING, INC.
A DIVISION OF HALEY WARD, INC.

200 Griffin Road, Unit 3
Portsmouth, NH 03801
603.430.9282

WWW.HALEYWARD.COM

- NOTES:**
- 1) PARCEL IS SHOWN ON THE CITY OF PORTSMOUTH ASSESSOR'S MAP 229 AS LOT 8B.
 - 2) OWNERS OF RECORD:
ATLAS COMMONS, LLC
3 PLEASANT STREET, SUITE 400
PORTSMOUTH, NH 03801
6474/1538
 - 3) THE PARCEL IS NOT IN A FLOOD HAZARD ZONE AS SHOWN ON FIRM PANEL 3301500270E, EFFECTIVE MAY 17, 2005
 - 4) EXISTING LOT AREA:
98,124 S.F.
2.2526 AC
 - 5) PARCEL IS LOCATED IN THE GATEWAY NEIGHBORHOOD CORRIDOR (G1) DISTRICT.
 - 6) DIMENSIONAL REQUIREMENTS:
SEE ZONING ORDINANCE SECTION 10.5822.10
 - 7) THE PURPOSE OF THIS PLAN IS TO SHOW A PROPOSED BUILDING ADDITION ON TAX MAP 229 LOT 8B.
 - 8) DESIGN BASED ON ARCHITECTURAL PLAN BY ARCOVE ARCHITECTS DATED 8/22/23.
 - 9) CONVERSION OF TUSCAN MARKETPLACE TO RESTAURANT (NORTHEASTERN THAI, LLC) APPROVED UNDER PERMIT: LU-22-254

COMMERCIAL DEVELOPMENT
581 LAFAYETTE ROAD
PORTSMOUTH, N.H.

NO.	DESCRIPTION	DATE
4	TABLES & PARKING	1/24/24
3	LANDSCAPE AREA, IMPERVIOUS TABLE	1/2/24
2	IMPERVIOUS SURFACE TABLE	12/19/23
1	ISSUED FOR APPROVAL	11/20/23
0	ISSUED FOR COMMENT	8/31/23

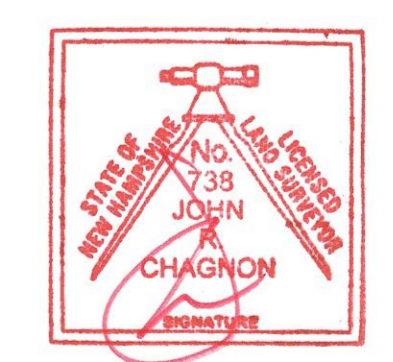

SCALE: 1"=20' JULY 2023

SITE PLAN **C3**

- PORTSMOUTH APPROVAL CONDITIONS NOTES:**
- 1) ALL CONDITIONS ON THIS PLAN SET SHALL REMAIN IN EFFECT IN PERPETUITY PURSUANT TO THE REQUIREMENTS OF THE CITY OF PORTSMOUTH SITE PLAN REVIEW REGULATIONS.
 - 2) THIS SITE PLAN SHALL BE RECORDED IN THE ROCKINGHAM COUNTY REGISTRY OF DEEDS.
 - 3) ALL IMPROVEMENTS SHOWN ON THIS SITE PLAN SHALL BE CONSTRUCTED AND MAINTAINED IN ACCORDANCE WITH THE PLAN BY THE PROPERTY OWNER AND ALL FUTURE PROPERTY OWNERS. NO CHANGES SHALL BE MADE TO THIS SITE PLAN WITHOUT THE EXPRESS APPROVAL OF THE PORTSMOUTH PLANNING DIRECTOR.

APPROVED BY THE PORTSMOUTH PLANNING BOARD

CHAIRMAN _____ DATE _____

ID	Qty	Botanical Name	Common Name	Scheduled Size
ACT	29	Actaea racemosa	Bugbane	1 Gal.
AMH	7	Amsonia hubrichtii	Arkansas Blue Star	1 Gal.
AMT	7	Amsonia tabernaemontana	Eastern Blue Star	1 Gal.
AOS	21	Aster oblongifolius 'October Skies'	Aromatic Aster	2 QT
BAP	5	Baptisia australis 'Screaming Yellow'	False Indigo	2 QT
CARY	9	Caryopteris clandonensis 'First Choice'	First Choice Bluebeard	2 QT
CE	50	Carex eburnea	Seersucker Sedge	2 QT
CV	50	Coreopsis verticillata 'Moonbeam'	Threadleaf Coreopsis	2 QT
CWB	20	Chrysanthemum weyrichii 'White Bomb'	Dwarf Chrysanthemum	2 QT
EP	51	Epimedium x rubrum 'Sweetheart'	Barrenwort	1 QT
EUP	9	Eupatorium maculatum 'Gateway'	Joe Pye Weed	Plug
GMB	20	Geranium macrorrhizum 'Bevan's'	Cranesbill	2 QT
HEL	5	Helianthus salicifolius	Willowleaf Sunflower	2 QT
HEU	33	Heuchera villosa 'Autumn Bride'	Autumn Bride Coral Bells	2 QT
HSE	11	Helenium 'Sahin's Early Flowerer'	Sahin's Early Flowerer Sneezeweed	2 QT
PVS	17	Panicum virgatum 'Shenandoah'	Shenandoah Switch Grass	2 Gal.
PX	101	Polystichum acrostichoides	Christmas Fern	2 QT
RF	7	Rudbeckia fulgida 'Goldstrum'	Goldstrum Black-Eyed Susan	2 QT
SH	10	Sporobolus heterolepis	Prairie Dropseed	1 Gal.
SO	7	Stachys officinalis	Bishop's Wort	2 QT
SPA	14	Spiraea japonica 'Alpina'	Alpine Spiraea	2 QT
TC	12	Thermopsis caroliniana	Carolina Lupine	2 QT
VER	37	Vernonia lettermannii 'Iron Butterfly'	Iron Butterfly Ironweed	2 QT
WAL	49	Waldsteinia ternata	Siberian Barren Strawberry	2 QT

ID	Qty	Botanical Name	Common Name	Scheduled Size
AAB	5	Amelanchier grandiflora 'Autumn Brilliance'	Autumn Brilliance Serviceberry	2 1/1" Cal.
BBG	24	Buxus microphylla 'Baby Gem'	Baby Gem Boxwood	4-4 1/2'
BDI	7	Buddleia 'Davidii'	Butterfly Bush	4-5'
CFF	21	Carpinus betulus 'Frans Fontaine'	Frans Fontaine Hornbeam	1 1/2-2" Cal.
HAL	3	Halesia carolina 'Jersey Belle'	Jersey Belle Carolina Silverbelle	1 1/2" Cal.
HYP	21	Hypericum 'Hidcote'	St. Johnswort	5 Gal.
JPN	22	Juniperus procumbens 'Nana'	Dwarf Japanese Garden Juniper	3 Gal.
LT	1	Liriodendron tulipifera	Tulip Tree	2 1/2" Cal.
MD	12	Microbiota decussata	Russian Arborvitae	2 G
PHC	1	Pinus sylvestris 'Hillside Creeper'	Hillside Creeper Scotch Pine	3 Gal.
PSM	6	Pinus strobus 'Minuta'	Minuta White Pine	3'
RGL	50	Rhus aromatica 'Grow Low'	Grow Low Sumac	18"+ Ht.
SMK	13	Syringa patula 'Miss Kim'	Miss Kim Lilac	3-4' Ht.
TJR	18	Thuja plicata 'Junior Giant'	Junior Giant Arborvitae	8-10'
TOS	20	Thuja occidentalis 'Smaragd'	American Arborvitae	8-10'



LAFAYETTE ROAD U.S. ROUTE 1

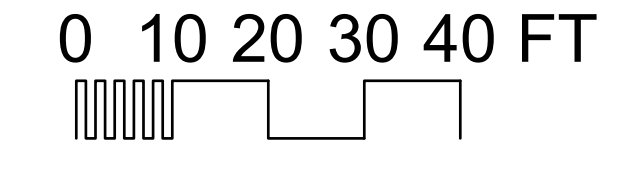

NOTE: IRRIGATION IN THE FORM OF SPRINKLER HEADS IN THE LAWN AREAS AND DRIP IRRIGATION IN PLANTING BEDS SHALL BE SOURCED FROM THE CITY OF PORTSMOUTH'S MUNICIPAL WATER, AND SHALL INCLUDE A BACK FLOW PREVENTION.

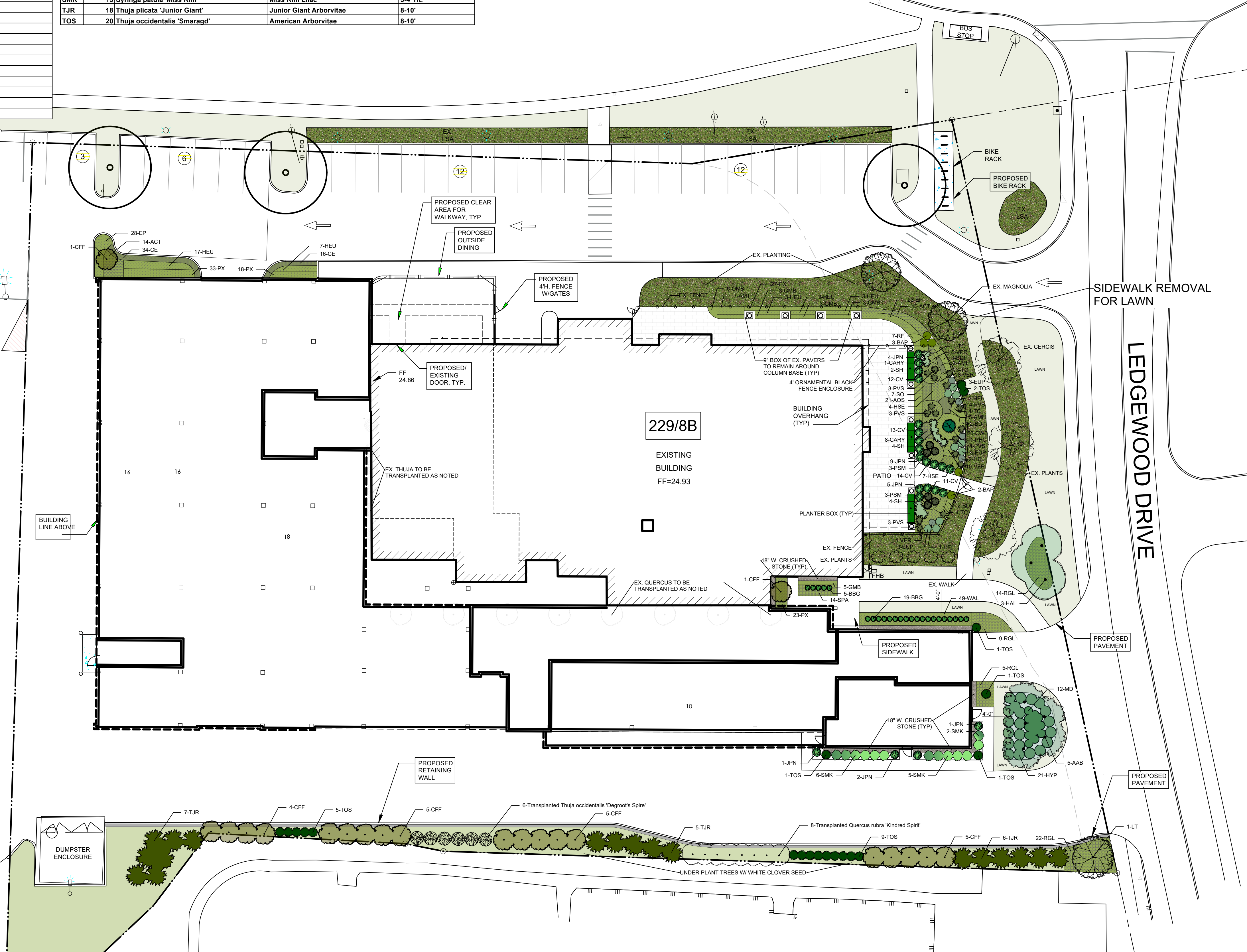

No.	Date	By	Revision Notes
B	1/10/2024		TREES + GREENERY COMMENTS
A	1/2/2024		TAC COMMENTS

No.	Date	Issue Notes

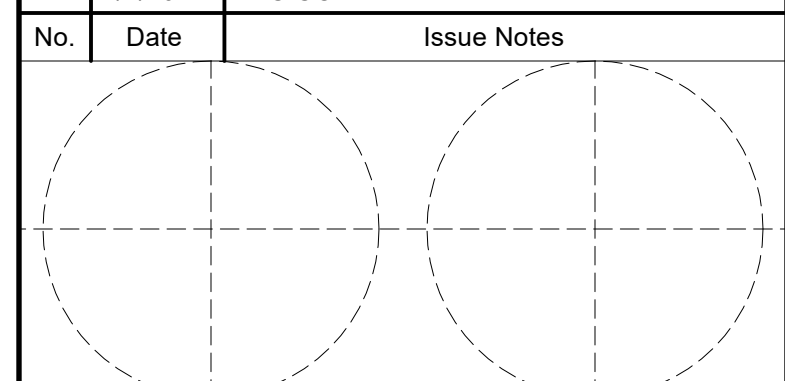

Design Firm	terra firma landscape architecture 163.a Court Street Portsmouth, NH
Consultant	
Project Title	581 LAFAYETTE
Sheet Title	Landscape Plan
Project Manager	TC
Project ID	581 LAFAYETTE
Drawn By	TP
Scale	1:240
Reviewed By	TP
Sheet No.	L-1
Date	11/20/2023
CAD File Name	581LAFAYETTE11024.vwx
	of 2

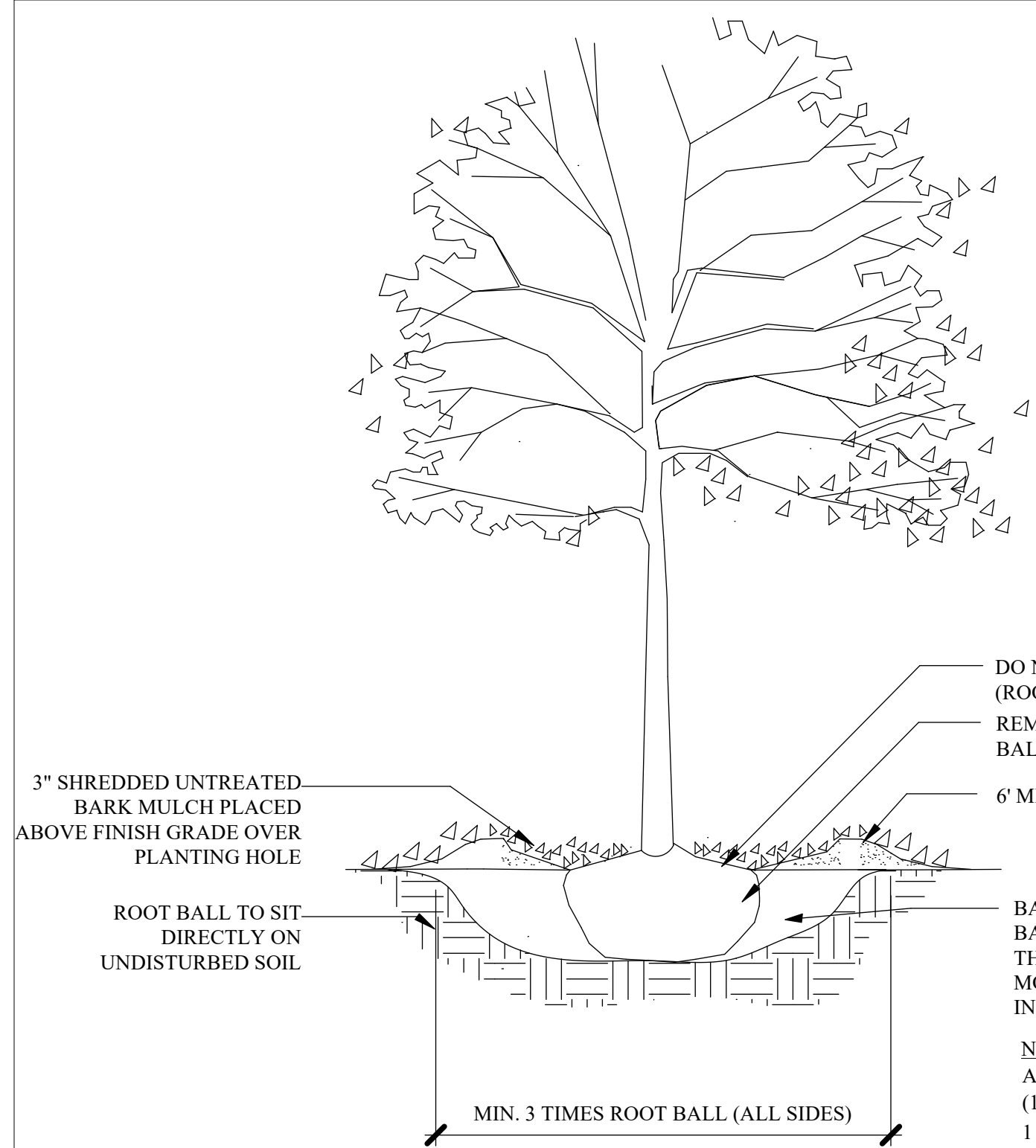
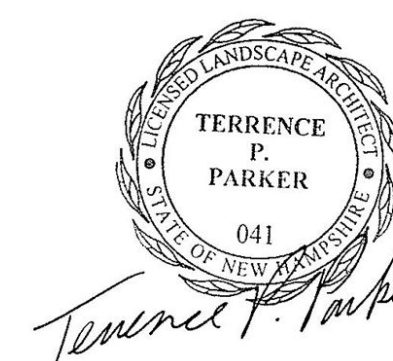

1
L-2 **TREE PLANTING - 2"+ CAL.**
SCALE: NTS

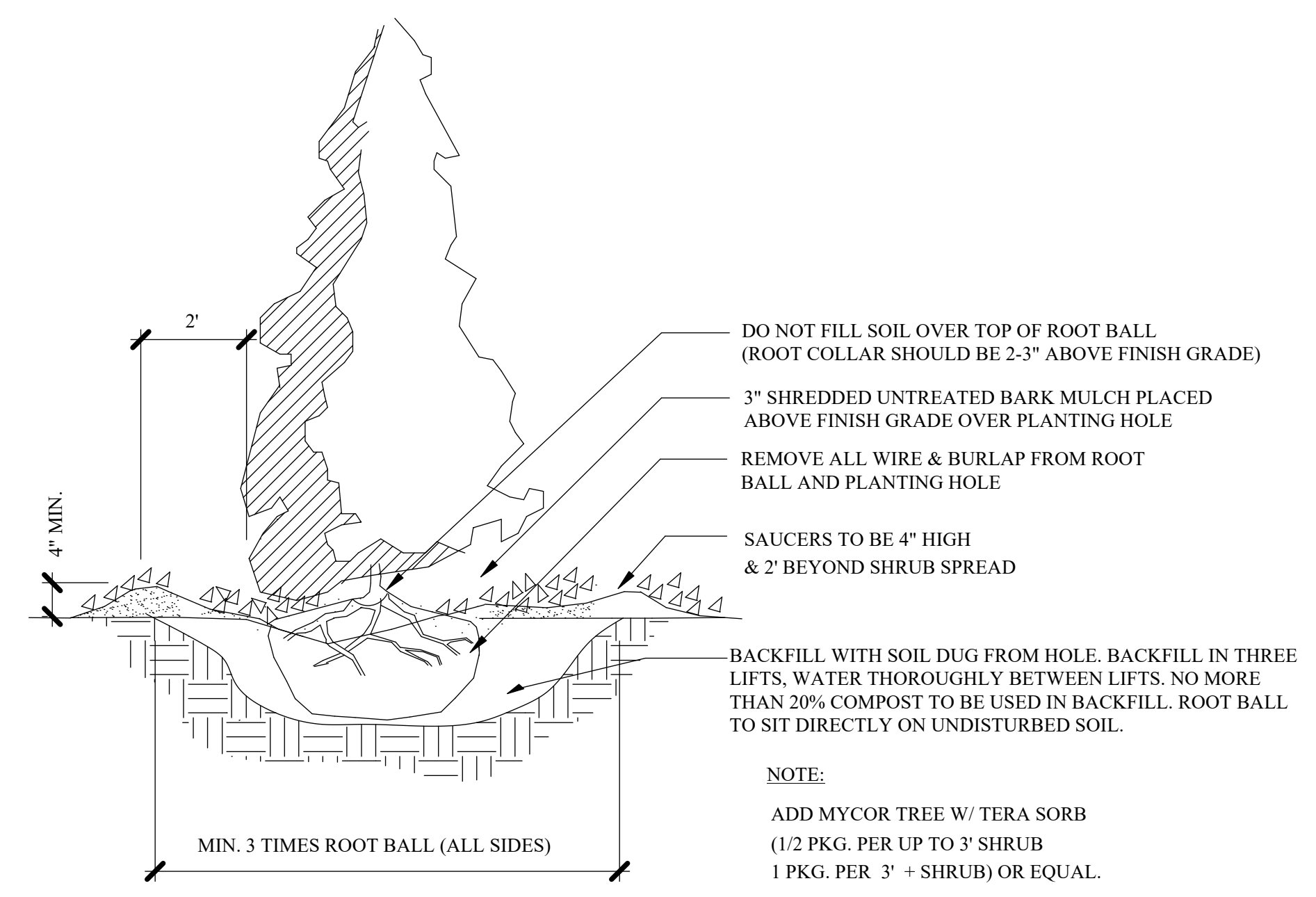

2
L-2 **PYRAMIDAL EVERGREEN TREE PLANTING**
SCALE: NTS

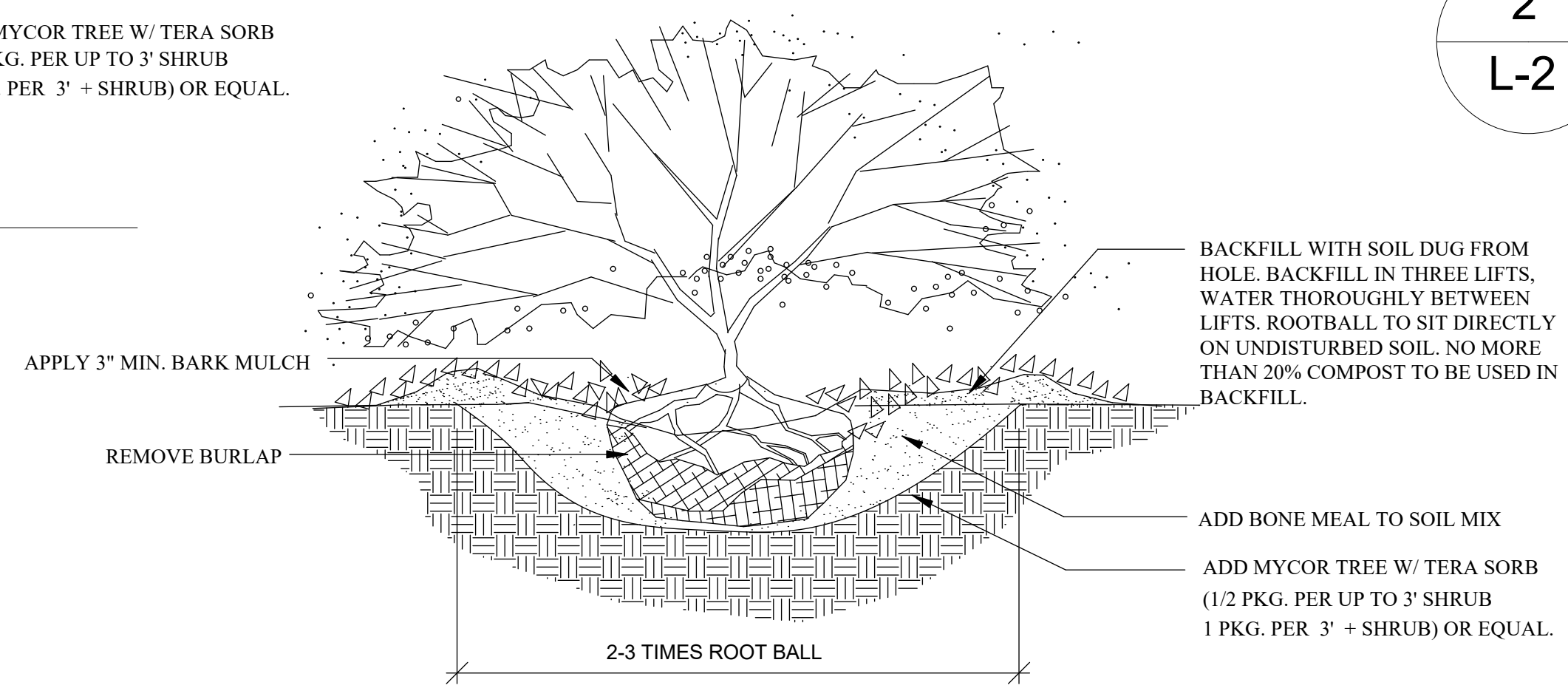

3
L-2 **B&B SHRUB PLANTING**
SCALE: NTS

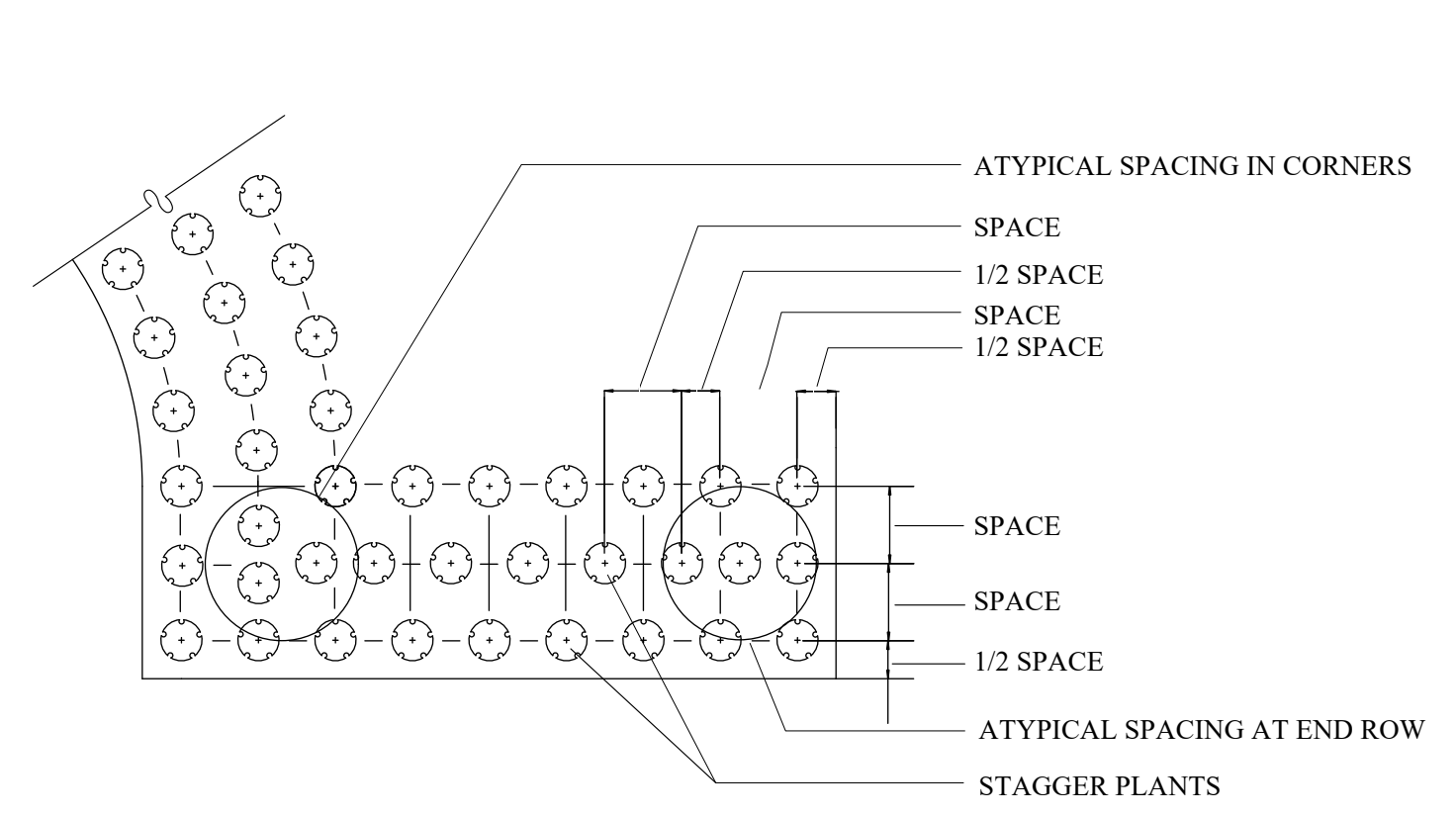

4
L-2 **GROUND COVER SPACING DETAIL**
SCALE: NTS

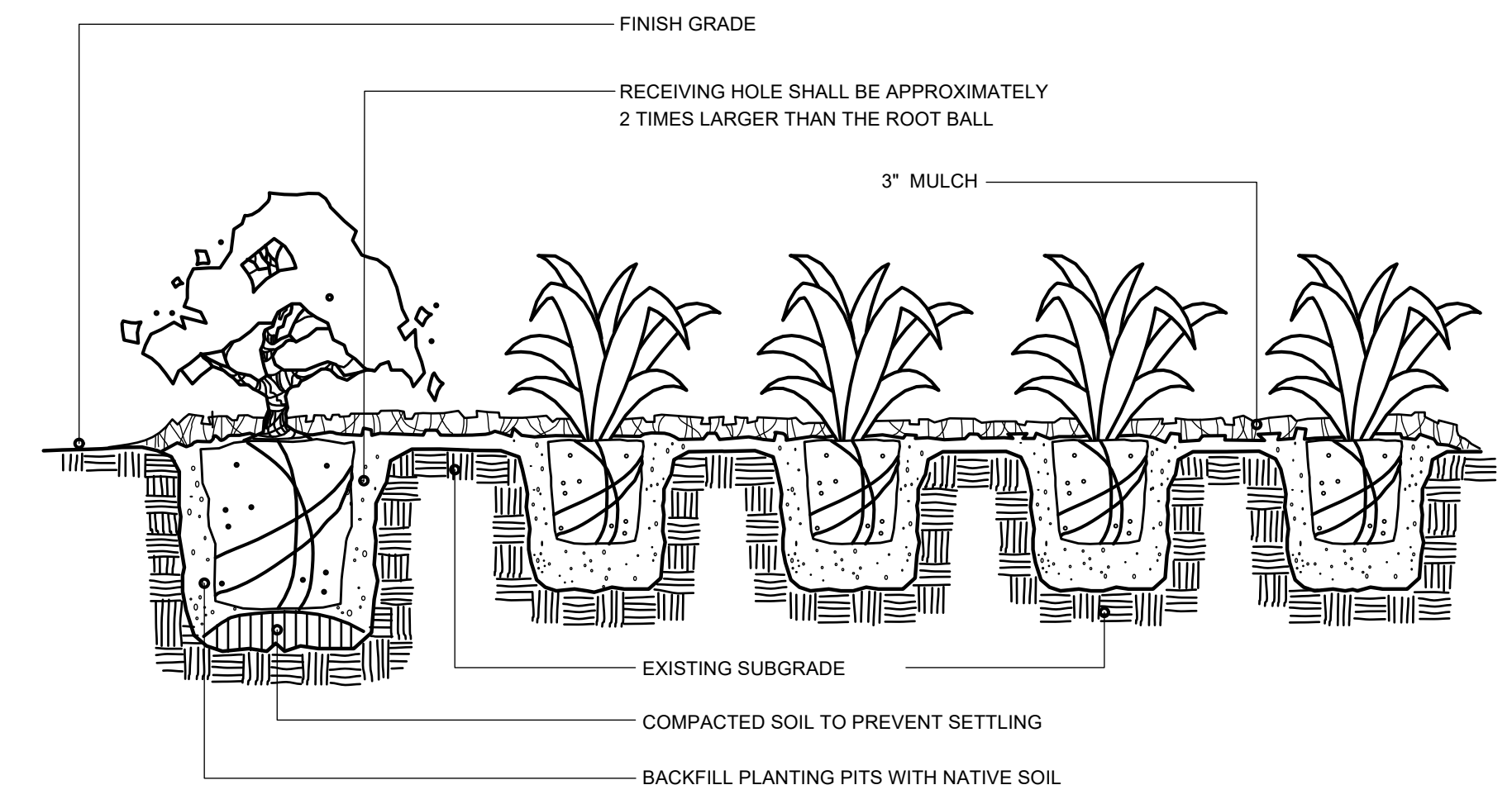

5
L-2 **SHRUB/GROUND COVER PLANTING DETAIL**
SCALE: NTS

LANDSCAPE NOTES:

1. THE CONTRACTOR SHALL LOCATE AND VERIFY THE EXISTENCE OF ALL UTILITIES PRIOR TO STARTING WORK.
2. THE CONTRACTOR SHALL SUPPLY ALL PLANT MATERIALS IN QUANTITIES SUFFICIENT TO COMPLETE THE PLANTINGS SHOWN ON THE DRAWINGS.
3. ALL MATERIAL SHALL CONFORM TO THE GUIDELINES ESTABLISHED BY THE CURRENT AMERICAN STANDARD FOR NURSERY STOCK PUBLISHED BY THE AMERICAN ASSOCIATION OF NURSERYMEN.
4. ALL PLANT SUBSTITUTIONS MUST BE APPROVED BY THE LANDSCAPE ARCHITECT.
5. ALL PLANT MATERIALS SHALL BE EXACTLY AS SPECIFIED BY THE LANDSCAPE ARCHITECT. IF PLANT SPECIES CULTIVARS ARE FOUND TO VARY FROM THAT SPECIFIED AT ANY TIME DURING THE GUARANTEE PERIOD, THE LANDSCAPE ARCHITECT RESERVES THE RIGHT TO HAVE THE CONTRACTOR REPLACE THAT PLANT MATERIAL. THE LANDSCAPE ARCHITECT RESERVES THE RIGHT TO REJECT ANY PLANT DELIVERED TO THE SITE FOR AESTHETIC REASONS BEFORE PLANTING. THE LANDSCAPE CONTRACTOR IS RESPONSIBLE FOR THE QUALITY FOR ALL THE PLANTS.
6. PLANTS SHALL BE SUBJECT TO INSPECTION AND APPROVAL AT THE PLACE OF GROWTH, UPON DELIVERY OR AT THE JOB SITE WHILE WORK IS ON-GOING TO CONFORMITY TO SPECIFIED QUALITY, SIZE AND VARIETY.
7. PLANTS FURNISHED IN CONTAINERS SHALL HAVE THE ROOTS WELL ESTABLISHED IN THE SOIL MASS AND SHALL HAVE AT LEAST ONE (1) GROWING SEASON. ROOT-BOUND PLANTS OR INADEQUATELY SIZED CONTAINERS TO SUPPORT THE PLANT MAY BE DEEMED UNACCEPTABLE.
8. NO PLANT SHALL BE PUT IN THE GROUND BEFORE GRADING HAS BEEN FINISHED AND APPROVED BY THE LANDSCAPE ARCHITECT.
9. ALL PLANTS SHALL BE INSTALLED AND DETAILED PER PROJECT SPECIFICATIONS.
10. ALL PLANTS SHALL BE WATERED THOROUGHLY TWICE DURING THE FIRST 24-HOUR PERIOD AFTER PLANTING. ALL PLANTS SHALL BE WATERED WEEKLY, OR MORE OFTEN IF NECESSARY, DURING THE FIRST GROWING SEASON.
11. ALL PLANTS SHALL BE GUARANTEED BY THE CONTRACTOR FOR NOT LESS THAN ONE FULL YEAR FROM THE TIME OF PROVISIONAL ACCEPTANCE. DURING THIS TIME, THE OWNER SHALL MAINTAIN ALL PLANT MATERIALS IN THE ABOVE MANNER. IT IS THE CONTRACTOR'S RESPONSIBILITY TO INSPECT THE PLANTS TO ENSURE PROPER CARE. IF THE CONTRACTOR IS DISSATISFIED WITH THE CARE GIVEN, HE SHALL IMMEDIATELY, AND IN SUFFICIENT TIME TO PERMIT THE CONDITION TO BE RECTIFIED, NOTIFY THE LANDSCAPE ARCHITECT IN WRITING OR OTHERWISE FORFEIT HIS CLAIM. LANDSCAPE CONTRACTOR SHALL PRUNE PLANTINGS OF DEAD LIMBS OR TWIGS DURING THE FIRST YEAR OF GROWTH.
12. FINAL ACCEPTANCE BY THE LANDSCAPE ARCHITECT WILL BE MADE UPON THE CONTRACTOR'S REQUEST AFTER ALL CORRECTIVE WORK HAS BEEN COMPLETED.
13. LANDSCAPE CONTRACTOR SHOULD REPLACE DEAD PLANTINGS IMMEDIATELY UPON OWNER DIRECTION WITHIN THE WARRANTY PERIOD AND AGAIN AT THE END OF THE GUARANTEE PERIOD. THE CONTRACTOR SHALL HAVE REPLACED ANY PLANT MATERIAL THAT IS MISSING, NOT TRUE TO SIZE AS SPECIFIED, THAT HAVE DIED, THAT HAVE LOST THEIR NATURAL SHAPE DUE TO DEAD BRANCHES, EXCESSIVE PRUNING OR INADEQUATE OR IMPROPER CARE, OR THAT ARE, IN THE OPINION OF THE LANDSCAPE ARCHITECT, IN UNHEALTHY OR UNSIGHTLY CONDITION.
14. ALL LANDSCAPE AREAS TO BE GRASS COMMON TO REGION EXCEPT FOR INTERIOR LANDSCAPED ISLANDS OR WHERE OTHER PLANT MATERIAL IS CALLED FOR.
15. ALL TREES AND SHRUBS TO BE PLANTED IN MULCH BEDS WITH DEFINED AND CUT EDGES TO SEPARATE TURF GRASS AREAS.
16. FOR ANY LANDSCAPE AREA SO DESIGNATED TO REMAIN, WHETHER ON OR OFF-SITE, REMOVE WEEDS, ROCKS, CONSTRUCTION ITEMS, ETC., THEN APPLY GRASS SEED OR PINE BARK MULCH AS DEPICTED ON PLANS.
17. LANDSCAPE CONTRACTOR SHALL FEED AND PRUNE EX. TREES, ON OR JUST OFF SITE, THAT HAVE EXPERIENCED ROOT BASE INTRUSION OR DAMAGE DURING CONSTRUCTION IMMEDIATELY AND FOR THE DURATION OF THE WARRANTY PERIOD AT THE DIRECTION OF THE LANDSCAPE ARCHITECT.
18. EXISTING TREES TO REMAIN SHALL BE PROTECTED WITH TEMPORARY SNOW FENCING AT THE EDGE OF THE EX. TREE CANOPY THE CONTRACTOR SHALL NOT STORE VEHICLES OR MATERIALS WITHIN THE LANDSCAPED AREAS. ANY DAMAGE TO EXISTING TREES, SHRUBS OR LAWN SHALL BE REPAIRED BY THE CONTRACTOR AT NO ADDITIONAL COST TO THE OWNER.
19. ALL MULCH AREAS SHALL RECEIVE A 2-3" LAYER OF SHREDDED PINE BARK MULCH.
20. ALL WORK SHALL BE DONE IN STRICT ACCORDANCE WITH PROJECT SPECIFICATIONS.
21. ALL PLANTING HOLES TO BE HAND-DUG, EXCEPT IN NEW CONSTRUCTION WITH NEW PLANTING PITS, PLANTING NEAR CURBS, OR AREAS WHERE SILVA CELLS WILL BE USED. IF HOLES ARE MACHINE-DUG, BOTTOM OF HOLES NEED TO BE THE APPROPRIATE HEIGHT, AND FIRMED BY THE MACHINE TO CREATE STABILITY FOR THE PLANT MATERIAL.

PLEASE NOTE: THIS SHEET IS SCALED FOR 22 BY 34 PAPER, DO NOT REDUCE OR ENLARGE.

No.	Date	By	Revision Notes
B	1/10/2024		TREES + GREENERY COMMENTS
A	1/2/2024		TAC COMMENTS

No.	Date	Issue Notes

Design Firm	terra firma landscape architecture 163.a Court Street Portsmouth, NH
Consultant	
Project Title	581 LAFAYETTE
Sheet Title	Landscape Plan
Project Manager	Project ID: 581 LAFAYETTE
Drawn By: TC	Scale: AS NOTED
Reviewed By: TP	Sheet No. L-2
Date: 11/20/2023	of 2
CAD File Name: 581LAFAYETTE11024.vwx	

Symbol	Qty	Label	Arrangement	Description	[MANUFAC]	Tag
	6	B3	Single	WAT44-AC-36NB-80-3K-UNV-DIR3-PT-FINISH	BEACON PRODUCTS	EXISTING
	11	PL	Single	EL188-3L3KUV-H70	KIM LIGHTING	EXISTING
	4	W1	Single	LEW-30001-5.5W-T4-W30-CXX	LIGMAN	PROPOSED
	2	W2	Single	UGN-30081-72W-W30-XX-120/277V	LIGMAN	PROPOSED
	2	W3	Single	LEW-30021-20W-T3-W30-CXX	LIGMAN	PROPOSED
	5	W4	Single	LEW-30021-28W-T4-W30-CXX	LIGMAN	PROPOSED

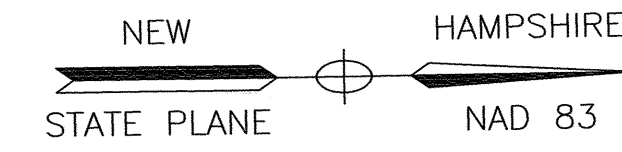

LAFAYETTE ROAD U.S. ROUTE 1

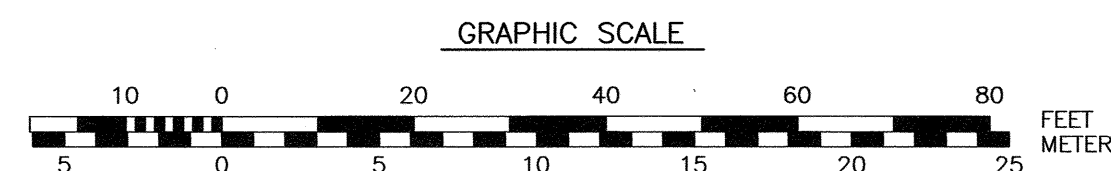
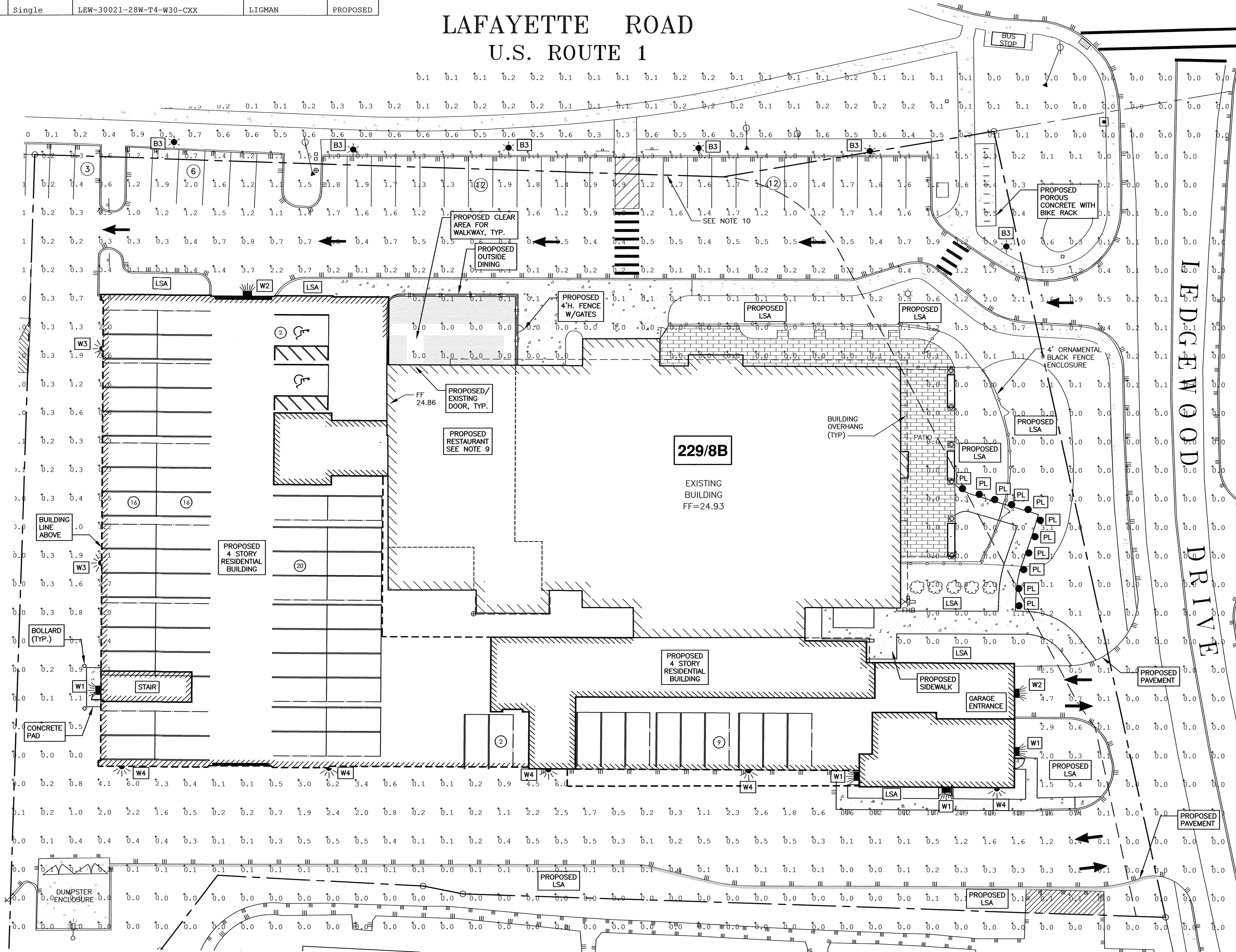

- NOTES:**
- 1) PARCEL IS SHOWN ON THE CITY OF PORTSMOUTH ASSESSOR'S MAP 229 AS LOT 8B.
 - 2) OWNERS OF RECORD:
ATLAS COMMONS, LLC
3 PLEASANT STREET, SUITE 400
PORTSMOUTH, NH 03801
6474/1538
 - 3) THE PURPOSE OF THIS PLAN IS TO SHOW PROPOSED LIGHTING ON TAX MAP 229 LOT 8B.

COMMERCIAL DEVELOPMENT 581 LAFAYETTE ROAD PORTSMOUTH, N.H.

NO.	DESCRIPTION	DATE
0	ISSUED FOR APPROVAL	1/24/24
REVISIONS		

SCALE: 1"=20'

JULY 2023

LIGHTING PLAN

L3

P:\NH\5010156-Nicklabb-Properties\1397-03-Lafayette Rd., Portsmouth-ARC\2023 Site Plan 1397-03\Plan & Specs\Site\Final Set\1397-03 LIGHTING 2023.dwg, 1/24/2024 11:56:18 AM, Portsmouth Placer Canon TX3000.dwg

REQUIRED PARKING:

Level	Room No.	# bedrooms	Area (sq ft)	spaces/unit	Workforce	Accessible
LEVEL 5	B504	STUDIO	356	0.50		
LEVEL 4	B406	STUDIO	425	0.50		
LEVEL 3	B306	STUDIO	426	0.50		
LEVEL 5	A505	STUDIO	426	0.50		
LEVEL 5	A507	STUDIO	426	0.50		
LEVEL 5	A503	STUDIO	427	0.50		
LEVEL 5	A504	STUDIO	427	0.50		
LEVEL 5	A509	STUDIO	427	0.50		
LEVEL 5	A511	STUDIO	443	0.50		
LEVEL 5	B503	STUDIO	479	0.50		
LEVEL 4	B411	STUDIO- ACCESSIBLE	487	0.50	Fully Accessible-1	
LEVEL 5	A508	STUDIO	499	0.50		
LEVEL 3	B304	1BR	502	0.50		
LEVEL 4	B404	1BR	531	0.50		
LEVEL 5	B502	1BR	541	0.50		
LEVEL 4	B409	1BR	556	0.50		
LEVEL 2	B207	1BR	559	0.50		
LEVEL 3	B311	1BR	562	1.00		
LEVEL 3	B309	1BR	564	1.00		
LEVEL 4	A407	STUDIO- ACCESSIBLE	570	1.00	Fully Accessible-2	
LEVEL 4	B410	1BR	581	1.00		
LEVEL 4	B505	1BR	588	1.00		
LEVEL 5	B506	1BR	589	1.00		
LEVEL 3	B305	1BR	631	1.00		
LEVEL 4	B405	1BR	629	1.00		
LEVEL 3	B303	1BR	630	1.00		
LEVEL 4	B403	1BR	636	1.00		
LEVEL 4	A408	1BR	644	1.00		
LEVEL 3	B307	1BR	645	1.00		
LEVEL 4	B408	1BR	645	1.00		
LEVEL 3	B310	1BR- ACCESSIBLE	648	1.00	Fully Accessible-3	
LEVEL 2	A203	1BR	650	1.00		
LEVEL 4	B401	1BR	651	1.00		
LEVEL 4	B206	1BR	652	1.00		
LEVEL 3	B308	1BR	659	1.00		
LEVEL 4	B407	1BR	659	1.00		
LEVEL 5	A502	1BR	672	1.00		
LEVEL 2	A205	1BR	675	1.00		
LEVEL 3	A307	1BR	675	1.00		
LEVEL 3	A303	1BR	676	1.00		
LEVEL 3	B301	1BR	684	1.00		
LEVEL 4	B402	2BR	707	1.00		
LEVEL 2	A208	1BR	729	1.00		
LEVEL 3	A308	1BR	729	1.00		
LEVEL 4	A403	1BR	734	1.00		
LEVEL 2	A209	1BR	739	1.00		
LEVEL 3	A309	1BR	739	1.00		
LEVEL 2	B202	2BR	785	1.00		
LEVEL 3	B302	2BR	785	1.00		
LEVEL 3	A306	1BR	795	1.00		
LEVEL 2	A206	1BR	803	1.30		
LEVEL 4	A406	1BR	803	1.30		
LEVEL 5	B507	2BR-ACCESSIBLE	826	1.30	Fully Accessible-4	
LEVEL 2	B201	2BR-WORKFORCE	879	1.30	Workforce 1	
LEVEL 5	A506	1BR-WORKFORCE/ACCESSIBL	914	1.30	Workforce 2	Fully Accessible-5
LEVEL 2	A207	1BR-WORKFORCE/ACCESSIBL	951	1.30	Workforce 3	Fully Accessible-6
LEVEL 5	B501	2BR-WORKFORCE	1026	1.30	Workforce 4	
LEVEL 2	B203	3BR-WORKFORCE	1148	1.30	Workforce 5	
LEVEL 4	A401	3BR-WORKFORCE	1287	1.30	Workforce 6	
LEVEL 3	A301	3BR-WORKFORCE	1402	1.30	Workforce 7	
LEVEL 4	A402	3BR-WORKFORCE	1462	1.30	Workforce 8	
LEVEL 2	B204	3BR-WORKFORCE	1469	1.30	Workforce 9	
LEVEL 5	A510	3BR-WORKFORCE	1487	1.30	Workforce 10	
LEVEL 2	B205	3BR-WORKFORCE/ACCESSIBL	1497	1.30	Workforce 11	Fully Accessible-7
LEVEL 3	A302	3BR-WORKFORCE	1570	1.30	Workforce 12	
LEVEL 2	A202	3BR-WORKFORCE	1616	1.30	Workforce 13	
LEVEL 3	A305	3BR-WORKFORCE	1698	1.30	Workforce 14	
LEVEL 2	A204	3BR-WORKFORCE	2164	1.30	Workforce 15	
LEVEL 2	A201	3BR	2167	1.30		
LEVEL 3	A304	3BR-ACCESSIBLE	2178	1.30	Fully Accessible-8	
LEVEL 4	A405	3BR	2208	1.30		
LEVEL 4	A404	3BR	2430	1.30		
Total Units				72		
Visitor Parking - 1 space per every 5 dwellings				14.40	14.4	860
Bicycle parking deduction - 1 space for 6 bikes max 5% =				3.505		
TOTAL residential automobile parking				80.99	81	ROUNDED UP

Apartments Parking Required	
with gateway deduct -20%	
subtotal parking spaces required	81
Gateway deduct -20%	-16.2
Apartment Parking Required	65

Restaurant/Recreation Parking Required			
spaces/gfa	gfa or occ	spaces (rounded up)	w/20
1/100	13,982.00	140	112
1/350	1,060.00	4	4
1 per 4 occ.	20.00	5	
subtotal		149	
Gateway deduct -20%		-29.8	
Total restaurant/recreation parking required		120	120

total parking required all uses **185**

Land Use	Weekday				Weekend				Maximum Required
	daytime (8am-5pm)	spaces required	evening (6-12pm)	spaces required	daytime (8am-5pm)	spaces required	evening (6-midnight)	spaces required	
Apartments	60%	59.0	100%	65.0	80%	52.0	100%	65.0	65.0
Restaurant	70%	78.4	100%	78.4	80%	89.6	100%	112.0	112.0
Office	100%	4.0	20%	0.8	100%	0.4	5%	0.2	0.2
entertainment (golf)	40%	1.6	100%	4.0	80%	3.2	100%	4.0	4.0
Total Required		123.0		181.80		145.2		181.2	182

Total Parking Proposed	
In-building, level 3 + basement	138
Open air, on site	33
Off-site parking per deed ed easement	11
Total parking proposed	182
Excess (Defect)	0
Existing total available today	154
Proposed Net Increase (reduction) in parking	28

Car Parking Spaces Required per Unit Size	
0-500	0.5
500-750	1.0
751-1900	1.3

Bicycle Parking Required		
use	spaces required per use	total required
multifamily	1 bicycle for every 5 dwelling units	15
restaurant/rec	1 bicycle for every 10 car parking spaces	12
TOTAL Required		27
Total Bicycle Parking Provided (in building)		65
Motorcycle parking provided		3

Apartment Types - Unit Mix & Locations				
level	number of bedrooms per apartment			Total
	1	2	3	
5	5	2	3	15
4	3	9	3	19
3	3	10	3	20
2	5	2	6	18
total	16	29	10	72

Level	A	B	TOTAL
5	8	7	15
4	8	11	19
3	9	11	20
2	11	7	18
total	36	36	72

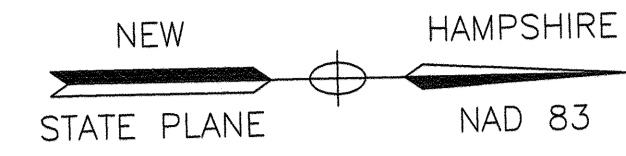
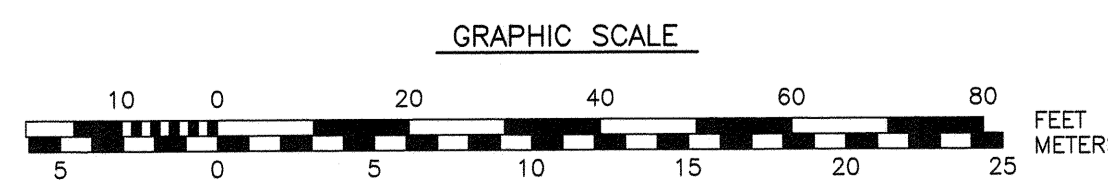
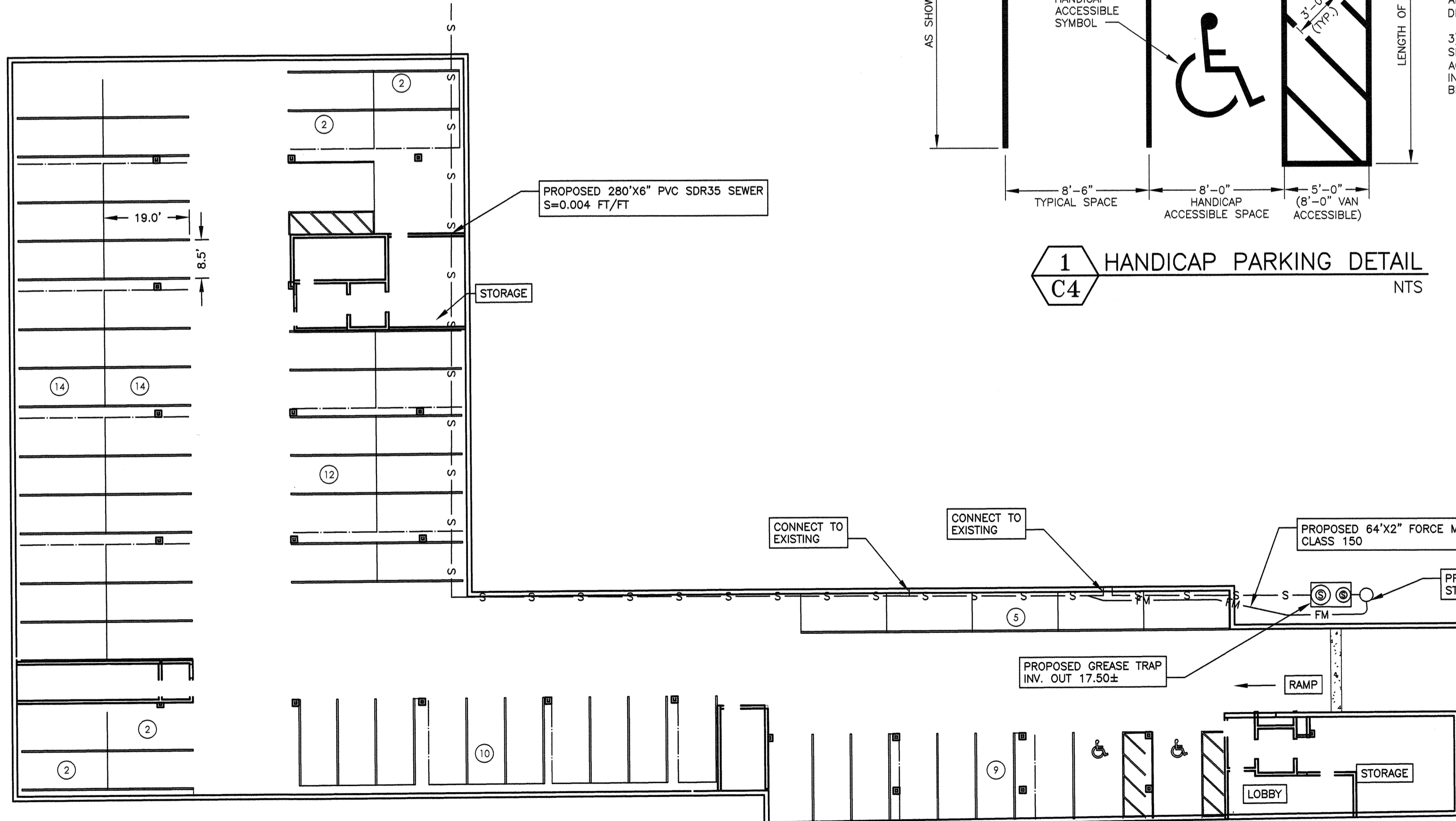

R7-8a
12" x 18"
SIGN ON POST
EACH SPACE SHALL HAVE THIS SIGN DISPLAYED PER ADA CODE

SIGNAGE

LEGEND SYMBOL

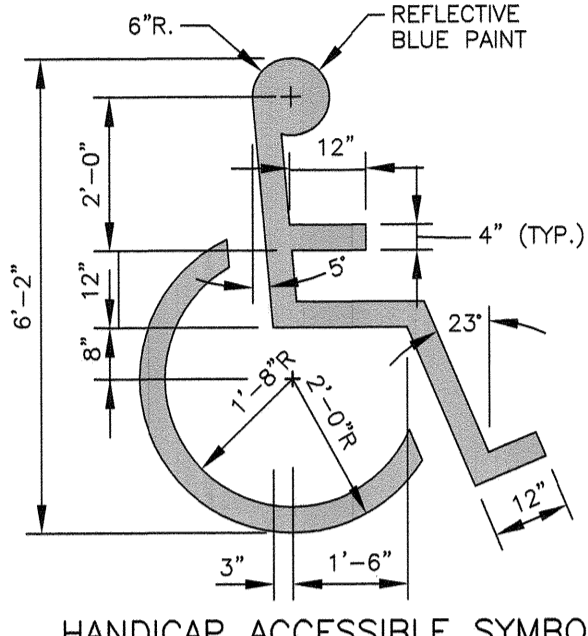

HANDICAP ACCESSIBLE SYMBOL



K-4438
12" x 18"
SIGN ON POST

SIGNAGE

PROVIDE SIGN (PER ADA CODE) AT EACH HANDICAP ACCESSIBLE SPACE

HANDICAP ACCESS AISLE NO PARKING SIGN

NOTES:

- 1) SYMBOL TO BE PAINTED IN ALL HANDICAPPED SPACES.
- 2) SYMBOL, PAINT AND SIGNAGE TO CONFORM TO AMERICANS WITH DISABILITIES ACT (ADA).
- 3) ALL VAN ACCESSIBLE SPACES SHALL HAVE "VAN ACCESSIBLE" PLATE INSTALLED ON SIGN POST BELOW HANDICAP SIGN.

NOTES:

- 1) PARCEL IS SHOWN ON THE CITY OF PORTSMOUTH ASSESSOR'S MAP 229 AS LOT 8B.
- 2) OWNERS OF RECORD:
ATLAS COMMONS, LLC
3 PLEASANT STREET, SUITE 400
PORTSMOUTH, NH 03801
6474/1538
- 3) THE PURPOSE OF THIS PLAN IS TO SHOW THE SUBSURFACE PARKING FOR THE PROPOSED SITE DEVELOPMENT ON ASSESSOR'S MAP 229 LOT 8B IN THE CITY OF PORTSMOUTH.
- 4) REQUIRED PARKING: (SEE TABLE)

COMMERCIAL DEVELOPMENT
581 LAFAYETTE ROAD
PORTSMOUTH, N.H.

NO.	DESCRIPTION	DATE
3	PARKING TABLES, PARKING LAYOUT	1/24/24
2	PARKING TABLES	12/19/23
1	ISSUED FOR APPROVAL	11/20/23
0	ISSUED FOR COMMENT	7/5/23

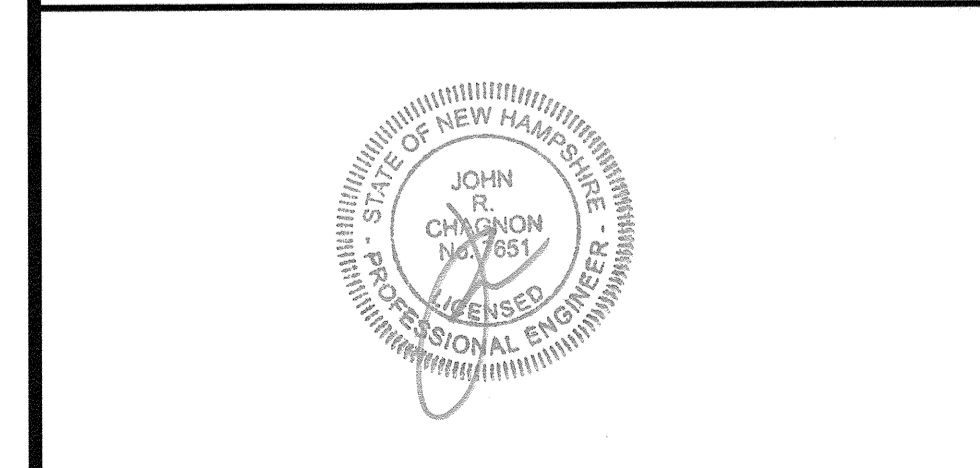

SCALE: 1"=20' JULY 2023

LOWER LEVEL PARKING PLAN **C4**

EXISTING SEWER STRUCTURE SCHEDULE					
STRUCTURE	PROP/EX	RIM	PIPE SIZE	INVERT	DIRECTION
SMH 1	EX	22.56	8" CI	13.26	IN
GREASE TRAP 1	EX	23.63	8" CI	13.21	OUT
GREASE TRAP 1	EX	23.63		17.23	OUT

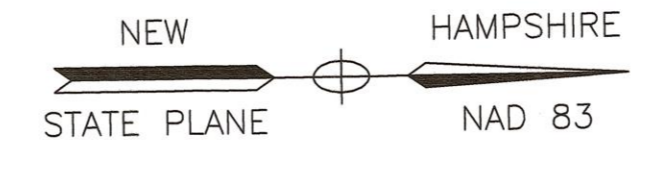

LAFAYETTE ROAD U.S. ROUTE 1

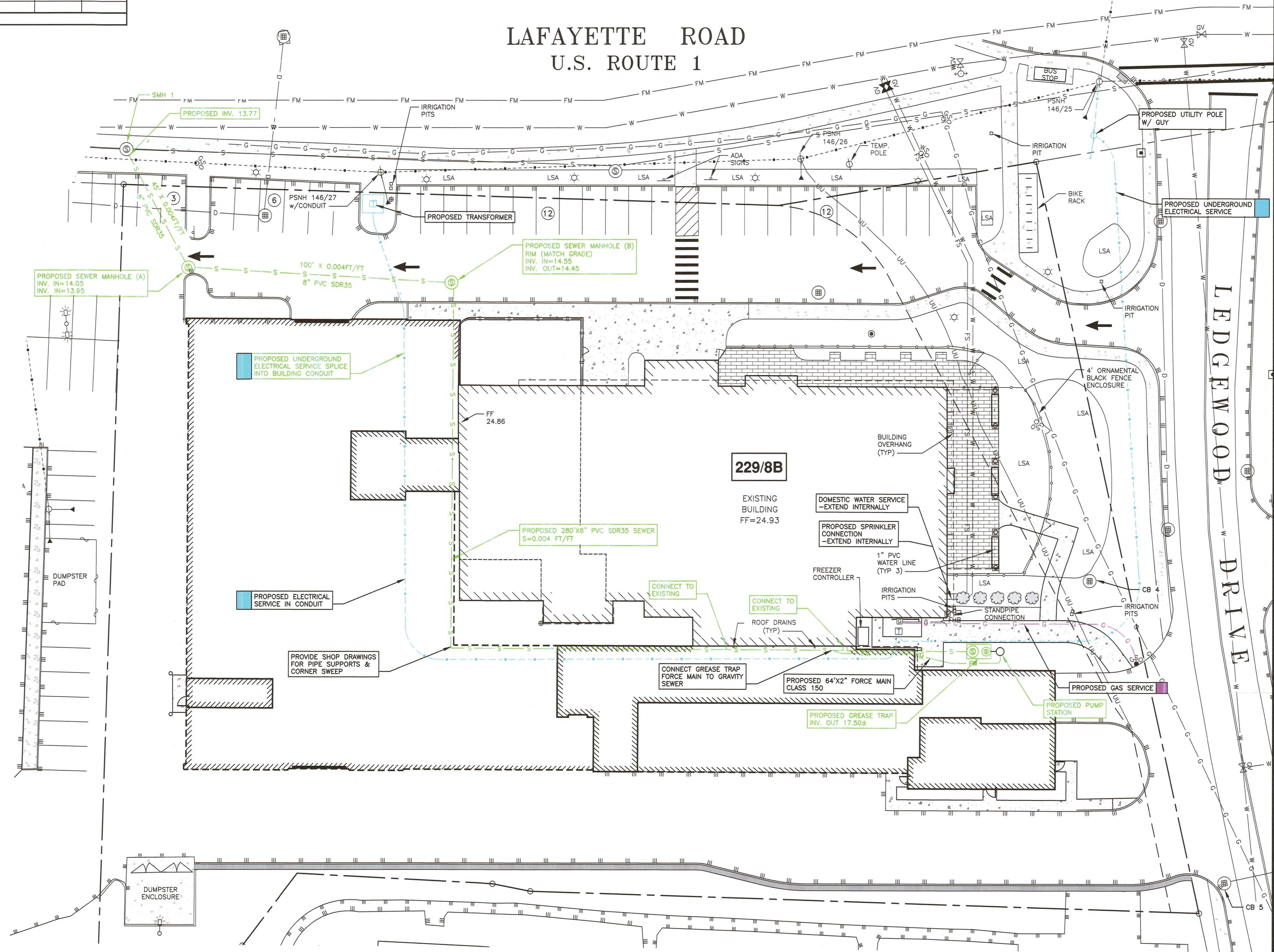

- NOTES:**
- 1) THE CONTRACTOR SHALL NOTIFY DIG SAFE AT 1-888-DIG-SAFE (1-888-344-7233) AT LEAST 72 HOURS PRIOR TO COMMENCING ANY EXCAVATION ON PUBLIC OR PRIVATE PROPERTY WITHIN 100 FEET OF UNDERGROUND UTILITIES. THE EXCAVATOR IS RESPONSIBLE TO MAINTAIN MARKS. DIG SAFE TICKETS EXPIRE IN THIRTY DAYS.
 - 2) UNDERGROUND UTILITY LOCATIONS ARE BASED UPON BEST AVAILABLE EVIDENCE AND ARE NOT FIELD VERIFIED. LOCATING AND PROTECTING ANY ABOVEGROUND OR UNDERGROUND UTILITIES IS THE SOLE RESPONSIBILITY OF THE CONTRACTOR AND/OR THE OWNER. UTILITY CONFLICTS SHOULD BE REPORTED AT ONCE TO THE DESIGN ENGINEER.
 - 3) CONTRACTOR SHALL INSTALL AND MAINTAIN EROSION CONTROL MEASURES IN ACCORDANCE WITH THE "NEW HAMPSHIRE STORMWATER MANUAL, VOLUME 3, EROSION AND SEDIMENT CONTROLS DURING CONSTRUCTION. (NHDES DECEMBER 2008).

COMMERCIAL DEVELOPMENT 581 LAFAYETTE ROAD PORTSMOUTH, N.H.

NO.	DESCRIPTION	DATE
3	FORCE MAIN	1/24/24
2	GREASE TRAP	12/19/23
1	ISSUED FOR APPROVAL	11/20/23
0	ISSUED FOR COMMENT	5/8/23



SCALE: 1"=20' FEBRUARY 2023

UTILITY PLAN **C5**

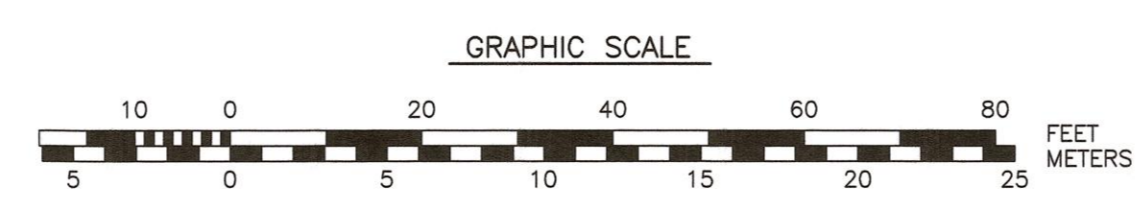

DRAINAGE STRUCTURE SCHEDULE

STRUCTURE	PROP/EX	RIM	PIPE SIZE/TYPE	INVERT IN	INVERT OUT	DIRECTION
DMH 1	EX	22.3	15"	17.60	17.40	W
DMH 2	EX	22.3	15"	17.40	17.40	W
DMH 3	PROP		24"	17.69	17.44	E
CB 1	EX	21.46		17.29	17.29	N
CB 2	EX	22.00	12"	18.00	17.95	S
CB 3	PROP	22.16	18"	17.80	17.70	N
CB 4	PROP	22.45	18"	17.90	17.90	S
CB 5	PROP	22.60	18"	18.02	18.02	S
CB 6	PROP	22.65	18"	18.09	18.09	S
CB 7	EX	24.16	12"	21.15	21.06	S
JELLYFISH FILTER	PROP	23.05	24"	17.41	17.31	S

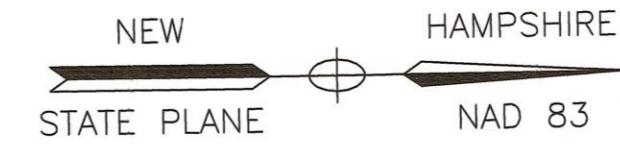

**LAFAYETTE ROAD
U.S. ROUTE 1**

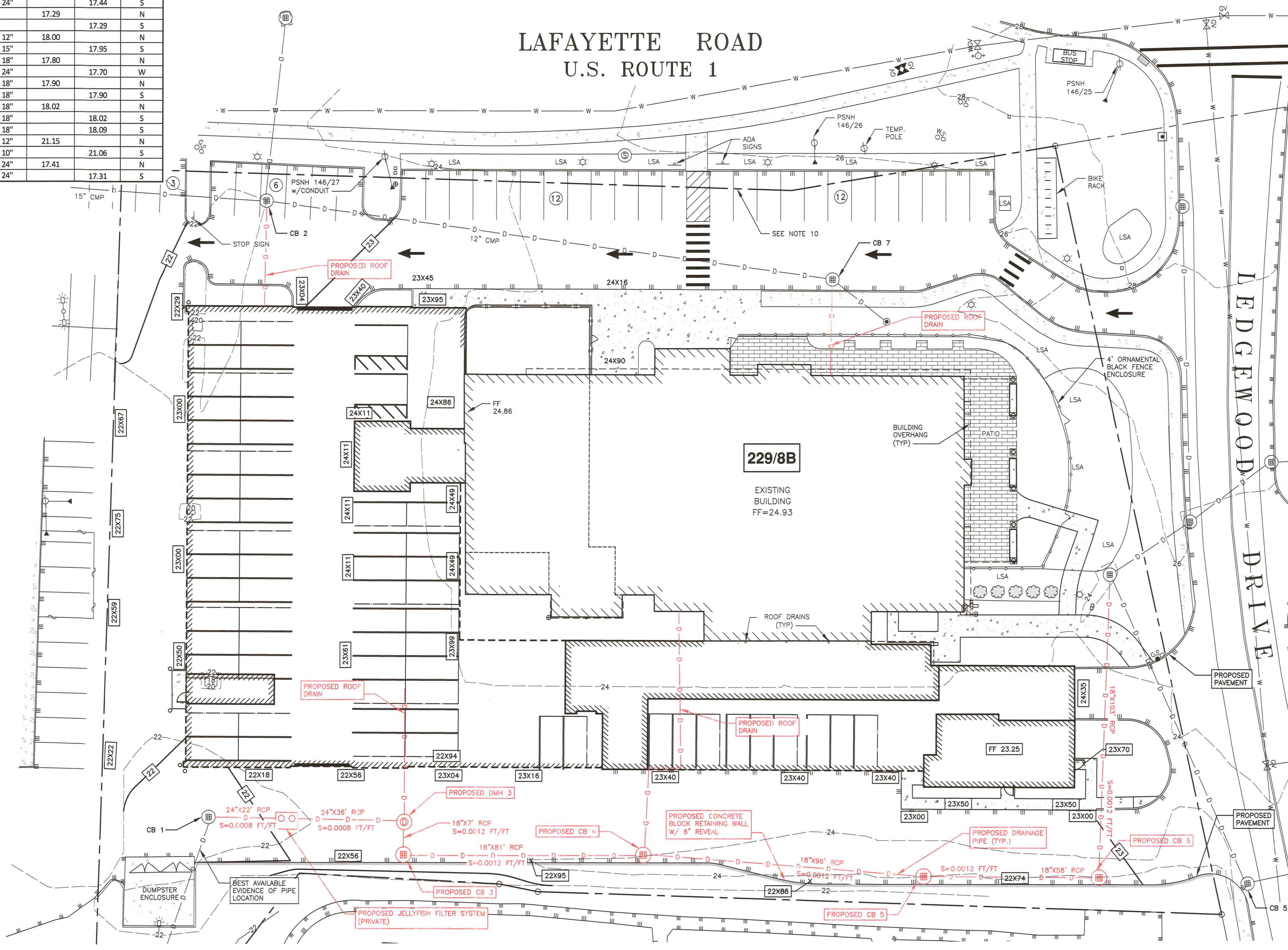

AMBIT ENGINEERING, INC.
A DIVISION OF HALEY WARD, INC.

200 Griffin Road, Unit 3
Portsmouth, NH 03801
603.430.9282

WWW.HALEYWARD.COM

- NOTES:**
- 1) THE CONTRACTOR SHALL NOTIFY DIG SAFE AT 1-888-DIG-SAFE (1-888-344-7233) AT LEAST 72 HOURS PRIOR TO COMMENCING ANY EXCAVATION ON PUBLIC OR PRIVATE PROPERTY WITHIN 100 FEET OF UNDERGROUND UTILITIES. THE EXCAVATOR IS RESPONSIBLE TO MAINTAIN MARKS. DIG SAFE TICKETS EXPIRE IN THIRTY DAYS.
 - 2) UNDERGROUND UTILITY LOCATIONS ARE BASED UPON BEST AVAILABLE EVIDENCE AND ARE NOT FIELD VERIFIED. LOCATING AND PROTECTING ANY ABOVEGROUND OR UNDERGROUND UTILITIES IS THE SOLE RESPONSIBILITY OF THE CONTRACTOR AND/OR THE OWNER. UTILITY CONFLICTS SHOULD BE REPORTED AT ONCE TO THE DESIGN ENGINEER.
 - 3) CONTRACTOR SHALL INSTALL AND MAINTAIN EROSION CONTROL MEASURES IN ACCORDANCE WITH THE "NEW HAMPSHIRE STORMWATER MANUAL, VOLUME 3, EROSION AND SEDIMENT CONTROLS DURING CONSTRUCTION. (NHDES DECEMBER 2008).

**COMMERCIAL DEVELOPMENT
581 LAFAYETTE ROAD
PORTSMOUTH, N.H.**

NO.	DESCRIPTION	DATE
2	GRADES	1/24/24
1	ISSUED FOR APPROVAL	11/20/23
0	ISSUED FOR COMMENT	2/7/23

REVISIONS

SCALE: 1"=20' JULY 2023

**GRADING DRAINAGE
EROSION CONTROL PLAN**

C6

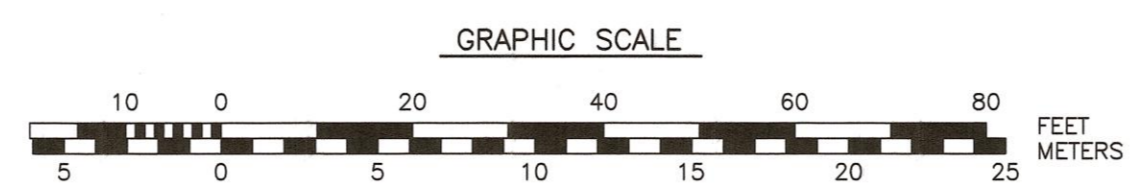

ASTM D 448 GRADATION TABLE

①		②		③	
ASTM No. 8 BEDDING & JOINT FILLER		ASTM No. 57 STONE OPEN GRADED BASE		ASTM No. 2 STONE SUBBASE	
SIEVE SIZE	PASSING BY WEIGHT (%)	SIEVE SIZE	PASSING BY WEIGHT (%)	SIEVE SIZE	PASSING BY WEIGHT (%)
1/2" (12.5mm)	100	1.5" (37.5mm)	100	3" (75mm)	100
3/8" (9.5mm)	85-100	1" (25mm)	95-100	2.5" (63mm)	90-100
No. 4 (4.75mm)	10-30	1/2" (12.5mm)	25-60	2" (50mm)	35-70
No. 8 (2.36mm)	0-10	No. 4 (4.75mm)	0-10	1.5" (37.5mm)	0-15
No. 16 (1.16mm)	0-5	No. 8 (2.36mm)	0-5	3/4" (19mm)	0-5

- NOTES:
- 1) PAVING SYSTEM BASE DESIGN IS SIMILAR TO BASE REQUIRED FOR THE UNI ECO-STONE PAVER. INSTALLATION SHALL FOLLOW MANUFACTURER'S INSTRUCTIONS FOR PLACEMENT OF BASE MATERIALS.
 - 2) ALL STONE SHALL BE ANGULAR, WITH 90% FRACTURED FACES. STONE SHALL BE WASHED WITH LESS THAN 1% PASSING THE 200 SIEVE.
 - 3) CONTRACTOR SHALL SUBMIT SIEVE ANALYSIS FOR EACH COURSE MATERIAL TO PROJECT ENGINEER FOR APPROVAL PRIOR TO PLACEMENT.
 - 4) ALL FABRIC TO BE TENCATE MIRAFI 140N NONWOVEN GEOTEXTILE.

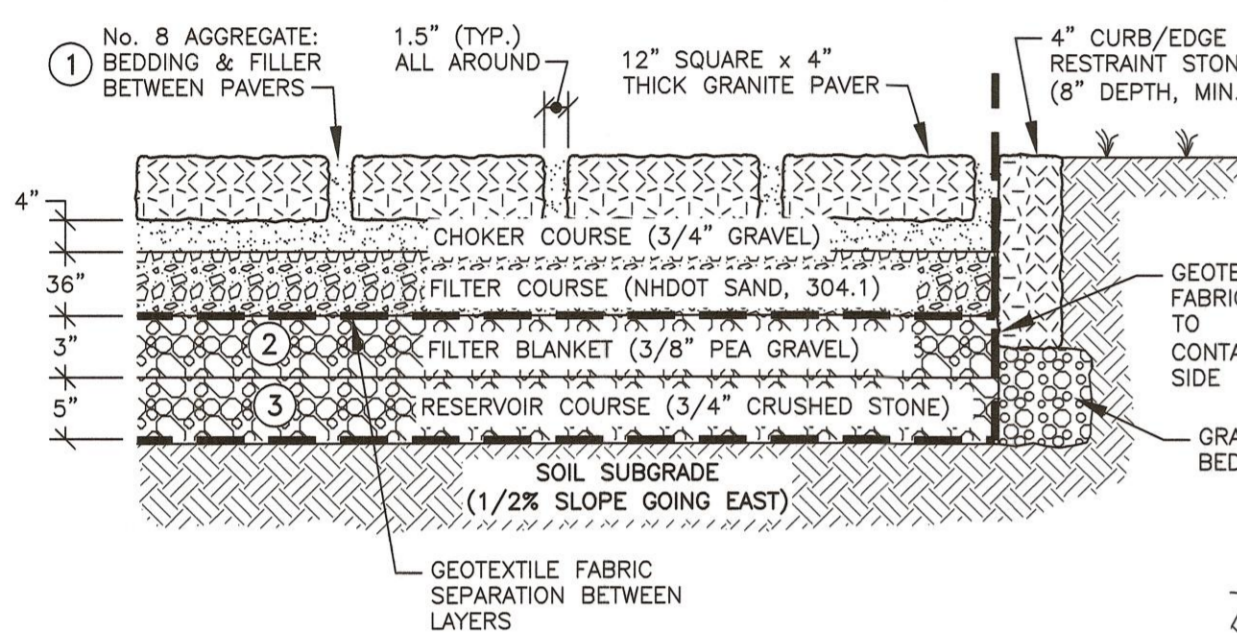

A POROUS PATIO SECTION
C7 12" SQUARE GRANITE PAVERS OR APPROVED EQUAL NTS

OPEN SPACE
OPEN SPACE 16,911 S.F.
LOT AREA 98,124 S.F.
REQUIRED OPEN SPACE: 20%
ALLOWED OPEN SPACE PER VARIANCE: 16.2%
PROVIDED OPEN SPACE: 17.2% (NON-CONFORMING)
NON-CONFORMING (EXPANSION)
REQUEST TO ALLOW 17.2% OPEN SPACE (SECTION 10.5B52)

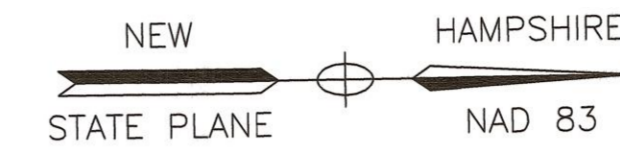

LAFAYETTE ROAD
U.S. ROUTE 1

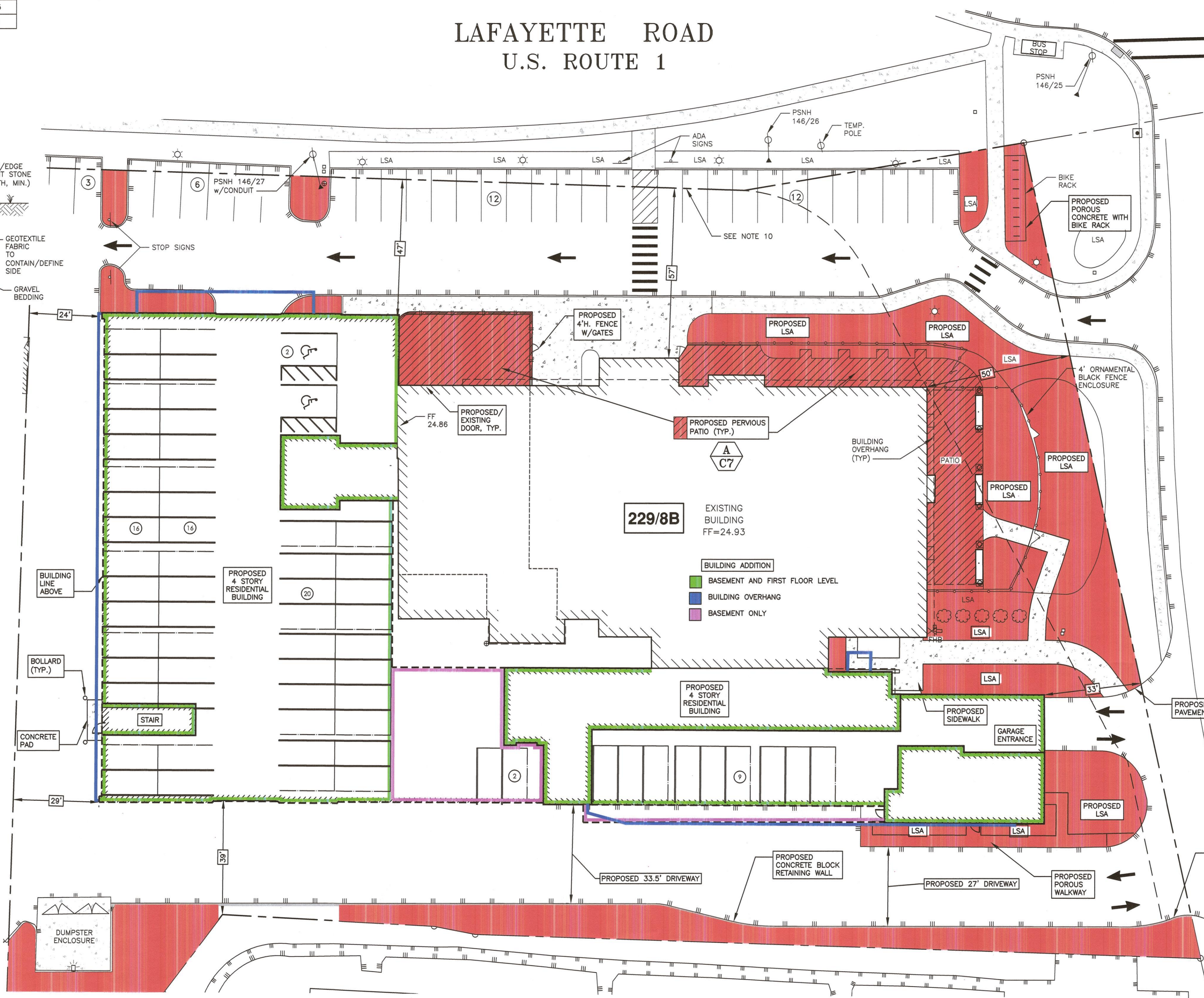

- NOTES:**
- 1) PARCEL IS SHOWN ON THE CITY OF PORTSMOUTH ASSESSOR'S MAP 229 AS LOT 8B.
 - 2) OWNERS OF RECORD:
ATLAS COMMONS, LLC
3 PLEASANT STREET, SUITE 400
PORTSMOUTH, NH 03801
6474/1538
 - 3) THE PARCEL IS NOT IN A FLOOD HAZARD ZONE AS SHOWN ON FIRM PANEL 33015C0270E, EFFECTIVE MAY 17, 2005
 - 4) EXISTING LOT AREA:
98,124 S.F.
2.2526 AC
 - 5) PARCEL IS LOCATED IN THE GATEWAY NEIGHBORHOOD CORRIDOR (G1) DISTRICT.
 - 6) DIMENSIONAL REQUIREMENTS:
SEE ZONING ORDINANCE SECTION 10.5B22.10
 - 7) THE PURPOSE OF THIS PLAN IS TO SHOW THE OPEN SPACE ON TAX MAP 229 LOT 8B.

COMMERCIAL DEVELOPMENT
581 LAFAYETTE ROAD
PORTSMOUTH, N.H.

NO.	DESCRIPTION	DATE
1	OPEN SPACE	1/2/24
0	ISSUED FOR COMMENT	12/19/23



SCALE: 1"=20' JULY 2023

OPEN SPACE PLAN **C7**

APPROVED BY THE PORTSMOUTH PLANNING BOARD

CHAIRMAN _____ DATE _____

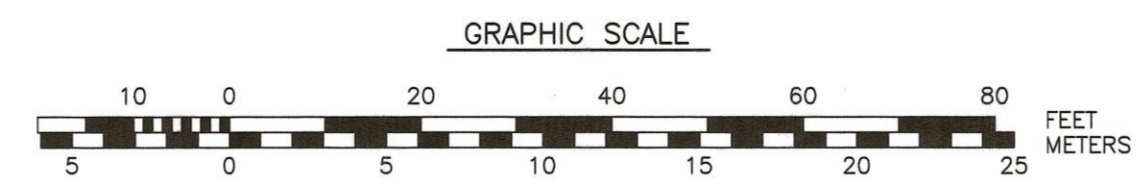

NOTES:

- 1) PARCEL IS SHOWN ON THE CITY OF PORTSMOUTH ASSESSOR'S MAP 229 AS LOT 8B.
- 2) OWNERS OF RECORD:
ATLAS COMMONS, LLC
3 PLEASANT STREET, SUITE 400
PORTSMOUTH, NH 03801
6474/1538
- 3) THE PARCEL IS NOT IN A FLOOD HAZARD ZONE AS SHOWN ON FIRM PANEL 33015C0270F, EFFECTIVE JANUARY 29, 2021
- 4) EXISTING LOT AREA:
98,124 S.F.
2.2526 AC
- 5) PARCEL IS LOCATED IN THE GATEWAY NEIGHBORHOOD CORRIDOR (G1) DISTRICT.
- 6) DIMENSIONAL REQUIREMENTS:
SEE ZONING ORDINANCE SECTION 10.5B22.10
- 7) THE PURPOSE OF THIS PLAN IS TO SHOW THE COMMUNITY SPACE ON TAX MAP 229 LOT 8B.

LAFAYETTE ROAD
U.S. ROUTE 1

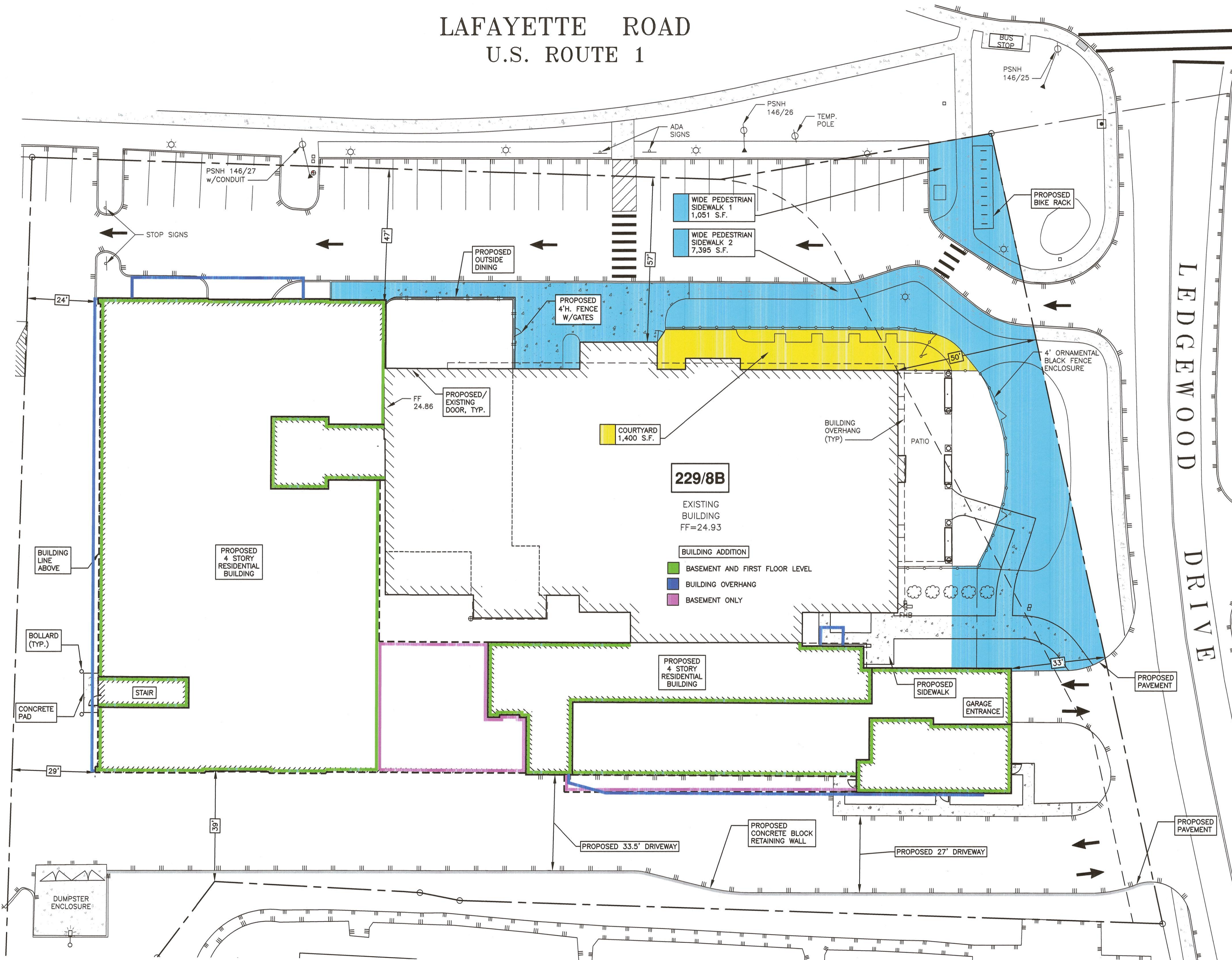

COMMUNITY SPACE

WIDE PEDESTRIAN SIDEWALK 1 = 1,051 S.F.
WIDE PEDESTRIAN SIDEWALK 2 = 7,395 S.F.
COURTYARD = 1,400 S.F.
PROPOSED COMMUNITY SPACE 9,846 S.F.
LOT AREA 98,124 S.F.

COMMUNITY SPACE REQUIRED: 10%
(PER SECTION 10.5B41.80.2)
COMMUNITY SPACE PROVIDED: 10.0%

COMMUNITY SPACE USES
(PER SECTION 10.5B102)

PROPOSED USES: WIDE PEDESTRIAN SIDEWALK
COURTYARD

229/8B

EXISTING BUILDING
FF=24.93

BUILDING ADDITION

- BASEMENT AND FIRST FLOOR LEVEL
- BUILDING OVERHANG
- BASEMENT ONLY

COMMERCIAL DEVELOPMENT
581 LAFAYETTE ROAD
PORTSMOUTH, N.H.

NO.	DESCRIPTION	DATE
1	AREAS/TYPES	1/24/24
0	ISSUED FOR COMMENT	12/19/23

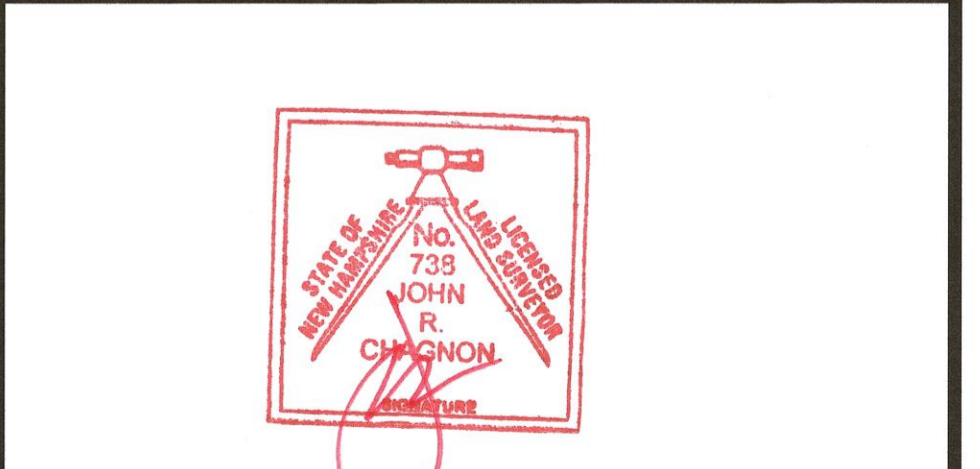

SCALE: 1"=20' JULY 2023

COMMUNITY SPACE PLAN **C8**

APPROVED BY THE PORTSMOUTH PLANNING BOARD

CHAIRMAN _____ DATE _____

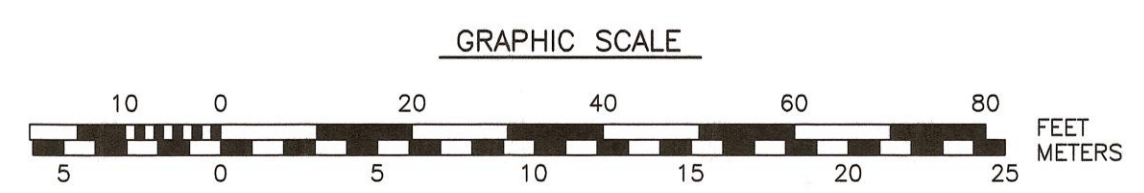

PUBLIC REALM

PUBLIC REALM IMPROVEMENT (PER SECTION 10.5B73.20.1)
 LINEAR STREET FRONTAGE OF SITE: 619 FT
 PROPOSED TRAIL NETWORK LENGTH: 622 FT

REQUIRED LENGTH: 619 FT
 PROVIDED LENGTH: 622 FT

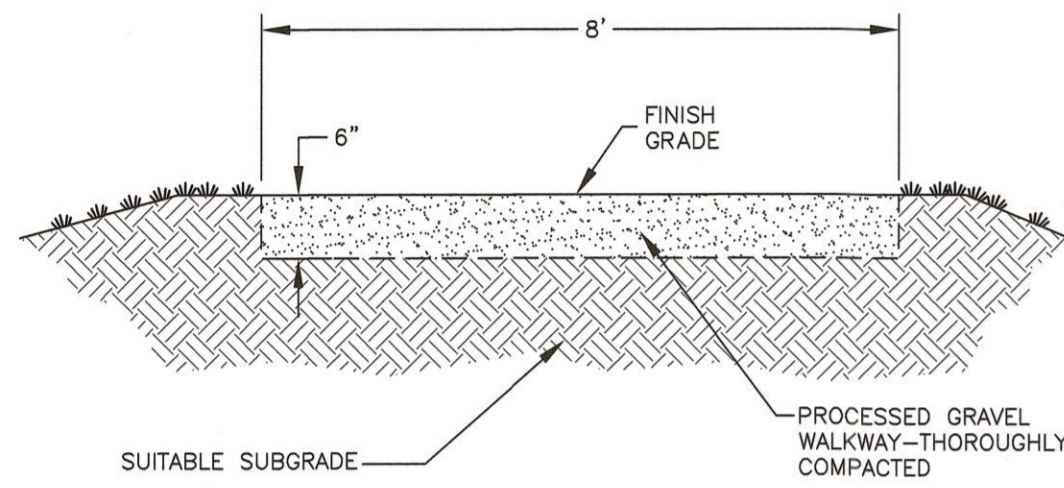

1 GRAVEL PATH
 C9 NTS

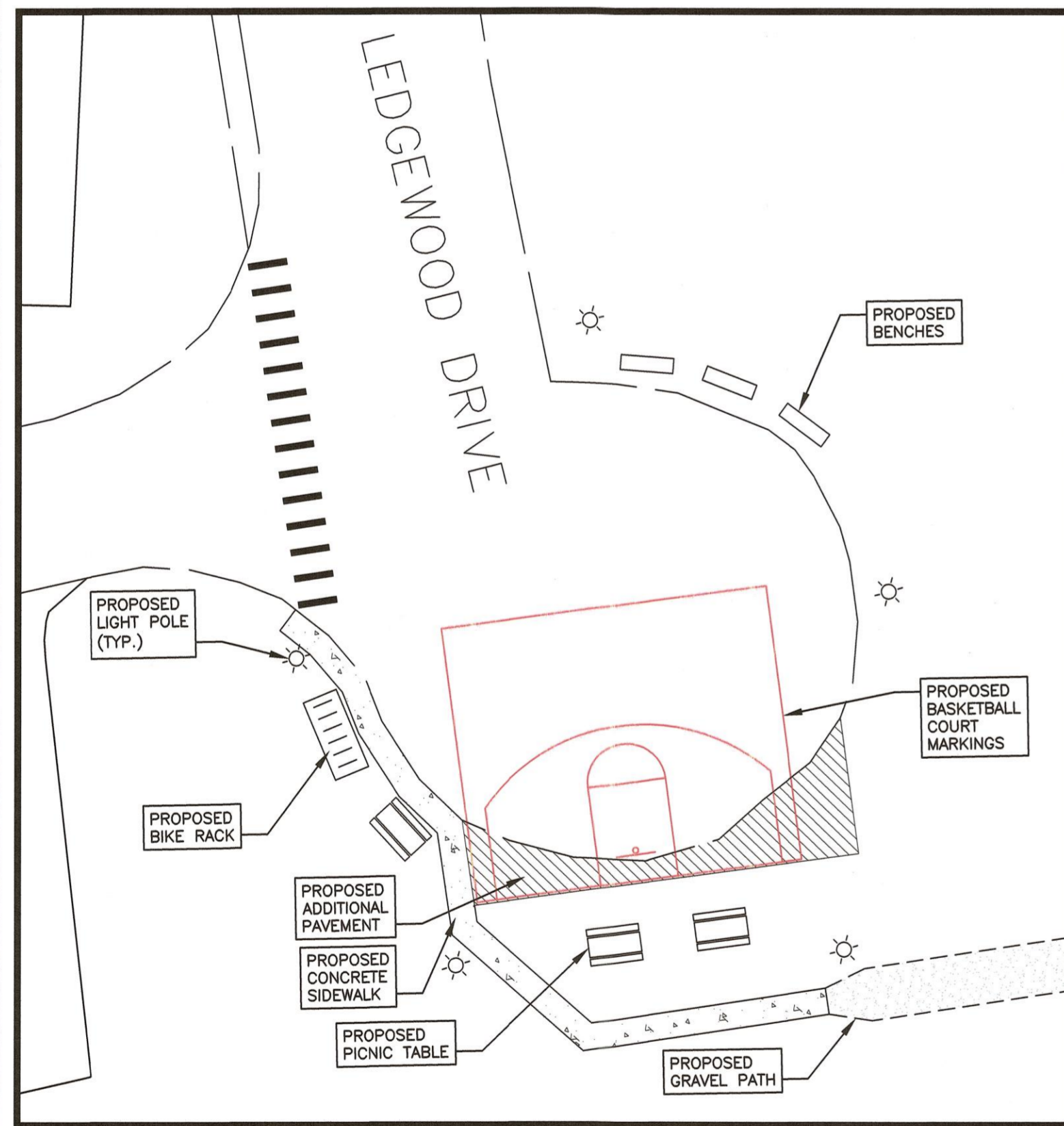

2 LEDGEWOOD IMPROVEMENTS
 C9 NTS

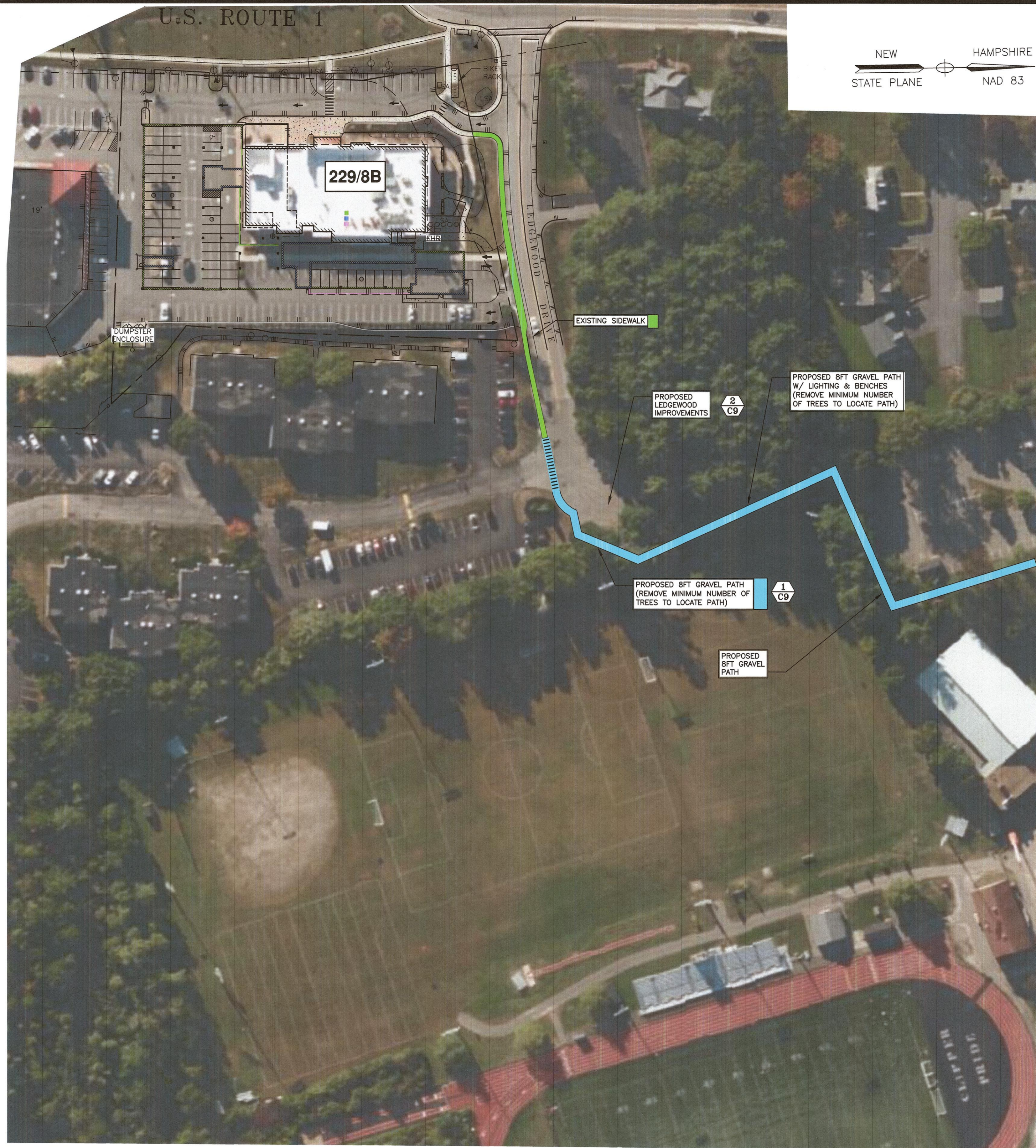
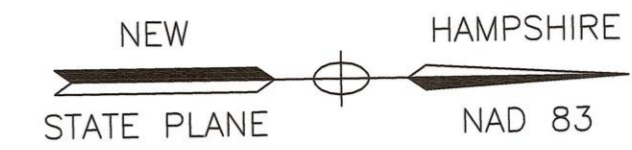
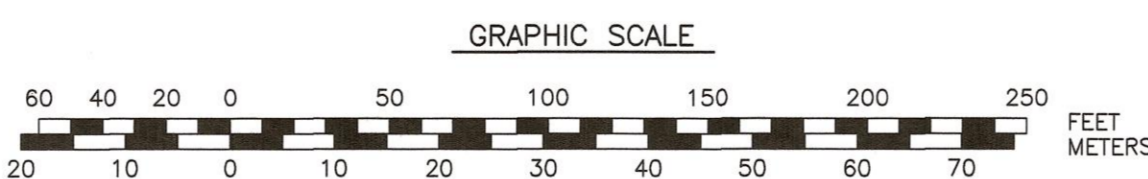
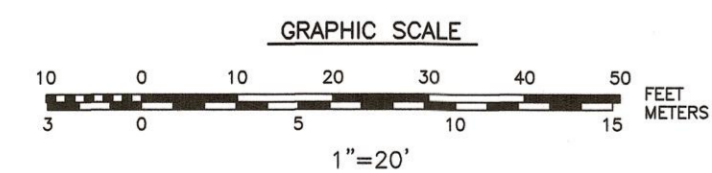

NOTES:

- 1) PARCEL IS SHOWN ON THE CITY OF PORTSMOUTH ASSESSOR'S MAP 229 AS LOT 8B.
- 2) OWNERS OF RECORD:
 ATLAS COMMONS, LLC
 3 PLEASANT STREET, SUITE 400
 PORTSMOUTH, NH 03801
 6474/1538
- 3) THE PARCEL IS NOT IN A FLOOD HAZARD ZONE AS SHOWN ON FIRM PANEL 33015C0270E, EFFECTIVE MAY 17, 2005
- 4) EXISTING LOT AREA:
 98,124 S.F.
 2.2526 AC
- 5) PARCEL IS LOCATED IN THE GATEWAY NEIGHBORHOOD CORRIDOR (G1) DISTRICT.
- 6) DIMENSIONAL REQUIREMENTS:
 SEE ZONING ORDINANCE SECTION 10.5B22.10
- 7) THE PURPOSE OF THIS PLAN IS TO SHOW PUBLIC REALM IN ACCORDANCE WITH SECTION 10.5B7320.1 ON TAX MAP 229 LOT 8B.
- 8) PUBLIC REALM IMPROVEMENTS SHOWN HEREON ARE SUBJECT TO CITY OF PORTSMOUTH SCHOOL DEPARTMENT REVIEW AND APPROVAL. FINAL DESIGN & LOCATION TO BE DETERMINED.
- 9) TOPOGRAPHY FROM LIDAR.

COMMERCIAL DEVELOPMENT
581 LAFAYETTE ROAD
PORTSMOUTH, N.H.

NO.	DESCRIPTION	DATE
0	ISSUED FOR COMMENT	1/4/24

REVISIONS		

SCALE: 1"=60' january 2024

PUBLIC REALM PLAN

C9

CONCEPT

PUBLIC REALM

PUBLIC REALM IMPROVEMENT (PER SECTION 10.5B73.20.1)
 LINEAR STREET FRONTAGE OF SITE: 619 FT
 PROPOSED TRAIL NETWORK LENGTH: 622 FT

REQUIRED LENGTH: 619 FT
 PROVIDED LENGTH: 622 FT

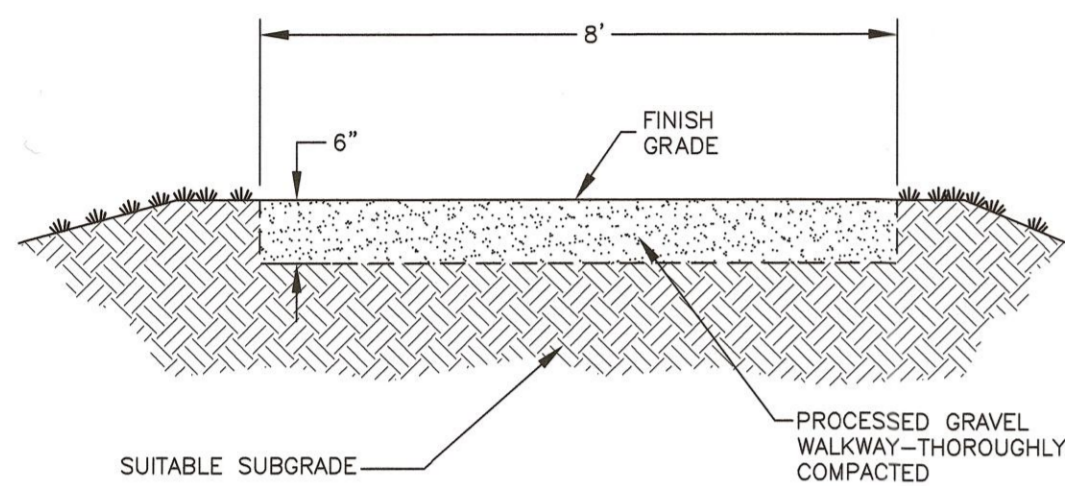

1 GRAVEL PATH
 NTS

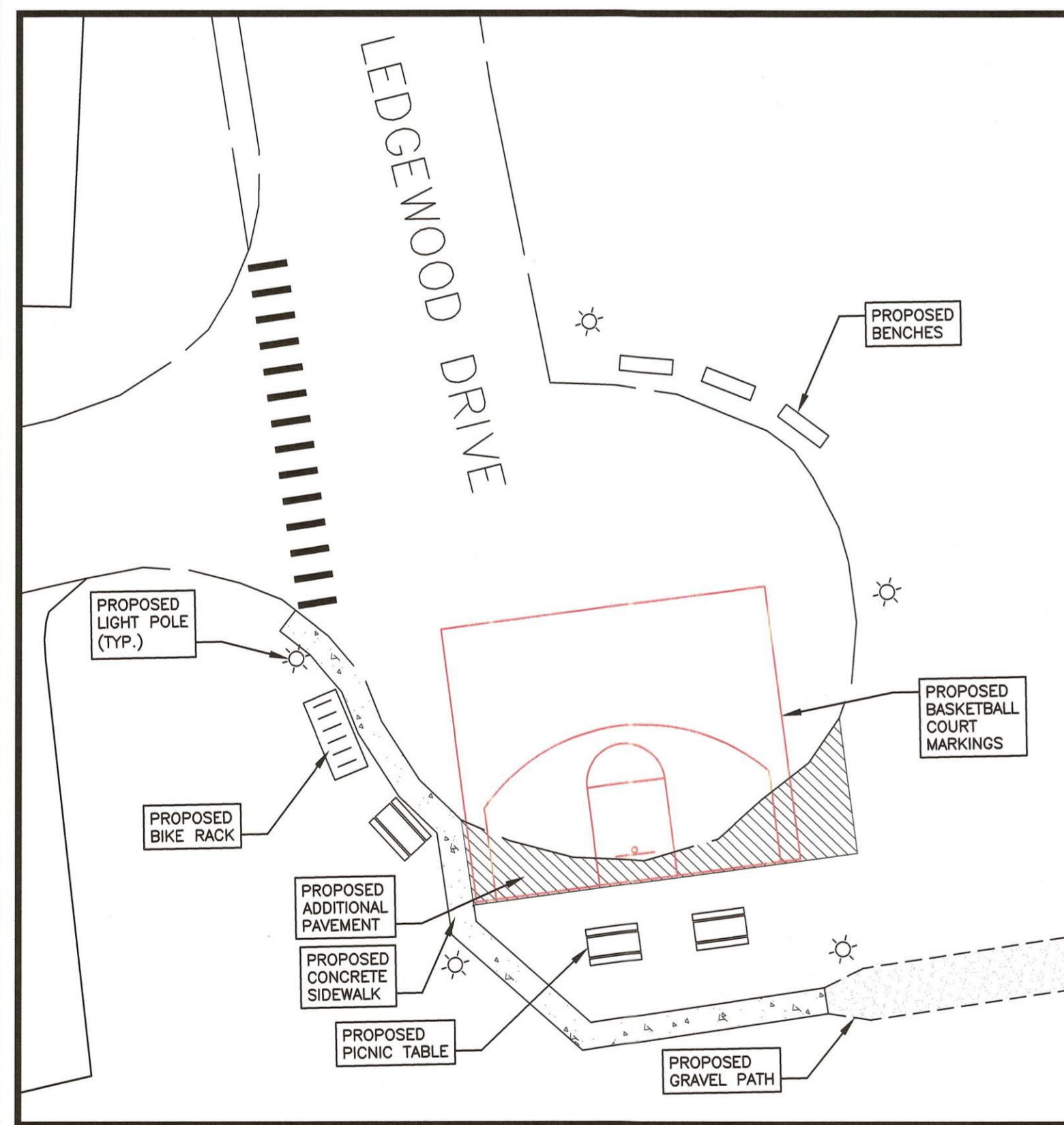

2 LEDGEWOOD IMPROVEMENTS
 NTS

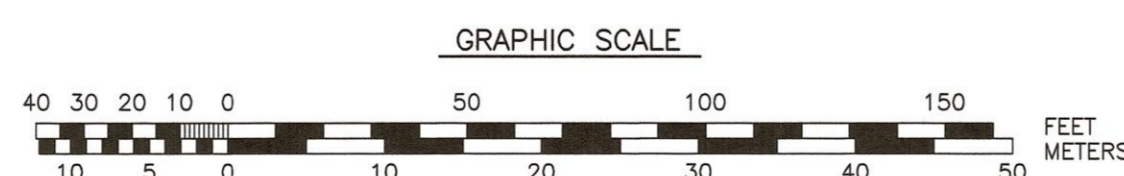
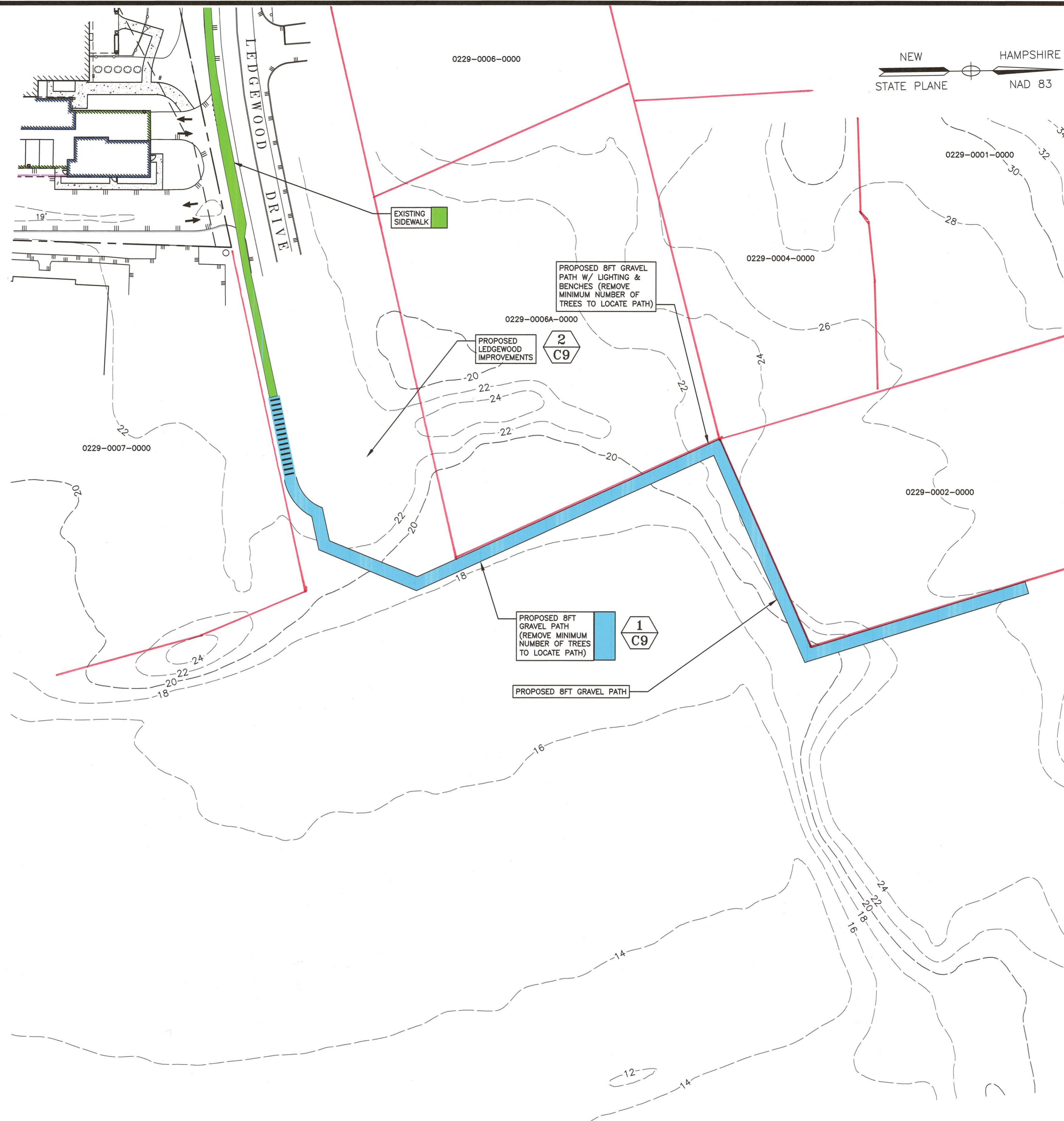
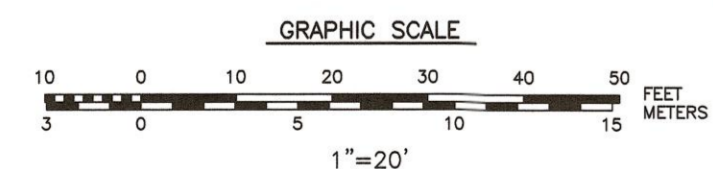

NEW HAMPSHIRE
 STATE PLANE NAD 83

NOTES:

- 1) PARCEL IS SHOWN ON THE CITY OF PORTSMOUTH ASSESSOR'S MAP 229 AS LOT 8B.
- 2) OWNERS OF RECORD:
 ATLAS COMMONS, LLC
 3 PLEASANT STREET, SUITE 400
 PORTSMOUTH, NH 03801
 6474/1538
- 3) THE PARCEL IS NOT IN A FLOOD HAZARD ZONE AS SHOWN ON FIRM PANEL 33015C0270E, EFFECTIVE MAY 17, 2005
- 4) EXISTING LOT AREA:
 98,124 S.F.
 2.2526 AC
- 5) PARCEL IS LOCATED IN THE GATEWAY NEIGHBORHOOD CORRIDOR (G1) DISTRICT.
- 6) DIMENSIONAL REQUIREMENTS:
 SEE ZONING ORDINANCE SECTION 10.5B22.10
- 7) THE PURPOSE OF THIS PLAN IS TO SHOW PUBLIC REALM IN ACCORDANCE WITH SECTION 10.5B7320.1 ON TAX MAP 229 LOT 8B.
- 8) PUBLIC REALM IMPROVEMENTS SHOWN HEREON ARE SUBJECT TO CITY OF PORTSMOUTH SCHOOL DEPARTMENT REVIEW AND APPROVAL. FINAL DESIGN & LOCATION TO BE DETERMINED.
- 9) TOPOGRAPHY FROM LIDAR.

COMMERCIAL DEVELOPMENT
581 LAFAYETTE ROAD
PORTSMOUTH, N.H.

NO.	DESCRIPTION	DATE
0	ISSUED FOR COMMENT	1/4/24

REVISIONS

SCALE: 1"=40' JANUARY 2024

PUBLIC REALM PLAN

C10

CONCEPT

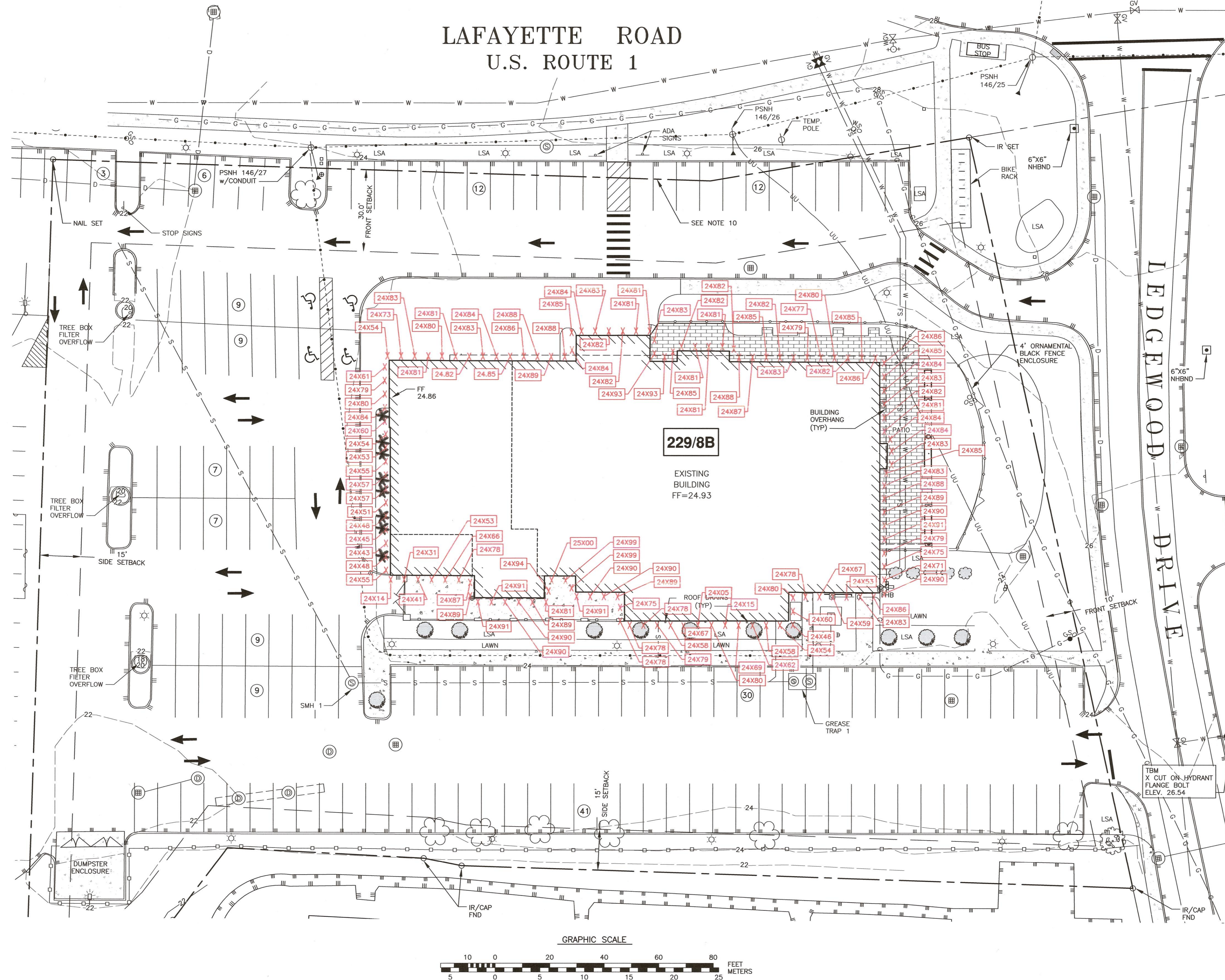

NOTES:

- 1) THE CONTRACTOR SHALL NOTIFY DIG SAFE AT 1-888-DIG-SAFE (1-888-344-7233) AT LEAST 72 HOURS PRIOR TO COMMENCING ANY EXCAVATION ON PUBLIC OR PRIVATE PROPERTY WITHIN 100 FEET OF UNDERGROUND UTILITIES. THE EXCAVATOR IS RESPONSIBLE TO MAINTAIN MARKS. DIG SAFE TICKETS EXPIRE IN THIRTY DAYS.
- 2) UNDERGROUND UTILITY LOCATIONS ARE BASED UPON BEST AVAILABLE EVIDENCE AND ARE NOT FIELD VERIFIED. LOCATING AND PROTECTING ANY ABOVEGROUND OR UNDERGROUND UTILITIES IS THE SOLE RESPONSIBILITY OF THE CONTRACTOR AND/OR THE OWNER. UTILITY CONFLICTS SHOULD BE REPORTED AT ONCE TO THE DESIGN ENGINEER.
- 3) CONTRACTOR SHALL INSTALL AND MAINTAIN EROSION CONTROL MEASURES IN ACCORDANCE WITH THE "NEW HAMPSHIRE STORMWATER MANUAL, VOLUME 3, EROSION AND SEDIMENT CONTROLS DURING CONSTRUCTION. (NHDES DECEMBER 2008).
- 4) VERTICAL DATUM IS NAVD88. BASIS OF VERTICAL DATUM IS REDUNDANT RTN GNSS OBSERVATIONS.

COMMERCIAL DEVELOPMENT
581 LAFAYETTE ROAD
PORTSMOUTH, N.H.

NO.	DESCRIPTION	DATE
0	ISSUED FOR COMMENT	1/18/24

REVISIONS

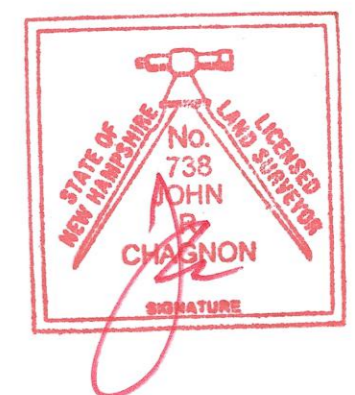

SCALE: 1"=20' DECEMBER 2023

EXISTING AVERAGE GRADE PLANE **C11**

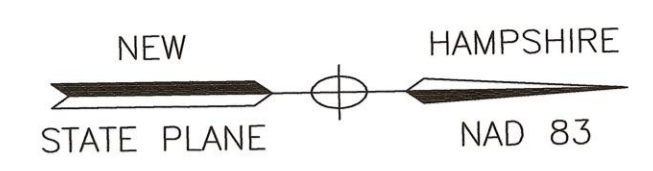

**LAFAYETTE ROAD
U.S. ROUTE 1**

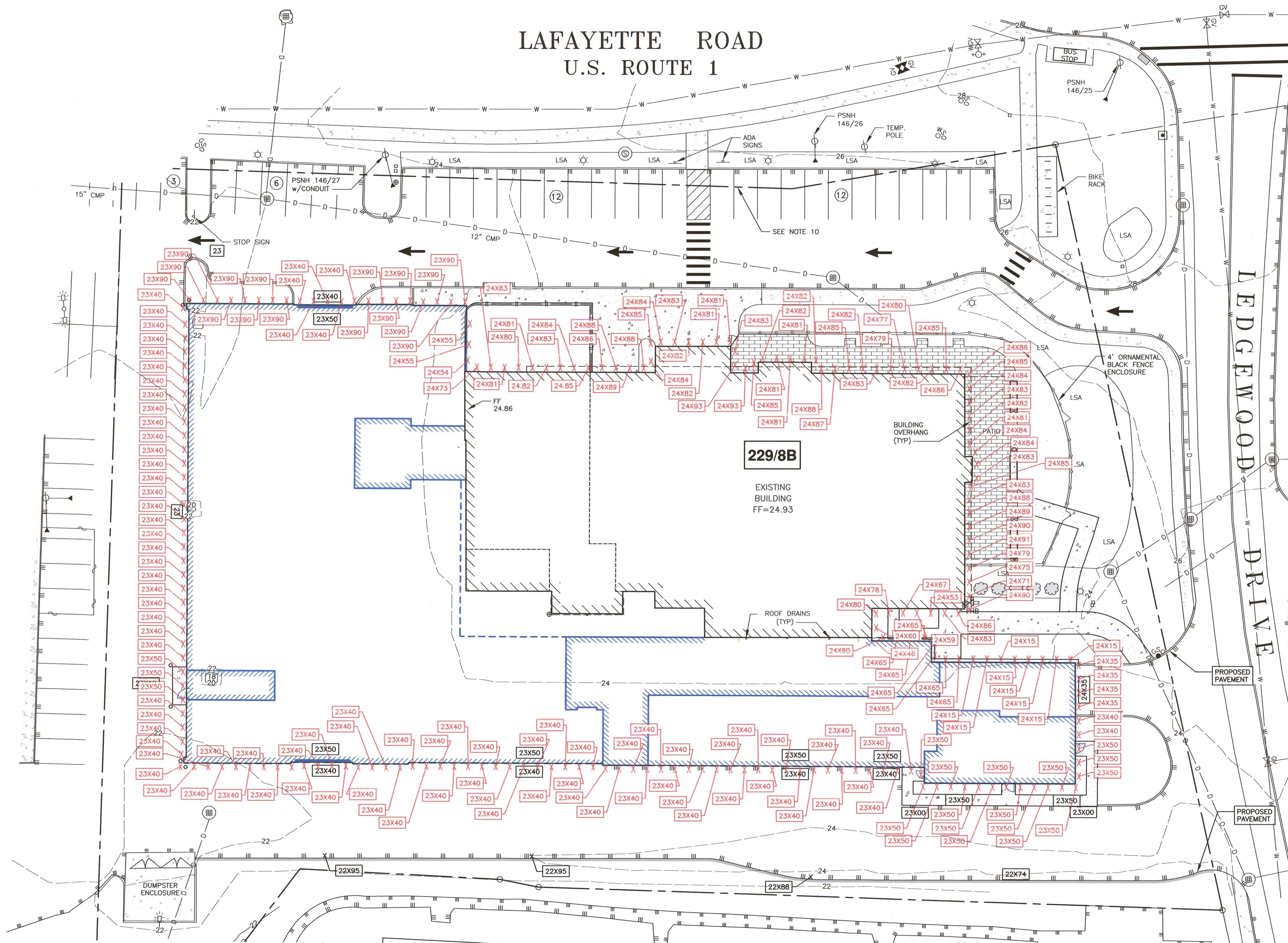

NOTES:

- 1) THE CONTRACTOR SHALL NOTIFY DIG SAFE AT 1-888-DIG-SAFE (1-888-344-7233) AT LEAST 72 HOURS PRIOR TO COMMENCING ANY EXCAVATION ON PUBLIC OR PRIVATE PROPERTY WITHIN 100 FEET OF UNDERGROUND UTILITIES. THE EXCAVATOR IS RESPONSIBLE TO MAINTAIN MARKS. DIG SAFE TICKETS EXPIRE IN THIRTY DAYS.
- 2) UNDERGROUND UTILITY LOCATIONS ARE BASED UPON BEST AVAILABLE EVIDENCE AND ARE NOT FIELD VERIFIED. LOCATING AND PROTECTING ANY ABOVEGROUND OR UNDERGROUND UTILITIES IS THE SOLE RESPONSIBILITY OF THE CONTRACTOR AND/OR THE OWNER. UTILITY CONFLICTS SHOULD BE REPORTED AT ONCE TO THE DESIGN ENGINEER.
- 3) CONTRACTOR SHALL INSTALL AND MAINTAIN EROSION CONTROL MEASURES IN ACCORDANCE WITH THE "NEW HAMPSHIRE STORMWATER MANUAL, VOLUME 3, EROSION AND SEDIMENT CONTROLS DURING CONSTRUCTION. (NHDES DECEMBER 2008).
- 4) VERTICAL DATUM IS NAVD88. BASIS OF VERTICAL DATUM IS REDUNDANT RTN GNSS OBSERVATIONS.

**COMMERCIAL DEVELOPMENT
581 LAFAYETTE ROAD
PORTSMOUTH, N.H.**

0	ISSUED FOR COMMENT	1/11/24
NO.	DESCRIPTION	DATE



SCALE: 1"=20' DECEMBER 2023

PROPOSED AVERAGE GRADE PLANE **C12**

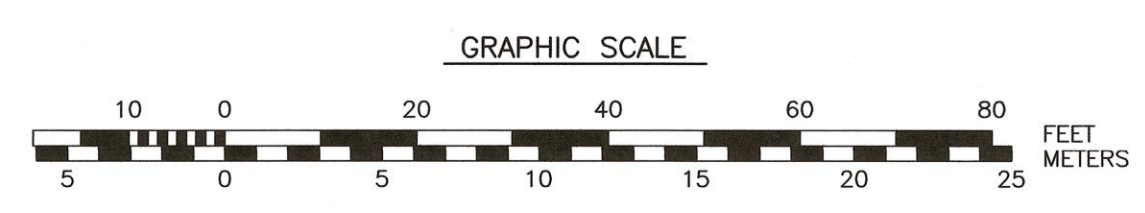

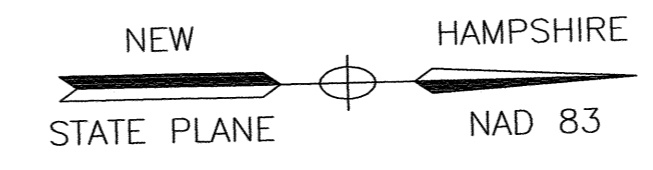

LAFAYETTE ROAD
U.S. ROUTE 1

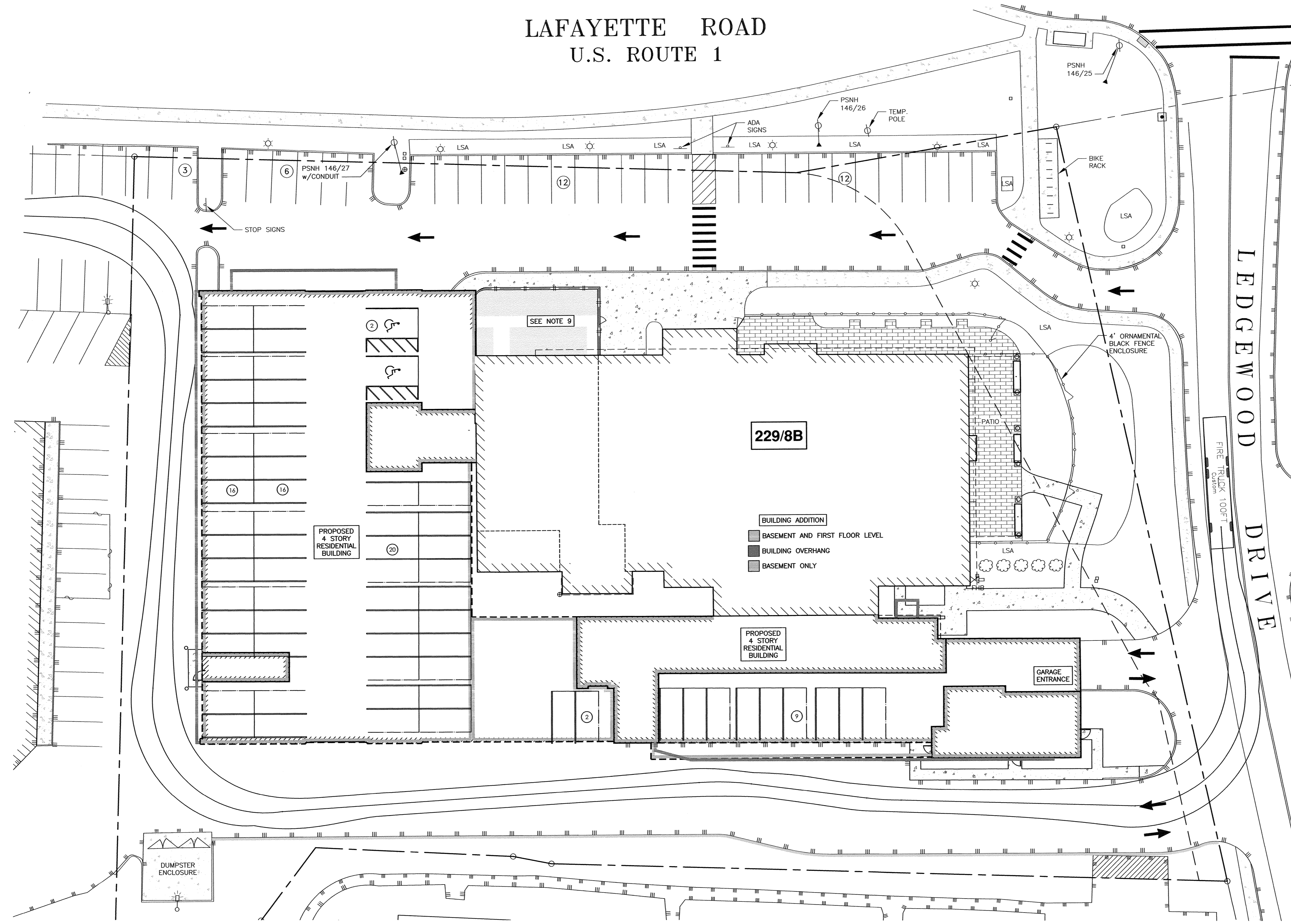

NOTES:

- 1) PARCEL IS SHOWN ON THE CITY OF PORTSMOUTH ASSESSOR'S MAP 229 AS LOT 8B.
- 2) OWNERS OF RECORD:
ATLAS COMMONS, LLC
3 PLEASANT STREET, SUITE 400
PORTSMOUTH, NH 03801
6474/1538
- 3) THE PARCEL IS NOT IN A FLOOD HAZARD ZONE AS SHOWN ON FIRM PANEL 33015C0270E, EFFECTIVE MAY 17, 2005
- 4) EXISTING LOT AREA:
98,124 S.F.
2.2526 AC
- 5) PARCEL IS LOCATED IN THE GATEWAY CORRIDOR (G1) DISTRICT.
- 6) DIMENSIONAL REQUIREMENTS:
SEE ZONING ORDINANCE SECTION 10.5B22.10
- 7) THE PURPOSE OF THIS PLAN IS TO SHOW GENERAL TURNING MOVEMENTS ON TAX MAP 229 LOT 8B.
- 8) DESIGN BASED ON ARCHITECTURAL PLAN BY ARCOVE ARCHITECTS DATED 8/22/23.
- 9) CONVERSION OF TUSCAN MARKETPLACE TO RESTAURANT (NORTHEASTERN THAI, LLC) APPROVED UNDER PERMIT: LU-22-254

COMMERCIAL DEVELOPMENT
581 LAFAYETTE ROAD
PORTSMOUTH, N.H.

NO.	DESCRIPTION	DATE
1	ISSUED FOR APPROVAL	1/24/24
0	ISSUED FOR COMMENT	8/31/23

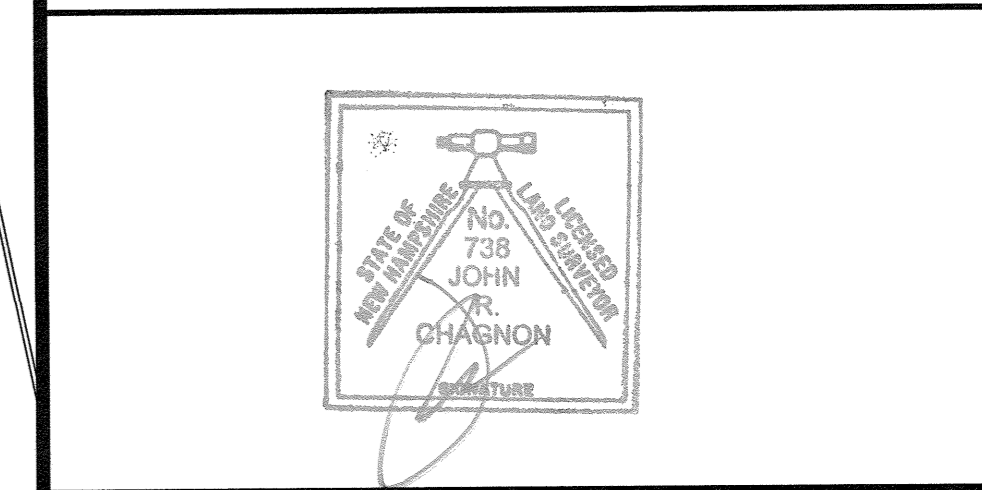

SCALE: 1"=20' JULY 2023

FIRE TRUCK TURNING PLAN **T1**

APPROVED BY THE PORTSMOUTH PLANNING BOARD

CHAIRMAN _____ DATE _____

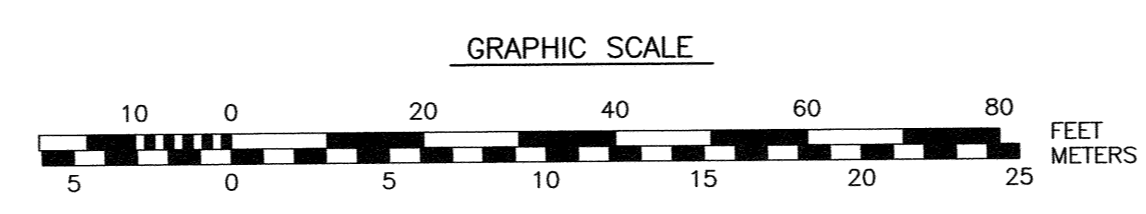

P:\NH\051516_Macys\Projects\1397.04 Lafayette Rd. Portsmouth\1397.04_DISTING 2023.dwg 1/24/24 10:53:34 PM, Appointed: Home-Care\T1300028.dwg

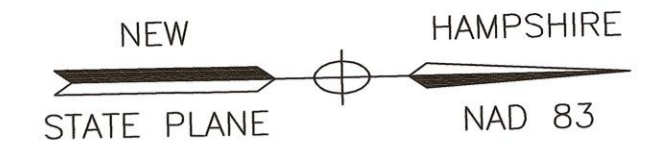

LAFAYETTE ROAD
U.S. ROUTE 1

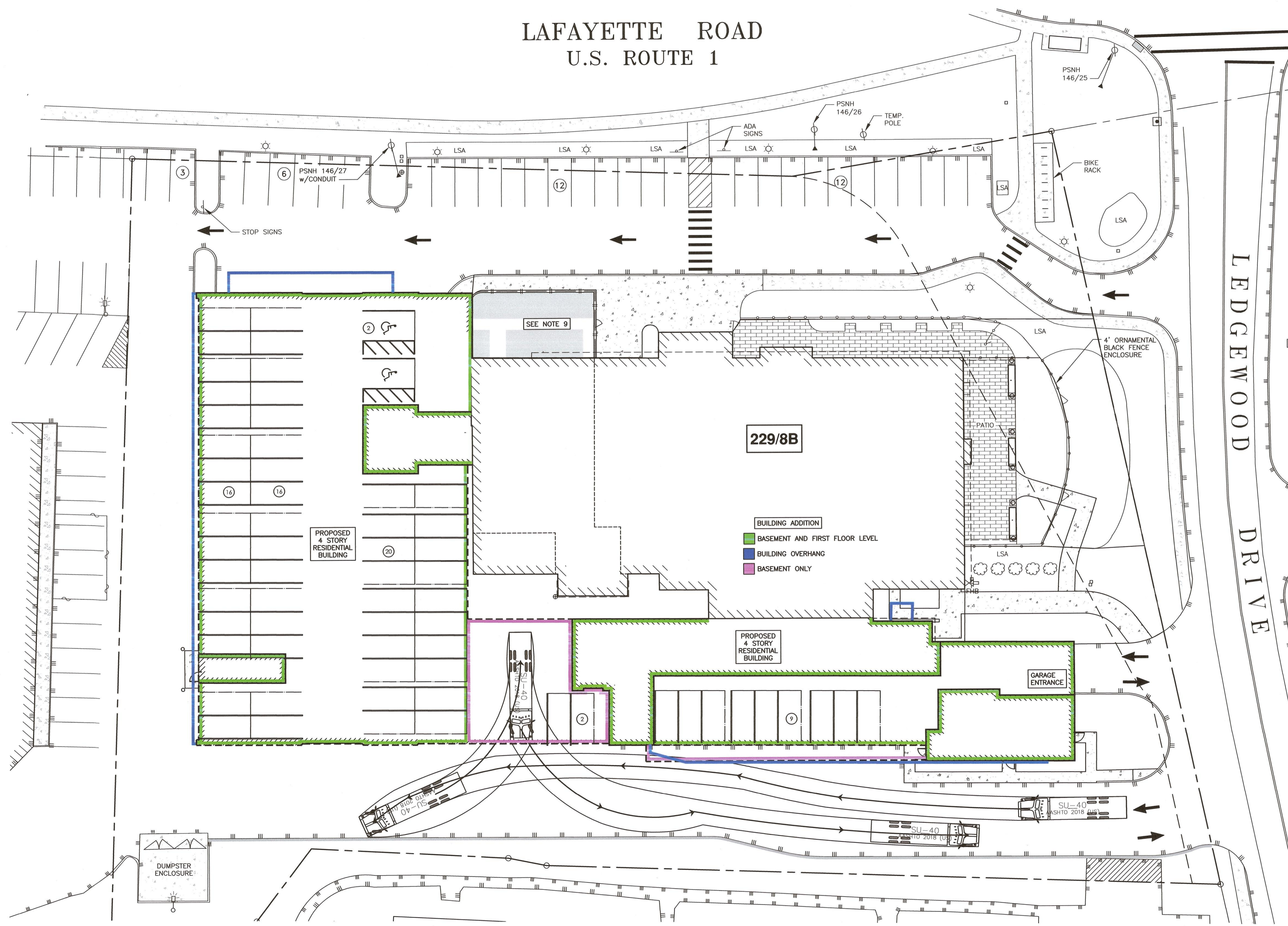

NOTES:

- 1) PARCEL IS SHOWN ON THE CITY OF PORTSMOUTH ASSESSOR'S MAP 229 AS LOT 8B.
- 2) OWNERS OF RECORD:
ATLAS COMMONS, LLC
3 PLEASANT STREET, SUITE 400
PORTSMOUTH, NH 03801
6474/1538
- 3) THE PARCEL IS NOT IN A FLOOD HAZARD ZONE AS SHOWN ON FIRM PANEL 33015C0270E, EFFECTIVE MAY 17, 2005
- 4) EXISTING LOT AREA:
98,124 S.F.
2.2526 AC
- 5) PARCEL IS LOCATED IN THE GATEWAY CORRIDOR (G1) DISTRICT.
- 6) DIMENSIONAL REQUIREMENTS:
SEE ZONING ORDINANCE SECTION 10.5B22.10
- 7) THE PURPOSE OF THIS PLAN IS TO SHOW GENERAL TURNING MOVEMENTS ON TAX MAP 229 LOT 8B.
- 8) DESIGN BASED ON ARCHITECTURAL PLAN BY ARCOVE ARCHITECTS DATED 8/22/23.
- 9) CONVERSION OF TUSCAN MARKETPLACE TO RESTAURANT (NORTHEASTERN THAI, LLC) APPROVED UNDER PERMIT: LU-22-254

COMMERCIAL DEVELOPMENT
581 LAFAYETTE ROAD
PORTSMOUTH, N.H.

NO.	DESCRIPTION	DATE
1	ISSUED FOR APPROVAL	1/24/24
0	ISSUED FOR COMMENT	8/31/23

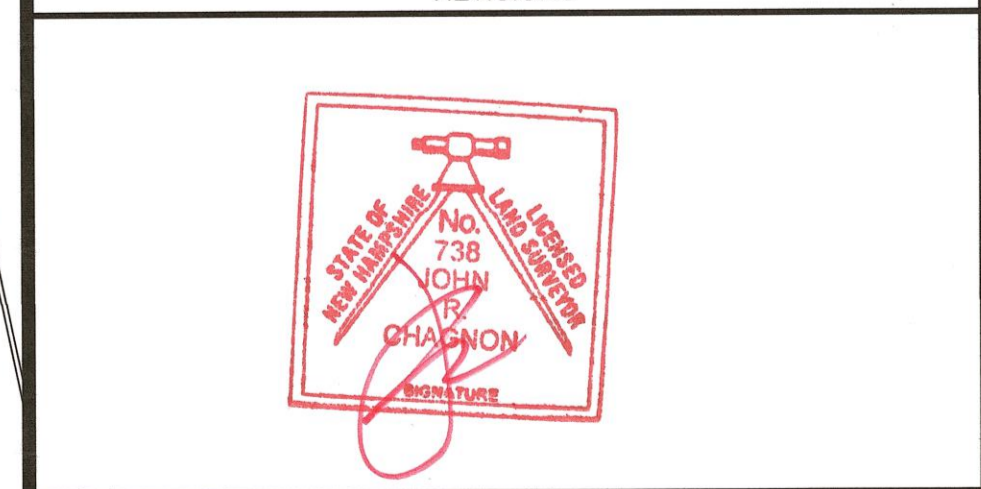

SCALE: 1"=20' JULY 2023

DELIVERY TRUCK TURNING PLAN **T2**

APPROVED BY THE PORTSMOUTH PLANNING BOARD

CHAIRMAN _____ DATE _____

EROSION CONTROL NOTES

CONSTRUCTION SEQUENCE

- DO NOT BEGIN CONSTRUCTION UNTIL ALL LOCAL, STATE AND FEDERAL PERMITS HAVE BEEN APPLIED FOR AND RECEIVED.
- THE CONTRACTOR SHALL OBTAIN AN NPDES PHASE II STORMWATER PERMIT BEFORE BEGINNING CONSTRUCTION AND SHALL HAVE ON SITE A STORMWATER POLLUTION PREVENTION PLAN (S.W.P.P.P.) AVAILABLE FOR INSPECTION BY THE PERMITTING AUTHORITY DURING THE CONSTRUCTION. THE CONTRACTOR SHALL BE RESPONSIBLE FOR CARRYING OUT THE S.W.P.P.P. AND INSPECTING AND MAINTAINING ALL BMP'S CALLED FOR BY THE PLAN. THE CONTRACTOR SHALL SUBMIT A NOTICE OF TERMINATION (N.O.T.) FORM TO THE REGIONAL EPA OFFICE WITHIN 30 DAYS OF FINAL STABILIZATION OF THE ENTIRE SITE OR TURNING OVER CONTROL OF THE SITE TO ANOTHER OPERATOR.
- INSTALL PERIMETER CONTROLS, I.E., SILT/SOXX AROUND THE LIMITS OF DISTURBANCE AND CATCH BASIN BASKETS AS NEEDED BEFORE ANY EARTH MOVING OPERATIONS.
- CONSTRUCT STABILIZED CONSTRUCTION ENTRANCE.
- CUT AND GRUB ALL TREES, SHRUBS, SAPLINGS, BRUSH, VINES AND REMOVE OTHER DEBRIS AND RUBBISH AS REQUIRED.
- DEMOLISH EXISTING WALKWAYS, PAVEMENT, AND UTILITIES AS INDICATED ON THE PLANS.
- REPLANT TREES OR MOVE TO STABLE LOCATION.
- BEGIN CONSTRUCTION OF ADDITIONS.
- LAYOUT AND INSTALL ALL BURIED UTILITIES AND SERVICES UP TO 10' OF THE PROPOSED BUILDING FOUNDATIONS. CAP AND MARK TERMINATIONS OR LOG SWING TIES.
- FINISH GRADE SITE, BACKFILL ROAD SUBBASE GRAVEL IN TWO, COMPACTED LIFTS. PROVIDE TEMPORARY EROSION PROTECTION IN THE FORM OF MULCHING, JUTE MESH OR DITCH DAMS.
- INSTALL RETAINING WALL.
- INSTALL DRAINAGE SYSTEM.
- PLACE BINDER LAYER OF PAVEMENT, THEN RAISE CATCH BASIN FRAMES TO FINAL GRADE. REINSTALL BASIN INLET PROTECTION.
- PLANT LANDSCAPING IN AREAS OUT OF WAY OF BUILDING CONSTRUCTION. PREPARE AND STABILIZE FINAL SITE GRADING BY ADDING TOPSOIL, SEED, MULCH AND FERTILIZER.
- AFTER BUILDINGS ARE COMPLETED, FINISH ALL REMAINING LANDSCAPED WORK.
- CONSTRUCT ASPHALT WEARING COURSE.
- REMOVE TRAPPED SEDIMENTS FROM COLLECTION DEVICES AS APPROPRIATE, AND THEN REMOVE TEMPORARY EROSION CONTROL MEASURES UPON COMPLETION OF FINAL STABILIZATION OF THE SITE.

GENERAL CONSTRUCTION NOTES

- THE EROSION CONTROL PROCEDURES SHALL CONFORM TO SECTION 645 OF THE "STANDARD SPECIFICATION FOR ROAD AND BRIDGE CONSTRUCTION" OF THE NHDOT, AND "STORM WATER MANAGEMENT AND EROSION AND SEDIMENT CONTROL HANDBOOK FOR URBAN AND DEVELOPING AREAS IN NEW HAMPSHIRE". THE PROJECT IS TO BE MANAGED IN A MANNER THAT MEETS THE REQUIREMENTS AND INTENT OF RSA 430:53 AND CHAPTER AGR 3800 RELATIVE TO INVASIVE SPECIES.
- DURING CONSTRUCTION AND THEREAFTER, EROSION CONTROL MEASURES ARE TO BE IMPLEMENTED AS NOTED. THE SMALLEST PRACTICAL AREA OF LAND SHOULD BE EXPOSED AT ANY ONE TIME DURING DEVELOPMENT. NO DISTURBED AREA SHALL BE LEFT UNSTABILIZED FOR MORE THAN 45 DAYS.
- ANY DISTURBED AREAS WHICH ARE TO BE LEFT TEMPORARILY, AND WHICH WILL BE REGRADED LATER DURING CONSTRUCTION SHALL BE MACHINE HAY MULCHED AND SEEDED WITH RYE GRASS TO PREVENT EROSION.
- DUST CONTROL: IF TEMPORARY STABILIZATION PRACTICES, SUCH AS TEMPORARY VEGETATION AND MULCHING, DO NOT ADEQUATELY REDUCE DUST GENERATION, APPLICATION OF WATER OR CALCIUM CHLORIDE SHALL BE APPLIED IN ACCORDANCE WITH BEST MANAGEMENT PRACTICES.
- SILT FENCES AND SILT/SOXX SHALL BE PERIODICALLY INSPECTED DURING THE LIFE OF THE PROJECT AND AFTER EACH STORM. ALL DAMAGED SILT FENCES AND SILT/SOXX SHALL BE REPAIRED. SEDIMENT DEPOSITS SHALL PERIODICALLY BE REMOVED AND DISPOSED IN A SECURED LOCATION.
- AVOID THE USE OF FUTURE OPEN SPACES (LOAM AND SEED AREAS) WHEREVER POSSIBLE DURING CONSTRUCTION. CONSTRUCTION TRAFFIC SHALL USE THE ROADBEDS OF FUTURE ACCESS DRIVES AND PARKING AREAS.
- ADDITIONAL TOPSOIL REQUIRED FOR THE ESTABLISHMENT OF VEGETATION SHALL BE STOCKPILED IN AMOUNTS NECESSARY TO COMPLETE FINISHED GRADING OF ALL EXPOSED AREAS--CONSTRUCT SILT FENCE OR SILT/SOXX AROUND TOPSOIL STOCKPILE.
- AREAS TO BE FILLED SHALL BE CLEARED, GRUBBED AND STRIPPED OF TOPSOIL TO REMOVE TREES, VEGETATION, ROOTS OR OTHER OBJECTIONABLE MATERIAL. STUMPS SHALL BE DISPOSED OF IN AN APPROVED FACILITY.
- ALL FILLS SHALL BE PLACED AND COMPACTED TO REDUCE EROSION, SLIPPAGE, SETTLEMENT, SUBSIDENCE OR OTHER RELATED PROBLEMS.
- ALL NON-STRUCTURAL, SITE-FILL SHALL BE PLACED AND COMPACTED TO 90% MODIFIED PROCTOR DENSITY IN LAYERS NOT EXCEEDING 18 INCHES IN THICKNESS UNLESS OTHERWISE NOTED.
- FROZEN MATERIAL OR SOFT, MUCKY OR HIGHLY COMPRESSIBLE MATERIAL, TRASH, WOODY DEBRIS, LEAVES, BRUSH OR ANY DELETERIOUS MATTER SHALL NOT BE INCORPORATED INTO FILLS.
- FILL MATERIAL SHALL NOT BE PLACED ON FROZEN FOUNDATION SUBGRADE.
- DURING CONSTRUCTION AND UNTIL ALL DEVELOPED AREAS ARE FULLY STABILIZED, ALL EROSION CONTROL MEASURES SHALL BE INSPECTED WEEKLY AND AFTER EACH ONE HALF INCH OF RAINFALL.
- THE CONTRACTOR SHALL MODIFY OR ADD EROSION CONTROL MEASURES AS NECESSARY TO ACCOMMODATE PROJECT CONSTRUCTION.
- ALL ROADWAYS AND PARKING AREAS SHALL BE STABILIZED WITHIN 72 HOURS OF ACHIEVING FINISHED GRADE. ALL CUT AND FILL SLOPES SHALL BE SEEDED/LOAMED WITHIN 72 HOURS OF ACHIEVING FINISHED GRADE.
- AN AREA SHALL BE CONSIDERED STABLE IF ONE OF THE FOLLOWING HAS OCCURRED:
 - BASE COURSE GRAVELS HAVE BEEN INSTALLED ON AREAS TO BE PAVED
 - A MINIMUM OF 85% VEGETATED GROWTH HAS BEEN ESTABLISHED
 - A MINIMUM OF 3 INCHES OF NON-EROSIVE MATERIAL SUCH AS STONE OR RIPRAP HAS BEEN INSTALLED
 - EROSION CONTROL BLANKETS HAVE BEEN INSTALLED

VEGETATIVE PRACTICE

FOR PERMANENT MEASURES AND PLANTINGS:

- LIMESTONE SHALL BE THOROUGHLY INCORPORATED INTO THE LOAM LAYER AT A RATE OF 2 TONS PER ACRE.
- FERTILIZER SHALL BE SPREAD ON THE TOP LAYER OF LOAM AND WORKED INTO THE SURFACE. FERTILIZER APPLICATION RATE SHALL BE 500 POUNDS PER ACRE OF 10-20-20 FERTILIZER.
- SEED SHALL BE SOWN AT THE RATES SHOWN IN THE TABLE BELOW. IMMEDIATELY BEFORE SEEDING,

THE SOIL SHALL BE LIGHTLY RAKED, ONE HALF THE SEED SHALL BE SOWN IN ONE DIRECTION AND THE OTHER HALF AT RIGHT ANGLES TO THE ORIGINAL DIRECTION. IT SHALL BE LIGHTLY RAKED INTO THE SOIL TO A DEPTH NOT OVER 1/4 INCH AND ROLLED WITH A HAND ROLLER WEIGHING NOT OVER 100 POUNDS PER LINEAR FOOT OF WIDTH. HAY MULCH SHALL BE APPLIED IMMEDIATELY AFTER SEEDING AT A RATE OF 1.5 TO 2 TONS PER ACRE, AND SHALL BE HELD IN PLACE USING APPROPRIATE TECHNIQUES FROM THE EROSION AND SEDIMENT CONTROL HANDBOOK.

THE SURFACE SHALL BE WATERED AND KEPT MOIST WITH A FINE SPRAY AS REQUIRED, WITHOUT WASHING AWAY THE SOIL, UNTIL THE GRASS IS WELL ESTABLISHED. ANY AREAS WHICH ARE NOT SATISFACTORILY COVERED SHALL BE RESEED, AND ALL NOXIOUS WEEDS REMOVED.

A GRASS SEED MIXTURE CONTAINING THE FOLLOWING SEED REQUIREMENTS SHALL BE:

GENERAL COVER	PROPORTION	SEEDING RATE
CREeping RED FESCUE	50%	100 LBS/ACRE
KENTUCKY BLUEGRASS	50%	
SLOPE SEED (USED ON ALL SLOPES GREATER THAN OR EQUAL TO 3:1)		
CREeping RED FESCUE	42%	
TALL FESCUE	42%	48 LBS/ACRE
BIRDSFOOT TREFLOIL	16%	

IN NO CASE SHALL THE WEED CONTENT EXCEED ONE PERCENT BY WEIGHT. ALL SEED SHALL COMPLY WITH APPLICABLE STATE AND FEDERAL SEED LAWS.

FOR TEMPORARY PROTECTION OF DISTURBED AREAS:
 MULCHING AND SEEDING SHALL BE APPLIED AT THE FOLLOWING RATES:
 PERENNIAL RYE: 0.7 LBS/1,000 S.F.
 MULCH: 1.5 TONS/ACRE

MAINTENANCE AND PROTECTION

- THE CONTRACTOR SHALL MAINTAIN ALL LOAM & SEED AREAS UNTIL FINAL ACCEPTANCE AT THE COMPLETION OF THE CONTRACT. MAINTENANCE SHALL INCLUDE WATERING, WEEDING, REMOVAL OF STONES AND OTHER FOREIGN OBJECTS OVER 1/2 INCHES IN DIAMETER WHICH MAY APPEAR AND THE FIRST TWO (2) CUTTINGS OF GRASS NO CLOSER THEN TEN (10) DAYS APART. THE FIRST CUTTING SHALL BE ACCOMPLISHED WHEN THE GRASS IS FROM 2 1/2 TO 3 INCHES HIGH. ALL BARE AND DEAD SPOTS WHICH BECOME APPARENT SHALL BE PROPERLY PREPARED, LIMED AND FERTILIZED, AND RESEEDED BY THE CONTRACTOR AT HIS EXPENSE AS MANY TIMES AS NECESSARY TO SECURE GOOD GROWTH. THE ENTIRE AREA SHALL BE MAINTAINED, WATERED AND CUT UNTIL ACCEPTANCE OF THE LAWN BY THE OWNER'S REPRESENTATIVE.
- THE CONTRACTOR SHALL TAKE WHATEVER MEASURES ARE NECESSARY TO PROTECT THE GRASS WHILE IT IS DEVELOPING.
- TO BE ACCEPTABLE, SEEDED AREAS SHALL CONSIST OF A UNIFORM STAND OF AT LEAST 90 PERCENT ESTABLISHED PERMANENT GRASS SPECIES, WITH UNIFORM COUNT OF AT LEAST 100 PLANTS PER SQUARE FOOT.
- SEEDED AREAS WILL BE FERTILIZED AND RESEEDED AS NECESSARY TO INSURE VEGETATIVE ESTABLISHMENT.
- THE SWALES WILL BE CHECKED WEEKLY AND REPAIRED WHEN NECESSARY UNTIL ADEQUATE VEGETATION IS ESTABLISHED.
- THE SILT FENCE OR SILT/SOXX BARRIER SHALL BE CHECKED AFTER EACH RAINFALL AND AT LEAST DAILY DURING PROLONGED RAINFALL.
- SILT FENCING AND SILT/SOXX SHALL BE REMOVED ONCE VEGETATION IS ESTABLISHED, AND DISTURBED AREAS RESULTING FROM SILT FENCE AND SILT/SOXX REMOVAL SHALL BE PERMANENTLY SEEDED.

WINTER NOTES

- ALL PROPOSED VEGETATED AREAS WHICH DO NOT EXHIBIT A MINIMUM OF 85% VEGETATIVE GROWTH BY OCTOBER 15TH, OR WHICH ARE DISTURBED AFTER OCTOBER 15TH, SHALL BE STABILIZED BY SEEDING AND INSTALLING EROSION CONTROL BLANKETS ON SLOPES GREATER THAN 3:1, AND SEEDING AND PLACING 3 TO 4 TONS OF MULCH PER ACRE, SECURED WITH ANCHORED NETTING, ELSEWHERE. THE INSTALLATION OF EROSION CONTROL BLANKETS OR MULCH AND NETTING SHALL NOT OCCUR OVER ACCUMULATED SNOW OR ON FROZEN GROUND AND SHALL BE COMPLETED IN ADVANCE OF THAW OR SPRING MELT EVENTS.
- ALL DITCHES OR SWALES WHICH DO NOT EXHIBIT A MINIMUM OF 85% VEGETATIVE GROWTH BY OCTOBER 15TH, OR WHICH ARE DISTURBED AFTER OCTOBER 15TH, SHALL BE STABILIZED TEMPORARILY WITH STONE OR EROSION CONTROL BLANKETS APPROPRIATE FOR THE DESIGN FLOW CONDITIONS.
- AFTER NOVEMBER 15TH, INCOMPLETE ROAD OR PARKING SURFACES, WHERE WORK HAS STOPPED FOR THE WINTER SEASON, SHALL BE PROTECTED WITH A MINIMUM OF 3 INCHES OF CRUSHED GRAVEL PER NHDOT ITEM 304.3.

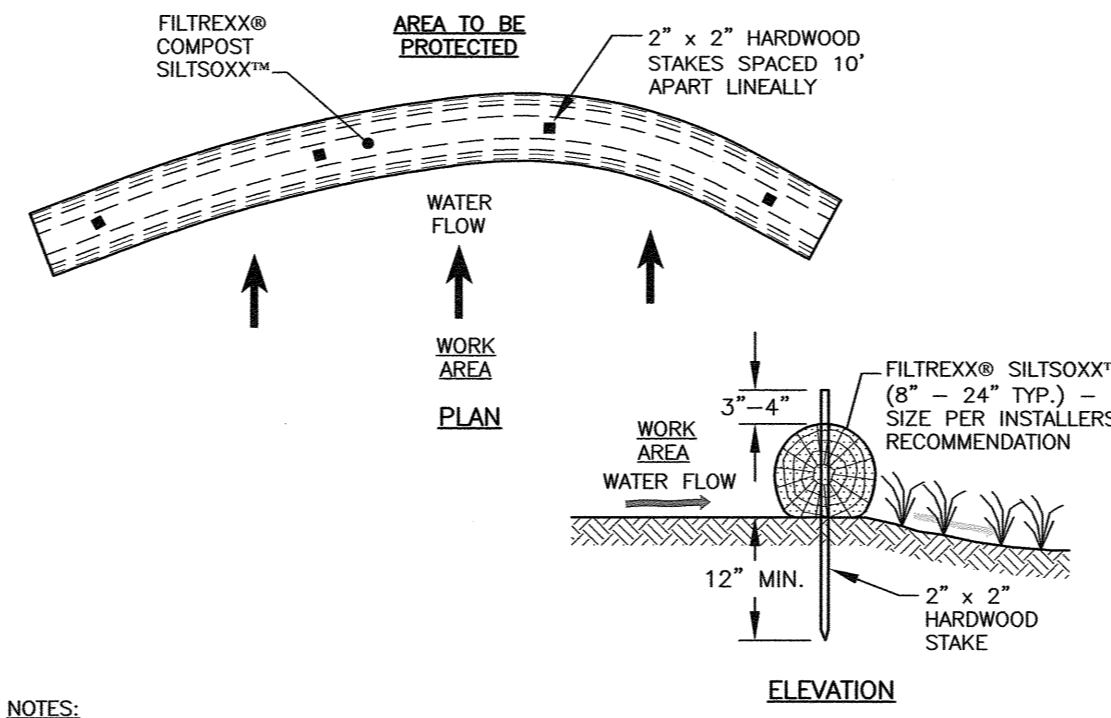

- NOTES:**
- ALL MATERIAL TO MEET FILTRIXX SPECIFICATIONS.
 - FILTRIXX SYSTEM SHALL BE INSTALLED BY A CERTIFIED FILTRIXX INSTALLER.
 - THE CONTRACTOR SHALL MAINTAIN THE COMPOST FILTRATION SYSTEM IN A FUNCTIONAL CONDITION AT ALL TIMES. IT WILL BE ROUTINELY INSPECTED AND REPAIRED WHEN REQUIRED.
 - SILT/SOXX DEPICTED IS FOR MINIMUM SLOPES, GREATER SLOPES MAY REQUIRE ADDITIONAL PLACEMENTS.
 - THE COMPOST FILTER MATERIAL WILL BE DISPENSED ON SITE WHEN NO LONGER REQUIRED, AS DETERMINED BY THE ENGINEER.

A C6 FILTRIXX® SILT/SOXX™ FILTRATION SYSTEM NTS

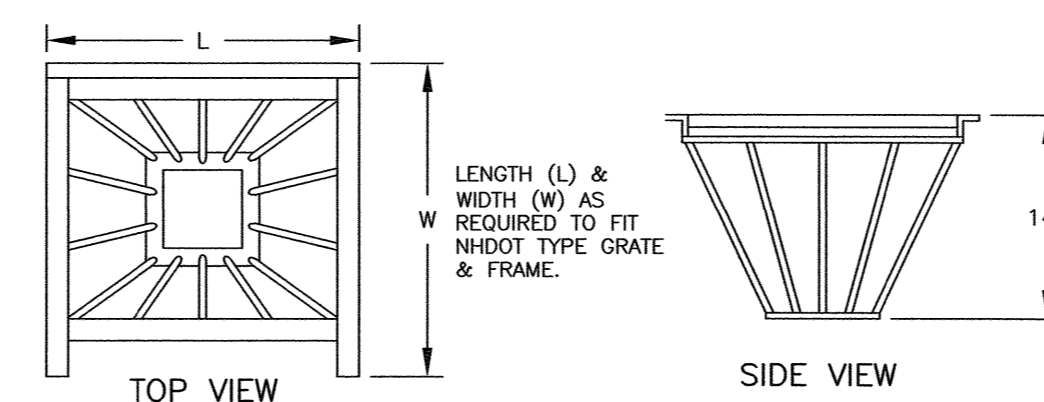

- INLET BASKETS SHALL BE INSTALLED IMMEDIATELY AFTER CATCH BASIN CONSTRUCTION IS COMPLETE AND SHALL REMAIN IN PLACE AND BE MAINTAINED UNTIL PAVEMENT BINDER COURSE IS COMPLETE.
- FILTER FABRIC SHALL BE PUSHED DOWN AND FORMED TO THE SHAPE OF THE BASKET. THE SHEET OF FABRIC SHALL BE LARGE ENOUGH TO BE SUPPORTED BY THE BASKET FRAME WHEN HOLDING SEDIMENT AND, SHALL EXTEND AT LEAST 6" PAST THE FRAME. THE INLET GRATE SHALL BE PLACED OVER THE BASKET/FRAME AND WILL SERVE AS THE FABRIC ANCHOR.
- THE FILTER FABRIC SHALL BE A GEOTEXTILE FABRIC: POLYESTER, POLYPROPYLENE, STABILIZED NYLON, POLYETHYLENE, OR POLYVINYLIDENE CHLORIDE MEETING THE FOLLOWING SPECIFICATIONS:
 - RAB STRENGTH: 45 LB. MIN. IN ANY PRINCIPAL DIRECTION (ASTM D1682)
 - MULLEN BURST STRENGTH: MIN. 60 psi (ASTM D774)
- THE FABRIC SHALL HAVE AN OPENING NO GREATER THAN A NUMBER 20 U.S. STANDARD SIEVE AND A MINIMUM PERMEABILITY OF 120 gpm/ft. (MULTIPLY THE PERMITTIVITY IN SEC.-1 FROM ASTM 54491-85 CONSTANT HEAD TEST USING THE CONVERSION FACTOR OF 74.)
- THE INLET BASKET SHALL BE INSPECTED WITHIN 24 HOURS AFTER EACH RAINFALL OR DAILY DURING EXTENDED PERIODS OF PRECIPITATION. REPAIRS SHALL BE MADE IMMEDIATELY, AS NECESSARY, TO PREVENT PARTICLES FROM REACHING THE DRAINAGE SYSTEM AND/OR CAUSING SURFACE FLOODING.
- SEDIMENT DEPOSITS SHALL BE REMOVED AFTER EACH STORM EVENT, OR MORE OFTEN IF THE FABRIC BECOMES CLOGGED.

B C6 CATCH BASIN INLET BASKET NTS

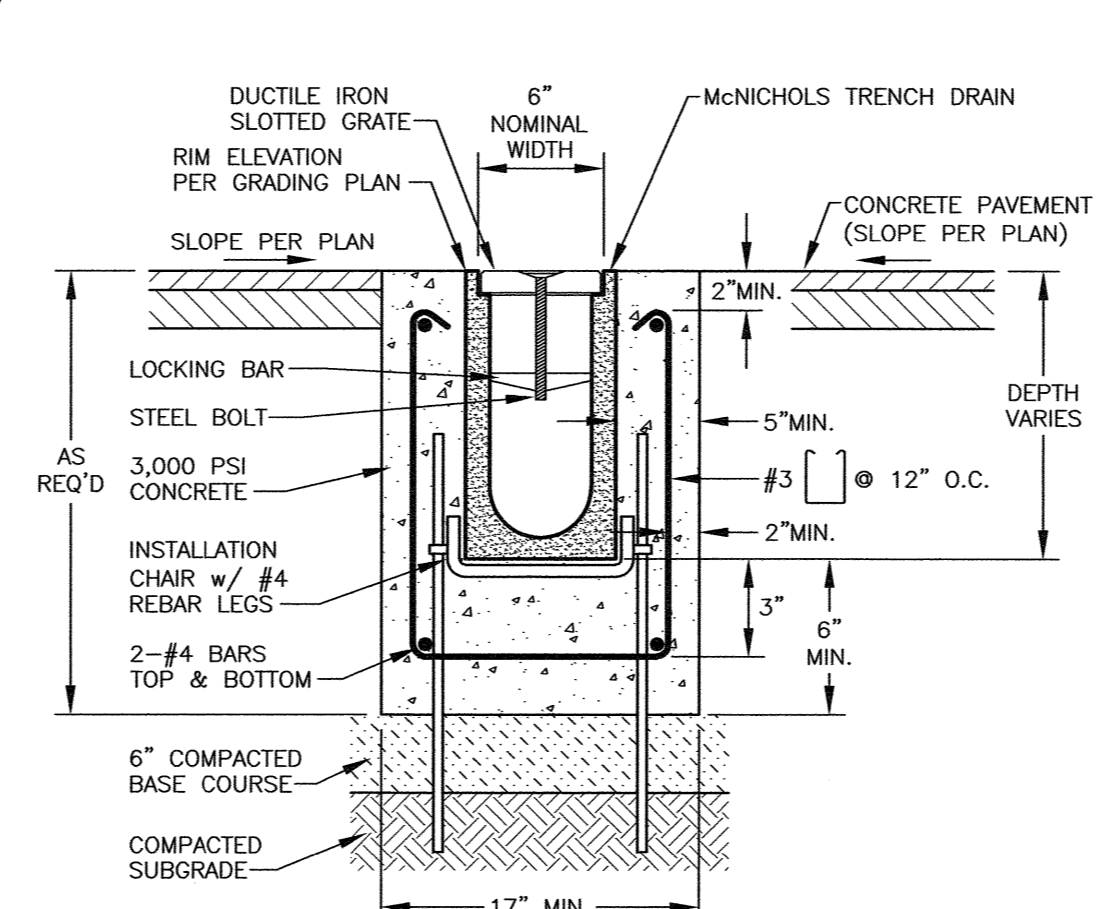

D C4 EVAPORATIVE TRENCH DRAIN DETAIL NTS SECTION

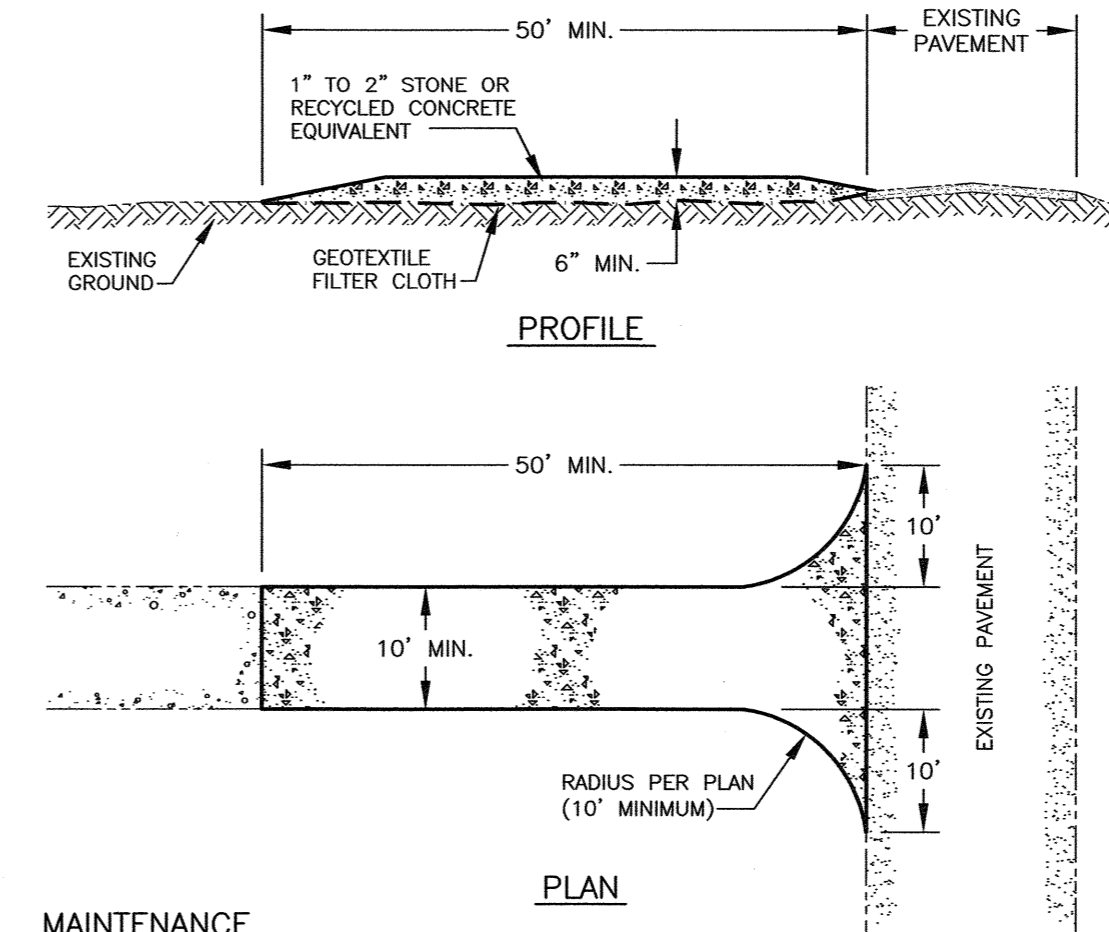

- MAINTENANCE**
- MUD AND SOIL PARTICLES WILL EVENTUALLY CLOG THE VOIDS IN THE GRAVEL AND THE EFFECTIVENESS OF THE GRAVEL PAD WILL NOT BE SATISFACTORY. WHEN THIS OCCURS, THE PAD SHOULD BE TOP DRESSED WITH NEW STONE. COMPLETE REPLACEMENT OF THE PAD MAY BE NECESSARY WHEN THE PAD BECOMES COMPLETELY CLOGGED.
 - IF WASHING FACILITIES ARE USED, THE SEDIMENT TRAPS SHOULD BE CLEANED OUT AS OFTEN AS NECESSARY TO ASSURE THAT ADEQUATE TRAPPING EFFICIENCY AND STORAGE VOLUME IS AVAILABLE. VEGETATIVE FILTER STRIPS SHOULD BE MAINTAINED TO INSURE A VIGOROUS STAND OF VEGETATION AT ALL TIMES.

CONSTRUCTION SPECIFICATIONS

- STONE FOR A STABILIZED CONSTRUCTION ENTRANCE SHALL BE 1 TO 2 INCH STONE, RECLAIMED STONE, OR RECYCLED CONCRETE EQUIVALENT.
- THE LENGTH OF THE STABILIZED ENTRANCE SHALL NOT BE LESS THAN 50 FEET, EXCEPT FOR A SINGLE RESIDENTIAL LOT WHERE A 30 FOOT MINIMUM LENGTH WOULD APPLY.
- THE THICKNESS OF THE STONE FOR THE STABILIZED ENTRANCE SHALL NOT BE LESS THAN 6 INCHES.
- THE WIDTH OF THE ENTRANCE SHALL NOT BE LESS THAN THE FULL WIDTH OF THE ENTRANCE WHERE INGRESS OR EGRESS OCCURS OR 10 FEET, WHICHEVER IS GREATER.
- GEOTEXTILE FILTER CLOTH SHALL BE PLACED OVER THE ENTIRE AREA PRIOR TO PLACING THE STONE. FILTER CLOTH IS NOT REQUIRED FOR A SINGLE FAMILY RESIDENCE LOT.
- ALL SURFACE WATER THAT IS FLOWING TO OR DIVERTED TOWARD THE CONSTRUCTION ENTRANCE SHALL BE PIPED BENEATH THE ENTRANCE. IF PIPING IS IMPRACTICAL, A BERM WITH 5:1 SLOPES THAT CAN BE GROSSED BY VEHICLES MAY BE SUBSTITUTED FOR THE PIPE.
- THE ENTRANCE SHALL BE MAINTAINED IN A CONDITION THAT WILL PREVENT TRACKING OR FLOWING OF SEDIMENT ONTO PUBLIC RIGHTS-OF-WAY. THIS MAY REQUIRE PERIODIC TOP DRESSING WITH ADDITIONAL STONE AS CONDITIONS DEMAND AND REPAIR AND/OR CLEANOUT OF ANY MEASURES USED TO TRAP SEDIMENT. ALL SEDIMENT SPILLED, WASHED, OR TRACKED ONTO PUBLIC RIGHT-OF-WAY MUST BE REMOVED PROMPTLY.
- WHEELS SHALL BE CLEANED TO REMOVE MUD PRIOR TO ENTRANCE ONTO PUBLIC RIGHT-OF-WAY, WHEN WASHING IS REQUIRED, IT SHALL BE DONE ON AN AREA STABILIZED WITH STONE WHICH DRAINS INTO AN APPROVED SEDIMENT TRAPPING DEVICE.

C C6 STABILIZED CONSTRUCTION ENTRANCE NTS

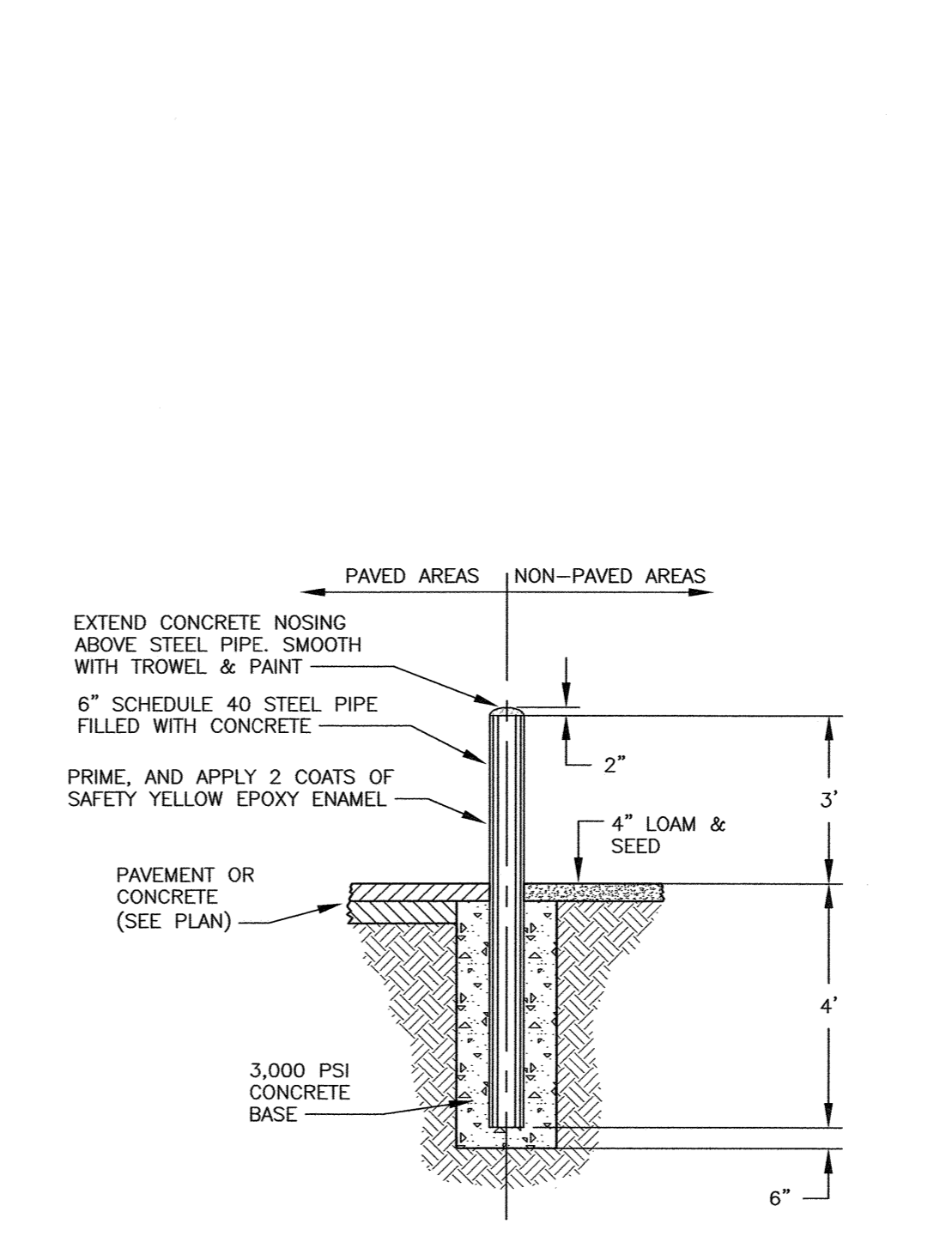

E C3 PIPE BOLLARD DETAIL NTS

APPROVED BY THE PORTSMOUTH PLANNING BOARD

CHAIRMAN _____ DATE _____

AMBIT ENGINEERING, INC.
 A DIVISION OF HALEY WARD, INC.

200 Griffin Road, Unit 3
 Portsmouth, NH 03801
 603.430.9282

WWW.HALEYWARD.COM

MIXED USE DEVELOPMENT
581 LAFAYETTE ROAD
PORTSMOUTH, N.H.

NO.	DESCRIPTION	DATE
0	ISSUED FOR COMMENT	11/20/23

STATE OF NEW HAMPSHIRE
 JOHN R. CHAMON
 No. 7851
 LICENSED PROFESSIONAL ENGINEER

SCALE: AS NOTED NOVEMBER 2023

EROSION CONTROL NOTES & DETAILS **D1**

NOTES:
1) UNDERGROUND UTILITY LOCATIONS ARE BASED UPON BEST AVAILABLE EVIDENCE AND ARE NOT FIELD VERIFIED. LOCATING AND PROTECTING ANY ABOVEGROUND OR UNDERGROUND UTILITIES IS THE SOLE RESPONSIBILITY OF THE CONTRACTOR AND/OR THE OWNER. UTILITY CONFLICTS SHOULD BE REPORTED AT ONCE TO THE DESIGN ENGINEER.

2) THE CONTRACTOR SHALL NOTIFY DIG SAFE AT 1-888-DIG-SAFE (1-888-344-7233) AT LEAST 72 HOURS PRIOR TO COMMENCING ANY EXCAVATION ON PUBLIC OR PRIVATE PROPERTY.

3) CONTRACTOR SHALL INSTALL AND MAINTAIN EROSION CONTROL MEASURES IN ACCORDANCE WITH THE "NEW HAMPSHIRE STORMWATER MANUAL, VOLUME 3, EROSION AND SEDIMENT CONTROLS DURING CONSTRUCTION. (NHDES DECEMBER 2008).

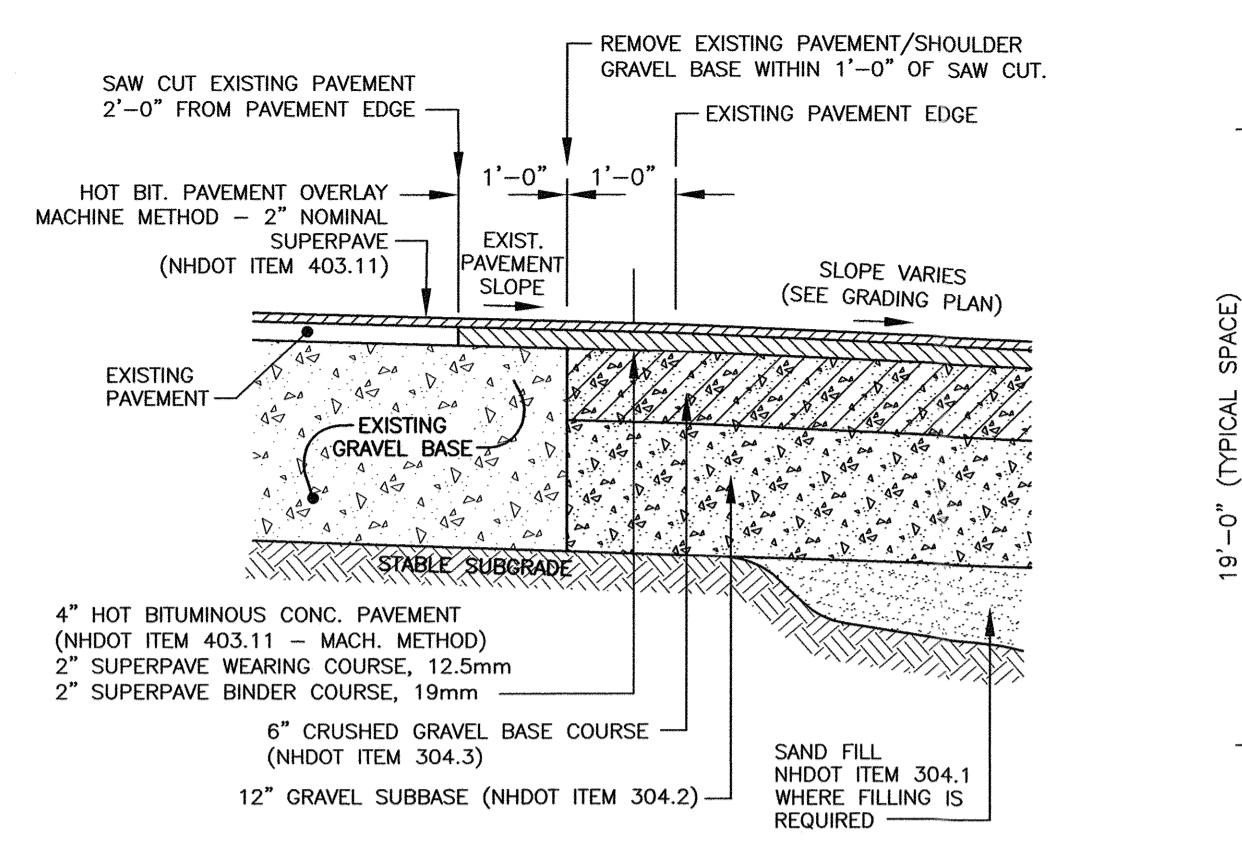

F
C3
FULL DEPTH PAVEMENT SECTION AND PAVEMENT JOINT DETAIL
NTS

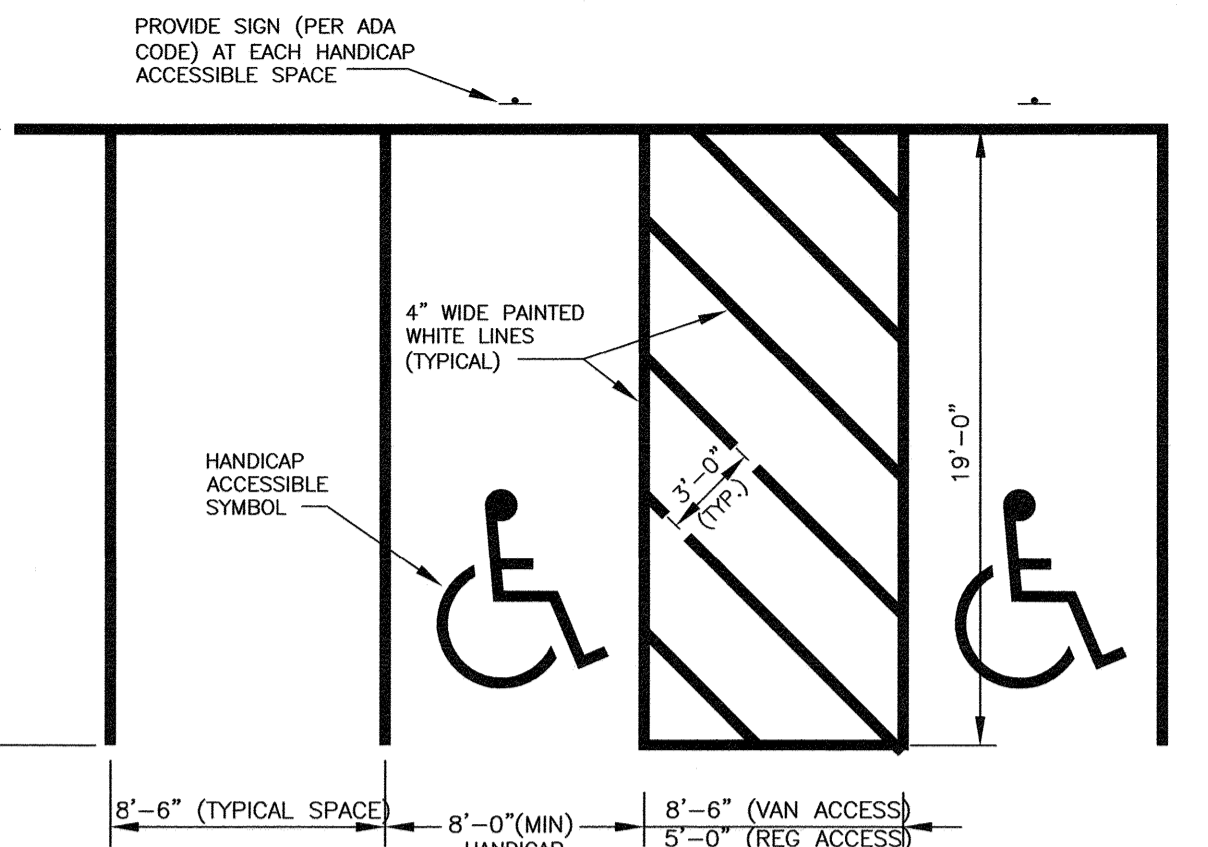

J
C3
PARKING STALL DETAIL
NTS

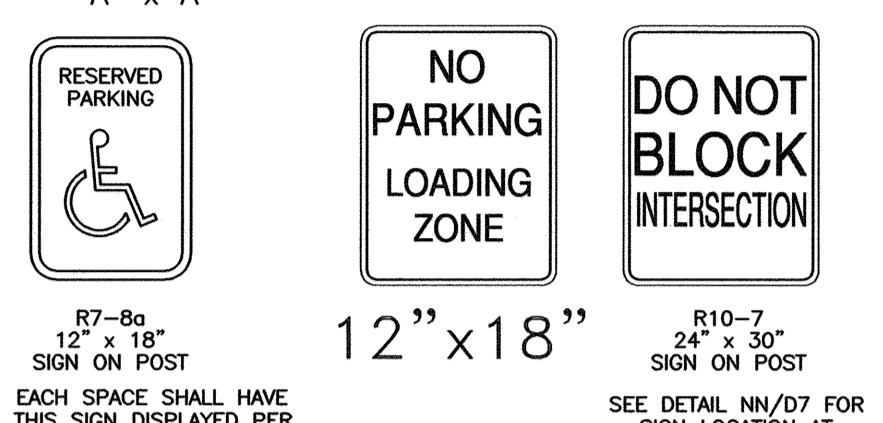
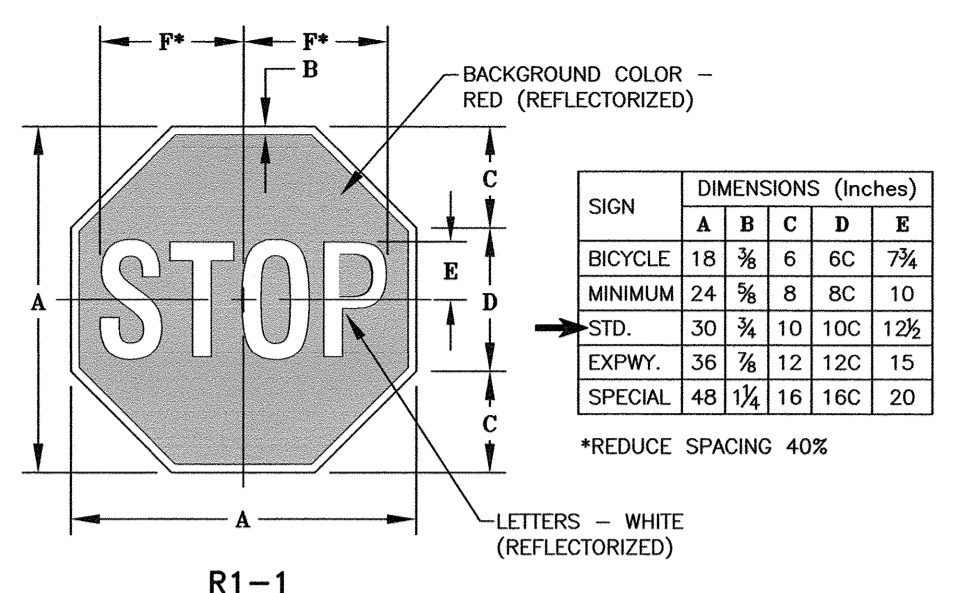

R7-8a
12" x 18"
SIGN ON POST
EACH SPACE SHALL HAVE THIS SIGN DISPLAYED PER ADA CODE

R10-7
24" x 30"
SIGN ON POST
SEE DETAIL NN/D7 FOR SIGN LOCATION AT INTERSECTION OF LEDGWOOD DRIVE AND LAFAYETTE ROAD

R5-1
30" x 30"
SIGN DETAILS
NTS

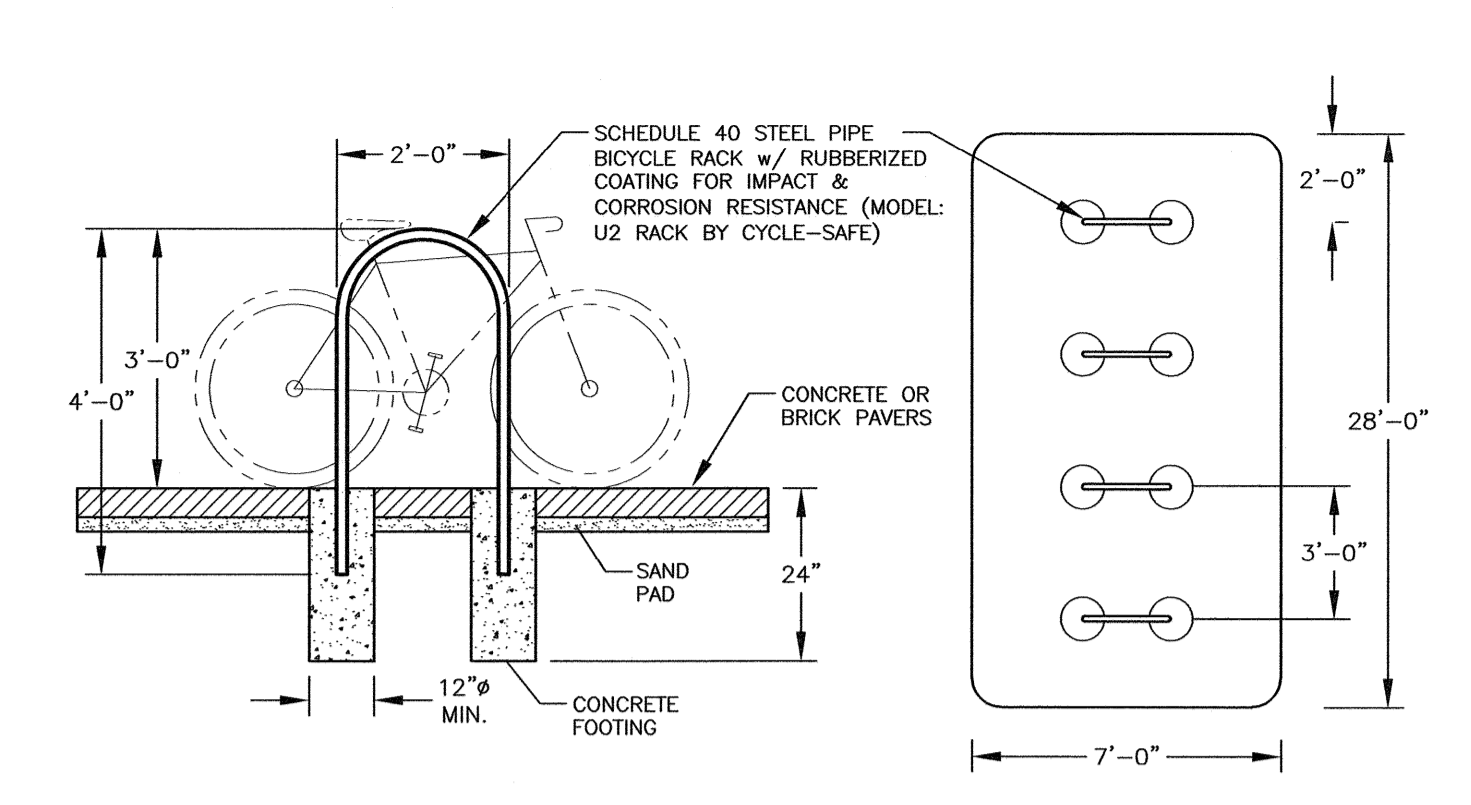

N
C3
UPTURNED "U" BICYCLE RACK
NTS

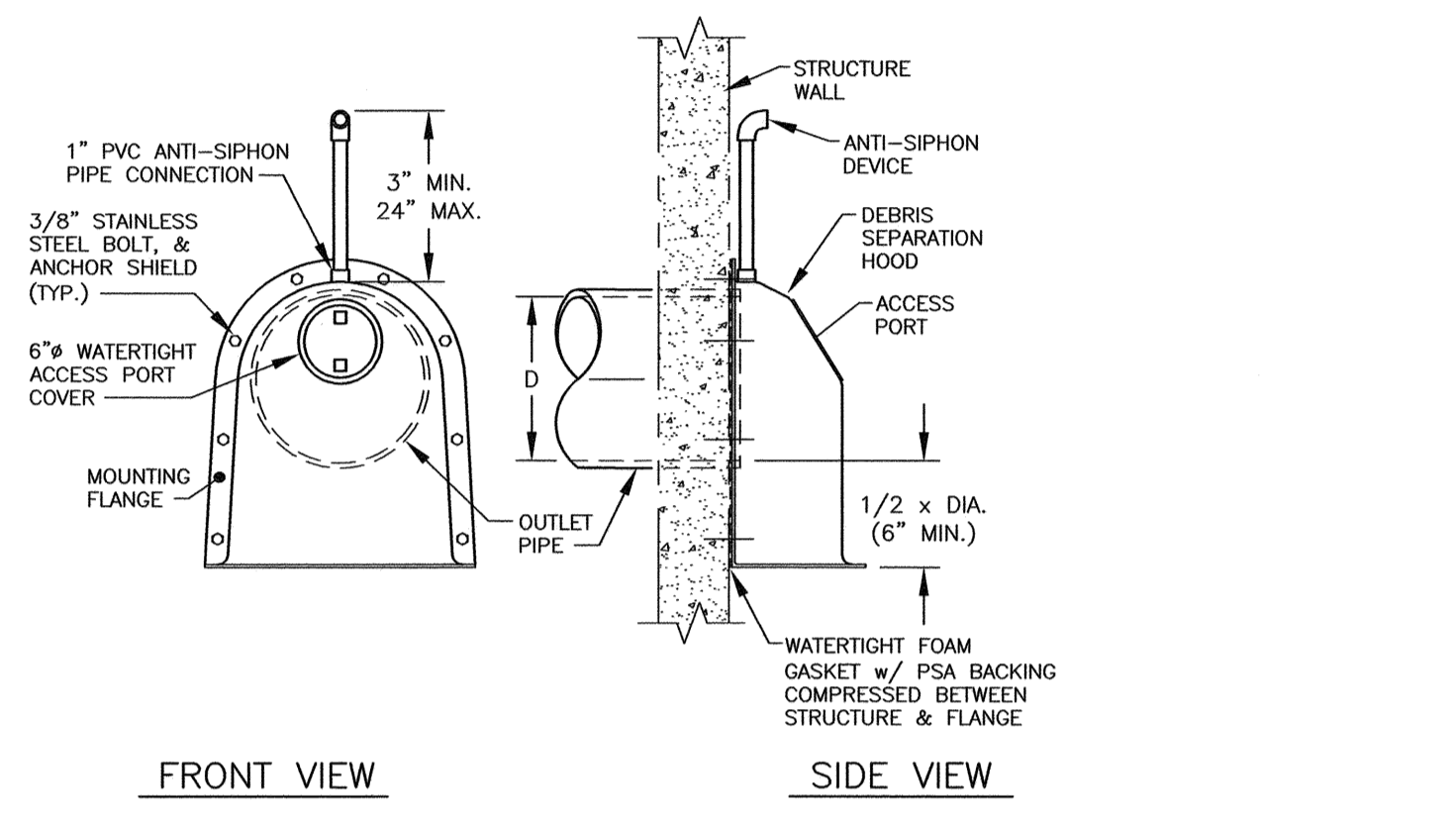

O
C6
CATCH BASIN OUTLET HOOD DETAIL
NTS

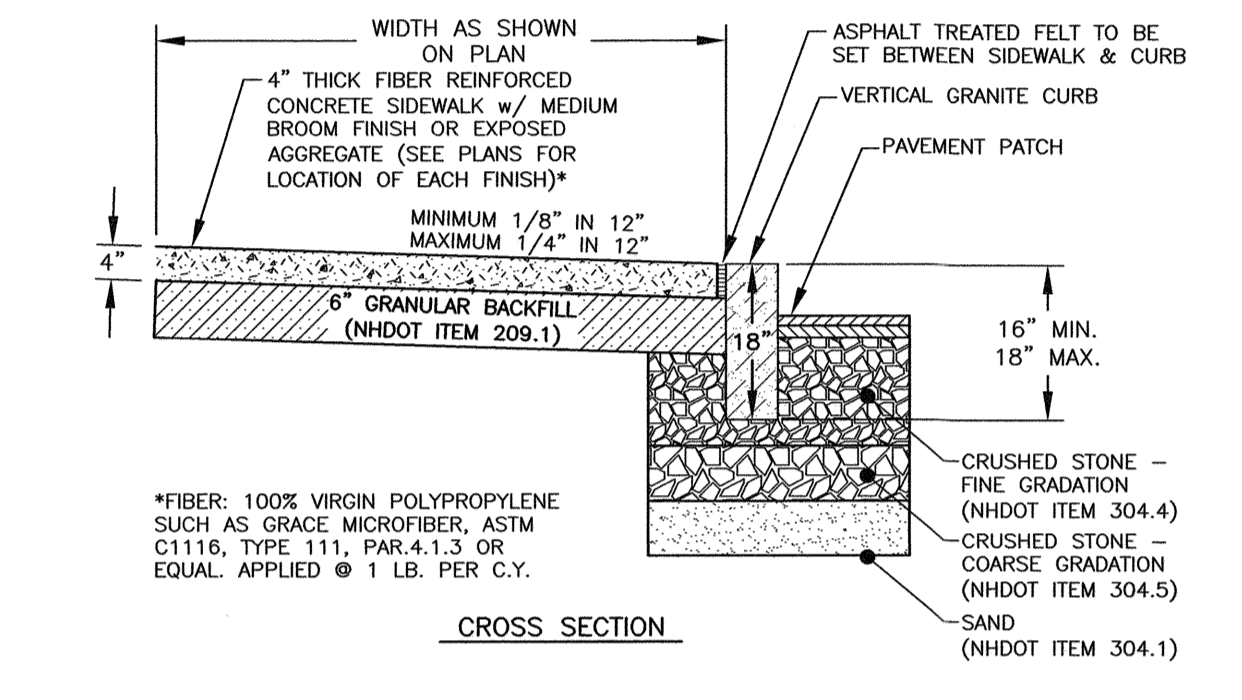

G
C3
PORTLAND CEMENT CONCRETE SIDEWALK
NTS

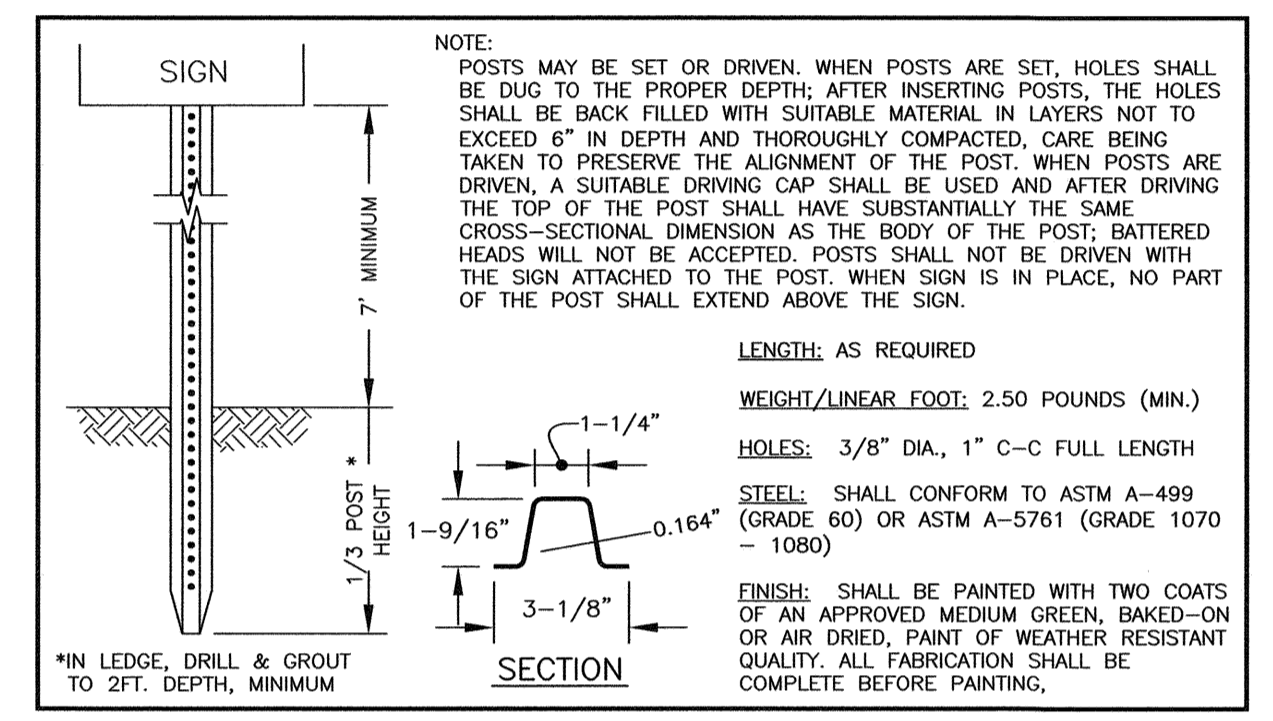

K
C3
SIGN POST DETAIL
NTS

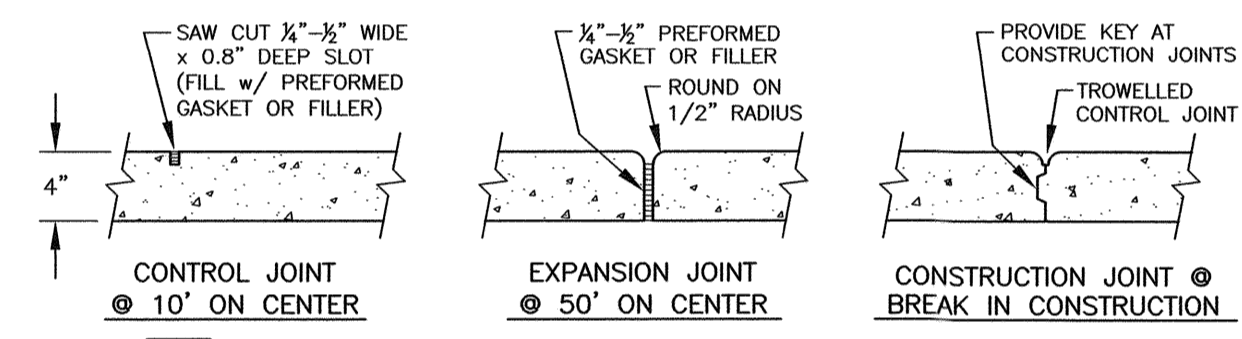

H
C3
GRANITE CURBING DETAILS (CITY OF PORTSMOUTH)
NTS

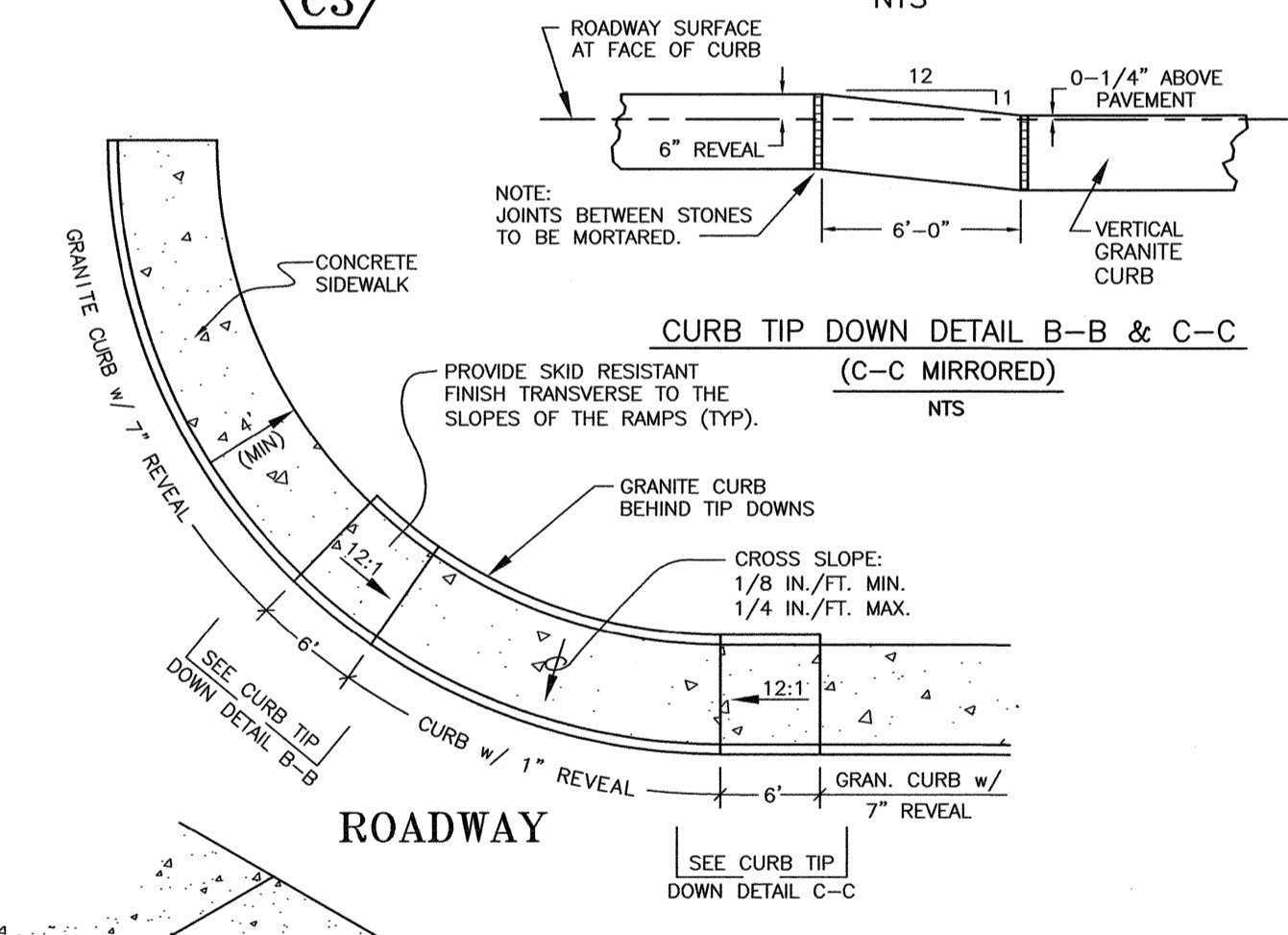

L
C3
TIP DOWNS FOR CONCRETE SIDEWALK
NTS

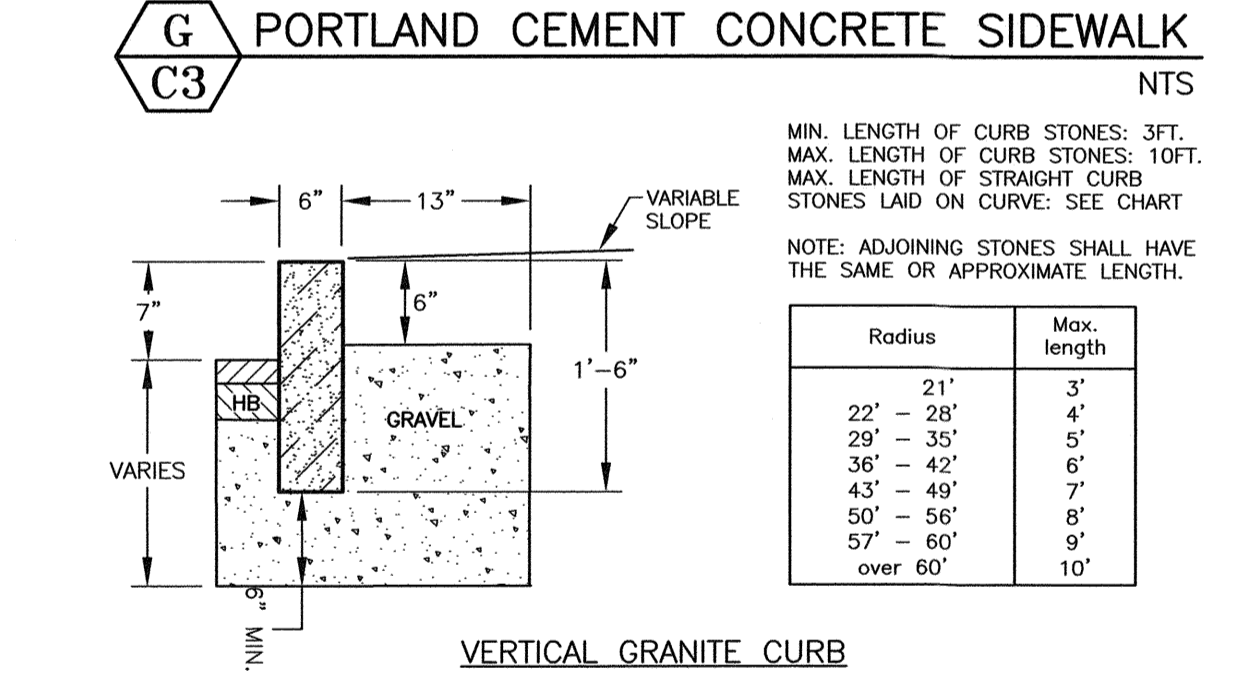

I
C3
PAINTED CROSSWALK DETAIL
NTS

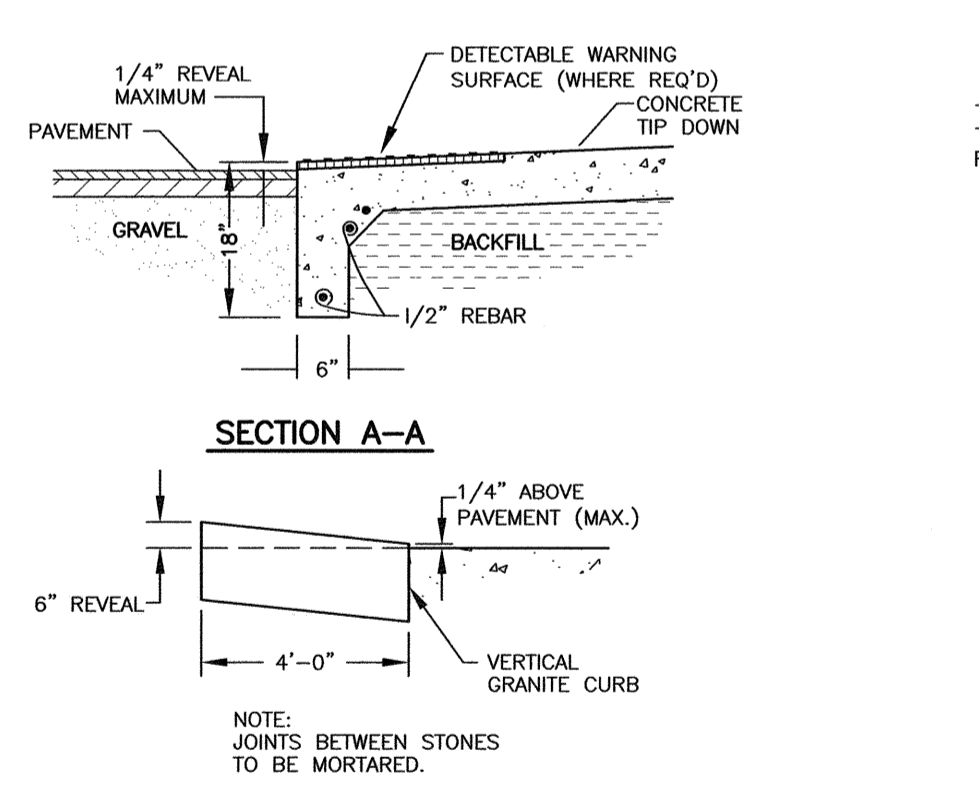

M
C3
GRANITE CURB END FOR VERTICAL GRANITE CURB
NTS

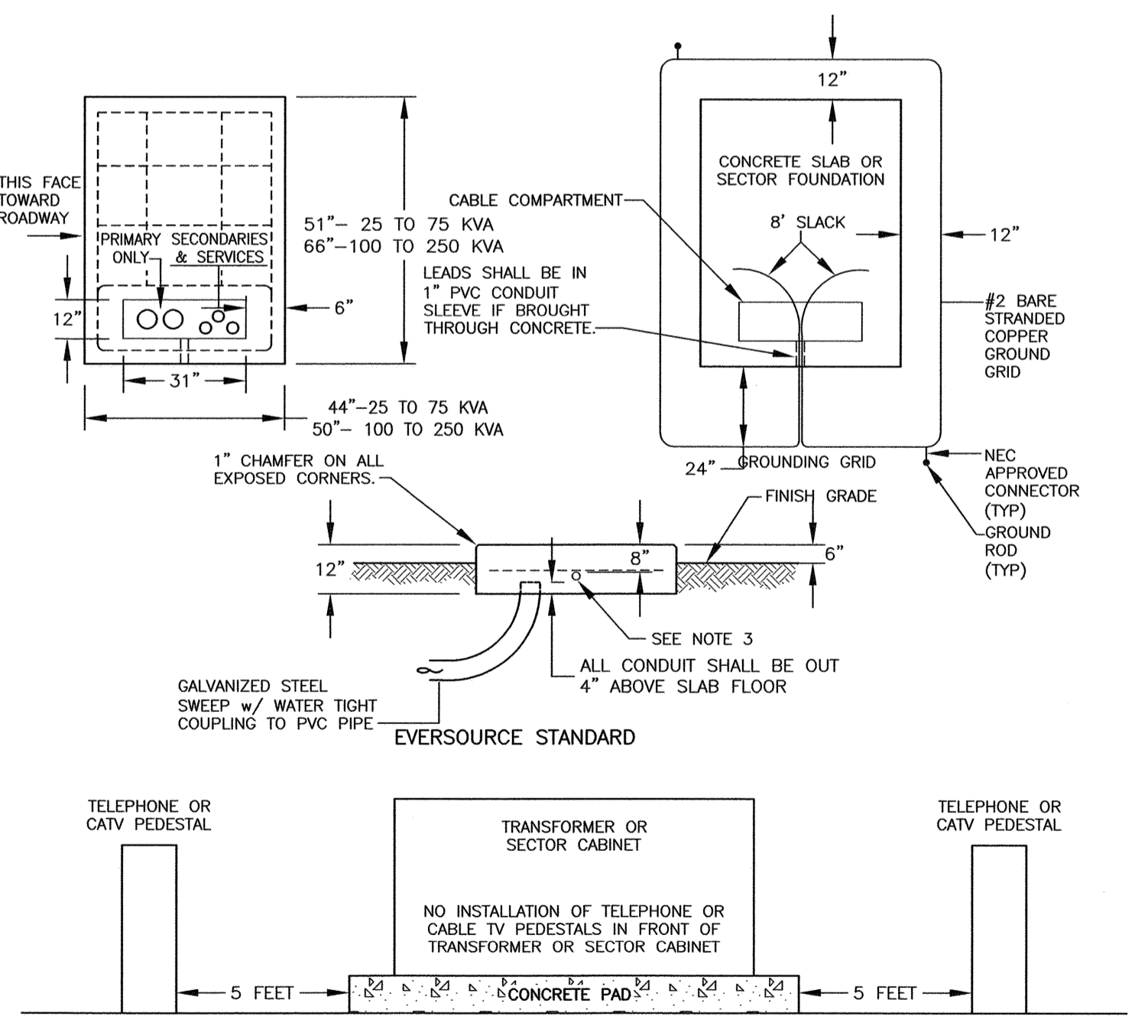

P
C5
TRANSFORMER PAD
COORDINATE WITH EVERSOURCE
NTS

CONSTRUCTION SPECIFICATIONS:
1) SLOPE OF RAMP VARIES WITH SIDEWALK WIDTH & HEIGHT, WITH A MAXIMUM SLOPE OF 12 : 1 AND A MINIMUM SLOPE OF 16 : 1.
2) A SKID RESISTANT FINISH TRANSVERSE TO THE SLOPE OF THE RAMP AND WARPED SIDEWALK, SHALL BE USED ON PORTLAND CEMENT CONCRETE RAMP.

NOTES:
1. ALL REINFORCING TO BE #6 BARS.
2. 1" PVC CONDUIT SLEEVE FOR GROUND LEADS.
3. THE GROUND GRID SHALL BE SUPPLIED AND INSTALLED BY THE CONTRACTOR AND IS TO BE BURIED AT LEAST 12" BELOW GRADE. EIGHT FEET OF EXTRA WIRE FOR EACH GROUND GRID LEG SHALL BE LEFT EXPOSED IN THE CABLE COMPARTMENT TO ALLOW FOR THE CONNECTION TO THE TRANSFORMER. THE TWO 8' GROUND RODS MAY BE EITHER GALVANIZED STEEL OR COPPERWELD AND THEY SHALL BE CONNECTED TO THE GRID WITH NEC APPROVED CONNECTORS.
4. NO SHRUBS, FENCES, OR PERMANENT STRUCTURES CAN BE PLACED WITHIN 10 FEET OF THE FRONT AND 5 FEET OF THE SIDES AND BACK OF PAD-MOUNTED EQUIPMENT. THE COMPANY HAS THE RIGHT TO REMOVE THESE OBJECTS WITHOUT NOTICE TO THE OWNER.

MIXED USE DEVELOPMENT
581 LAFAYETTE ROAD
PORTSMOUTH, N.H.

0	ISSUED FOR COMMENT	11/20/23
NO.	DESCRIPTION	DATE

REVISIONS		
NO.	DESCRIPTION	DATE

SCALE: AS NOTED NOVEMBER 2023

DETAILS **D2**

APPROVED BY THE PORTSMOUTH PLANNING BOARD

CHAIRMAN _____ DATE _____

NOTES:
1) UNDERGROUND UTILITY LOCATIONS ARE BASED UPON BEST AVAILABLE EVIDENCE AND ARE NOT FIELD VERIFIED. LOCATING AND PROTECTING ANY ABOVEGROUND OR UNDERGROUND UTILITIES IS THE SOLE RESPONSIBILITY OF THE CONTRACTOR AND/OR THE OWNER. UTILITY CONFLICTS SHOULD BE REPORTED AT ONCE TO THE DESIGN ENGINEER.

2) THE CONTRACTOR SHALL NOTIFY DIG SAFE AT 1-888-DIG-SAFE (1-888-344-7233) AT LEAST 72 HOURS PRIOR TO COMMENCING ANY EXCAVATION ON PUBLIC OR PRIVATE PROPERTY.

3) CONTRACTOR SHALL INSTALL AND MAINTAIN EROSION CONTROL MEASURES IN ACCORDANCE WITH THE "NEW HAMPSHIRE STORMWATER MANUAL, VOLUME 3, EROSION AND SEDIMENT CONTROLS DURING CONSTRUCTION. (NHDES DECEMBER 2008).

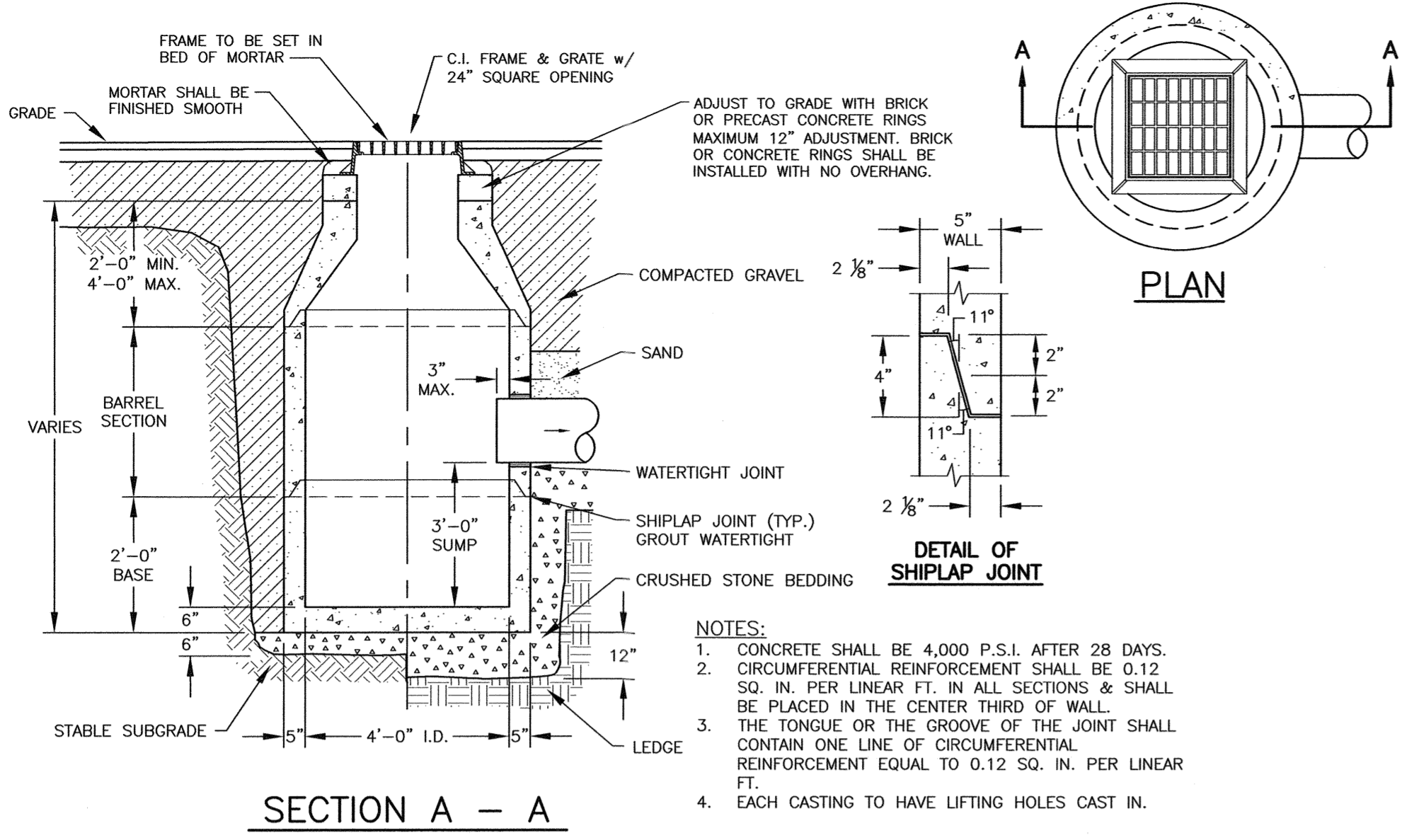

- NOTES:**
1. CONCRETE SHALL BE 4,000 P.S.I. AFTER 28 DAYS.
 2. CIRCUMFERENTIAL REINFORCEMENT SHALL BE 0.12 SQ. IN. PER LINEAR FT. IN ALL SECTIONS & SHALL BE PLACED IN THE CENTER THIRD OF WALL.
 3. THE TONGUE OR THE GROOVE OF THE JOINT SHALL CONTAIN ONE LINE OF CIRCUMFERENTIAL REINFORCEMENT EQUAL TO 0.12 SQ. IN. PER LINEAR FT.
 4. EACH CASTING TO HAVE LIFTING HOLES CAST IN.

Q CATCH BASIN DETAIL
C5 NTS

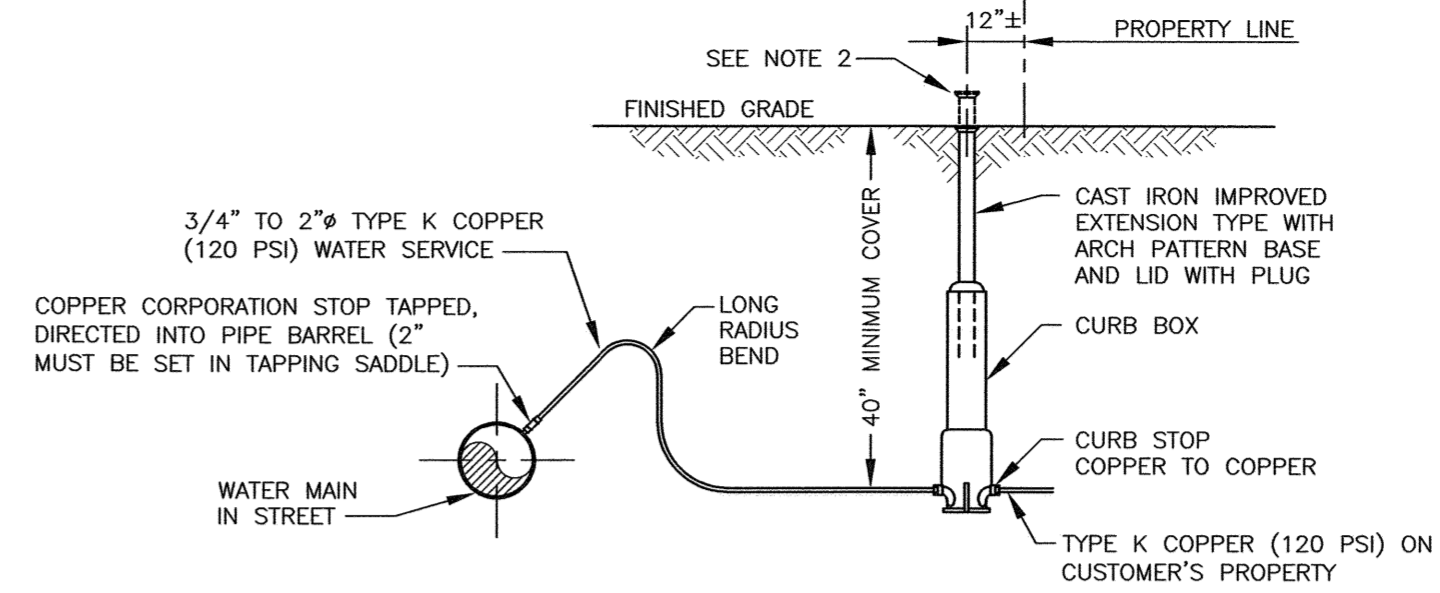
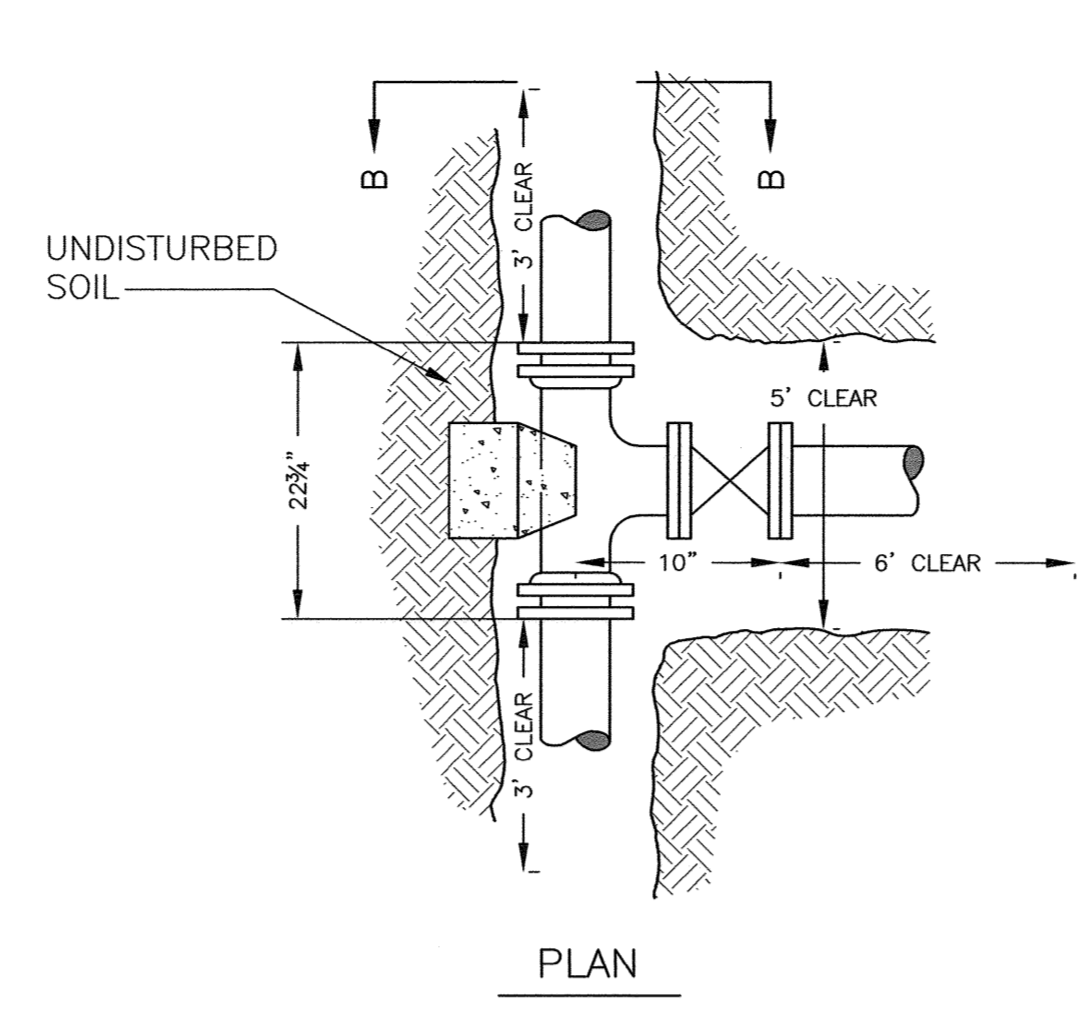

- NOTE:**
- 1) INSTALLATION OF WATER MAIN TAP & CURB STOP & BOX SHALL ONLY BE PERFORMED BY THOSE AUTHORIZED BY THE PUBLIC WORKS DEPARTMENT.
 - 2) IN AREAS OF HEAVY GROWTH THE CURB BOX COVER SHALL BE SET 6" ABOVE FINISH GRADE AND A WITNESS STAKE SET.
 - 3) CURB BOX SHALL BE SET APPROXIMATELY 12" OUTSIDE PROPERTY LINE AS SHOWN.
 - 4) PRIOR TO ACCEPTANCE, A PLAN INDICATING THE LOCATION OF THE CURB BOX SHALL BE SUBMITTED TO THE CITY OF PORTSMOUTH WATER DIVISION.

V WATER SERVICE CONNECTION
C4 INSTALL PER PORTSMOUTH REQUIREMENTS NTS

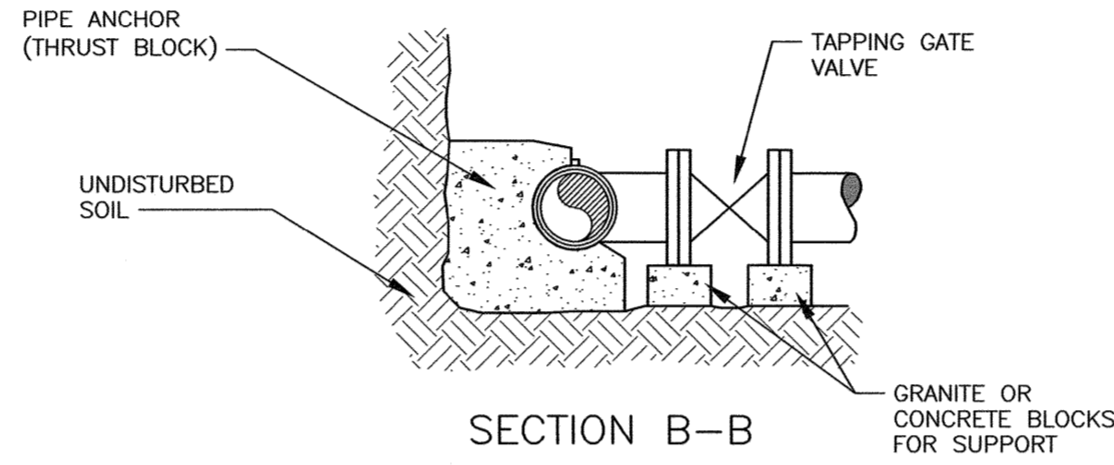

- NOTES:**
- 1) ALL MATERIALS SHALL BE APPROVED BY THE PORTSMOUTH WATER DEPARTMENT PRIOR TO INSTALLATION AND USE.
 - 2) ALL JOINTS SHALL BE MECHANICAL.
 - 3) "CLEAR" DIMENSIONS SHOWN ATE REQUIRED FOR WORKSPACE. NO JOINTS ON PIPE BEING TAPPED WITHIN "CLEAR" AREA.
 - 4) FORD TYPE STAINLESS STEEL TAPPING SADDLES OR APPROVED EQUAL ARE ALSO ACCEPTABLE.

T TAPPING SLEEVE AND GATE
C4 INSTALL PER PORTSMOUTH REQUIREMENTS NTS

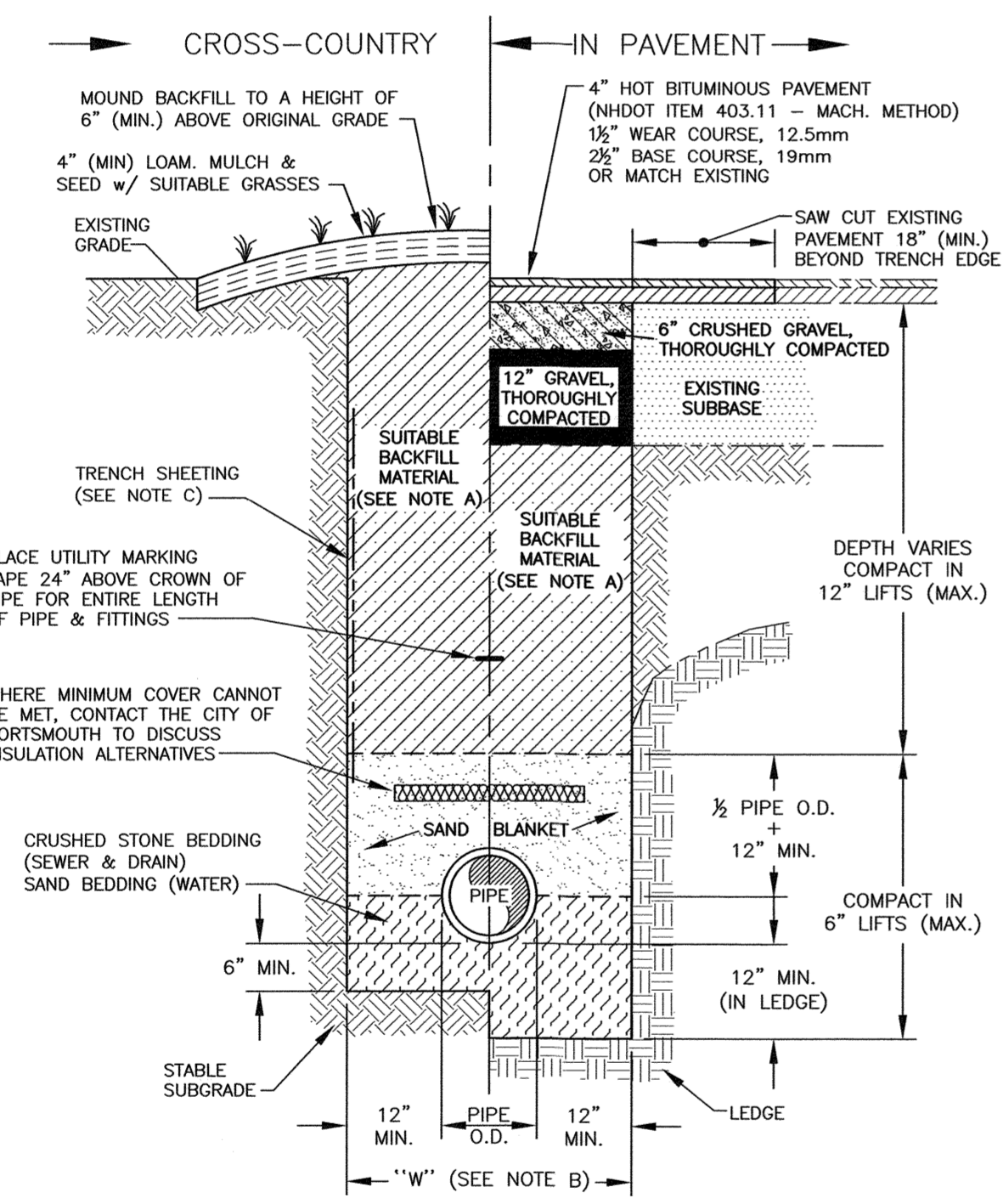

R TYPICAL PIPE TRENCH
C4 NTS

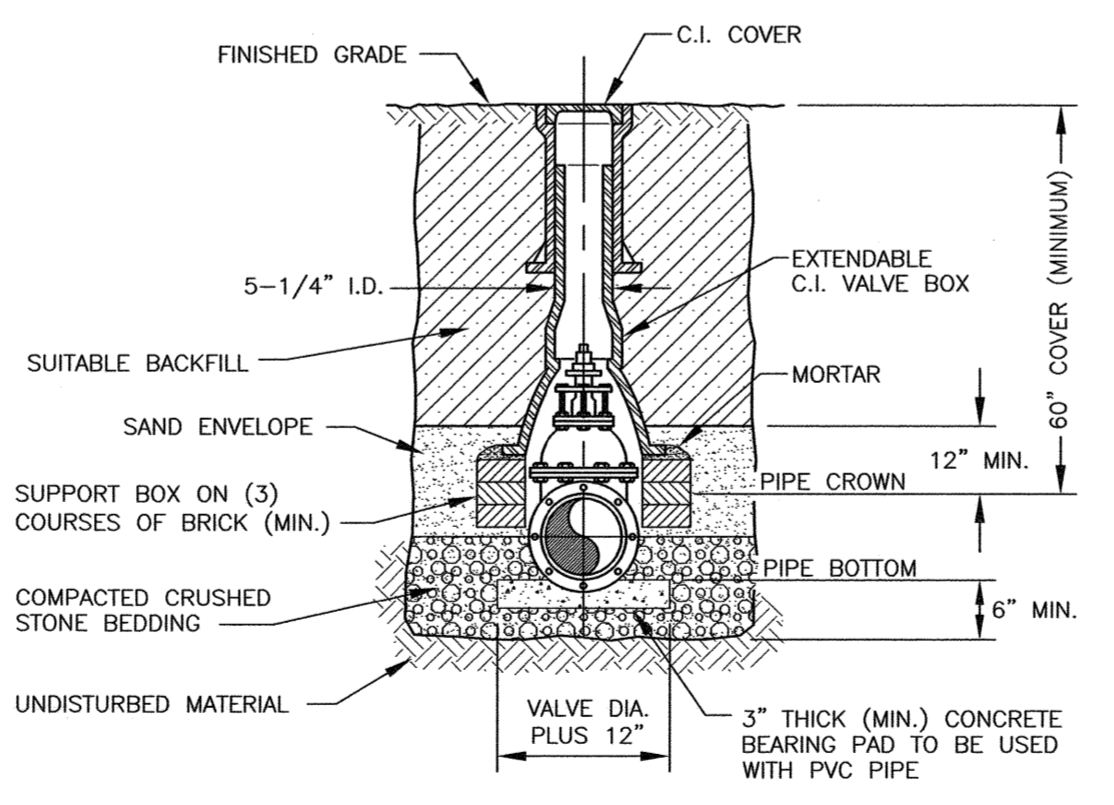

U TYPICAL VALVE BOX INSTALLATION
C4 INSTALL PER PORTSMOUTH REQUIREMENTS NTS

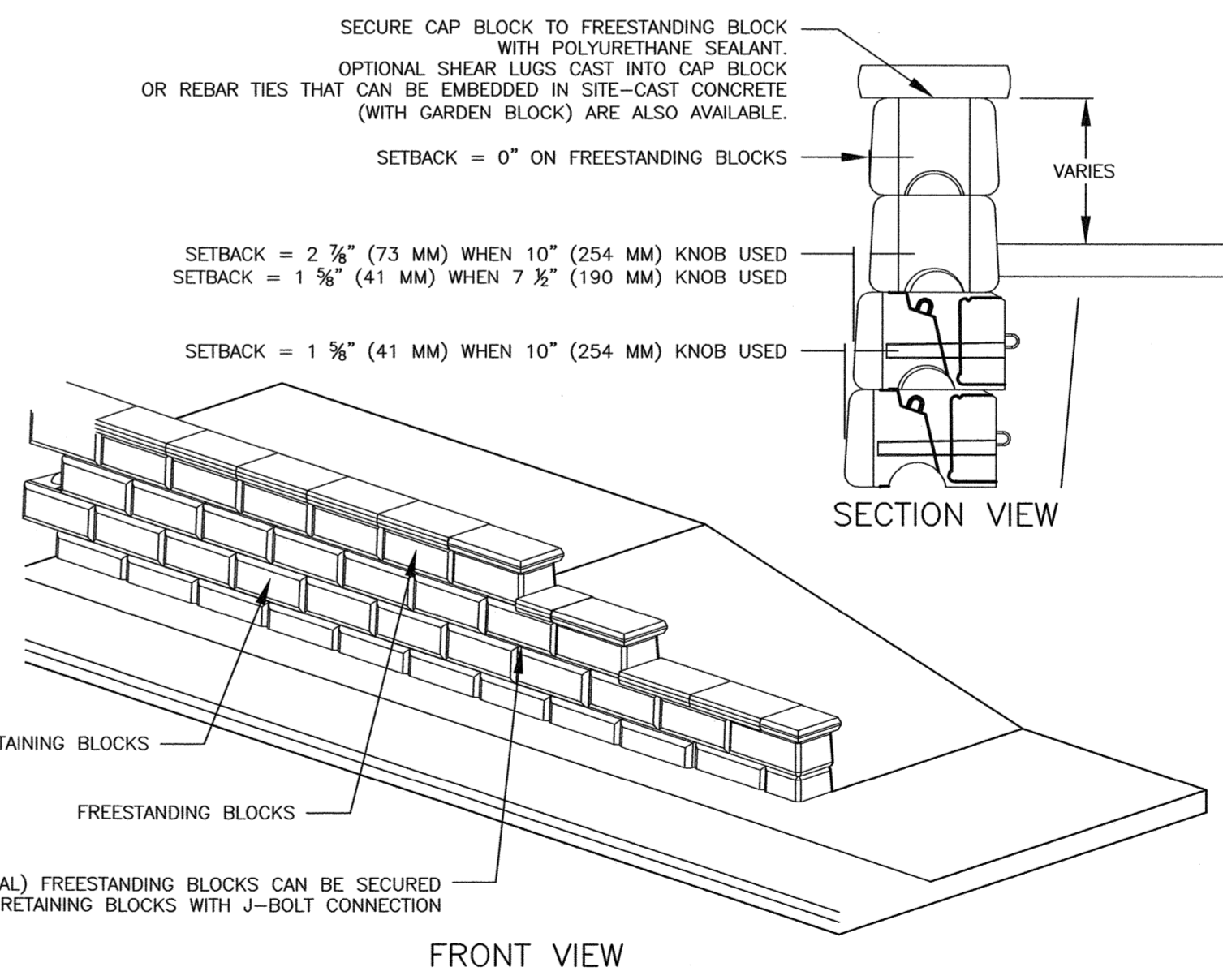

W SMALL BLOCK RETAINING WALL
C3 GENEST - BRUSSELS - UNILOCK WALL COORDINATE COLOR WITH OWNER NTS

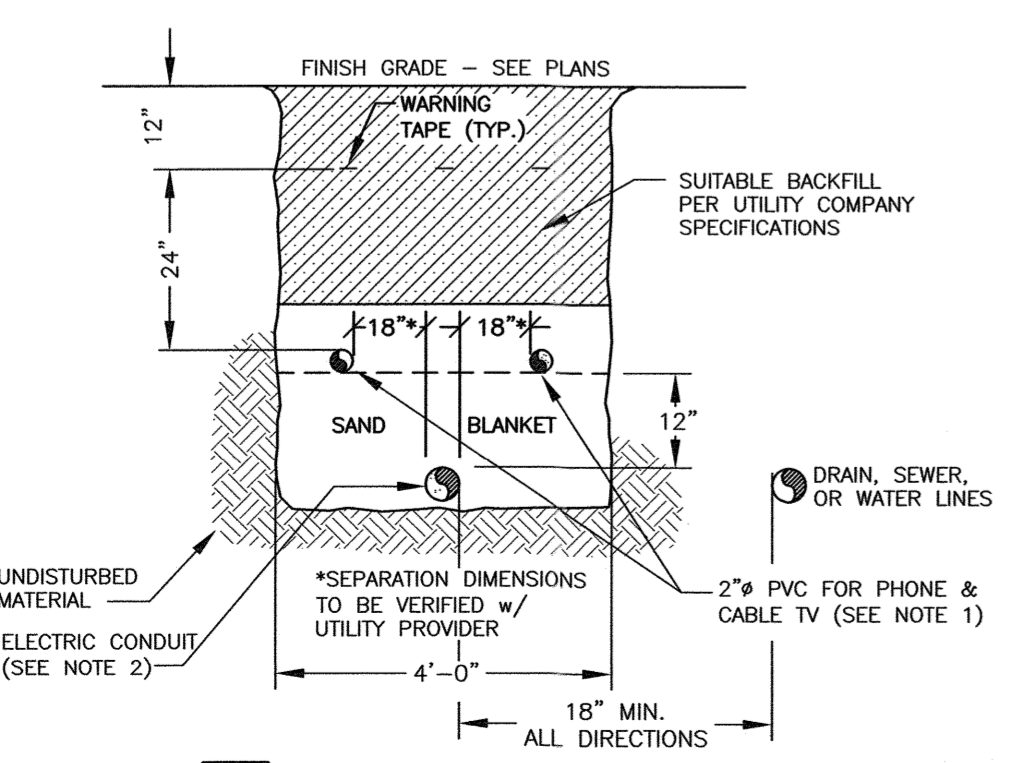

S UTILITY TRENCH ELECTRIC/COMMUNICATIONS
C4 NTS

- NOTES:**
- 1) ALL CONDUIT TO BE U.L. LISTED, SCH. 80 UNDER ALL TRAVEL WAYS, & SCH. 40 FOR THE REMAINDER.
 - 2) NORMAL CONDUIT SIZES FOR PSNH ARE 3 INCH FOR SINGLE PHASE PRIMARY AND SECONDARY VOLTAGE CABLES, 4 INCH FOR THREE PHASE SECONDARY, AND 5 INCH FOR THREE PHASE PRIMARY.
 - 3) ALL WORK TO CONFORM TO THE NATIONAL ELECTRICAL CODE (LATEST REVISION)
 - 4) INSTALL A 200# PULL ROPE FOR EACH CONDUIT
 - 5) VERIFY ALL CONDUIT SPECIFICATIONS WITH UTILITY COMPANIES PRIOR TO ANY CONSTRUCTION.

APPROVED BY THE PORTSMOUTH PLANNING BOARD

CHAIRMAN _____ DATE _____

MIXED USE DEVELOPMENT
581 LAFAYETTE ROAD
PORTSMOUTH, N.H.

NO.	DESCRIPTION	DATE
0	ISSUED FOR COMMENT	11/20/23
REVISIONS		

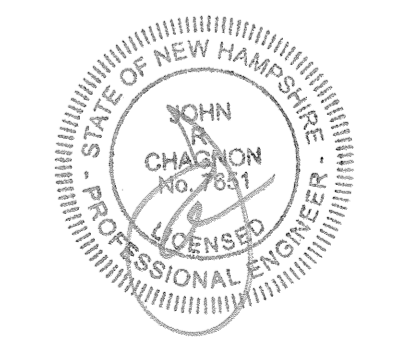

SCALE: AS NOTED NOVEMBER 2023

DETAILS **D3**

JELLYFISH DESIGN NOTES

JELLYFISH TREATMENT CAPACITY IS A FUNCTION OF THE CARTRIDGE LENGTH AND THE NUMBER OF CARTRIDGES. THE STANDARD PEAK DIVERSION STYLE WITH PRECAST TOP SLAB IS SHOWN. ALTERNATE OFFLINE VAULT AND/OR SHALLOW ORIENTATIONS ARE AVAILABLE. PEAK CONVEYANCE CAPACITY TO BE DETERMINED BY ENGINEER OF RECORD.

CARTRIDGE SELECTION	54"	40"	27"	15"
CARTRIDGE LENGTH	6'-4"	6'-4"	4'-3"	3'-3"
OUTLET INVERT TO STRUCTURE INVERT (A)	0.178 / 0.089	0.133 / 0.067	0.089 / 0.045	0.049 / 0.025
FLOW RATE HI-FLO / DRAINDOWN (CFS) PER CART	1.96	1.47	0.98	0.54
MAX. TREATMENT (CFS)	5.00	4.00	4.00	4.00
DECK TO INSIDE TOP (MIN) (B)				

- GENERAL NOTES:**
- CONTECH TO PROVIDE ALL MATERIALS UNLESS NOTED OTHERWISE.
 - FOR SITE SPECIFIC DRAWINGS WITH DETAILED STRUCTURE DIMENSIONS AND WEIGHT, PLEASE CONTACT YOUR CONTECH ENGINEERED SOLUTIONS REPRESENTATIVE. www.conteches.com
 - JELLYFISH WATER QUALITY STRUCTURE SHALL BE IN ACCORDANCE WITH ALL DESIGN DATA AND INFORMATION CONTAINED IN THIS DRAWING. CONTRACTOR TO CONFIRM STRUCTURE MEETS REQUIREMENTS OF PROJECT.
 - STRUCTURE SHALL MEET ASHSTO HS-20 OR PER APPROVING JURISDICTION REQUIREMENTS, WHICHEVER IS MORE STRINGENT, ASSUMING EARTH COVER OF 10' - 12' AND GROUNDWATER ELEVATION AT OR BELOW THE OUTLET PIPE INVERT ELEVATION. ENGINEER OF RECORD TO CONFIRM ACTUAL GROUNDWATER ELEVATION. CASTINGS SHALL MEET ASHSTO M308 LOAD RATING AND BE CAST WITH THE CONTECH LOGO.
 - STRUCTURE SHALL BE PRECAST CONCRETE CONFORMING TO ASTM C-867, ASTM C-918, AND ASHSTO LOAD FACTOR DESIGN METHOD.
 - OUTLET PIPE INVERT IS EQUAL TO THE CARTRIDGE DECK ELEVATION.
 - THE OUTLET PIPE DIAMETER FOR NEW INSTALLATIONS IS RECOMMENDED TO BE ONE PIPE SIZE LARGER THAN THE INLET PIPE AT EQUAL OR GREATER SLOPE.
 - NO PRODUCT SUBSTITUTIONS SHALL BE ACCEPTED UNLESS SUBMITTED 10 DAYS PRIOR TO PROJECT BID DATE, OR AS DIRECTED BY THE ENGINEER OF RECORD.

- INSTALLATION NOTES:**
- ANY SUB-BASE, BACKFILL DEPTH, AND/OR ANTI-FLOTATION PROVISIONS ARE SITE-SPECIFIC DESIGN CONSIDERATIONS AND SHALL BE SPECIFIED BY ENGINEER OF RECORD.
 - CONTRACTOR TO PROVIDE EQUIPMENT WITH SUFFICIENT LIFTING AND REACH CAPACITY TO LIFT AND SET THE STRUCTURE.
 - CONTRACTOR WILL INSTALL AND LEVEL THE STRUCTURE, SEALING THE JOINTS, LINE ENTRY AND EXIT POINTS (NON-SHRINK GROUT WITH APPROVED WATERSTOP OR FLEXIBLE BOOT).
 - CARTRIDGE INSTALLATION, BY CONTECH, SHALL OCCUR ONLY AFTER SITE HAS BEEN STABILIZED AND THE JELLYFISH UNIT IS CLEAN AND FREE OF DEBRIS. CONTACT CONTECH TO COORDINATE CARTRIDGE INSTALLATION WITH SITE STABILIZATION.

SITE SPECIFIC DATA REQUIREMENTS

STRUCTURE ID	ID
WATER QUALITY FLOW RATE (cfs)	WQFLOW
PEAK FLOW RATE (cfs)	PEAK
RETURN PERIOD OF PEAK FLOW (yrs)	RETURN
# OF CARTRIDGES REQUIRED (HF / DD)	CART
CARTRIDGE LENGTH	SIZE
PIPE DATA: IE MATL DIA SLOPE % HGL	
INLET #1 ELEV MATL DIA SLOPE HGL	
INLET #2 ELEV MATL DIA SLOPE HGL	
OUTLET ELEV MATL DIA SLOPE HGL	
SEE GENERAL NOTES 6-7 FOR INLET AND OUTLET HYDRAULIC AND SIZING REQUIREMENTS	
RIM ELEVATION	RIM ELEV
ANTI-FLOTATION BALLAST	WIDTH HEIGHT
	WIDTH HEIGHT
NOTES/SPECIAL REQUIREMENTS:	
* PER ENGINEER OF RECORD	

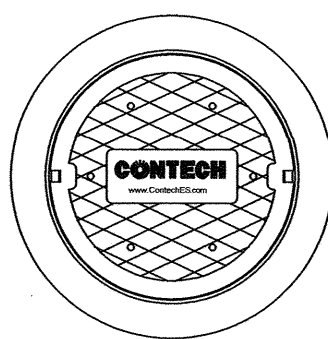

FRAME AND COVER
(DIAMETER VARIES)
N.T.S.

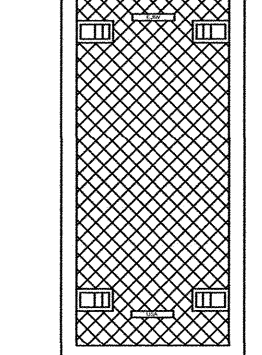

24" TRENCH COVER
(LENGTH VARIES)
N.T.S.

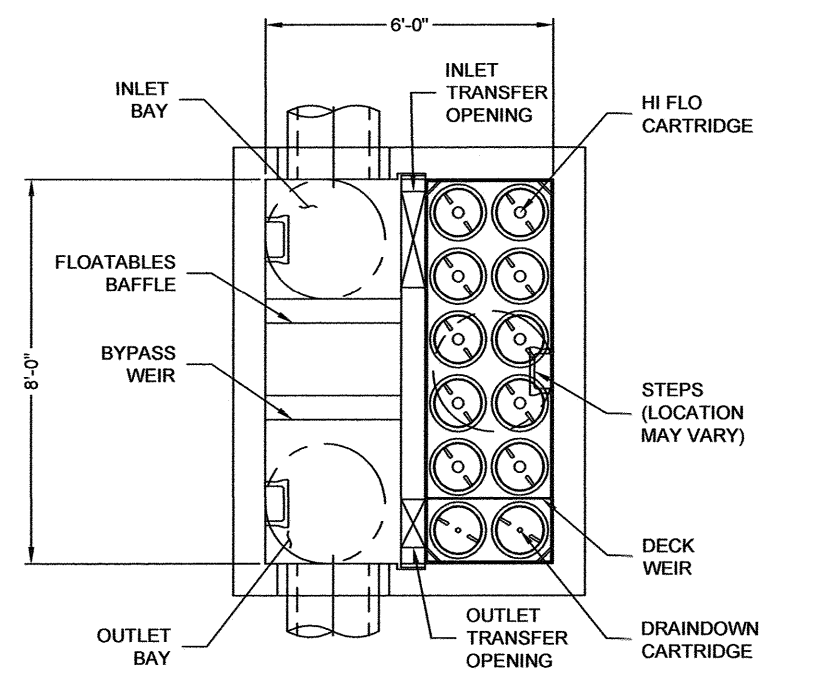

PLAN VIEW
(TOP SLAB NOT SHOWN FOR CLARITY)

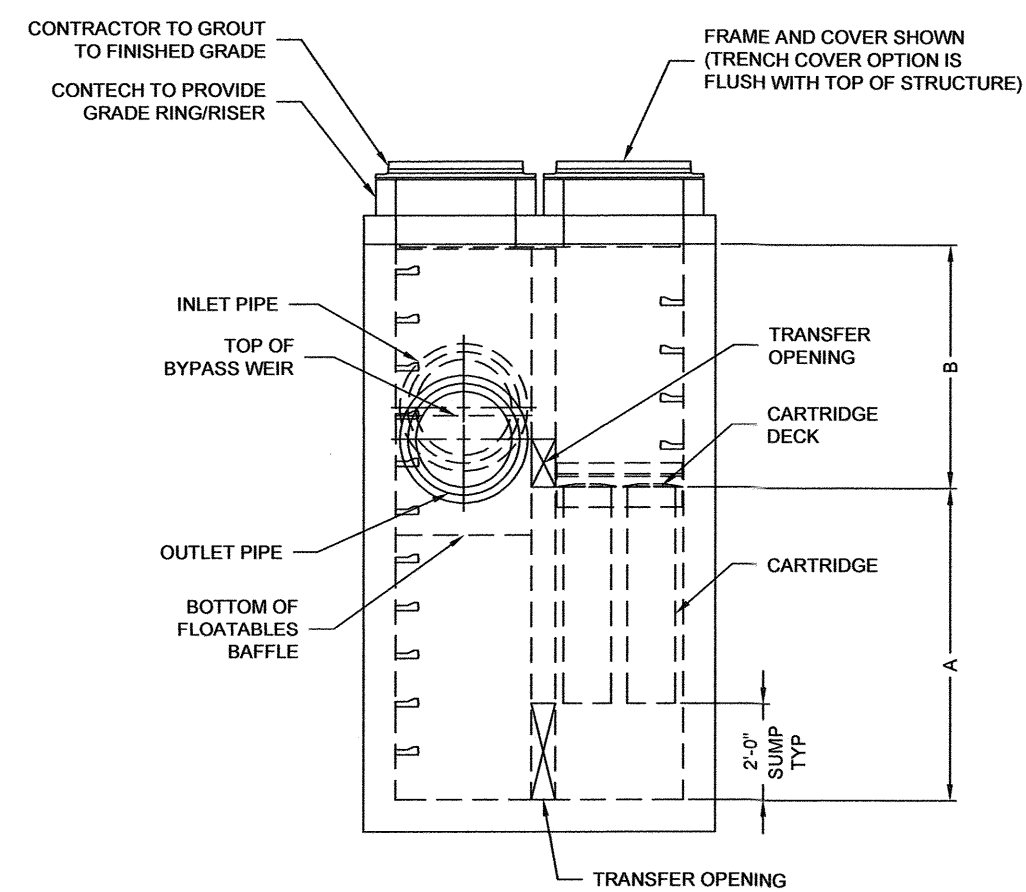

ELEVATION VIEW

JELLYFISH FILTER DETAIL

N.T.S.

1.0 Inspection and Maintenance Overview

The primary purpose of the Jellyfish® Filter is to capture and remove pollutants from stormwater runoff. As with any filtration system, these pollutants must be removed to maintain the filter's maximum treatment performance. Regular inspection and maintenance are required to insure proper functioning of the system.

Maintenance frequencies and requirements are site specific and vary depending on pollutant loading. Additional maintenance activities may be required in the event of non-storm event runoff, such as base-flow or seasonal flow, an upstream chemical spill or due to excessive sediment loading from site erosion or extreme runoff events. It is a good practice to inspect the system after major storm events.

Inspection activities are typically conducted from surface observations and include:

- Observe if standing water is present
- Observe if there is any physical damage to the deck or cartridge lids
- Observe the amount of debris in the Maintenance Access Wall (MAW) or inlet bay for vault systems

Maintenance activities include:

- Removal of oil, floatable trash and debris
- Removal of collected sediments
- Rinsing and re-installing the filter cartridges
- Replace filter cartridge tentacles, as needed

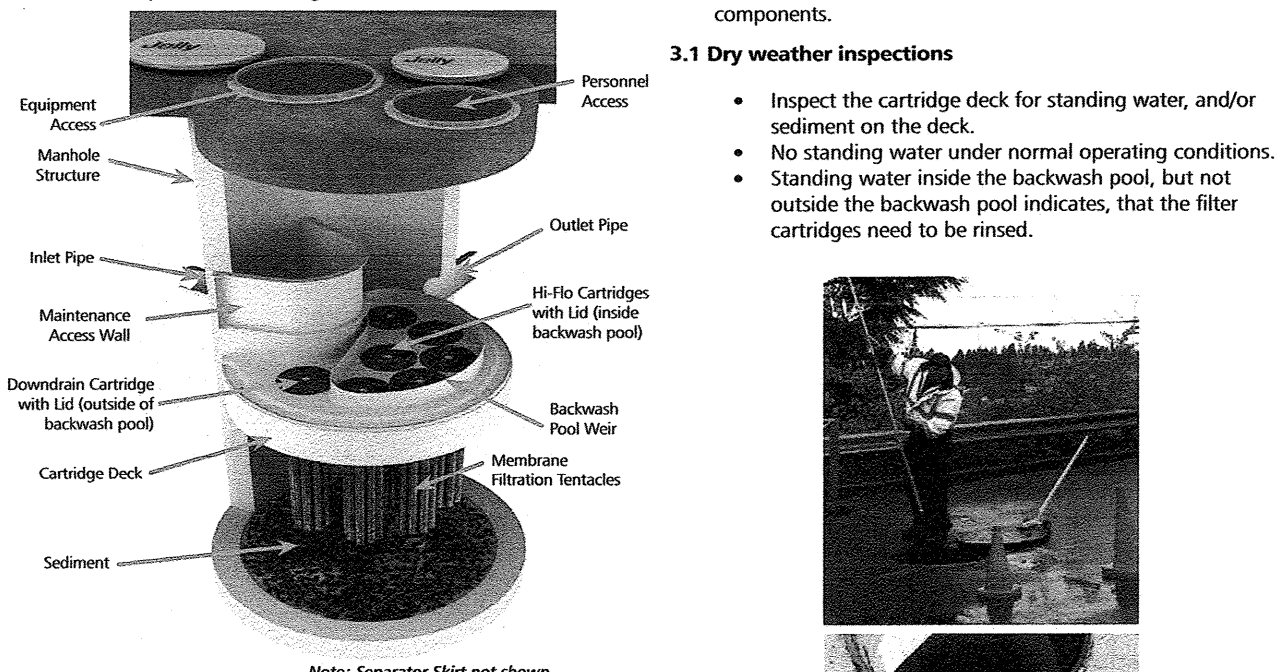

2.0 Inspection Timing

Inspection of the Jellyfish Filter is key in determining the maintenance requirements for, and to develop a history of, the site's pollutant loading characteristics. In general, inspections should be performed at the times indicated below, or per the approved project stormwater quality documents (if applicable), whichever is more frequent.

- Collected rinse water is typically removed by vacuum hose.
- Reassemble cartridges as detailed later in this document. Reuse O-rings and nuts, ensuring proper placement on each tentacle.

5.3 Sediment and Floatables Extraction

- Perform vacuum cleaning of the Jellyfish Filter only after filter cartridges have been removed from the system. Access the lower chamber for vacuum cleaning only through the maintenance access wall (MAW) opening. Be careful not to damage the flexible plastic separator skirt that is attached to the underside of the deck on manhole systems. Do not lower the vacuum wand through a cartridge receptacle, as damage to the receptacle will result.
- Vacuum floatable trash, debris, and oil, from the MAW opening or inlet bay. Alternatively, floatable solids may be removed by a net or skimmer.

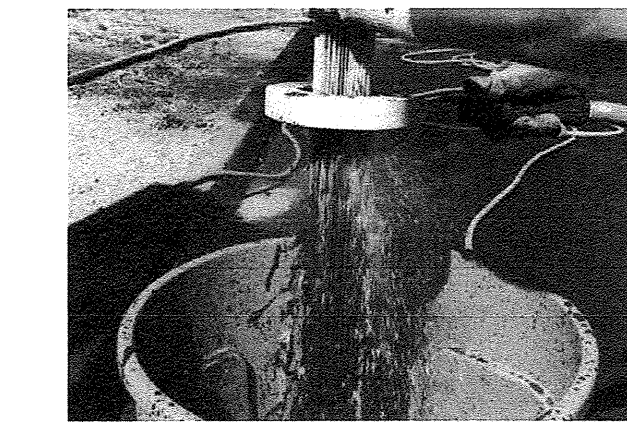

Vacuuming Sump Through MAW

- Pressure wash cartridge deck and receptacles to remove all sediment and debris. Sediment should be rinsed into the sump area. Take care not to flush rinse water into the outlet pipe.
- Remove water from the sump area. Vacuum or pump equipment should only be introduced through the MAW or inlet bay.
- Remove the sediment from the bottom of the unit through the MAW or inlet bay opening.

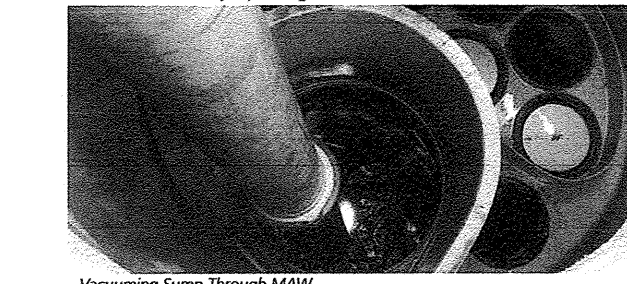

Vacuuming Sump Through MAW

- A minimum of quarterly inspections during the first year of operation to assess the sediment and floatable pollutant accumulation, and to ensure proper functioning of the system.
- Inspection frequency in subsequent years is based on the inspection and maintenance plan developed in the first year of operation. Minimum frequency should be once per year.
- Inspection is recommended after each major storm event.
- Inspection is required immediately after an upstream oil, fuel or other chemical spill.

3.0 Inspection Procedure

The following procedure is recommended when performing inspections:

- Provide traffic control measures as necessary.
- Inspect the MAW or inlet bay for floatable pollutants such as trash, debris, and oil sheen.
- Measure oil and sediment depth in several locations, by lowering a sediment probe until contact is made with the floor of the structure. Record sediment depth, and presences of any oil layers.
- Inspect cartridge lids. Missing or damaged cartridge lids to be replaced.
- Inspect the MAW (where appropriate), cartridge deck and receptacles, and backwash pool weir, for damaged or broken components.

3.1 Dry weather inspections

- Inspect the cartridge deck for standing water, and/or sediment on the deck.
- No standing water under normal operating conditions.
- Standing water inside the backwash pool, but not outside the backwash pool indicates, that the filter cartridges need to be rinsed.

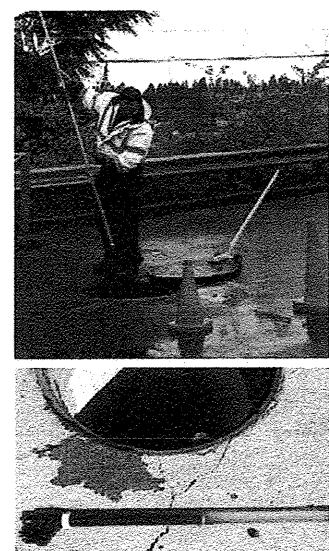

Inspection Utilizing Sediment Probe

3

- Standing water outside the backwash pool is not anticipated and may indicate a backwater condition caused by high water elevation in the receiving water body, or possibly a blockage in downstream infrastructure.
- Any appreciable sediment (≥1/16") accumulated on the deck surface should be removed.

3.2 Wet weather inspections

- Observe the rate and movement of water in the unit. Note the depth of water above deck elevation within the MAW or inlet bay.
- Less than 6 inches, flow should be exiting the cartridge lids of each of the draindown cartridges (i.e. cartridges located outside the backwash pool).
- Greater than 6 inches, flow should be exiting the cartridge lids of each of the draindown cartridges and each of the hi-flo cartridges (i.e. cartridges located inside the backwash pool), and water should be overflowing the backwash pool weir.
- 18 inches or greater and relatively little flow is exiting the cartridge lids and outlet pipe, this condition indicates that the filter cartridges need to be rinsed.

4.0 Maintenance Requirements

Required maintenance for the Jellyfish Filter is based upon results of the most recent inspection, historical maintenance records, or the site specific water quality management plan, whichever is more frequent. In general, maintenance requires some combination of the following:

- Sediment removal for depths reaching 12 inches or greater, or within 3 years of the most recent sediment cleaning, whichever occurs sooner.
- Floatable trash, debris, and oil removal.
- Deck cleaned and free from sediment.
- Filter cartridges rinsed and re-installed as required by the most recent inspection results, or within 12 months of the most recent filter rinsing, whichever occurs sooner.
- Replace tentacles if rinsing does not restore adequate hydraulic capacity, remove accumulated sediment, or if damaged or missing. It is recommended that tentacles should remain in service no longer than 5 years before replacement.
- Damaged or missing cartridge deck components must be repaired or replaced as indicated by results of the most recent inspection.
- The unit must be cleaned out and filter cartridges inspected immediately after an upstream oil, fuel, or chemical spill. Filter cartridge tentacles should be replaced if damaged or compromised by the spill.

5.0 Maintenance Procedure

The following procedures are recommended when maintaining the Jellyfish Filter:

- Provide traffic control measures as necessary.
- Open all covers and hatches. Use ventilation equipment as required, according to confined space entry procedures. **Caution: Dropping objects onto the cartridge deck may cause damage.**
-
-

Jellyfish Filter Components & Filter Cartridge Assembly and Installation

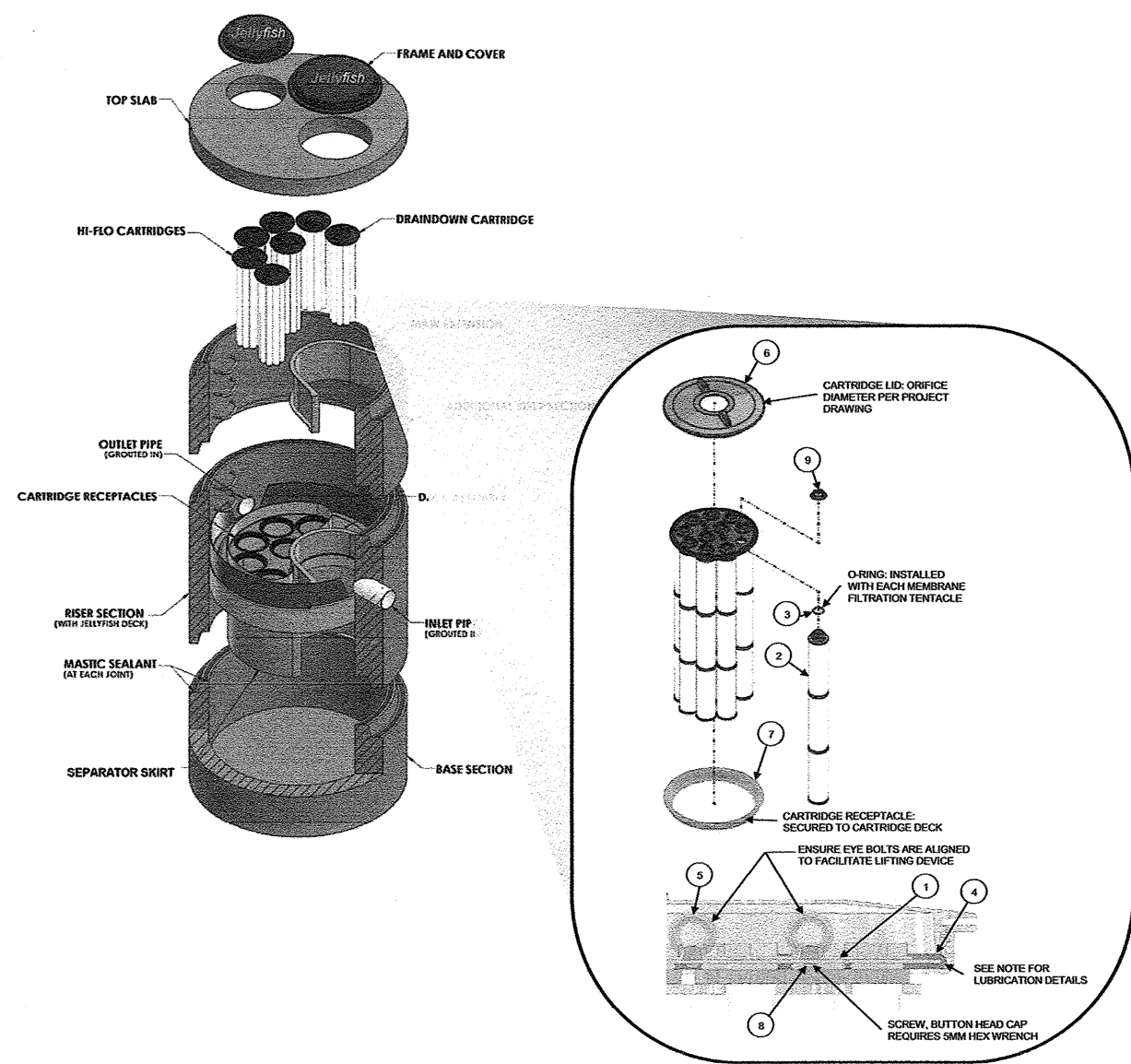

TABLE 1: BOM

ITEM NO.	DESCRIPTION
1	JF HEAD PLATE
2	JF TENTACLE
3	JF O-RING
4	JF HEAD PLATE GASKET
5	JF CARTRIDGE EYELET
6	JF 1/4" COVER
7	JF 1/4" NUT
8	JF HEAD CAP
9	JF CARTRIDGE NUT

TABLE 2: APPROVED GASKET LUBRICANTS

PART NO.	MFR.	DESCRIPTION
78713	LA-CO	LUBR-JOINT
40501	HERCULES	DOCK BUTTER
35600	QATEY	PIPE LUBRICANT
PROJUBO-10	PROJSELECT	PIPE JOINT LUBRICANT

NOTES:

Head Plate Gasket Installation:
Install Head Plate Gasket (Item 4) onto the Head Plate (Item 1) and liberally apply a lubricant from Table 2. Approved Gasket Lubricants onto the gasket where it contacts the Receptacle (Item 7) and Cartridge Lid (Item 6). Follow Lubricant manufacturer's instructions.

Lid Assembly:

Rotate Cartridge Lid counter-clockwise until both male threads drop down and properly seat. Then rotate Cartridge Lid clockwise approximately one-third of a full rotation until Cartridge Lid is firmly secured, creating a watertight seal.



WWW.HALEYWARD.COM

200 Griffin Road, Unit 3
Portsmouth, NH 03801
603.430.9262

NOTES:

- THE CONTRACTOR SHALL NOTIFY DIG SAFE AT 1-888-DIG-SAFE (1-888-344-7233) AT LEAST 72 HOURS PRIOR TO COMMENCING ANY EXCAVATION ON PUBLIC OR PRIVATE PROPERTY.
- UNDERGROUND UTILITY LOCATIONS ARE BASED UPON BEST AVAILABLE EVIDENCE AND ARE NOT FIELD VERIFIED. LOCATING AND PROTECTING ANY ABOVEGROUND OR UNDERGROUND UTILITIES IS THE SOLE RESPONSIBILITY OF THE CONTRACTOR AND/OR THE OWNER. UTILITY CONFLICTS SHOULD BE REPORTED AT ONCE TO THE DESIGN ENGINEER.
- CONTRACTOR SHALL INSTALL AND MAINTAIN EROSION CONTROL MEASURES IN ACCORDANCE WITH THE "NEW HAMPSHIRE EROSION AND SEDIMENT CONTROL BMP'S" PUBLISHED BY THE NEW HAMPSHIRE D.E.S. IN 2008.

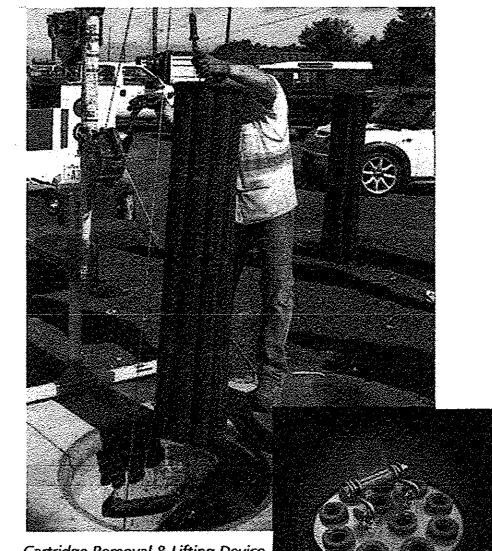

Cartridge Removal & Lifting Device

- Position tentacles in a container (or over the MAW), with the threaded connector (open end) facing down, so rinse water is flushed through the membrane and captured in the container.
- Using the Jellyfish rinse tool (available from Contech) or a low-pressure garden hose sprayer, direct water spray onto the tentacle membrane, sweeping from top to bottom along the length of the tentacle. Rinse until all sediment is removed from the membrane. **Caution: Do not use a high pressure sprayer or focused stream of water on the membrane. Excessive water pressure may damage the membrane.**

APPROVED BY THE PORTSMOUTH PLANNING BOARD

CHAIRMAN

DATE

MIXED USE DEVELOPMENT
581 LAFAYETTE ROAD
PORTSMOUTH, N.H.

NO.	DESCRIPTION	DATE
0	ISSUED FOR COMMENT	11/20/23
REVISIONS		

SCALE: AS NOTED NOVEMBER 2023

JELLYFISH DETAILS

D4

NOTES:

- 1) UNDERGROUND UTILITY LOCATIONS ARE BASED UPON BEST AVAILABLE EVIDENCE AND ARE NOT FIELD VERIFIED. LOCATING AND PROTECTING ANY ABOVEGROUND OR UNDERGROUND UTILITIES IS THE SOLE RESPONSIBILITY OF THE CONTRACTOR AND/OR THE OWNER. UTILITY CONFLICTS SHOULD BE REPORTED AT ONCE TO THE DESIGN ENGINEER.
- 2) THE CONTRACTOR SHALL NOTIFY DIG SAFE AT 1-888-DIG-SAFE (1-888-344-7233) AT LEAST 72 HOURS PRIOR TO COMMENCING ANY EXCAVATION ON PUBLIC OR PRIVATE PROPERTY.
- 3) CONTRACTOR SHALL INSTALL AND MAINTAIN EROSION CONTROL MEASURES IN ACCORDANCE WITH THE "NEW HAMPSHIRE STORMWATER MANUAL, VOLUME 3, EROSION AND SEDIMENT CONTROLS DURING CONSTRUCTION. (NHDES DECEMBER 2008).

MANHOLE NOTES

- 1) IT IS THE INTENTION THAT THE MANHOLE, INCLUDING ALL COMPONENT PARTS, HAVE ADEQUATE SPACE, STRENGTH AND LEAK PROOF QUALITIES CONSIDERED NECESSARY FOR THE INTENDED SERVICE. SPACE REQUIREMENTS AND CONFIGURATIONS, SHALL BE AS SHOWN ON THE DRAWING. MANHOLES SHALL BE AN ASSEMBLY OF PRECAST SECTIONS, WITH STEEL REINFORCEMENT, WITH ADEQUATE JOINTING, OR CONCRETE CAST MONOLITHICALLY IN PLACE WITH REINFORCEMENT. IN ANY APPROVED MANHOLE, THE COMPLETE STRUCTURE SHALL BE OF SUCH MATERIAL AND QUALITY AS TO WITHSTAND LOADS OF 8 TONS (H-20 LOADING) WITHOUT FAILURE AND PREVENT LEAKAGE IN EXCESS OF ONE GALLON PER DAY PER VERTICAL FOOT OF MANHOLE, CONTINUOUSLY FOR THE LIFE OF THE STRUCTURE. A PERIOD GENERALLY IN EXCESS OF 25 YEARS IS TO BE UNDERSTOOD IN BOTH CASES.
- 2) BARRELS AND CONE SECTIONS SHALL BE PRECAST REINFORCED CONCRETE, OR POURED IN PLACE REINFORCED CONCRETE IF POURED AS A COMPLETE MANHOLE.
- 3) PRECAST CONCRETE BARREL SECTIONS, CONES AND BASES SHALL CONFORM TO ASTM C478.
- 4) LEAKAGE TEST MAY NOT BE FEASIBLE, BUT SHALL CONFORM TO ENV-WQ 704.10(X) THROUGH ENV-WQ 704.10(Z).
- 5) INVERTS AND SHELVES: MANHOLES SHALL HAVE A BRICK PAVED SHELF AND INVERT, CONSTRUCTED TO CONFORM TO THE SIZE OF THE PIPE AND FLOW. AT CHANGES IN DIRECTIONS, THE INVERTS SHALL BE LAID OUT IN CURVES OF THE LONGEST RADIUS POSSIBLE AND TANGENT TO THE CENTERLINE OF THE SEWER PIPES. SHELVES SHALL BE CONSTRUCTED TO THE ELEVATION OF THE HIGHEST PIPE CROWN AND SLOPED TO DRAIN TOWARD FLOWING THROUGH CHANNEL. UNDERLAYMENT OF INVERT AND SHELF SHALL CONSIST OF BRICK MASONRY.
- 6) FRAMES AND COVERS: MANHOLE FRAMES AND COVERS SHALL BE OF HEAVY DUTY DESIGN AND PROVIDE A 30-INCH CLEAR OPENING. A THREE INCH (MINIMUM HEIGHT) WORD "SEWER" FOR SEWERS AND "DRAIN" FOR DRAINS SHALL BE PLAINLY CAST INTO THE CENTER OF EACH COVER. CASTINGS SHALL CONFORM TO CLASS 30, ASTM A48.
- 7) BEDDING: SCREENED GRAVEL AND/OR CRUSHED STONE, FREE FROM CLAY, LOAM, ORGANIC MATTER AND MEETING ASTM C33 STONE SIZE NO. 67.

100% PASSING	1 INCH SCREEN
90%-100% PASSING	3/4 INCH SCREEN
20%- 55% PASSING	3/8 INCH SCREEN
0%- 10% PASSING	#4 SIEVE
0%- 5% PASSING	#8 SIEVE

WHEN ORDERED BY THE ENGINEER TO STABILIZE THE BASE, SCREENED GRAVEL OR CRUSHED STONE 1/2 INCH TO 1-1/2 INCH SHALL BE USED.

- 8) FLEXIBLE JOINT: A FLEXIBLE JOINT SHALL BE PROVIDED WITHIN THE FOLLOWING DISTANCES:
RCP & CI PIPE - ALL SIZES - 48"

- 9) SHALLOW MANHOLE: IN LIEU OF A CONE SECTION, WHEN MANHOLE DEPTH IS LESS THAN 6 FEET, A REINFORCED CONCRETE SLAB COVER MAY BE USED HAVING AN ECCENTRIC ENTRANCE OPENING AND CAPABLE OF SUPPORTING H-20 LOADS.

- 10) HORIZONTAL JOINTS BETWEEN SECTIONS OF PRECAST CONCRETE BARRELS SHALL BE OF A TYPE APPROVED BY THE ENGINEER, WHICH TYPE SHALL, IN GENERAL, DEPEND FOR WATER TIGHTNESS UPON AN ELASTOMERIC OR MASTIC-LIKE GASKET, IN 2 ROWS. APPROVED ELASTOMERIC SEALANTS ARE:

RAM-NEK	1 INCH SCREEN
KENT SEAL NO. 2	3/4 INCH SCREEN
EZ	3/8 INCH SCREEN
	#4 SIEVE
	#10 SIEVE

- 11) PIPE TO MANHOLE JOINTS SHALL BE ONLY AS APPROVED BY THE ENGINEER AND IN GENERAL, WILL DEPEND FOR WATER TIGHTNESS UPON EITHER AN APPROVED NON-SHRINKING MORTAR OR ELASTOMERIC SEALANT.

- 12) THE PURPOSE OF THIS PLAN IS TO SHOW STANDARDS FOR SEWER CONSTRUCTION.

- 13) ALL WORK SHALL BE IN COMPLIANCE WITH NHDES CODE OF ADMINISTRATIVE RULES PART ENV-WQ 704 DESIGN OF SEWERS.

- 14) BASE SECTIONS SHALL BE OF MONOLITHIC CONSTRUCTION TO A POINT AT LEAST 6 INCHES ABOVE THE CROWN OF THE LARGEST INCOMING PIPE.

GENERAL NOTES

- 1) MINIMUM PIPE SIZE FOR HOUSE SERVICE SHALL BE FOUR INCHES.

- 2) PIPE AND JOINT MATERIALS:

A. PLASTIC SEWER PIPE

1. PIPE AND FITTINGS SHALL CONFORM TO THE FOLLOWING ASTM STANDARDS:

ASTM STANDARDS	GENERIC PIPE MATERIAL	SIZES APPROVED
D3034	*PVC (SOLID WALL)	8" THROUGH 15" (SDR 35)
F679	PVC (SOLID WALL)	18" THROUGH 27" (T-1 & T-2)
F789	PVC (SOLID WALL)	4" THROUGH 18" (T-1 TO T-3)
F794	PVC (RIBBED WALL)	8" THROUGH 36"
AWWA C900	PVC (SOLID WALL)	8" THROUGH 18"

*PVC: POLYVINYL CHLORIDE

2. JOINT SEALS FOR PVC PIPE SHALL BE OIL RESISTANT COMPRESSION RINGS OF ELASTOMERIC MATERIAL CONFORMING TO ASTM D-3212 AND SHALL BE PUSH-ON BELL AND SPIGOT TYPE.

- 3) DAMAGED PIPE SHALL BE REJECTED AND REMOVED FROM THE JOB SITE.

- 4) JOINTS SHALL BE DEPENDENT UPON A NEOPRENE OR ELASTOMERIC GASKET FOR WATER TIGHTNESS. ALL JOINTS SHALL BE PROPERLY MATCHED WITH THE PIPE MATERIALS USED. WHERE DIFFERING MATERIALS ARE TO BE CONNECTED, AS AT THE STREET SEWER WYE OR AT THE FOUNDATION WALL, APPROPRIATE MANUFACTURED ADAPTERS SHALL BE USED.

- 5) HOUSE SEWER INSTALLATION: THE PIPE SHALL BE HANDLED, PLACED AND JOINTED IN ACCORDANCE WITH INSTALLATION GUIDES OF THE APPROPRIATE MANUFACTURER. IT SHALL BE CAREFULLY BEDDED ON A 4 INCH LAYER OF CRUSHED STONE AND/OR GRAVEL AS SPECIFIED IN NOTE 10. BEDDING AND REFILL FOR DEPTH OF 12 INCHES ABOVE THE TOP OF THE PIPE SHALL BE CAREFULLY AND THOROUGHLY TAMPED BY HAND OR WITH APPROPRIATE MECHANICAL DEVICES.

- 6) THE PIPE SHALL BE LAID AT A CONTINUOUS AND CONSTANT GRADE FROM THE STREET SEWER CONNECTION TO THE FOUNDATION AT A GRADE OF NOT LESS THAN 1/4 INCH PER FOOT. PIPE JOINTS MUST BE MADE UNDER DRY CONDITIONS. IF WATER IS PRESENT, ALL NECESSARY STEPS SHALL BE TAKEN TO DEWATER THE TRENCH.

- 7) TESTING: WHEN REQUIRED BY THE GOVERNING AUTHORITY, TESTING SHALL CONFORM TO ENV-WQ 704.07.

- 8) ILLEGAL CONNECTIONS: NOTHING BUT SANITARY WASTE FLOW FROM HOUSE TOILETS, SINKS, LAUNDRY ETC. SHALL BE PERMITTED. ROOF LEADERS, FOOTING DRAINS, SUMP PUMPS OR OTHER SIMILAR CONNECTIONS CARRYING RAIN WATER, DRAINAGE OR GROUND WATER SHALL NOT BE PERMITTED.

- 9) HOUSE WATER SERVICE SHALL NOT BE LAID IN SAME TRENCH AS SEWER SERVICE, UNLESS IT IS ON A SHELF 12" HIGHER, AND 18" APART.

- 10) BEDDING: PROCESSED GRAVEL OR CRUSHED STONE, FREE FROM CLAY, LOAM, ORGANIC MATTER AND MEETING THE FOLLOWING GRADATION (ALL STONE MUST HAVE AT LEAST 2 FRACTURED FACES):

100% PASSING	1 INCH SCREEN
90%-100% PASSING	3/4 INCH SCREEN
0%- 75% PASSING	3/8 INCH SCREEN
0%- 25% PASSING	#4 SIEVE
0%- 5% PASSING	#10 SIEVE

WHEN ORDERED BY THE ENGINEER, OVEREXCAVATE UNSTABLE TRENCH BOTTOM AND BACKFILL WITH CRUSHED STONE.

- 11) LOCATION: THE LOCATION OF THE TEE OR WYE SHALL BE RECORDED AND FILED IN THE MUNICIPAL RECORDS. IN ADDITION, A FERROUS METAL ROD OR PIPE SHALL BE PLACED OVER THE TEE OR WYE AS DESCRIBED IN THE TYPICAL "CHIMNEY" DETAIL, TO AID IN LOCATING THE BURIED PIPE WITH A DIP NEEDLE OR PIPE FINDER.

- 12) CAST-IN-PLACE CONCRETE: SHALL CONFORM TO THE REQUIREMENTS FOR CLASS A (3000 PSI) CONCRETE OF THE NEW HAMPSHIRE DEPARTMENT OF TRANSPORTATION STANDARD SPECIFICATIONS AS FOLLOWS:

CEMENT:	6.0 BAGS PER CUBIC YARD
WATER:	5.75 GALLONS PER BAG OF CEMENT
MAXIMUM AGGREGATE SIZE:	3/4 INCH

- 13) BACKFILL UP TO SUBBASE GRAVEL SHALL BE WITH EXCAVATED SOIL FROM TRENCHING OPERATIONS. COMPACT IN 8" LIFTS WITH VIBRATORY PLATE COMPACTORS TO 90% OF MODIFIED PROCTOR DENSITY. IF FINE-GRAINED, COMPACT WITH POGO STICKS OR SHEEPSFOOT ROLLERS. PLACE NO LARGE ROCKS WITHIN 24" OF PIPE. TRENCHES THAT ARE NOT ADEQUATELY COMPACTED SHALL BE RE-EXCAVATED AND BACKFILLED UNDER THE SUPERVISION OF THE DESIGN ENGINEER OR GOVERNING BODY. UNSUITABLE BACKFILL MATERIAL INCLUDES CHUNKS OF PAVEMENT, TOPSOIL, ROCKS OVER 6" IN SIZE, MUCK, PEAT OR PIECES OF PAVEMENT.

- 14) THE CONTRACTOR IS SOLELY RESPONSIBLE FOR JOB-SITE SAFETY AND COMPLIANCE WITH GOVERNING REGULATIONS.

- 15) ORDERED EXCAVATION OF UNSUITABLE MATERIAL BELOW GRADE. REFILL WITH BEDDING MATERIAL FOR TRENCH WIDTH SEE TRENCH DETAIL.

- 16) SAND BLANKET: CLEAN SAND, FREE FROM ORGANIC MATTER, SO GRADED THAT 90% - 100% PASSES A 1/2 INCH SIEVE AND NOT MORE THAN 15% WILL PASS A #200 SIEVE. BLANKET MAY BE OMITTED FOR DUCTILE IRON AND REINFORCED CONCRETE PIPE PROVIDED THAT NO STONE LARGER THAN 2 INCHES IS IN CONTACT WITH THE PIPE.

- 17) BASE COURSE GRAVEL, IF ORDERED BY THE ENGINEER, SHALL MEET THE REQUIREMENTS OF DIVISION 300 OF THE LATEST EDITION OF THE:

STANDARD SPECIFICATIONS FOR ROAD AND BRIDGE CONSTRUCTION OF THE STATE OF NEW HAMPSHIRE, DEPARTMENT OF TRANSPORTATION.

- 18) IF FULL ENCASEMENT IS UTILIZED, DEPTH OF CONCRETE BELOW PIPE SHALL BE 1/4 I.D. (4" MIN.) BLOCK SUPPORT SHALL BE SOLID CONCRETE BLOCKS.

- 19) THE CONTRACTOR SHALL NOTIFY DIG SAFE AT 1-888-DIG-SAFE (1-888-344-7233) AT LEAST 72 HOURS PRIOR TO COMMENCING ANY EXCAVATION.

- 20) THE PURPOSE OF THIS PLAN IS TO SHOW STANDARDS FOR SEWER CONSTRUCTION.

- 21) ALL WORK SHALL BE IN COMPLIANCE WITH NHDES CODE OF ADMINISTRATIVE RULES PART ENV-WQ 704 DESIGN OF SEWERS.

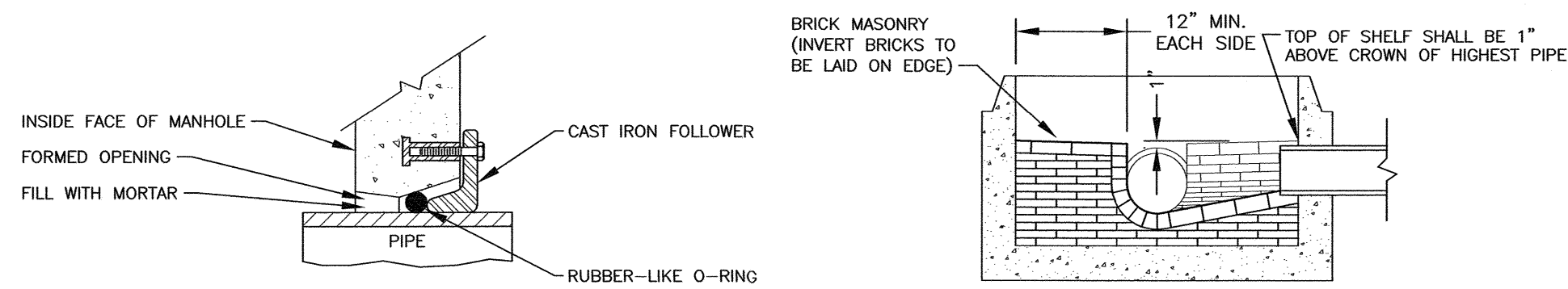

RES-SEAL
(OR ACCEPTABLE SUBSTITUTE)

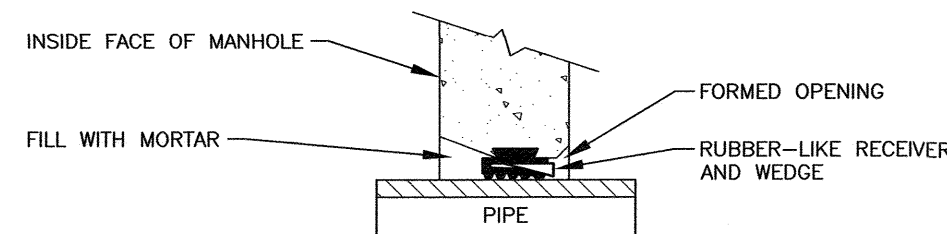

PRESS-WEDGE II
(OR ACCEPTABLE SUBSTITUTE)

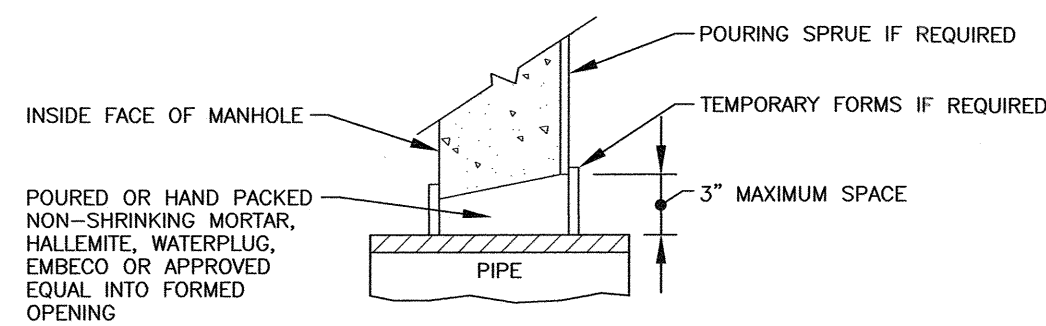

NON-SHRINKING MORTAR
(OR ACCEPTABLE SUBSTITUTE)

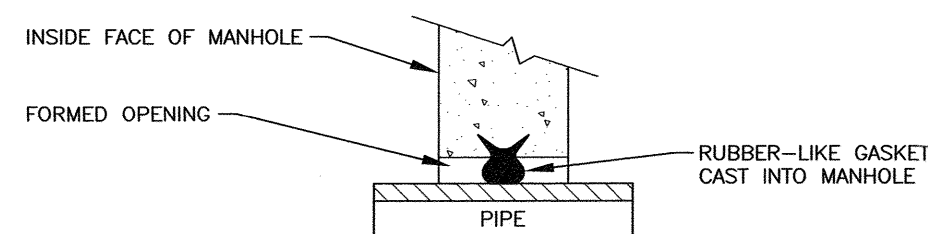

A-LOK
(OR ACCEPTABLE SUBSTITUTE)

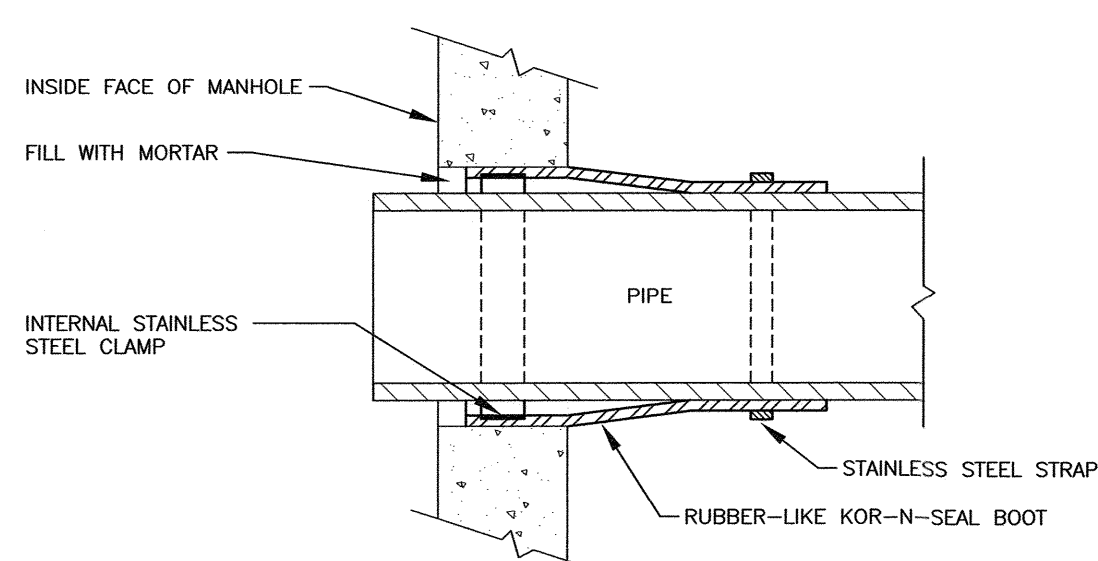

KOR-N-SEAL JOINT SLEEVE
(OR ACCEPTABLE SUBSTITUTE)

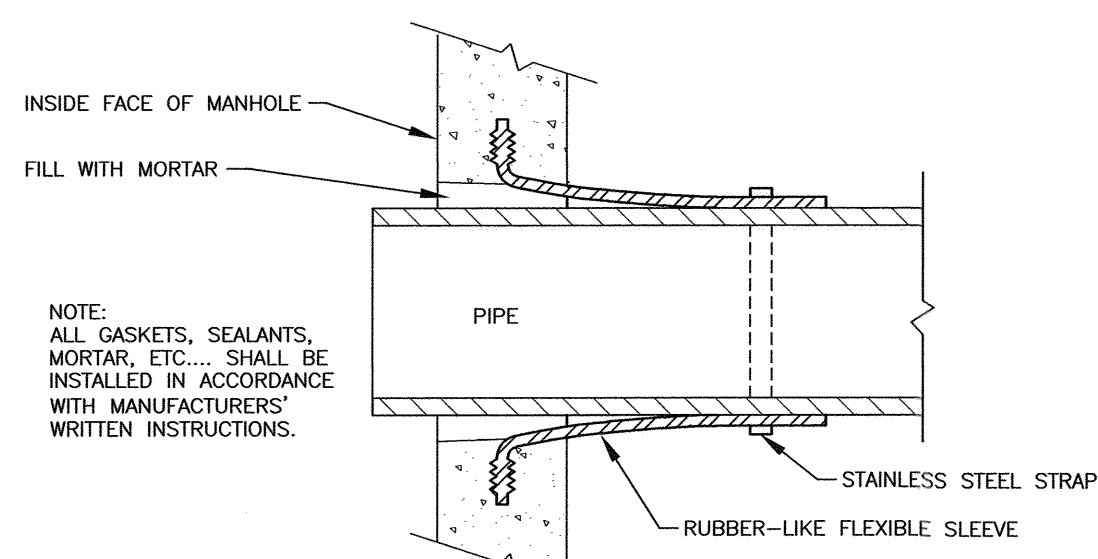

LOCK-JOINT FLEXIBLE MANHOLE SLEEVE
(OR ACCEPTABLE SUBSTITUTE)

DETAIL "A" - PIPE TO MANHOLE JOINTS

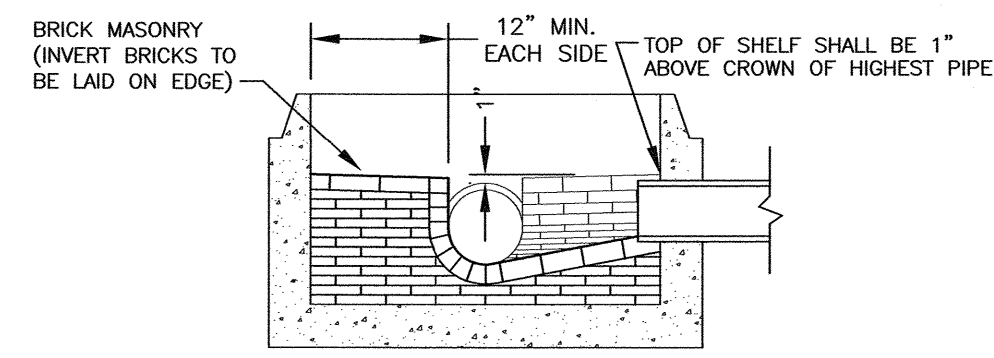

SECTION "B-B"

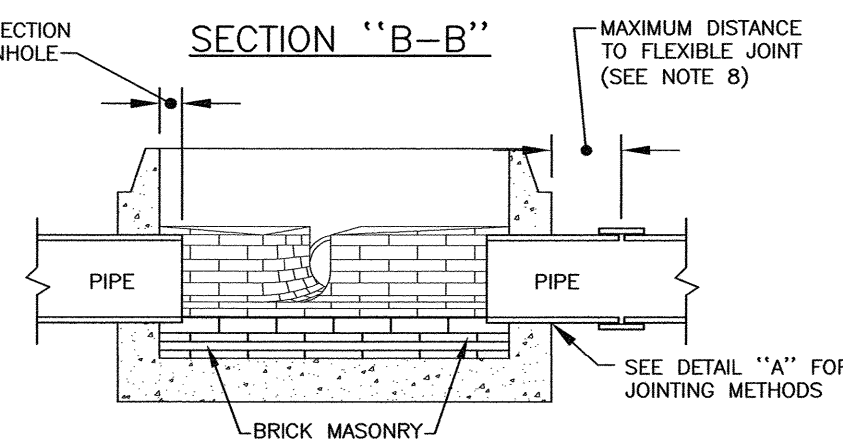

SECTION "A-A"

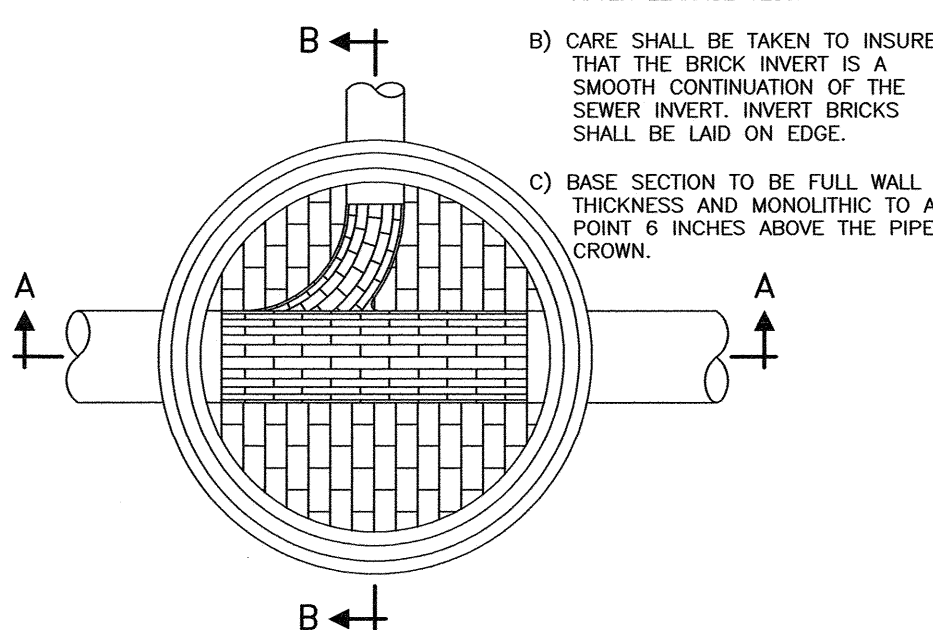

TYPICAL MANHOLE - PLAN VIEW

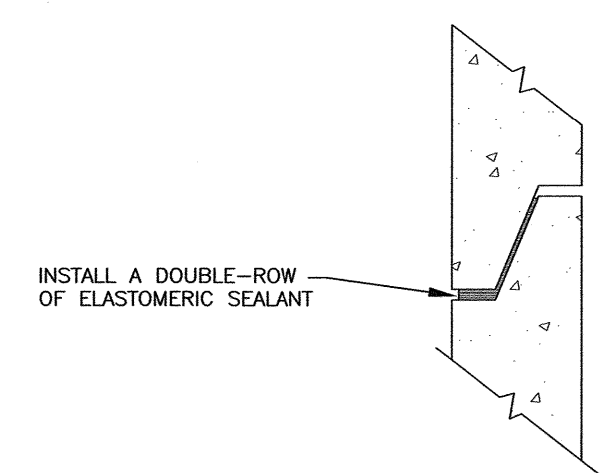

ELASTOMERIC SEALANT

NOTE: ALL GASKETS AND SEALANTS SHALL BE INSTALLED IN ACCORDANCE WITH MANUFACTURERS' WRITTEN INSTRUCTIONS.

DETAIL "B" - HORIZONTAL JOINTS

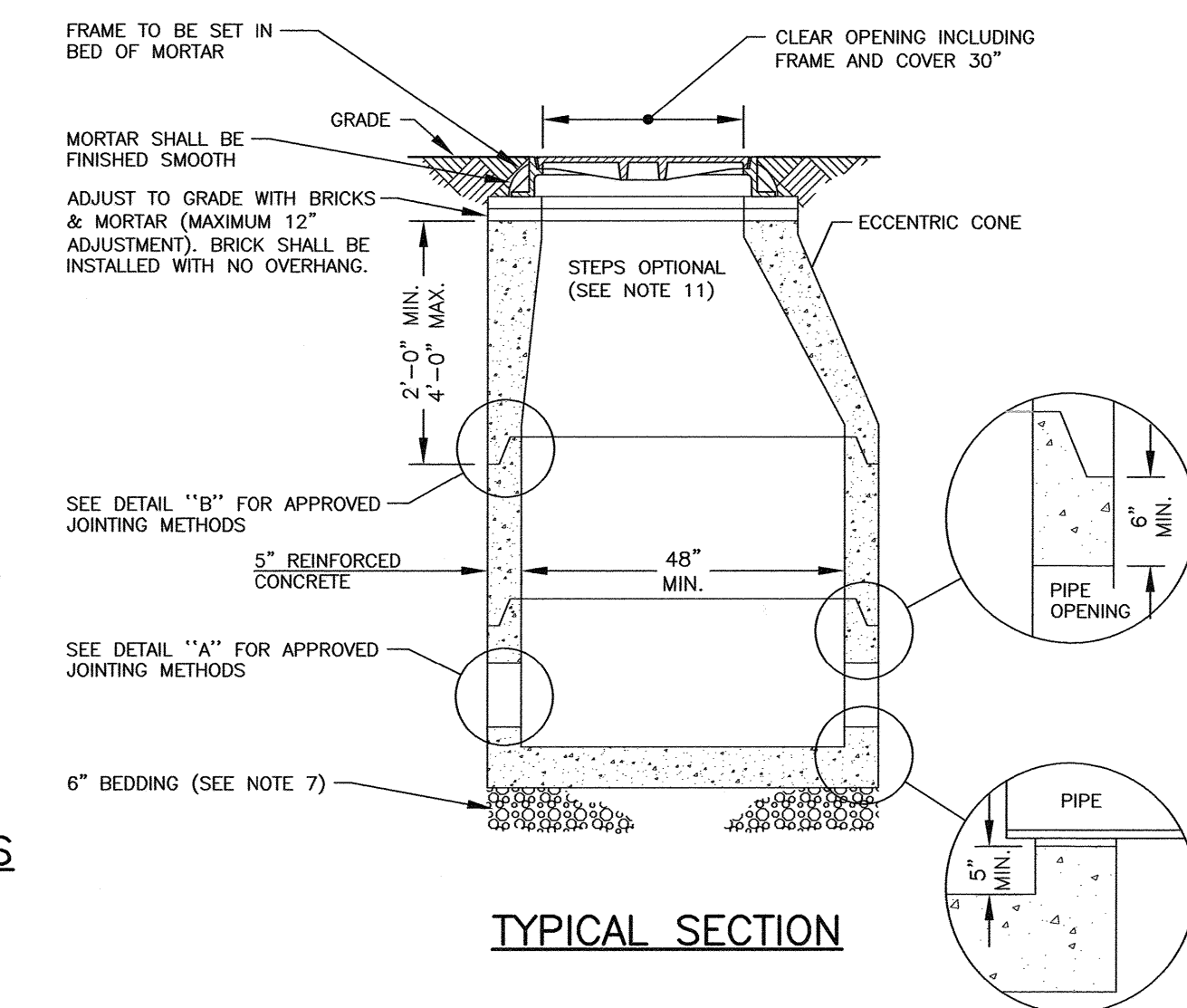

TYPICAL SECTION

APPROVED BY THE PORTSMOUTH PLANNING BOARD

CHAIRMAN _____ DATE _____

SEWER MANHOLE DETAILS

INSTALL PER PORTSMOUTH REQUIREMENTS NTS

SCALE: AS NOTED NOVEMBER 2023

SEWER DETAILS

D5



3 CONGRESS ST., SUITE 1
 PORTSMOUTH NH 03801
 603.986.0042
 www.ARCove.com

**581 Lafayette Road
 Apartments**

581 LAFAYETTE RD
 PORTSMOUTH, NH, 03801

PROJECT NO: 1013

OWNER
 ATLAS COMMONS, LLC
 3 PLEASANT STREET, SUITE 400
 PORTSMOUTH, NH 03801
 603.427.0725

CIVIL ENGINEERING
 AMBIT ENGINEERING, A DIVISION OF
 HALEY WARD
 200 GRIFFIN ROAD, UNIT 3
 PORTSMOUTH, NH 03801
 603.430.9282
<https://www.ambitengineering.com/>

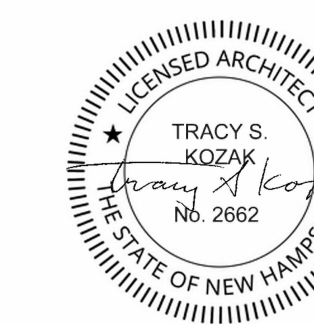

SITE PLAN REVIEW

REVISIONS

NO.	DATE	DESCRIPTION

ROOF PLAN

SCALE: 1/16" = 1'-0"
 DATE: 1/24/2024
 DRAWN: Author
 CHECKED: Checker

PB1.07

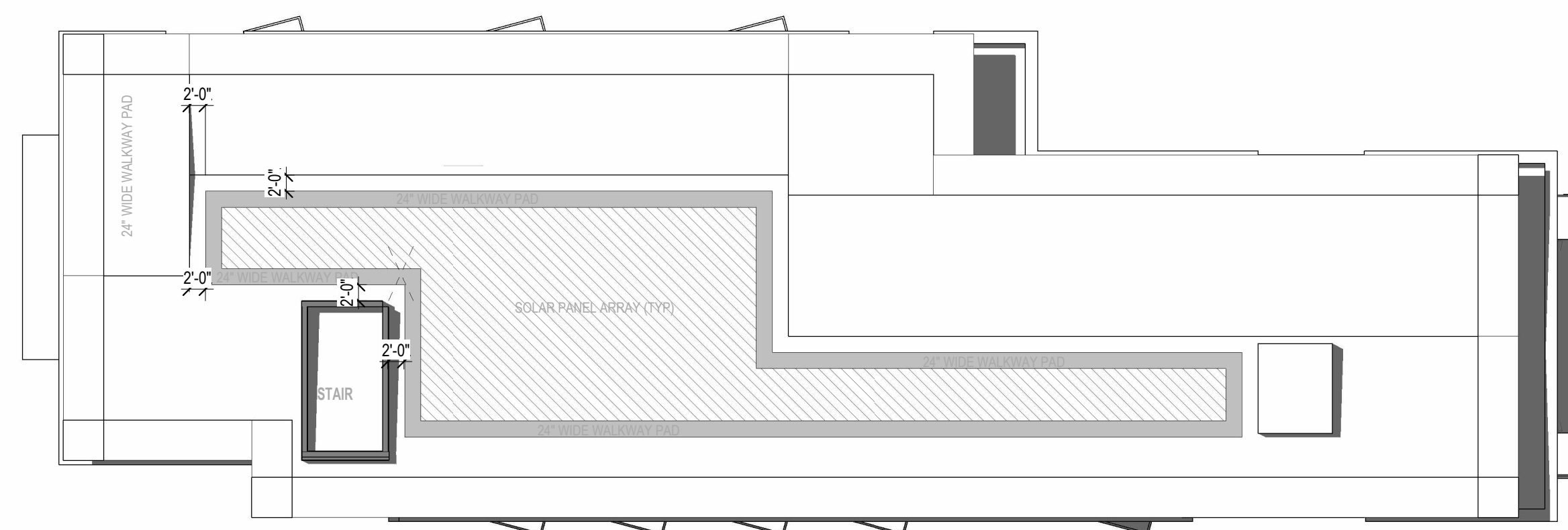
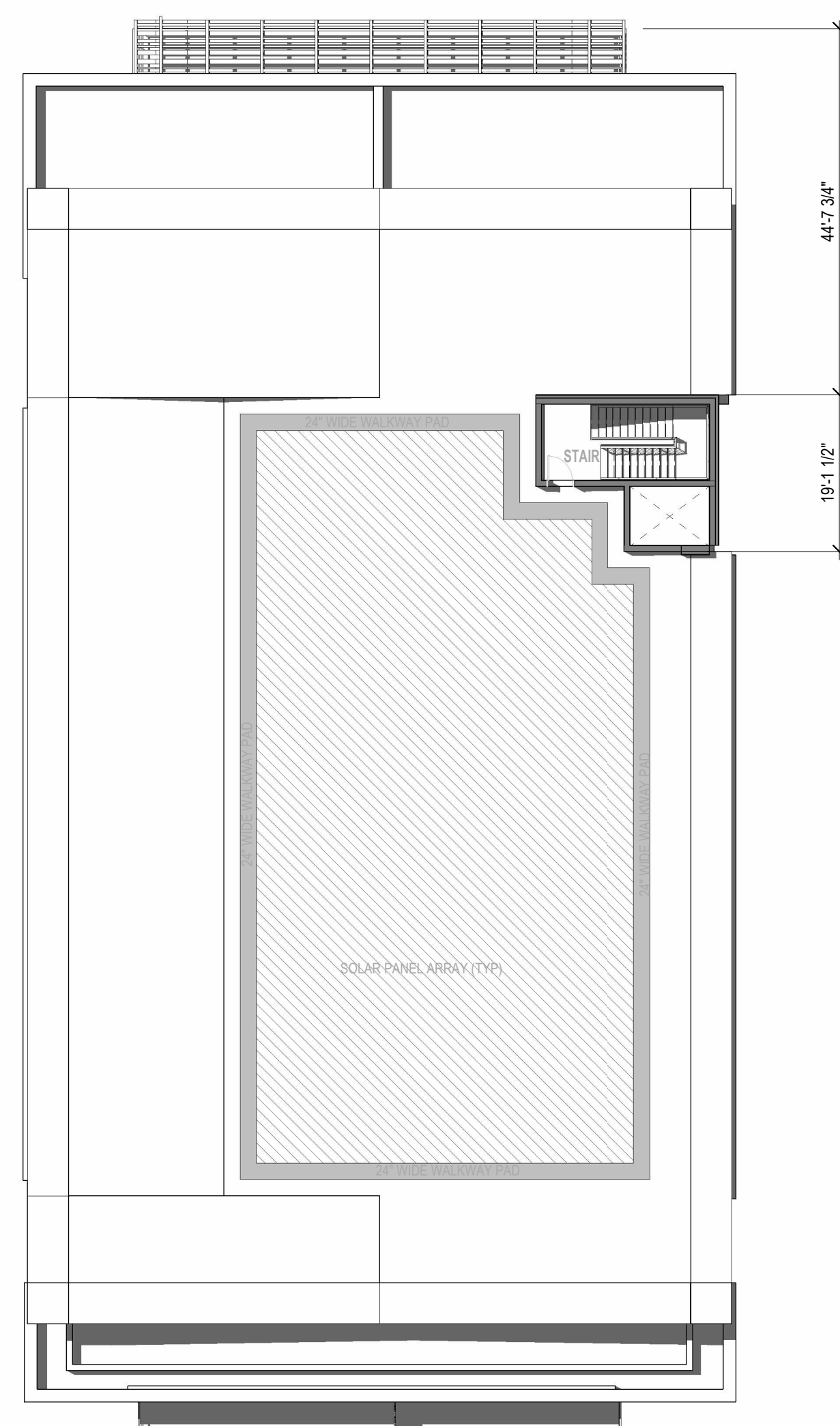



3 CONGRESS ST., SUITE1
 PORTSMOUTH NH 03801
 603.988.0042
 www.ARCOVE.com

581 Lafayette Road Apartments

581 LAFAYETTE RD
 PORTSMOUTH, NH, 03801

PROJECT NO: 1013

OWNER
 ATLAS COMMONS, LLC
 3 PLEASANT STREET, SUITE 400
 PORTSMOUTH, NH 03801
 603.427.0725

CIVIL ENGINEERING
 AMBIT ENGINEERING, A DIVISION OF
 HALEY WARD
 200 GRIFFIN ROAD, UNIT 3
 PORTSMOUTH, NH 03801
 603.430.9282
<https://www.ambitengineering.com/>

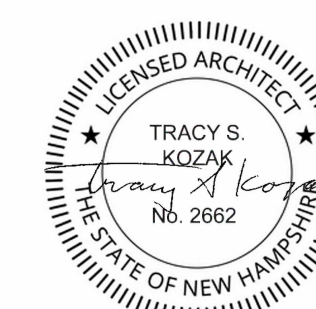

SITE PLAN REVIEW

REVISIONS

NO.	DATE	DESCRIPTION

ELEVATIONS

SCALE: 1/16" = 1'-0"

DATE: 1/24/2024

DRAWN:

CHECKED:

PB1.08

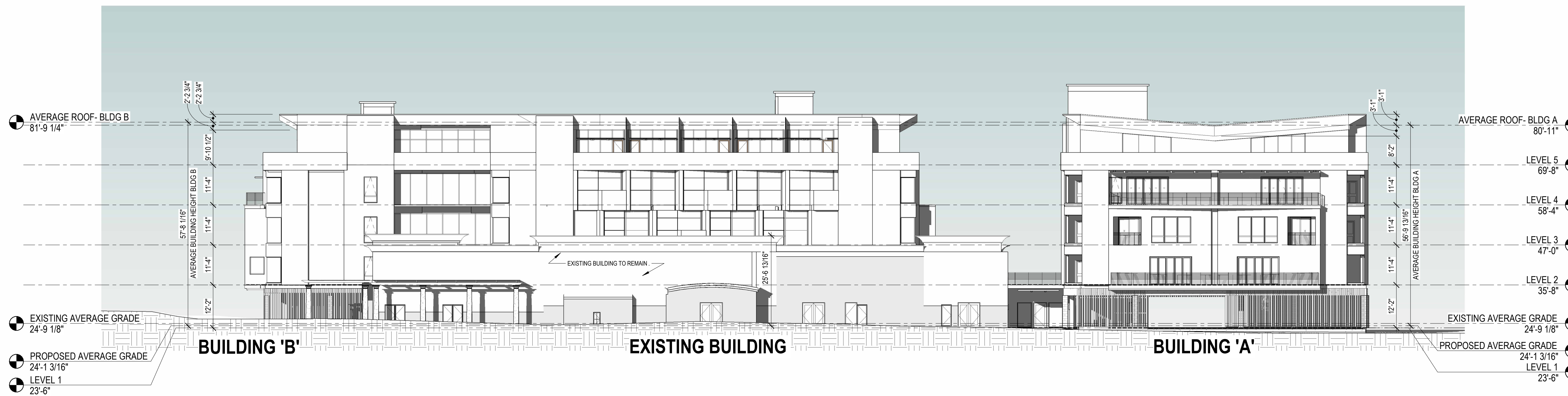

2 WEST ELEVATION PB
 1/16" = 1'-0"

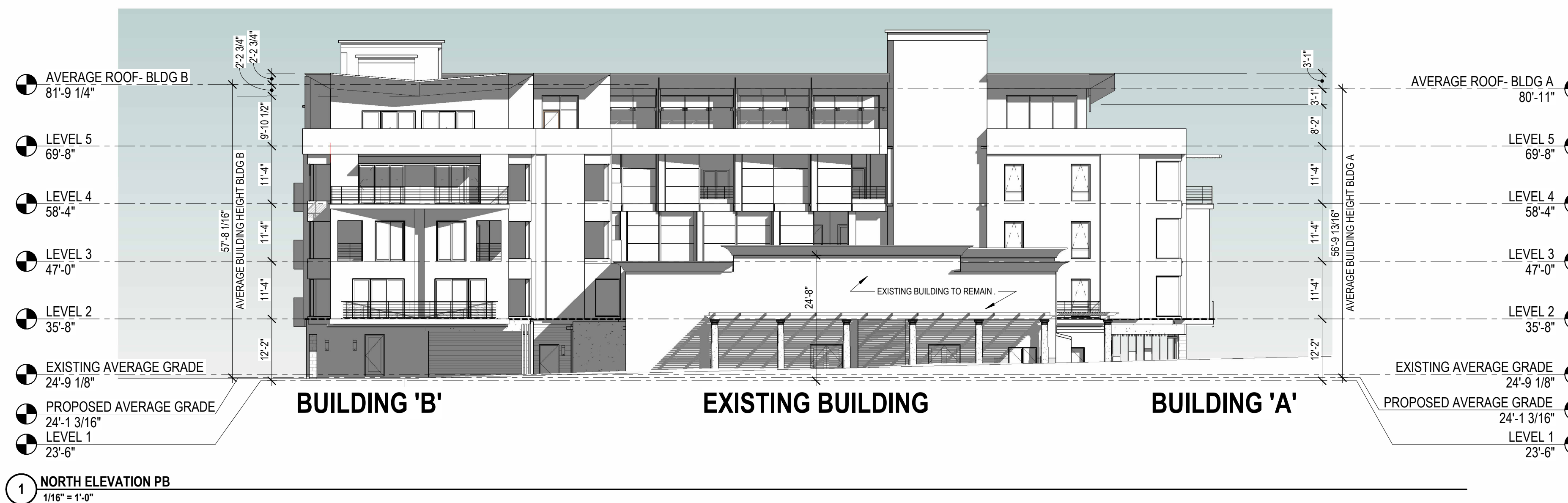

1 NORTH ELEVATION PB
 1/16" = 1'-0"



3 CONGRESS ST., SUITE 1
 PORTSMOUTH NH 03801
 603.988.0042
 www.ARCOVE.com

581 Lafayette Road Apartments

581 LAFAYETTE RD
 PORTSMOUTH, NH, 03801

PROJECT NO: 1013

OWNER
 ATLAS COMMONS, LLC
 3 PLEASANT STREET, SUITE 400
 PORTSMOUTH, NH 03801
 603.427.0725

CIVIL ENGINEERING
 AMBIT ENGINEERING, A DIVISION OF
 HALEY WARD
 200 GRIFFIN ROAD, UNIT 3
 PORTSMOUTH, NH 03801
 603.430.9282
<https://www.ambitengineering.com/>

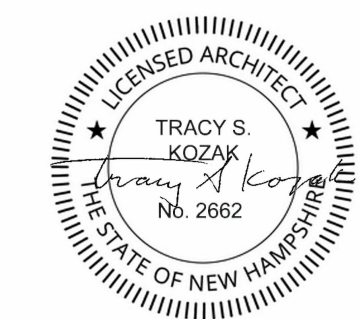

SITE PLAN REVIEW

REVISIONS

NO.	DATE	DESCRIPTION

ELEVATIONS

SCALE: 1/16" = 1'-0"
 DATE: 1/24/2024
 DRAWN: Author
 CHECKED: Checker

PB1.09

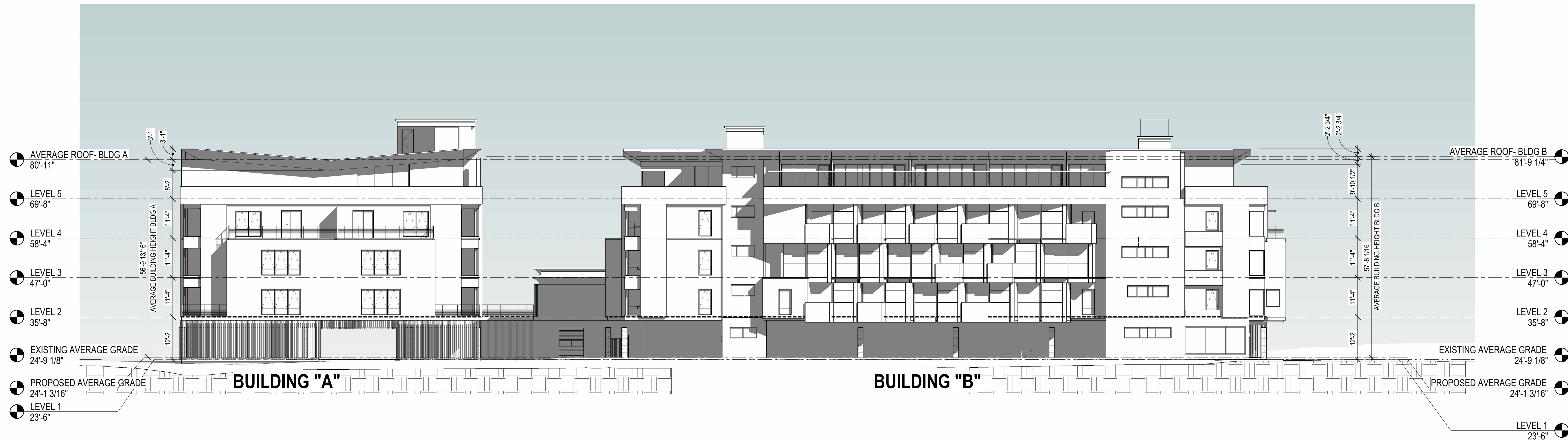

2 EAST ELEVATION PB
 1/16" = 1'-0"

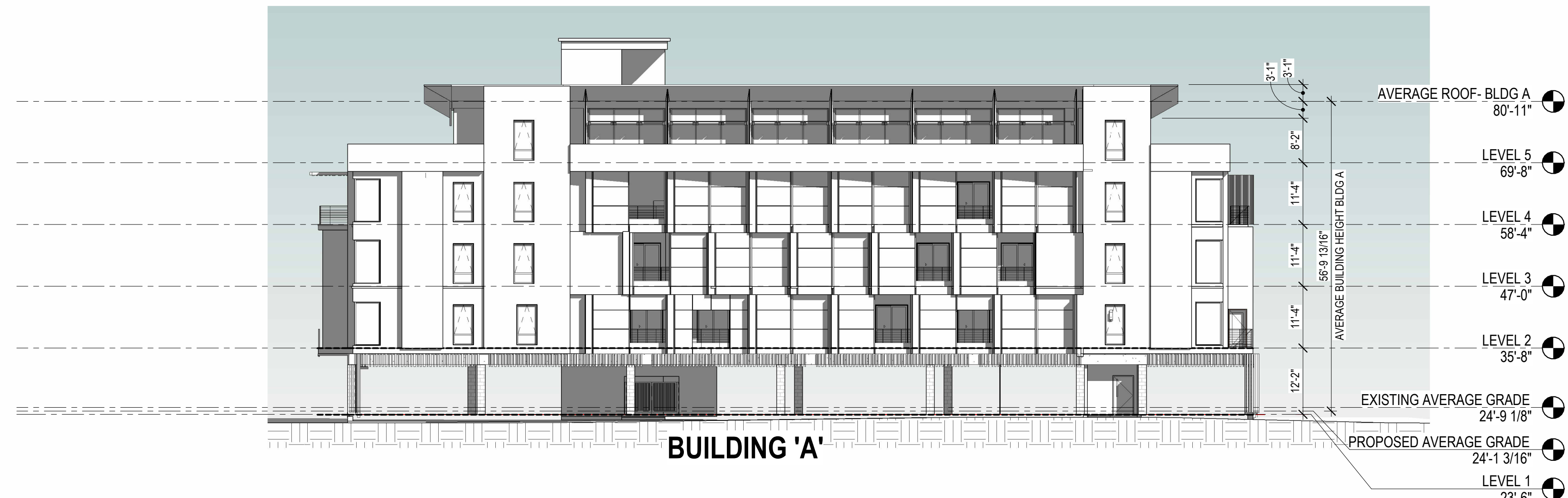

1 SOUTH ELEVATION PB
 1/16" = 1'-0"



3 CONGRESS ST., SUITE1
 PORTSMOUTH NH 03801
 603.988.0042
 www.ARCove.com

581 Lafayette Road Apartments

581 LAFAYETTE RD
 PORTSMOUTH, NH, 03801

PROJECT NO: 1013

OWNER
 ATLAS COMMONS, LLC
 3 PLEASANT STREET, SUITE 400
 PORTSMOUTH, NH 03801
 603.427.0725

CIVIL ENGINEERING
 AMBIT ENGINEERING, A DIVISION OF
 HALEY WARD
 200 GRIFFIN ROAD, UNIT 3
 PORTSMOUTH, NH 03801
 603.430.9282
<https://www.ambitengineering.com/>

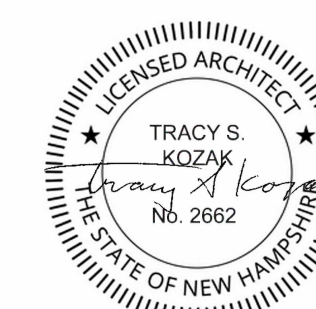

SITE PLAN REVIEW

REVISIONS

NO.	DATE	DESCRIPTION

RENDERING

SCALE: _____
 DATE: 1/24/2024
 DRAWN: Author
 CHECKED: Checker

PB1.10



2 PERSPECTIVE FROM NW - COVER Copy 1



3 PERSPECTIVE FROM SE concept Copy 1



1 PERSPECTIVE FROM SW schematic Copy 1