

**Civil  
Site Planning  
Environmental  
Engineering**

133 Court Street  
Portsmouth, NH  
03801-4413

October 23, 2024

Peter Stith, Planning Manager  
City of Portsmouth Municipal Complex  
1 Junkins Avenue  
Portsmouth, New Hampshire 03801

**Re: Technical Advisory Committee Resubmission  
Assessor's Map 222, Lot 11  
550 Sagamore Avenue  
Altus Project No. 5591**

Dear Peter,

On behalf of Green and Company (Green), Altus Engineering, LLC (Altus), presented an application for a four-lot subdivision at 550 Sagamore Avenue to the Technical Advisory Committee at the October TAC meeting. The Committee requested modest changes to the plans.

In general the revisions include:

- Relocating the rear stormwater management area an additional 20-feet from the rear lot line to retain additional forested area. With the exception of the drainage outfall, approximately 35-feet of natural area will be retained.
- The finish floor for each building has been raised and the basement slab elevation identified to demonstrate that the perimeter drains have positive pitch and do not require sump pumps.
- The house on Lot 3 has been moved further from Sagamore Avenue to improve the grades around the proposed home.
- The proposed utility and drainage easements have been added to the Subdivision Plan.
- The proposed private right-of-way is now identified as Lot 4 and is noted as non-buildable.
- Plantings have been added at the base of the retaining wall adjacent to the small, isolated wetland.
- Representative building plans and elevations are included in the submission package.

Enclosed please find the following for consideration at the November 5<sup>th</sup> TAC meeting:

- Letter of Authorization
- Revised Plan set
- Viewpoint application (previous submission, filed on-line only)
- Application fee check (previous submission, filed on-line only)
- Email with City regarding average speed
- Subdivision Application checklist
- Site Plan Review Application checklist
- Revised Drainage Study
- Stormwater Inspection and Maintenance Manual
- Wetlands Report by Joseph Noel, CWS
- Conceptual Subdivision Demonstration Plan (50-foot ROW and 32-foot-wide roadway)
- Waiver requests
- Building floor plans and elevations
- Landscape Planting Photos

Please feel free to call or email me directly should you have any questions or need any additional information in advance of the meeting.

Sincerely,

**ALTUS ENGINEERING, LLC**



Enclosures

eCopy: Michael Green  
Jenna Green  
Peter Agrodnia, LLS Easterly Surveying

wde/5591.00 10-23-24 cvr ltr.docx

# RESIDENTIAL SUBDIVISION

550 SAGAMORE AVENUE  
Portsmouth, New Hampshire

**Owner:**  
FRANCES E. MOUFLOUZE,  
TED W. ALEX &  
PATRICIA CAMERON, TRUSTEES  
THE FRANCES E. MOUFLOUZE REVOCABLE TRUST  
OF 2015  
104 LOCKE ROAD  
RYE, NH 03870

## TAX MAP 222, Lot 11

ISSUED FOR TAC RECOMMENDATION OF APPROVAL

**Applicant:**  
GREEN & COMPANY  
C/O JENNA GREEN  
11 LAFAYETTE ROAD  
P.O. BOX 1297  
NORTH HAMPTON, NH 03862  
603-501-8455

Plan Issue Date:

TAC Submission            SEPTEMBER 16, 2024  
TAC Resubmission        OCTOBER 23, 2024

**Civil Engineer:**

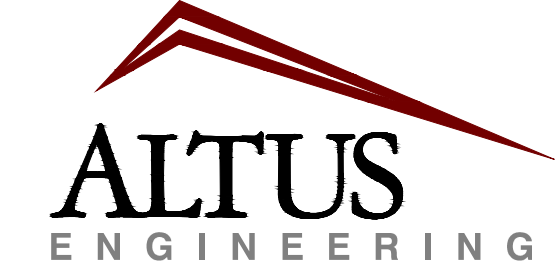

133 Court Street Portsmouth, NH 03801  
(603) 433-2335 www.altus-eng.com

**Surveyor:**  
North  
W EASTERLY  
SURVEYING  
1021 GOODWIN ROAD, UNIT 1  
ELIOT, MAINE 03903  
207-436-6333

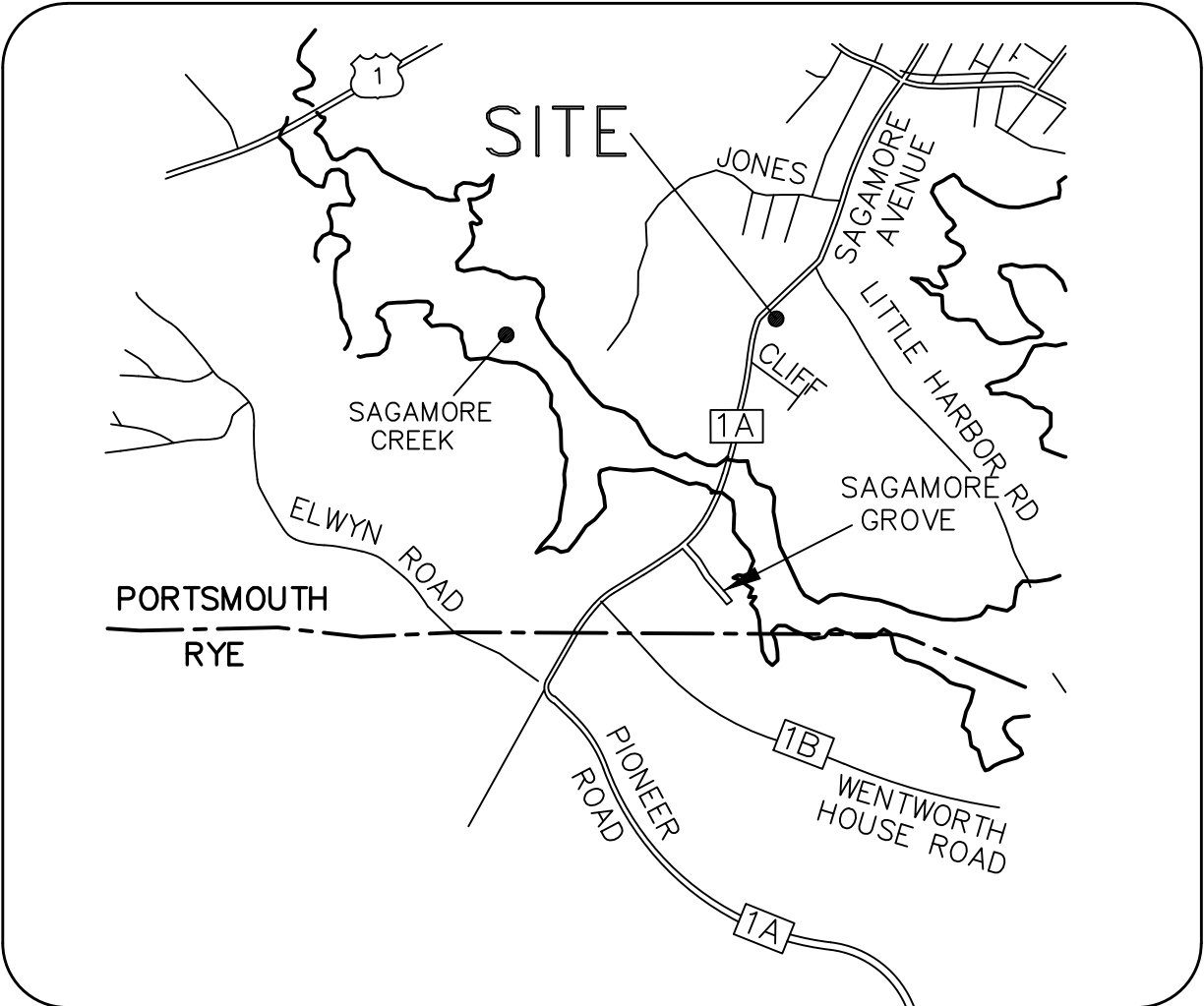

LOCUS NOT TO SCALE

**Wetland/Soil Scientist:**  
Joseph W. Noel, CPSS/CS  
P.O. Box 174  
South Berwick, ME 03908  
207 384-5587

Sheet Index	Sheet No.:	Rev.	Date
Existing Conditions Plan	-	A	08/29/24
Subdivision & Easement Plan (C-1)	1 OF 1	1	10/23/24
Site Plan	C-2	1	10/23/24
Utilities Plan	C-3	1	10/23/24
Roadway Plan & Profile	C-4	1	10/23/24
Grading and Drainage Plan	C-5	1	10/23/24
Sight Distance Plan	C-6	0	09/16/24
Fire Truck Turning Plan	C-7	0	09/16/24
Construction Details	D-1	0	09/16/24
Construction Details	D-2	0	09/16/24
Construction Details	D-3	0	09/16/24
Construction Details	D-4	0	09/16/24
Construction Details	D-5	0	09/16/24
Construction Details	D-6	0	09/16/24
Landscape Plan	L-1	1	10/23/24

Permit Summary	Submitted	Received
Portsmouth Subdivision Approval	09/16/24	-
NHDES Sewer Connection	-	-
EPA Notice of Intent	By Contractor 14 days prior to construction	
Portsmouth Drain Connection Permit	-	-

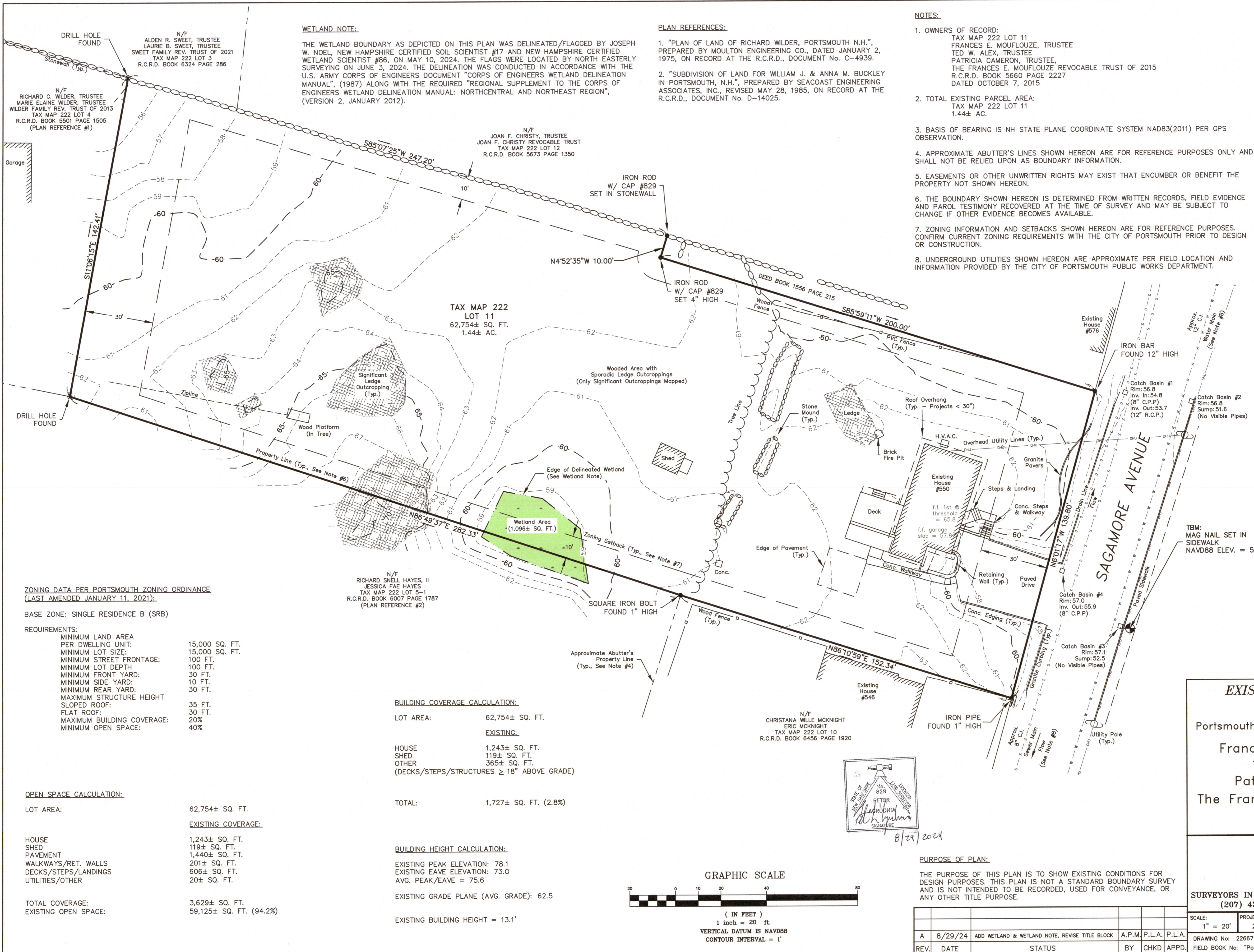

**WETLAND NOTE:**

THE WETLAND BOUNDARY AS DEPICTED ON THIS PLAN WAS DELINEATED/FLAGGED BY JOSEPH W. NOEL, NEW HAMPSHIRE CERTIFIED SOIL SCIENTIST #17 AND NEW HAMPSHIRE CERTIFIED WETLAND SCIENTIST #86, ON MAY 10, 2024. THE FLAGS WERE LOCATED BY NORTH EASTERLY SURVEYING ON JUNE 3, 2024. THE DELINEATION WAS CONDUCTED IN ACCORDANCE WITH THE U.S. ARMY CORPS OF ENGINEERS DOCUMENT "CORPS OF ENGINEERS WETLAND DELINEATION MANUAL", (1987) ALONG WITH THE REQUIRED "REGIONAL SUPPLEMENT TO THE CORPS OF ENGINEERS WETLAND DELINEATION MANUAL: NORTHCENTRAL AND NORTHEAST REGION", (VERSION 2, JANUARY 2012).

**PLAN REFERENCES:**

- "PLAN OF LAND OF RICHARD WILDER, PORTSMOUTH N.H.", PREPARED BY MOULTON ENGINEERING CO., DATED JANUARY 2, 1975, ON RECORD AT THE R.C.R.D., DOCUMENT No. C-4939.
- "SUBDIVISION OF LAND FOR WILLIAM J. & ANNA M. BUCKLEY IN PORTSMOUTH, N.H.", PREPARED BY SEACOAST ENGINEERING ASSOCIATES, INC., REVISED MAY 28, 1985, ON RECORD AT THE R.C.R.D., DOCUMENT No. D-14025.

**NOTES:**

- OWNERS OF RECORD:  
TAX MAP 222 LOT 11  
FRANCES E. MOUFLOUZE, TRUSTEE  
TED W. ALEX, TRUSTEE  
PATRICIA CAMERON, TRUSTEE  
THE FRANCES E. MOUFLOUZE REVOCABLE TRUST OF 2015  
R.C.R.D. BOOK 5660 PAGE 2227  
DATED OCTOBER 7, 2015
- TOTAL EXISTING PARCEL AREA:  
TAX MAP 222 LOT 11  
1.44± AC.
- BASIS OF BEARING IS NH STATE PLANE COORDINATE SYSTEM NAD83(2011) PER GPS OBSERVATION.
- APPROXIMATE ABUTTER'S LINES SHOWN HEREON ARE FOR REFERENCE PURPOSES ONLY AND SHALL NOT BE RELIED UPON AS BOUNDARY INFORMATION.
- EASEMENTS OR OTHER UNWRITTEN RIGHTS MAY EXIST THAT ENCUMBER OR BENEFIT THE PROPERTY NOT SHOWN HEREON.
- THE BOUNDARY SHOWN HEREON IS DETERMINED FROM WRITTEN RECORDS, FIELD EVIDENCE AND PAROL TESTIMONY RECOVERED AT THE TIME OF SURVEY AND MAY BE SUBJECT TO CHANGE IF OTHER EVIDENCE BECOMES AVAILABLE.
- ZONING INFORMATION AND SETBACKS SHOWN HEREON ARE FOR REFERENCE PURPOSES. CONFIRM CURRENT ZONING REQUIREMENTS WITH THE CITY OF PORTSMOUTH PRIOR TO DESIGN OR CONSTRUCTION.
- UNDERGROUND UTILITIES SHOWN HEREON ARE APPROXIMATE PER FIELD LOCATION AND INFORMATION PROVIDED BY THE CITY OF PORTSMOUTH PUBLIC WORKS DEPARTMENT.

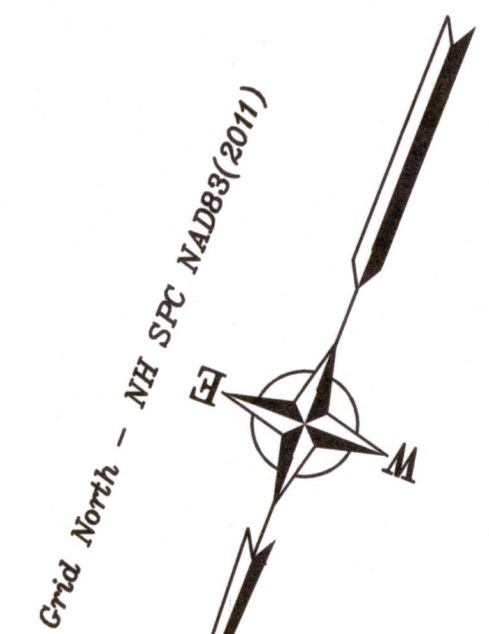
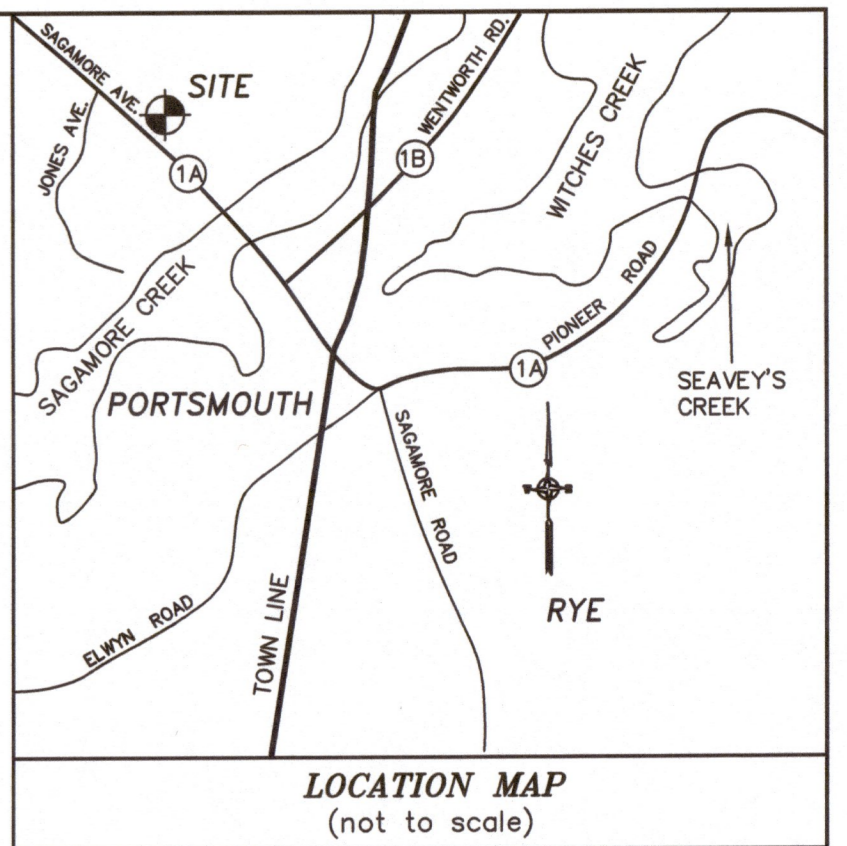

**ZONING DATA PER PORTSMOUTH ZONING ORDINANCE (LAST AMENDED JANUARY 11, 2021):**

BASE ZONE: SINGLE RESIDENCE B (SRB)

**REQUIREMENTS:**

MINIMUM LAND AREA PER DWELLING UNIT:	15,000 SQ. FT.
MINIMUM LOT SIZE:	15,000 SQ. FT.
MINIMUM STREET FRONTAGE:	100 FT.
MINIMUM LOT DEPTH:	100 FT.
MINIMUM FRONT YARD:	30 FT.
MINIMUM SIDE YARD:	10 FT.
MINIMUM REAR YARD:	30 FT.
MAXIMUM STRUCTURE HEIGHT SLOPED ROOF:	35 FT.
FLAT ROOF:	30 FT.
MAXIMUM BUILDING COVERAGE:	20%
MINIMUM OPEN SPACE:	40%

**OPEN SPACE CALCULATION:**

LOT AREA:	62,754± SQ. FT.
<b>EXISTING COVERAGE:</b>	
HOUSE	1,243± SQ. FT.
SHED	119± SQ. FT.
PAVEMENT	1,440± SQ. FT.
WALKWAYS/RET. WALLS	201± SQ. FT.
DECKS/STEPS/LANDINGS	606± SQ. FT.
UTILITIES/OTHER	20± SQ. FT.
TOTAL COVERAGE:	3,629± SQ. FT.
EXISTING OPEN SPACE:	59,125± SQ. FT. (94.2%)

**BUILDING COVERAGE CALCULATION:**

LOT AREA:	62,754± SQ. FT.
<b>EXISTING:</b>	
HOUSE	1,243± SQ. FT.
SHED	119± SQ. FT.
OTHER	365± SQ. FT.
(DECKS/STEPS/STRUCTURES ≥ 18" ABOVE GRADE)	
TOTAL:	1,727± SQ. FT. (2.8%)

**BUILDING HEIGHT CALCULATION:**

EXISTING PEAK ELEVATION:	78.1
EXISTING LEAVE ELEVATION:	73.0
AVG. PEAK/EAVE =	75.6
EXISTING GRADE PLANE (AVG. GRADE):	62.5
EXISTING BUILDING HEIGHT =	13.1'

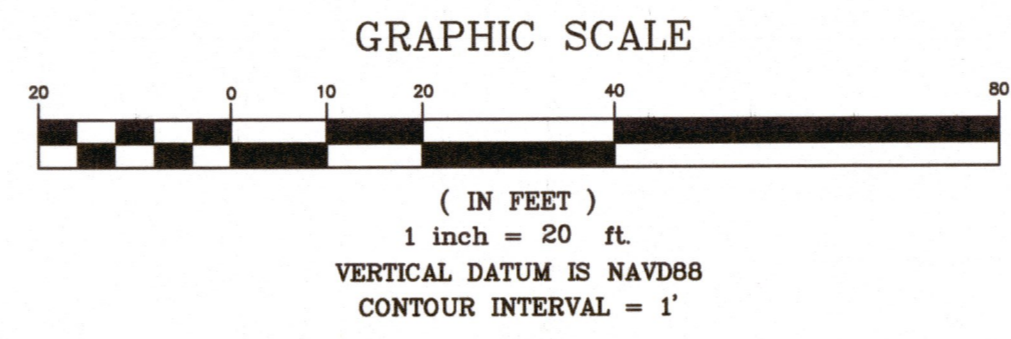

**EXISTING CONDITIONS PLAN**  
FOR PROPERTY AT  
550 Sagamore Avenue  
Portsmouth, Rockingham Co., New Hampshire  
OWNED BY  
Frances E. Mouflouze, Trustee  
Ted W. Alex, Trustee  
Patricia Cameron, Trustee  
The Frances E. Mouflouze Revocable Trust of 2015  
c/o Ted W. Alex  
104 Locke Road, Rye, NH 03870

SCALE: 1" = 20'		PROJECT NO. 22667	DATE: 1/9/2023	SHEET: 1 OF 1	DRAWN BY: A.P.M./J.D.S.	CHECKED BY: P.L.A.
		DRAWING No: 22667 PROP SURVEY NHSPC FIELD BOOK No: "Portsmouth #18"				
<b>North</b> W  EASTERLY SURVEYING SURVEYORS IN N.H. & MAINE 1021 GOODWIN ROAD, UNIT #1 ELIOT, MAINE 03903						
<b>Tax Map 222 Lot 11</b>						

**PURPOSE OF PLAN:**

THE PURPOSE OF THIS PLAN IS TO SHOW EXISTING CONDITIONS FOR DESIGN PURPOSES. THIS PLAN IS NOT A STANDARD BOUNDARY SURVEY AND IS NOT INTENDED TO BE RECORDED, USED FOR CONVEYANCE, OR ANY OTHER TITLE PURPOSE.

REV.	DATE	STATUS	BY	CHKD	APPD.
A	8/29/24	ADD WETLAND & WETLAND NOTE, REVISE TITLE BLOCK	A.P.M.	P.L.A.	P.L.A.

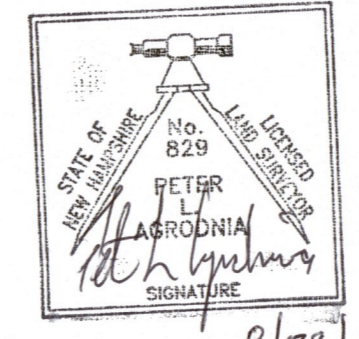



SAGAMORE AVENUE

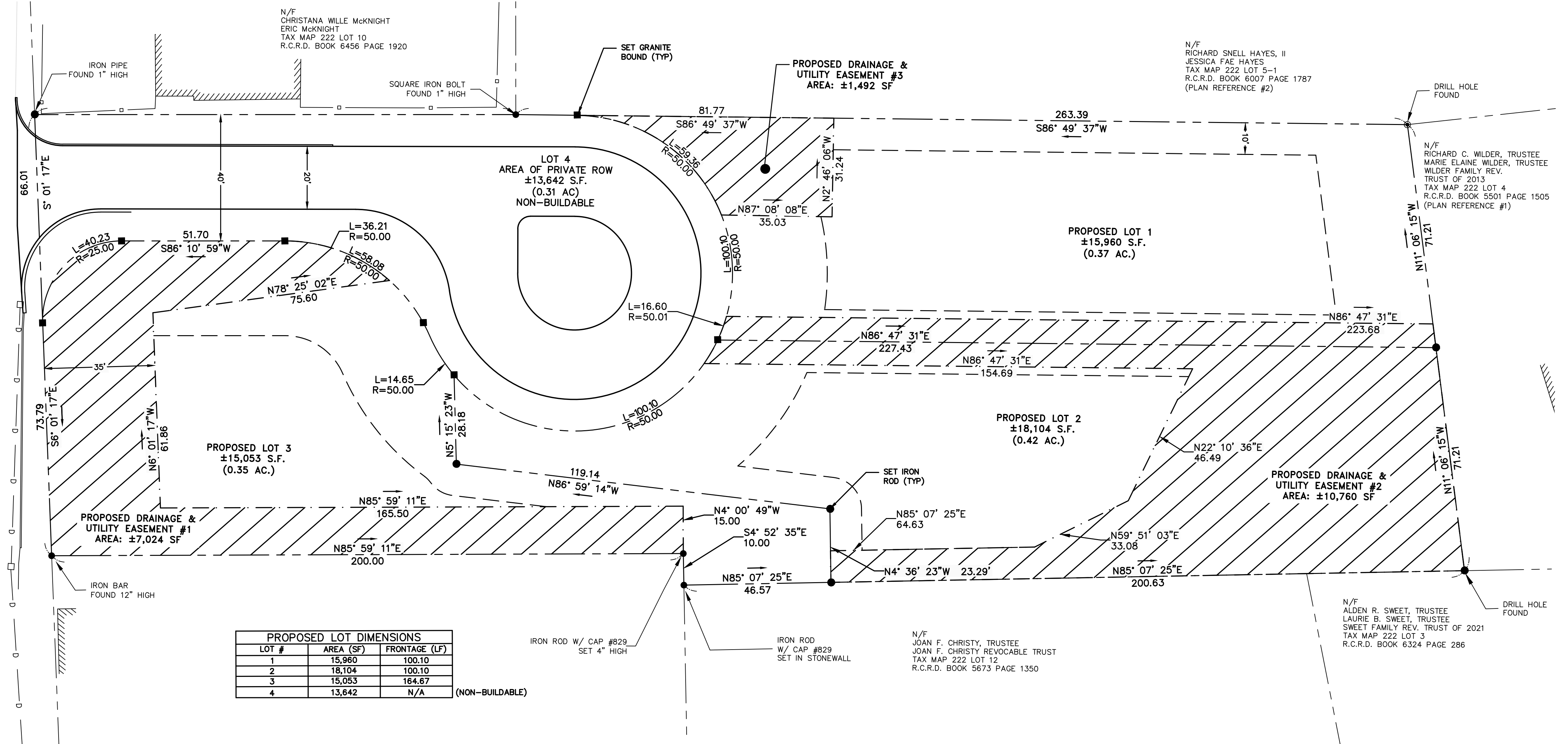

LOT #	AREA (SF)	FRONTAGE (LF)
1	15,960	100.10
2	18,104	100.10
3	15,053	164.67
4	13,642	N/A

(NON-BUILDABLE)

**SUBDIVISION NOTES**

- DESIGN INTENT - THIS PLAN IS INTENDED TO DEPICT A SINGLE-FAMILY RESIDENTIAL SUBDIVISION ON A PRIVATE ROAD.
- THE BASE PLAN USED HERE WAS DEVELOPED FROM NORTH EASTERLY SURVEY
- ZONE: SRB (SINGLE RESIDENCE B)
- DIMENSIONAL REQUIREMENTS:**
  - LOT AREA: 15,000 S.F.
  - FRONTAGE: 100'
  - LOT DEPTH: 100'
  - FRONT YARD: 30'
  - SIDE YARD: 10'
  - REAR YARD: 30'
  - BUILDING HEIGHT: 35' (MAX. w/SLOPED ROOF)
  - BUILDING COVERAGE: 20% MAX.
  - OPEN SPACE: 40% MIN.
  - WETLAND BUFFER: NONE (WETLAND LESS THAN 10,000 S.F.)
- PARKING REQUIREMENTS: NR (NO REQUIREMENT)
- PARCEL IS NOT IN A FLOOD HAZARD ZONE AE PER FLOOD INSURANCE RATE MAP (FIRM), ROCKINGHAM COUNTY, NEW HAMPSHIRE, DATED JANUARY 29, 2021.
- WETLANDS WERE DELINEATED BY JOSEPH NOEL, NH CERTIFIED WETLANDS SCIENTIST #086, ON MAY 10, 2024.
- WAIVERS REQUIRED:
  - SUBDIVISION REGULATION "RESIDENTIAL STREET MINIMUM STANDARDS" DIAGRAM TO ALLOW 20' WIDTH WHERE 32' IS REQUIRED.
  - SECTION VI 3. B. STREET RIGHT-OF-WAYS FOR RESIDENTIAL STREETS, STREETS SHALL BE 50 FEET, 40 FEET IS PROVIDED.
  - SECTION VI 1 CUL-DE-SACS. MINIMUM CURB RADIUS OF 50 FEET SHALL BE PROVIDED, 40 FEET IS PROPOSED.
- AREA OF DISTURBANCE GREATER THAN 43,560 S.F., COVERAGE UNDER EPA NPDES PHASE II CONSTRUCTION GENERAL PERMIT REQUIRED, CONTRACTOR SHALL PREPARE SWPPP AND FILE NOI AT LEAST TWO WEEKS BEFORE BEGINNING EARTHWORK.
- A HOMEOWNER'S ASSOCIATION (HOA) SHALL BE REQUIRED FOR THE PERPETUAL MAINTENANCE OF PRIVATE ROADWAY, UTILITY AND STORMWATER INFRASTRUCTURE.

- THE "STORMWATER INSPECTION AND MAINTENANCE MANUAL" PREPARED DURING PERMITTING SHALL BE A COMPONENT OF THE HOA DOCUMENTS FOR EACH LOT.
- THE ROADWAY PARCEL SHALL BE SUBJECT TO A BLANKET EASEMENT FOR THE BENEFIT OF THE CITY OF PORTSMOUTH FOR THE PURPOSE OF WATER VALVE AND HYDRANT ACCESS AND WATER SYSTEM LEAK DETECTION.
- THE THREE RESIDENTIAL LOTS IN THE SUBDIVISION SHALL EACH OWN AN EQUAL UNDIVIDED INTEREST IN THE ROADWAY PARCEL. NO RESIDENTIAL USES SHALL BE PERMITTED ON THE ROADWAY PARCEL WHICH SHALL BE RESERVED EXCLUSIVELY FOR A ROADWAY AND ASSOCIATED INFRASTRUCTURE.
- THE ROADWAY PARCEL SHALL BE SUBJECT TO A BLANKET ACCESS, UTILITY AND DRAINAGE EASEMENT FOR THE BENEFIT OF THE HOA AND ALL LOTS THAT ARE PARTY TO IT.
- SEE THE ENTIRE SET OF PLANS RELATED TO THIS SUBDIVISION ON FILE WITH THE CITY OF PORTSMOUTH PLANNING DEPARTMENT.
- THE HOA SHALL ENFORCE NO PARKING ON THE PRIVATE ROADWAY TO MAINTAIN EMERGENCY VEHICLE ACCESS.
- LAND OWNERS AND HOA IS RESPONSIBLE FOR COMPLYING WITH ALL APPLICABLE CODES AND REGULATIONS IN PERPETUITY.
- SNOW SHALL BE STORED AT THE EDGE OF THE ROAD OR REMOVED OFF SITE TO AN APPROVED LOCATION IF REQUIRED TO MAINTAIN SAFE ACCESS. SNOW SHOULD NOT BE DUMPED IN THE WETLANDS.
- THIS PLAN SHALL BE RECORDED AT THE ROCKINGHAM COUNTY REGISTRY OF DEEDS.
- ALL CONDITIONS ON THIS PLAN SET SHOULD REMAIN IN EFFECT IN PERPETUITY.
- THE OWNER OF EACH PARCEL SHALL STORE THEIR TRASH INTERNALLY AND HAVE A PRIVATE HAULER REMOVE IT.
- SEE THE ENTIRE APPROVED SET OF PLANS ASSOCIATED WITH THE PROJECT ON FILE AT THE CITY OF PORTSMOUTH PLANNING DEPARTMENT.

**PLAN REFERENCE:**

- "EXISTING CONDITIONS PLAN FOR PROPERTY AT 550 SAGAMORE AVENUE, PORTSMOUTH, NEW HAMPSHIRE", DATED 06/03/24, BY NORTH EASTERLY SURVEYING, INC.

**LEGEND**

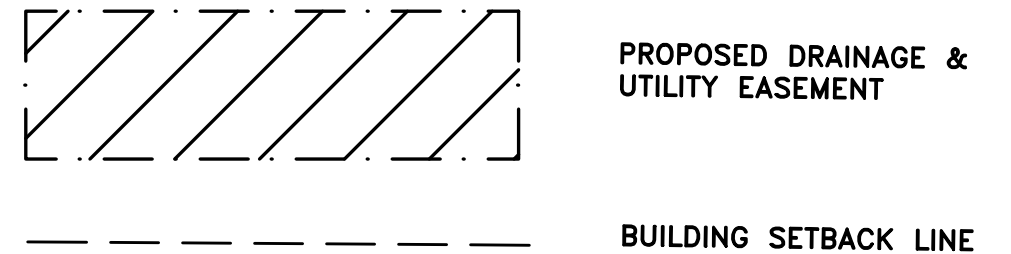

**PURPOSE OF PLAN:**

THE PURPOSE OF THIS PLAN IS TO SHOW THE BOUNDARIES OF THE NEW LOTS ALONG WITH METES & BOUNDS AND THE PROPOSED DRAINAGE & UTILITY EASEMENTS FOR THE PROPOSED DEVELOPMENT. THESE EASEMENTS WILL RUN WITH THE NEW LOTS IN PERPETUITY.

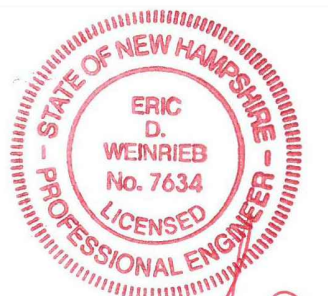

*W. Weiried*  
10/20/24

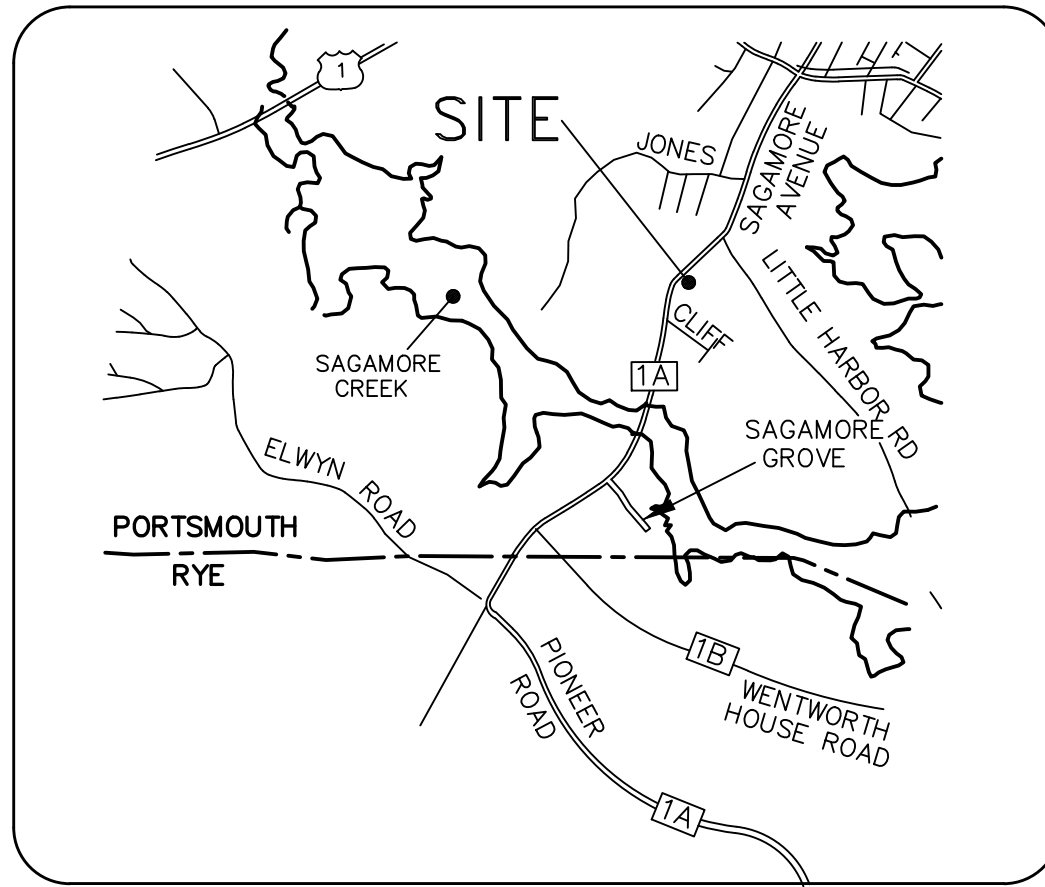

LOCUS NOT TO SCALE

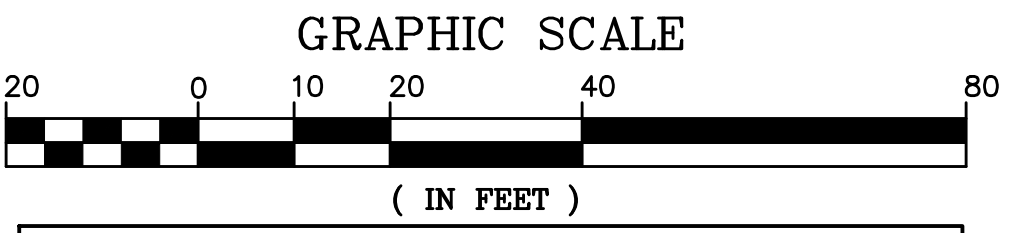

APPROVED BY THE PORTSMOUTH PLANNING BOARD

CHAIRMAN	DATE
----------	------

**ENGINEER:**

133 Court Street Portsmouth, NH 03801  
(603) 433-2335 www.altus-eng.com

**SURVEYOR:**

North  
W EASTERLY SURVEYING

1021 GOODWIN ROAD, UNIT 1  
ELIOT, MAINE 03903  
(207) 439-6333

NOT FOR CONSTRUCTION  
ISSUED FOR: TAC APPLICATION  
ISSUE DATE: OCTOBER 23, 2024

**REVISIONS**

NO.	DESCRIPTION	BY	DATE
0	INITIAL SUBMISSION	EDW	09/16/24
1	PER TAC COMMENTS	EDW	10/23/24

DRAWN BY: JMG  
APPROVED BY: EDW  
DRAWING FILE: 5591C0-1.dwg

**SCALE:**  
22" x 34" - 1" = 20'  
11" x 17" - 1" = 40'

**OWNER:**

FRANCES E. MOUFLOUZE,  
TED W. ALEX &  
PATRICIA CAMERON, TRUSTEES

THE FRANCES E. MOUFLOUZE  
REVOCABLE TRUST OF 2015  
104 LOCKE RD  
RYE, NH 03870

**APPLICANT:**

GREEN & COMPANY  
11 LAFAYETTE ROAD  
P.O. BOX 1297  
NORTH HAMPTON, NH 03862

**PROJECT:**

RESIDENTIAL  
DEVELOPMENT

TAX MAP 222 LOT 11  
550 SAGAMORE AVENUE  
PORTSMOUTH, NH

**TITLE:**

SUBDIVISION  
& EASEMENT  
PLAN (C-1)

**SHEET NUMBER:**

1 OF 1

P5591



SAGAMORE AVENUE

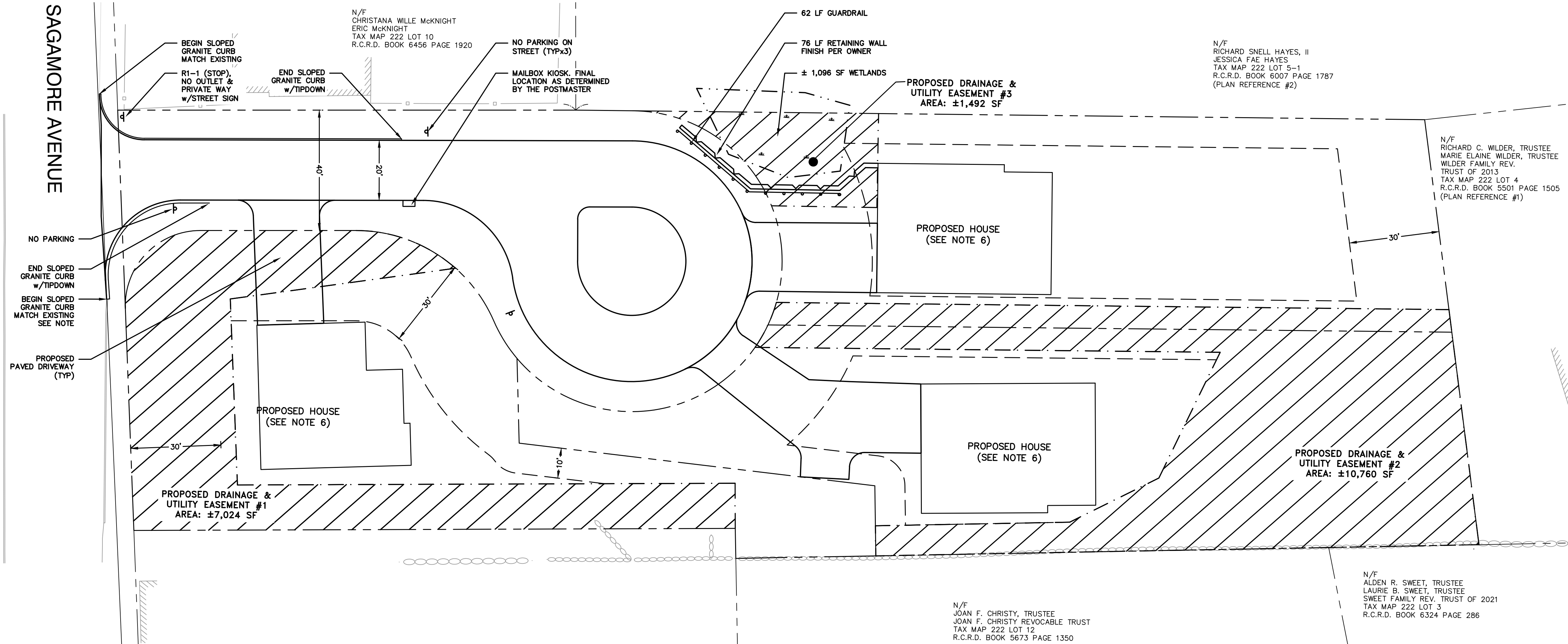

SITE NOTES

- 1. DESIGN INTENT - THIS PLAN IS INTENDED TO DEPICT A SITE PLAN FOR 3 LOT RESIDENTIAL SUBDIVISION SERVICED WITH MUNICIPAL SEWER & WATER FROM A PRIVATE RIGHT-OF-WAY.
2. APPROXIMATE LOT AREA: 1.44 AC.±
3. ZONE: SINGLE RESIDENCE-RESIDENCE B (SRB)
4. DIMENSIONAL REQUIREMENTS: Table with columns for MIN. LOT AREA, MIN. LAND AREA PER DWELLING UNIT, MIN. STREET FRONTAGE, MIN. LOT DEPTH, FRONT SETBACK, SIDE SETBACK, REAR SETBACK, MIN. BUILDING HEIGHT, MIN. BLDG. COVERAGE, MIN. OPEN SPACE.
5. THE WETLAND BOUNDARY AS DEPICTED ON THIS PLAN WAS DELINEATED/FLAGGED BY JOSEPH W. NOEL, NEW HAMPSHIRE CERTIFIED SOIL SCIENTIST#17 AND NEW HAMPSHIRE WETLAND SCIENTIST#86, ON MAY 10, 2024.
6. HOUSE AND DRIVEWAYS SHOWN ON THIS PLAN ARE FOR ILLUSTRATIVE PURPOSES ONLY.
7. EXISTING CURB LINE ON SAGAMORE AVENUE HAS BEEN RECONSTRUCTED BY THE CITY.
8. HOUSES AND DRIVEWAYS SHOWN ON THIS PLAN ARE FOR ILLUSTRATIVE PURPOSES ONLY.
9. IF IMPERVIOUS ON LOT EXCEEDS THE AREA BELOW, AND INDIVIDUAL STORMWATER MANAGEMENT PLAN FOR THE LOT WILL BE REQUIRED LOT 1 3,500 SF, LOT 2 4,300 SF, LOT 3 3,100 SF.

PLAN REFERENCE: 1. "EXISTING CONDITIONS PLAN FOR PROPERTY AT 550 SAGAMORE AVENUE, PORTSMOUTH, NEW HAMPSHIRE", DATED 06/03/24, BY NORTH EASTERLY SURVEYING, INC.

LEGEND

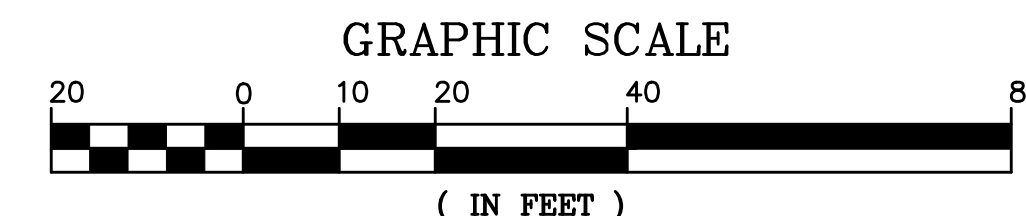
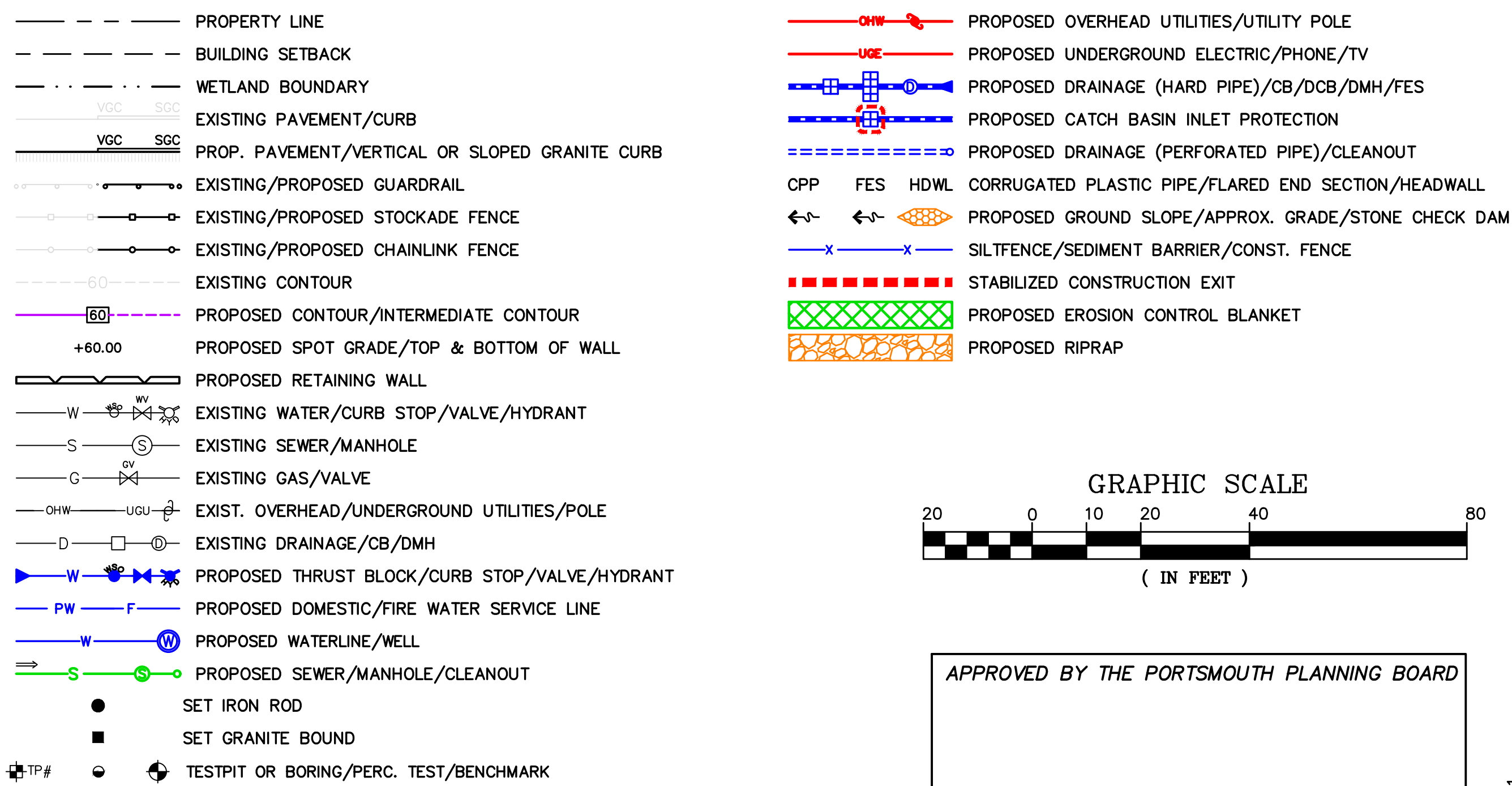

APPROVED BY THE PORTSMOUTH PLANNING BOARD
CHAIRMAN DATE

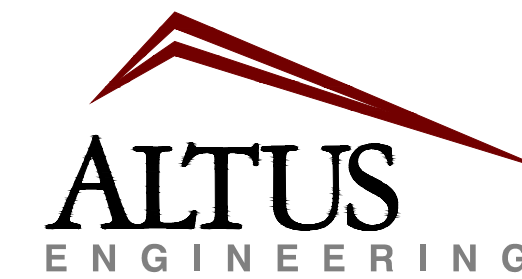

133 Court Street Portsmouth, NH 03801 (603) 433-2335 www.altus-eng.com

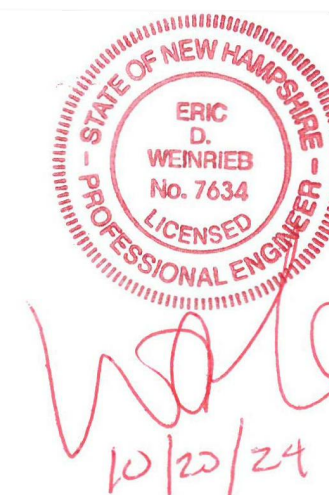

NOT FOR CONSTRUCTION

ISSUED FOR: TAC APPLICATION

ISSUE DATE: OCTOBER 23, 2024

Table with columns: REVISIONS, NO., DESCRIPTION, BY, DATE. Includes entries for initial submission and TAC comments.

DRAWN BY: JMC
APPROVED BY: EDW
DRAWING FILE: 5591C0-1.dwg

SCALE: 22" x 34" - 1" = 20'
11" x 17" - 1" = 40'

OWNER: FRANCES E. MOUFLOUZE, TED W. ALEX & PATRICIA CAMERON, TRUSTEES
THE FRANCES E. MOUFLOUZE REVOCABLE TRUST OF 2015
104 LOCKE RD RYE, NH 03870

APPLICANT: GREEN & COMPANY
11 LAFAYETTE ROAD
P.O. BOX 1297
NORTH HAMPTON, NH 03862

PROJECT: RESIDENTIAL DEVELOPMENT
TAX MAP 222 LOT 11
550 SAGAMORE AVENUE
PORTSMOUTH, NH

TITLE: SITE PLAN
SHEET NUMBER: C-2

P5591



SAGAMORE AVENUE

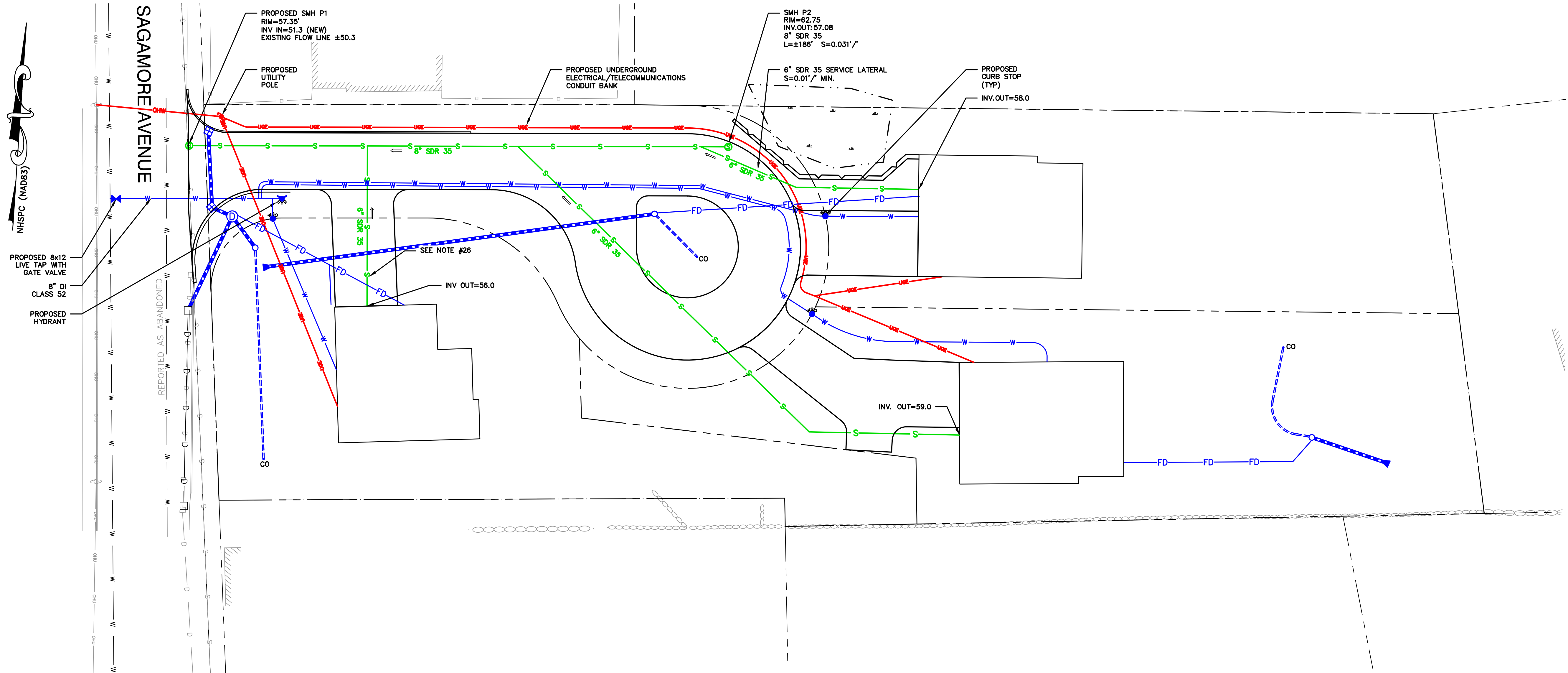

**UTILITY NOTES**

1. THE LOCATION OF ALL EXISTING UNDERGROUND UTILITIES SHOWN HEREON ARE APPROXIMATE AND ARE BASED UPON THE FIELD LOCATION OF ALL VISIBLE STRUCTURES (IE. CATCH BASINS, MANHOLES, WATER GATES, ETC.) AND INFORMATION COMPILED FROM PLANS PROVIDED BY UTILITY PROVIDERS AND GOVERNMENTAL AGENCIES. AS SUCH, THEY ARE NOT INCLUSIVE AS OTHER UTILITIES AND UNDERGROUND STRUCTURES THAT ARE NOT SHOWN ON THE PLANS MAY EXIST. THE ENGINEER, SURVEYOR AND OWNER ACCEPT NO RESPONSIBILITY FOR POTENTIAL INACCURACIES IN THE PLAN AND/OR UNFORESEEN CONDITIONS. THE CONTRACTOR SHALL NOTIFY, IN WRITING, SAID AGENCIES, UTILITY PROVIDERS, CITY OF PORTSMOUTH DPW AND OWNER'S AUTHORIZED REPRESENTATIVE AND CALL DIG SAFE AT 1 (800) DIG-SAFE AT LEAST SEVENTY-TWO (72) HOURS PRIOR TO ANY EXCAVATION WORK.
2. PRIOR TO CONSTRUCTION, IT IS THE CONTRACTOR'S RESPONSIBILITY TO LOCATE AND FIELD VERIFY JUNCTIONS, LOCATIONS AND ELEVATIONS/INVERTS OF ALL EXISTING AND PROPOSED STORMWATER AND UTILITY LINES. CONFLICTS SHALL BE ANTICIPATED AND ALL EXISTING LINES TO BE RETAINED SHALL BE PROTECTED. ANY DAMAGE DONE TO EXISTING UTILITIES SHALL BE REPAIRED AND, IF NECESSARY, EXISTING UTILITIES SHALL BE RELOCATED AT NO EXTRA COST TO THE OWNER. ALL CONFLICTS SHALL BE RESOLVED WITH THE INVOLVEMENT OF THE ENGINEER, DPW AND APPROPRIATE UTILITIES.
3. THE CONTRACTOR SHALL BE RESPONSIBLE FOR THE POSTING OF ALL BONDS AND PAYMENT OF ALL TAP, TIE-IN AND CONNECTION FEES.
4. ALL ROAD/LANE CLOSURES OR OTHER TRAFFIC INTERRUPTIONS SHALL BE COORDINATED WITH THE PORTSMOUTH POLICE DEPARTMENT AND DPW AT LEAST TWO WEEKS PRIOR TO COMMENCING RELATED CONSTRUCTION.
5. ALL CONSTRUCTION SHALL MEET THE MINIMUM CONSTRUCTION STANDARDS OF THE CITY OF PORTSMOUTH AND NHDOT STANDARD SPECIFICATIONS FOR ROADS AND BRIDGES, LATEST EDITION. THE MORE STRINGENT SPECIFICATION SHALL GOVERN.
6. CONTRACTOR SHALL BE RESPONSIBLE FOR ALL TRENCHING, BEDDING, BACKFILL & COMPACTION FOR ALL UTILITY TRENCHING IN ADDITION TO ALL CONDUIT INSTALLATION AND COORDINATION OF ALL REQUIRED INSPECTIONS.
7. ALL TRENCHING, PIPE LAYING AND BACKFILLING SHALL CONFORM TO FEDERAL OSHA AND CITY REGULATIONS.
8. FINAL UTILITY LOCATIONS TO BE COORDINATED BETWEEN THE ARCHITECT, CONTRACTOR, APPROPRIATE UTILITY COMPANIES AND THE PORTSMOUTH DPW.
9. WATER: PORTSMOUTH DPW WATER DIVISION, JIM TOW, (603) 427-1530.
10. SEWER: PORTSMOUTH DPW SEWER DIVISION, JIM TOW, (603) 427-1530.
11. TELECOMMUNICATIONS: CONSOLIDATED, JOE CONSIDINE, (603) 427-5525.
12. CABLE: COMCAST, MIKE COLLINS, (603) 679-5695, EXT. 1037.
13. ELECTRICAL: EVERSOURCE, JOSHUA LAHAIE, (603)-332-7551. ALL ELECTRIC CONDUIT INSTALLATION SHALL BE INSPECTED BY EVERSOURCE PRIOR TO BACKFILL, 48-HOUR MINIMUM NOTICE REQUIRED.
14. GAS: UNTIL, DAVID BEAULIEU, (603) 294-5144.
15. DETECTABLE WARNING TAPE SHALL BE PLACED OVER THE ENTIRE LENGTH OF ALL BURIED UTILITIES, COLORS PER THE RESPECTIVE UTILITY PROVIDERS.
16. ALL WATER MAIN AND SERVICE INSTALLATIONS SHALL BE CONSTRUCTED AND TESTED PER PORTSMOUTH DPW STANDARDS AND SPECIFICATIONS. ALL OTHER UTILITIES SHALL BE TO THE STANDARDS AND SPECIFICATIONS OF THE RESPECTIVE UTILITY PROVIDERS.
17. WHERE WATER LINES CROSS, RUN ADJACENT TO OR ARE WITHIN 5' OF STORM DRAINAGE PIPES OR STRUCTURES, 2"-THICK CLOSED CELL RIGID BOARD INSULATION SHALL BE INSTALLED FOR FROST PROTECTION.
18. PER PORTSMOUTH DPW SPECIFICATIONS, ALL NEW DUCTILE IRON WATERLINES SHALL BE WRAPPED WITH A WATER TIGHT POLYETHYLENE WRAPPING FOR THEIR FULL LENGTH, ALL DOMESTIC WATER SERVICES SHALL BE PROVIDED WITH BACKFLOW PREVENTERS AND ALL JOINTS SHALL HAVE THREE (3) WEDGES PER JOINT.
19. WATER AND SANITARY SEWER LINES SHALL BE LOCATED AT LEAST 10' HORIZONTALLY FROM EACH OTHER. WHERE CROSSING, 18" MINIMUM VERTICAL CLEARANCE SHALL BE PROVIDED WITH WATER INSTALLED OVER SEWER.
20. CONTRACTOR SHALL PROVIDE DPW WITH DETAILS OF TEMPORARY & PERMANENT GROUNDWATER DEWATERING DESIGN IF NECESSARY.
21. THE APPLICANT OR ASSIGNS SHALL AGREE TO PAY FOR THE SERVICES OF A THIRD-PARTY OVERSIGHT ENGINEER, TO BE SELECTED BY THE CITY, TO MONITOR THE INSTALLATION OF UTILITIES INCLUDING SEWER, WATER AND DRAINAGE.
22. RESIDENTIAL HOUSES SHALL BE EQUIPPED WITH NFPA 13D-COMPLIANT SPRINKLER SYSTEMS IF THEIR FRONT DOORS ARE LOCATED GREATER THAN 50' FROM THE EDGE OF ROADWAY PAVEMENT.
23. THE APPLICANT OR FUTURE HOMEOWNER'S ASSOCIATION SHALL ENTER INTO A MAINTENANCE AGREEMENT WITH THE PORTSMOUTH DPW FOR THE PROPOSED FIRE HYDRANT AND HYDRANT FLUSHING.
24. A HYDRANT FLOW TEST SHALL BE CONDUCTED EVERY FIVE YEARS IN COORDINATION WITH PORTSMOUTH DPW WATER DIVISION. THIS REQUIREMENT SHALL BE INCLUDED IN ANY HOMEOWNER'S ASSOCIATION DOCUMENTS.
25. ALL MEANS, METHODS, MATERIALS AND INSTALLATION OF NEW SEWER LATERALS SHALL BE APPROVED AND WITNESSED BY PORTSMOUTH DPW PRIOR TO BACKFILLING. SEWER LATERALS MAY BE CONSTRUCTED IN THE SAME TRENCH PROVIDED THAT A MINIMUM SEPARATION OF 3' IS MAINTAINED AND THE LINES ARE LOCATED ON THEIR RESPECTIVE LOTS IN THEIR ENTIRETY.
26. CONTRACTOR SHALL INSPECT EXISTING SEWER SERVICE TO EXISTING HOME WITH PORTSMOUTH DPW. IF CONDITION IS FOUND TO BE ACCEPTABLE AND ELEVATION VIABLE, EXISTING SERVICE CAN BE REUSED AND NEW SERVICE WILL NOT BE REQUIRED.

APPROVED BY THE PORTSMOUTH PLANNING BOARD

CHAIRMAN \_\_\_\_\_ DATE \_\_\_\_\_

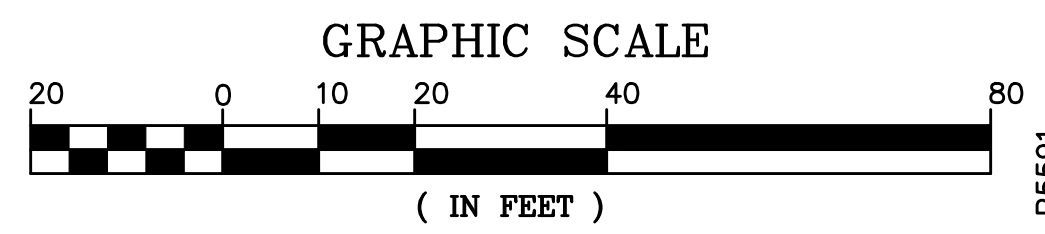

**ALTUS ENGINEERING**  
133 Court Street Portsmouth, NH 03801  
(603) 433-2335 www.altus-eng.com

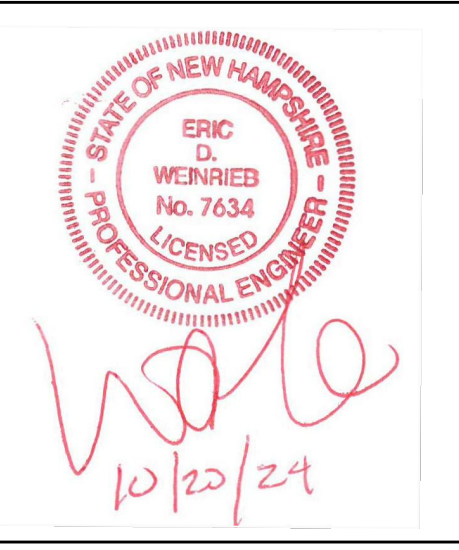

NOT FOR CONSTRUCTION

ISSUED FOR: TAC APPLICATION

ISSUE DATE: OCTOBER 23, 2024

REVISIONS

NO.	DESCRIPTION	BY	DATE
0	INITIAL SUBMISSION	EDW	09/16/24
1	PER TAC COMMENTS	EDW	10/23/24

DRAWN BY: \_\_\_\_\_ JMC  
APPROVED BY: \_\_\_\_\_ EDW  
DRAWING FILE: 5591C0-1.dwg

SCALE:  
22" x 34" - 1" = 20'  
11" x 17" - 1" = 40'

OWNER:  
FRANCES E. MOUFLOUZE,  
TED W. ALEX &  
PATRICIA CAMERON, TRUSTEES  
  
THE FRANCES E. MOUFLOUZE  
REVOCABLE TRUST OF 2015  
104 LOCKE RD  
RYE, NH 03870

APPLICANT:  
GREEN & COMPANY  
11 LAFAYETTE ROAD  
P.O. BOX 1297  
NORTH HAMPTON, NH 03862

PROJECT:  
RESIDENTIAL  
DEVELOPMENT  
  
TAX MAP 222 LOT 11  
550 SAGAMORE AVENUE  
PORTSMOUTH, NH

TITLE:  
UTILITIES PLAN  
SHEET NUMBER:  
C-3

P5591

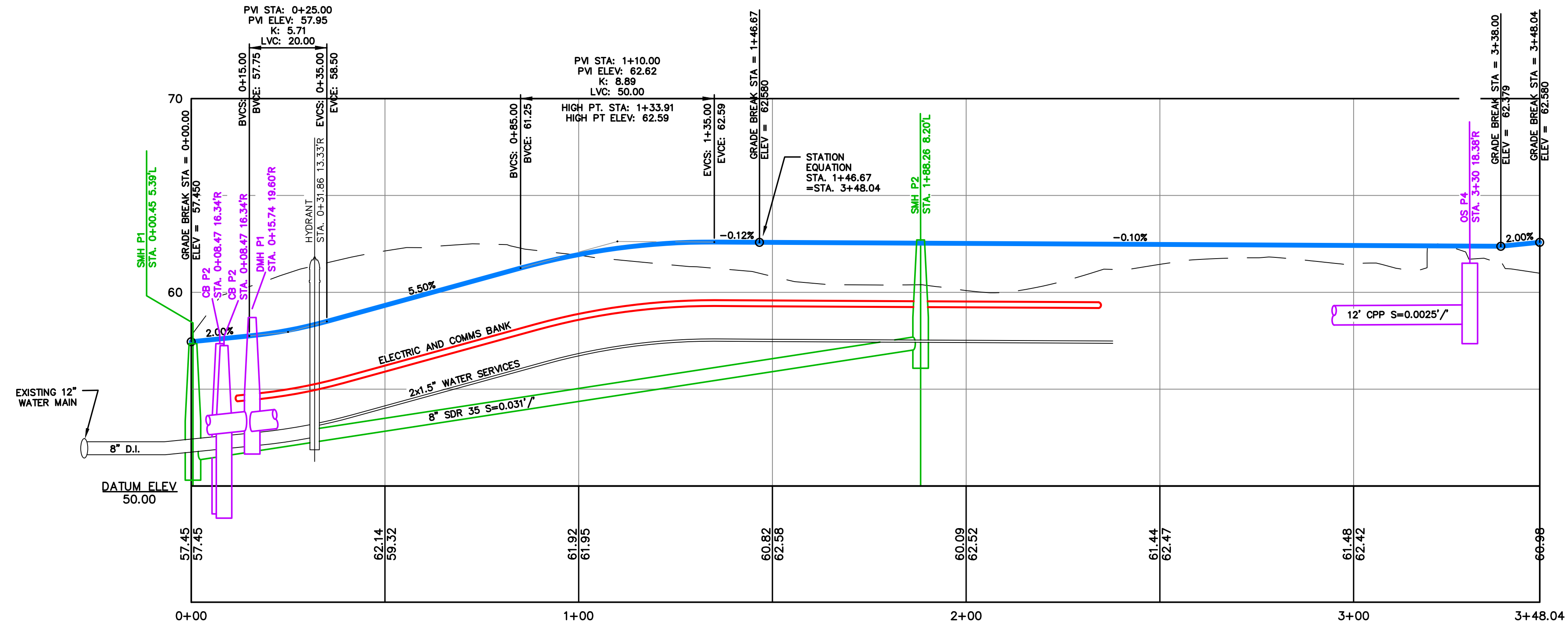
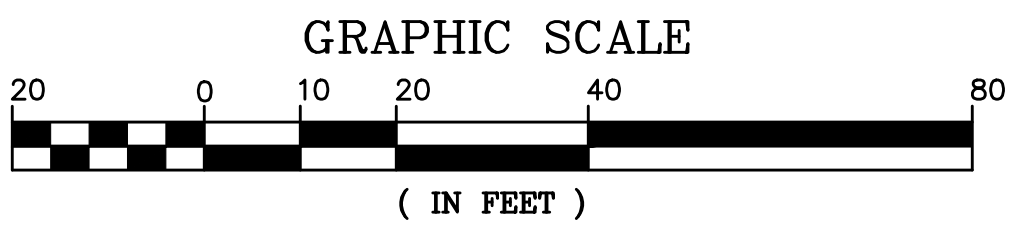
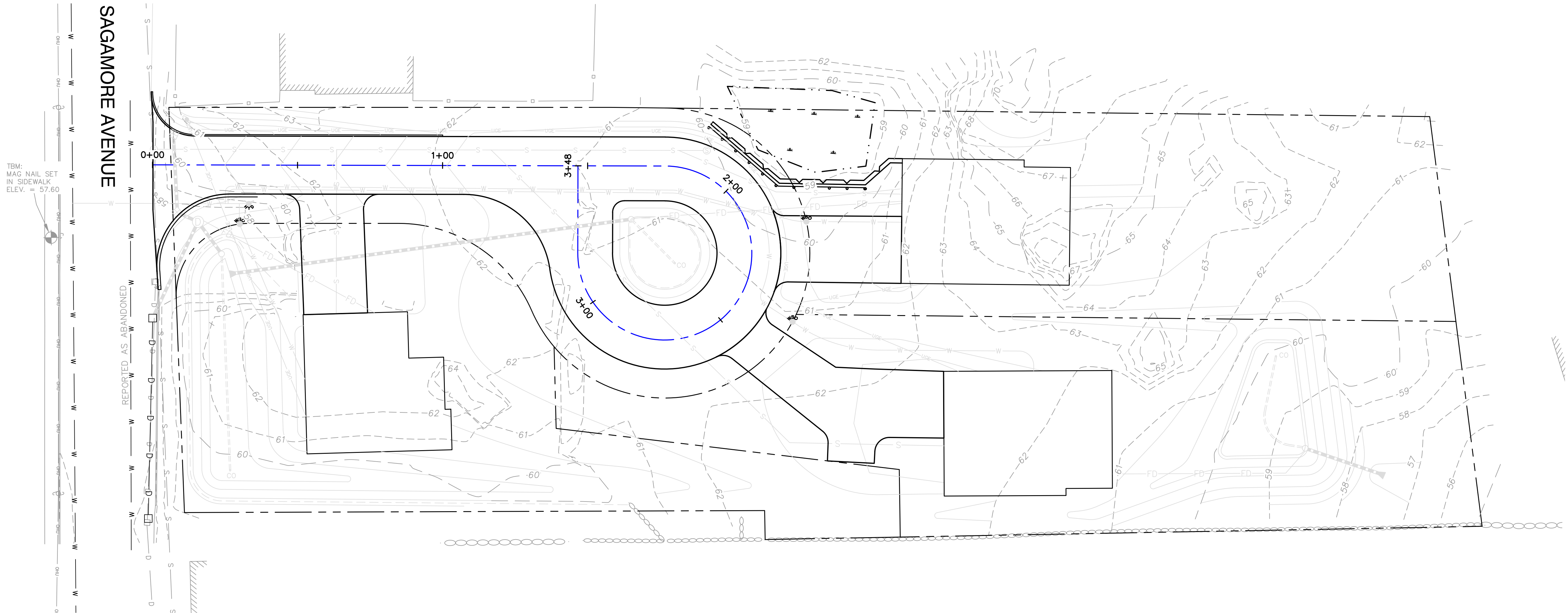
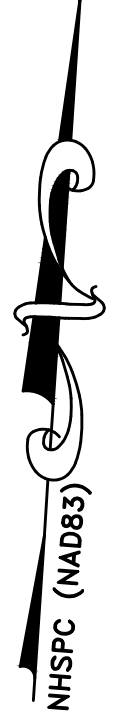

APPROVED BY THE PORTSMOUTH PLANNING BOARD  
CHAIRMAN \_\_\_\_\_ DATE \_\_\_\_\_

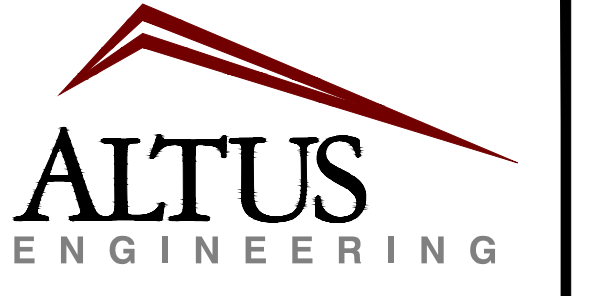

133 Court Street Portsmouth, NH 03801  
(603) 433-2335 www.altus-eng.com

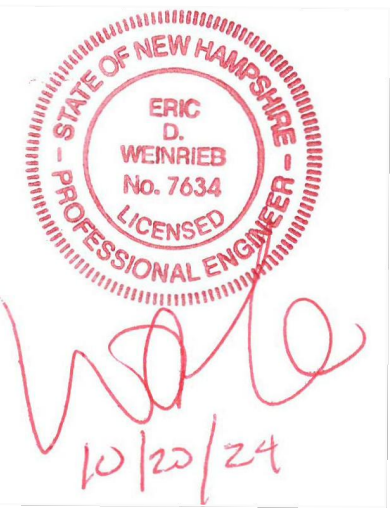

NOT FOR CONSTRUCTION

ISSUED FOR: TAC APPLICATION

ISSUE DATE: OCTOBER 23, 2024

REVISIONS		
NO.	DESCRIPTION	BY DATE
0	INITIAL SUBMISSION	EDW 09/16/24
1	PER TAC COMMENTS	EDW 10/23/24

DRAWN BY: \_\_\_\_\_ JMC  
APPROVED BY: \_\_\_\_\_ EDW  
DRAWING FILE: 5591C0-1.dwg

SCALE:  
22" x 34" - 1" = 20'  
11" x 17" - 1" = 40'

OWNER:  
FRANCES E. MOUFLOUZE,  
TED W. ALEX &  
PATRICIA CAMERON, TRUSTEES  
  
THE FRANCES E. MOUFLOUZE  
REVOCABLE TRUST OF 2015  
104 LOCKE RD  
RYE, NH 03870

APPLICANT:  
GREEN & COMPANY  
11 LAFAYETTE ROAD  
P.O. BOX 1297  
NORTH HAMPTON, NH 03862

PROJECT:  
RESIDENTIAL  
DEVELOPMENT  
  
TAX MAP 222 LOT 11  
550 SAGAMORE AVENUE  
PORTSMOUTH, NH

TITLE:  
ROADWAY PLAN AND  
PROFILE

SHEET NUMBER:  
C-4

P5591



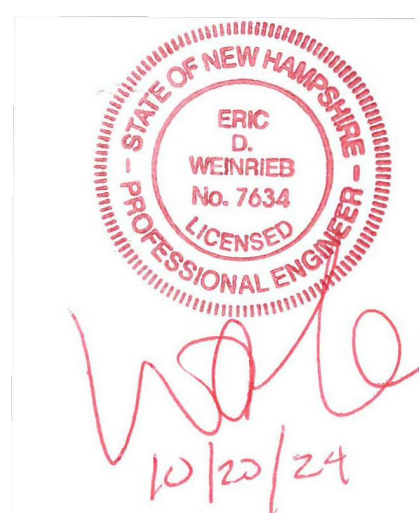

NOT FOR CONSTRUCTION

ISSUED FOR: TAC APPLICATION

ISSUE DATE: OCTOBER 23, 2024

NO.	DESCRIPTION	BY	DATE
0	INITIAL SUBMISSION	EDW	09/16/24
1	PER TAC COMMENTS	EDW	10/23/24

DRAWN BY: JMC  
APPROVED BY: EDW  
DRAWING FILE: 5591C0-1.dwg

SCALE:  
22" x 34" - 1" = 20'  
11" x 17" - 1" = 40'

OWNER:  
FRANCES E. MOUFLOUZE,  
TED W. ALEX &  
PATRICIA CAMERON, TRUSTEES

THE FRANCES E. MOUFLOUZE  
REVOCABLE TRUST OF 2015  
104 LOCKE RD  
RYE, NH 03870

APPLICANT:  
GREEN & COMPANY  
11 LAFAYETTE ROAD  
P.O. BOX 1297  
NORTH HAMPTON, NH 03862

PROJECT:  
RESIDENTIAL  
DEVELOPMENT  
TAX MAP 222 LOT 11  
550 SAGAMORE AVENUE  
PORTSMOUTH, NH

TITLE:  
GRADING AND  
DRAINAGE PLAN

SHEET NUMBER:  
C-5

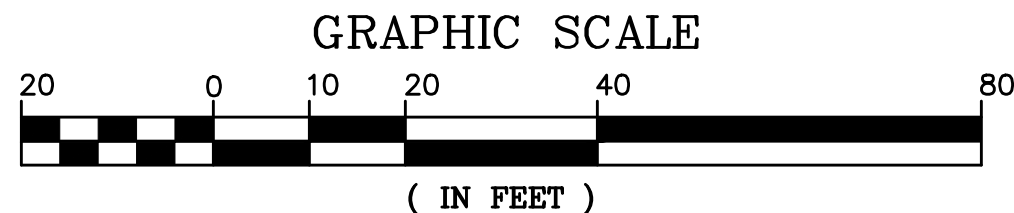
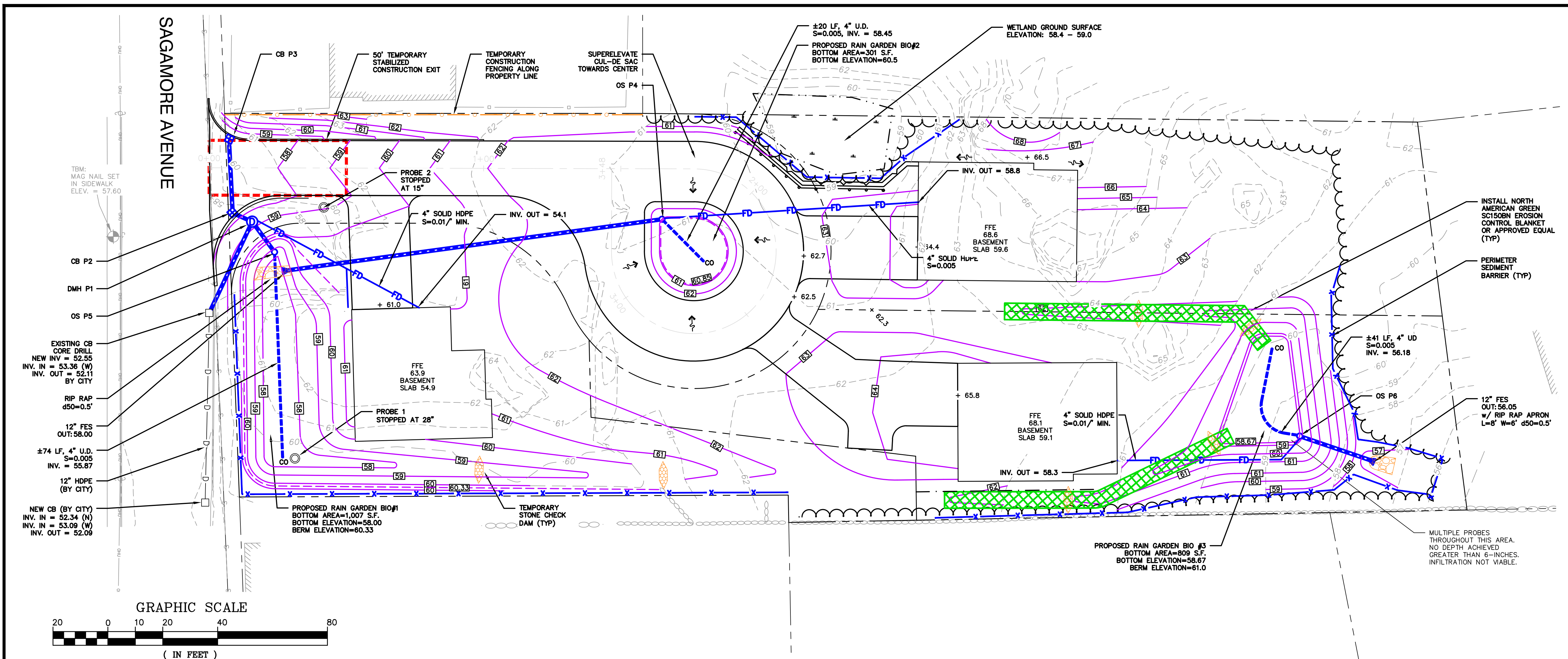

**GRADING NOTES**

- DO NOT BEGIN CONSTRUCTION UNTIL ALL STATE AND LOCAL PERMITS HAVE BEEN APPLIED FOR AND RECEIVED.
- CONTRACTOR SHALL OBTAIN A "DIGSAFE" NUMBER AT LEAST 72 HOURS PRIOR TO COMMENCING CONSTRUCTION.
- ALL CONSTRUCTION SHALL MEET THE MINIMUM CONSTRUCTION STANDARDS OF THE CITY OF PORTSMOUTH AND NHDOT STANDARD SPECIFICATIONS FOR ROAD AND BRIDGE CONSTRUCTION, LATEST EDITION. THE MORE STRINGENT SPECIFICATION SHALL GOVERN.
- ALL BENCHMARKS AND TOPOGRAPHY SHALL BE FIELD VERIFIED BY THE CONTRACTOR PRIOR TO INITIATING CONSTRUCTION.
- UNLESS OTHERWISE AGREED IN WRITING, THE CONTRACTOR SHALL BE RESPONSIBLE FOR ESTABLISHING AND MAINTAINING TEMPORARY BENCHMARKS (TBM) AND PERFORMING ALL CONSTRUCTION SURVEY LAYOUT.
- PRIOR TO CONSTRUCTION, FIELD VERIFY JUNCTIONS, LOCATIONS AND ELEVATIONS/INVERTS OF ALL EXISTING STORMWATER AND UTILITY LINES. PRESERVE AND PROTECT LINES TO BE RETAINED.
- TEMPORARY INLET PROTECTION MEASURES SHALL BE INSTALLED IN ALL EXISTING AND PROPOSED CATCH BASINS WITHIN 100' OF THE PROJECT SITE WHEN SITE WORK WITHIN CONTRIBUTING AREAS IS ACTIVE OR SAID AREAS HAVE NOT BEEN STABILIZED.
- PROTECTION OF SUBGRADE: THE CONTRACTOR SHALL BE REQUIRED TO MAINTAIN STABLE, DEWATERED SUBGRADES FOR FOUNDATIONS, PAVEMENT AREAS, UTILITY TRENCHES, AND OTHER AREAS DURING CONSTRUCTION. SUBGRADE DISTURBANCE MAY BE INFLUENCED BY EXCAVATION METHODS, MOISTURE, PRECIPITATION, GROUNDWATER CONTROL, AND CONSTRUCTION ACTIVITIES. THE CONTRACTOR SHALL TAKE PRECAUTIONS TO PREVENT SUBGRADE DISTURBANCE. SUCH PRECAUTIONS MAY INCLUDE DIVERTING STORMWATER RUNOFF AWAY FROM CONSTRUCTION AREAS, REDUCING TRAFFIC IN SENSITIVE AREAS, AND MAINTAINING AN EFFECTIVE DEWATERING PROGRAM. SOILS EXHIBITING HEAVING OR INSTABILITY SHALL BE OVER EXCAVATED TO MORE COMPETENT BEARING SOIL AND REPLACED WITH FREE DRAINING STRUCTURAL FILL. IF THE EARTHWORK IS PERFORMED DURING FREEZING WEATHER, EXPOSED SUBGRADES ARE SUSCEPTIBLE TO FROST. NO FILL OR UTILITIES SHALL BE PLACED ON FROZEN GROUND. THIS WILL LIKELY REQUIRE REMOVAL OF A FROZEN SOIL CRUST AT THE COMMENCEMENT OF EACH DAY'S OPERATIONS. THE FINAL SUBGRADE ELEVATION WOULD ALSO REQUIRE AN APPROPRIATE DEGREE OF INSULATION AGAINST FREEZING.
- IF SUITABLE, EXCAVATED MATERIALS SHALL BE PLACED AS FILL WITHIN UPLAND AREAS ONLY AND SHALL NOT BE PLACED WITHIN WETLANDS. PLACEMENT OF BORROW MATERIALS SHALL BE PERFORMED IN A MANNER THAT PREVENTS LONG TERM DIFFERENTIAL SETTLEMENT. EXCESSIVELY WET MATERIALS SHALL BE STOCKPILED AND ALLOWED TO DRAIN BEFORE PLACEMENT. FROZEN MATERIAL SHALL NOT BE USED FOR CONSTRUCTION.
- ALL CATCH BASIN, MANHOLE AND OTHER DRAINAGE RIMS SHALL BE SET FLUSH WITH OR NO LESS THAN 0.1' BELOW FINISH GRADE. ANY RIM ABOVE SURROUNDING FINISH GRADE SHALL NOT BE ACCEPTED.
- IN ORDER TO PROVIDE VISUAL CLARITY ON THE PLANS, DRAINAGE AND OTHER UTILITY STRUCTURES MAY NOT BE DRAWN TO SCALE. THE CONTRACTOR SHALL BE RESPONSIBLE FOR THE PROPER SIZING AND LOCATION OF ALL STRUCTURES AND IS DIRECTED TO RESOLVE ANY POTENTIAL DISCREPANCY WITH THE ENGINEER PRIOR TO CONSTRUCTION.
- ALL CPP PIPE SHALL BE ADS N-12 OR APPROVED EQUAL.
- NO EARTHWORK, STUMPING OR GRUBBING SHALL COMMENCE UNTIL ALL APPROPRIATE SEDIMENT AND EROSION CONTROL MEASURES HAVE BEEN INSTALLED. ALL SEDIMENT AND EROSION CONTROL MEASURES SHALL BE PROPERLY MAINTAINED IN GOOD WORKING ORDER FOR THE DURATION OF CONSTRUCTION AND THE SITE IS STABILIZED.
- SEE DETAIL SHEETS FOR PERTINENT SEDIMENT AND EROSION CONTROL DETAILS AND ADDITIONAL NOTES.
- ALL EROSION AND SEDIMENT CONTROL MEASURES SHALL BE INSTALLED IN ACCORDANCE WITH THE DESIGN STANDARDS AND SPECIFICATIONS SET FORTH IN THE NHDES NH STORMWATER MANUALS, VOL. 1-3, DATED DECEMBER 2008 AS AMENDED.
- CONTRACTOR SHALL CONTROL DUST BY SPRAYING WATER, SWEEPING PAVED SURFACES, PROVIDING TEMPORARY VEGETATION, AND/OR MULCHING EXPOSED AREAS AND STOCKPILES.
- THE CONTRACTOR SHALL TAKE WHATEVER MEANS NECESSARY TO PREVENT EROSION, PREVENT SEDIMENT FROM LEAVING THE SITE AND/OR ENTERING WETLANDS AND ENSURE PERMANENT SOIL STABILIZATION.
- ALL EROSION CONTROL BLANKETS AND FASTENERS SHALL BE BIODEGRADABLE.
- ALL SWALES AND DETENTION PONDS SHALL BE STABILIZED PRIOR TO DIRECTING RUNOFF TO THEM.
- ALL DISTURBED AREAS NOT TO BE PAVED OR OTHERWISE TREATED SHALL RECEIVE SIX (6") INCHES OF COMPACTED LOAM, LIMESTONE, ORGANIC FERTILIZER, SEED, AND MULCH USING APPROPRIATE SOIL STABILIZATION TECHNIQUES.
- UPON COMPLETION OF CONSTRUCTION, ALL DRAINAGE INFRASTRUCTURE SHALL BE CLEANED OF ALL DEBRIS AND SEDIMENT AND ALL TEMPORARY EROSION AND SEDIMENT CONTROLS REMOVED AND ANY AREAS DISTURBED BY THE REMOVAL SMOOTHED AND REVEGETATED.
- THE ENGINEER OF RECORD SHALL SUBMIT A WRITTEN REPORT WITH PHOTOGRAPHS AND ENGINEERS STAMP CERTIFYING THAT THE STORMWATER INFRASTRUCTURE WAS CONSTRUCTED TO THE APPROVED PLANS AND WILL MEET THE DESIGN PERFORMANCE.

**DRAINAGE SCHEDULE**

DMH P1 RIM=58.70 IN: 52.82' (12"x2) IN: 53.40 (4" UD) OUT: 52.72 (TO CB5) 12" CPP OUTFALL: 52.55 L=±33' S=0.005'/	CB P3 RIM=57.35 OUT: 53.06 (TO CB P2) 12" CPP OUTFALL: 52.94 L=±23' S=0.005'/	OS P5 RIM: 59.83 IN: 58.60 (2" ORIFICE) IN: 55.50 (4" UD) OUT: 53.00 (TO DMH P1) 12" CPP OUTFALL: 52.82 L=±11' S=0.0164'/
CB P2 RIM=57.25 IN: 52.94 OUT: 52.84 (TO DMH P1) 12" CPP OUTFALL: 52.82 L=±4' S=0.005'/	OS P4 RIM: 61.50 IN: 58.35 (4" UD) OUT: 58.35 (TO BIO#1) 12" CPP OUTFALL: 58.00 L=±140' S=0.0025'/	OS P6 RIM: 60.5 IN: 59.10 (5.2" ORIFICE) IN: 56.18 (PERIMETER DRAIN) IN: 56.18 (4" UD) OUT: 56.18 (TO FES) 12" CPP OUTFALL: 56.05 L=±28' S=0.005'/

APPROVED BY THE PORTSMOUTH PLANNING BOARD

CHAIRMAN \_\_\_\_\_ DATE \_\_\_\_\_

P5591

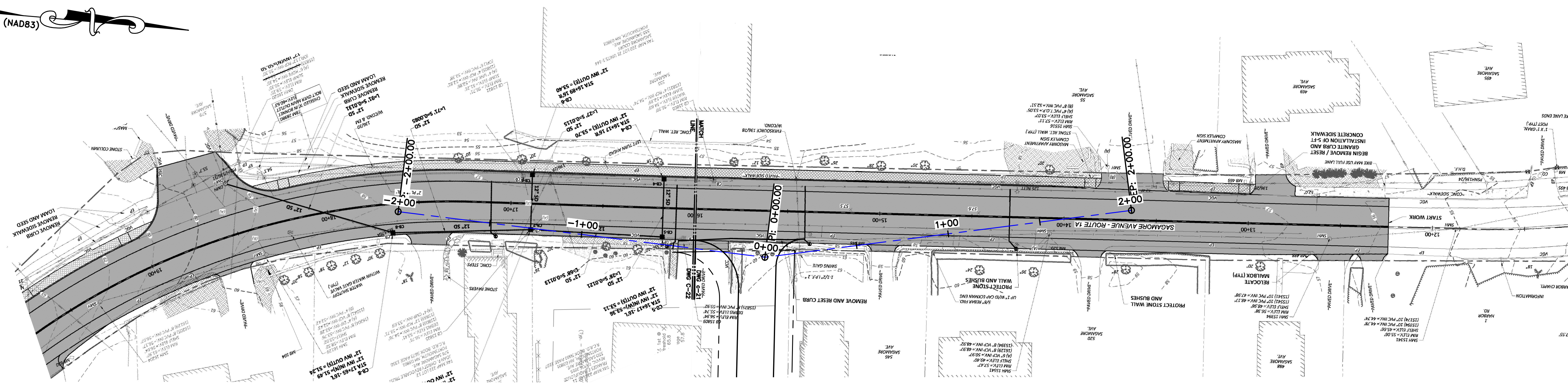
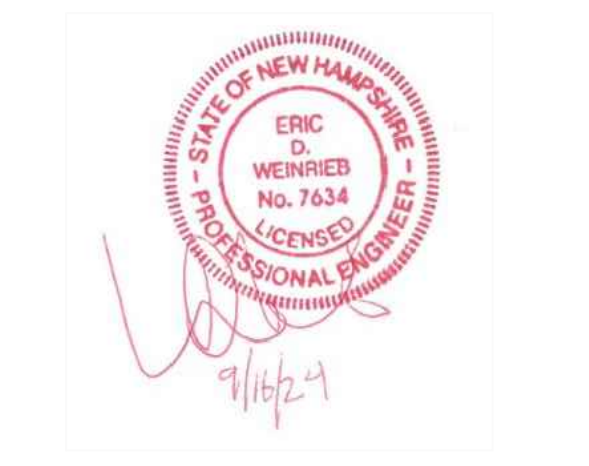

**SIGHT DISTANCE PLAN NOTES**

- CUT VEGETATION IN THE RIGHT-OF-WAY ALONG SIGHT LINES TO REMOVE VISUAL OBSTACLES.
- IN AUGUST 2024, CITY OF PORTSMOUTH DEPARTMENT OF PUBLIC WORKS DETERMINED THE 85 PERCENTILE NORTHBOUND SPEEDS WERE 29 MPH. SAGAMORE AVENUE IS UNDERGOING CONSTRUCTION, IT IS EXPECTED THAT THE SPEEDS WILL INCREASE 1 TO 2 MPH WHEN THE PROJECT IS COMPLETE.
- SAGAMORE AVENUE APPROACH GRADE IS LESS THAN 3%.
- 30 MPH DESIGN SPEED, STOPPING SIGHT DISTANCE REQUIRED 200- FEET.
- SAGAMORE AVENUE RIGHT-OF-WAY INFORMATION OBTAINED FROM CITY PLANS FOR SAGAMORE AVENUE ROADWAY IMPROVEMENTS PROJECT.

----- 200' + SIGHT LINE

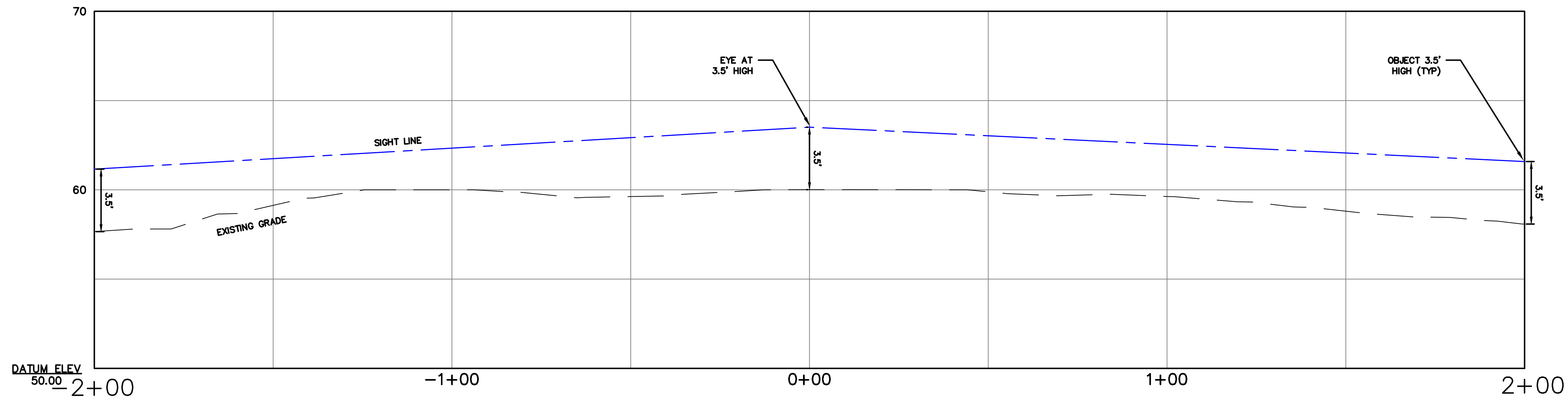
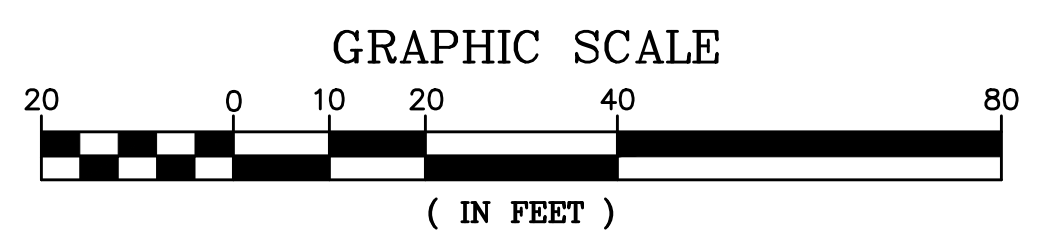

SIGHT LINE PROFILE LOOKING LEFT

SIGHT LINE PROFILE LOOKING RIGHT

APPROVED BY THE PORTSMOUTH PLANNING BOARD

CHAIRMAN \_\_\_\_\_ DATE \_\_\_\_\_

NOT FOR CONSTRUCTION  
ISSUED FOR: TAC APPLICATION  
ISSUE DATE: SEPTEMBER 16, 2024

REVISIONS	NO.	DESCRIPTION	BY	DATE
0	INITIAL SUBMISSION		EDW	09/16/24

DRAWN BY: \_\_\_\_\_ JMG  
APPROVED BY: \_\_\_\_\_ EDW  
DRAWING FILE: 5591C0-1.dwg

SCALE:  
22" x 34" - 1" = 20'  
11" x 17" - 1" = 40'

OWNER:  
FRANCES E. MOUFLOUZE,  
TED W. ALEX &  
PATRICIA CAMERON, TRUSTEES

THE FRANCES E. MOUFLOUZE  
REVOCABLE TRUST OF 2015  
104 LOCKE RD  
RYE, NH 03870

APPLICANT:  
GREEN & COMPANY  
11 LAFAYETTE ROAD  
P.O. BOX 1297  
NORTH HAMPTON, NH 03862

PROJECT:  
RESIDENTIAL  
DEVELOPMENT

TAX MAP 222 LOT 11  
550 SAGAMORE AVENUE  
PORTSMOUTH, NH

TITLE:  
SIGHT DISTANCE  
PLAN

SHEET NUMBER:  
C-6

P5591

NHSPC (NA083)

Inferno Aerial  
Inferno Aerial  
SAGAMORE AVENUE

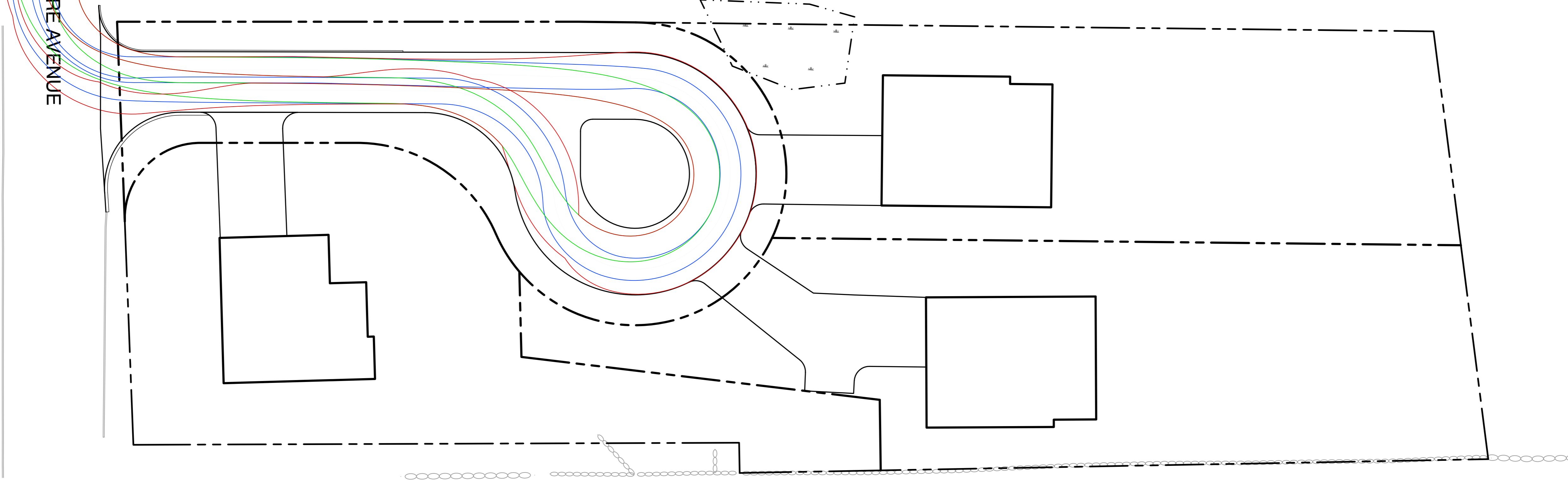

**TURNING MOVEMENT ANALYSIS NOTES**

1. DESIGN VEHICLE GEOMETRY BASED ON AASHTO STANDARDS.
2. THE GRAPHIC VEHICLE PROFILE SHOULD NOT BE CONSIDERED A COMPLETELY ACCURATE VISUAL DEPICTION OF THE DESIGN VEHICLE AND IS ONLY INTENDED TO CONVEY A GENERIC REPRESENTATION OF ITS GENERAL APPEARANCE.
3. DESIGN VEHICLE PROFILE:

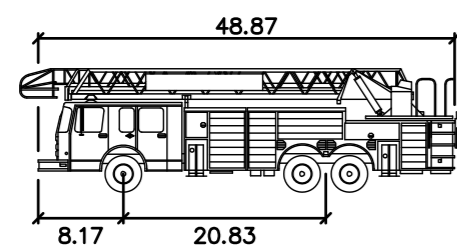

Portsmouth – Inferno  
feet  
Width : 8.50  
Track : 8.50  
Lock to Lock Time : 6.0  
Steering Angle : 41.0

**LEGEND**

- FRONT TRACK
- REAR TRACK
- VEHICLE BODY/OVERHANG

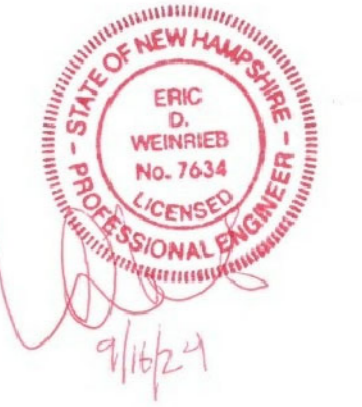

NOT FOR CONSTRUCTION

ISSUED FOR:  
**TAC APPLICATION**

ISSUE DATE:  
**SEPTEMBER 16, 2024**

NO.	DESCRIPTION	BY	DATE
0	INITIAL SUBMISSION	EDW	09/16/24

DRAWN BY: \_\_\_\_\_ JMG  
APPROVED BY: \_\_\_\_\_ EDW  
DRAWING FILE: \_\_\_\_\_ 5591CO-1.dwg

SCALE:  
22" x 34" - 1" = 20'  
11" x 17" - 1" = 40'

OWNER:  
FRANCES E. MOUFLOUZE,  
TED W. ALEX &  
PATRICIA CAMERON, TRUSTEES  
  
THE FRANCES E. MOUFLOUZE  
REVOCABLE TRUST OF 2015  
104 LOCKE RD  
RYE, NH 03870

APPLICANT:  
GREEN & COMPANY  
11 LAFAYETTE ROAD  
P.O. BOX 1297  
NORTH HAMPTON, NH 03862

PROJECT:  
**RESIDENTIAL DEVELOPMENT**  
  
TAX MAP 222 LOT 11  
550 SAGAMORE AVENUE  
PORTSMOUTH, NH

TITLE:  
**FIRE TRUCK TURNING PLAN**

SHEET NUMBER:  
**C-7**

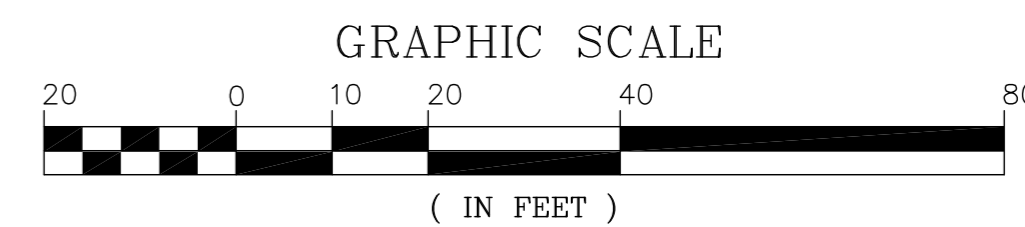

P5591

**PROJECT NAME AND LOCATION**

Owner:  
FRANCES E. MOUFLOUZE, THE FRANCES E. MOUFLOUZE REVOCABLE TRUST OF 2015  
TED W. ALEX & PATRICIA CAMERON, TRUSTEES 104 LOCKE ROAD, RYE, NH 03870

**DESCRIPTION**

The project consists of the redevelopment of a residential property on Sagamore Road. The existing building will be demolished and replaced with 3 modern single family homes. Stormwater will be managed and treated with rain gardens. Site improvements include underground utilities, landscaping and associated site improvements.

**DISTURBED AREA**

The total area to be disturbed on the parcel and for the building, driveway, drainage, and utility construction is approximately 48,000 SF±. The combined disturbed area exceeds 43,560 SF (1 acre), thus a SWPPP will be required for compliance with the USEPA-NPDES Construction General Permit. All local requirements for stormwater and erosion control during construction are still required.

**NPDES CONSTRUCTION GENERAL PERMIT**

Contractor shall be required to prepare a Stormwater Pollution Prevention Plan (SWPPP) and file an NOI (Notice of Intent) in accordance with federal storm water permit requirements under the USEPA-NPDES Construction General Permit.

**SEQUENCE OF MAJOR ACTIVITIES**

1. Prepare and file a Notice of Intent and a SWPPP with the US EPA.
2. Hold a pre-construction meeting with City & stake holders.
3. Install temporary erosion control measures, including drain inlet protection, silt fences, and stabilized construction exit/entrance.
4. Remove existing building, disconnect and remove utilities.
5. Clear and grub vegetated areas per plan; Strip and stockpile loam. Stockpiles shall be temporarily stabilized with hay bales, mulch and surrounded by a hay bale or silt fence barrier until material is removed and final grading is complete. Remove debris. Remove pavement and structures intended to be removed within the initial work limits.
6. Construct utility infrastructure. Rough grade lot to prepare for site development. Stabilize swales and stormwater management systems prior to directing flow to them.
7. Construct roadway infrastructure and foundations.
8. Construct buildings.
9. Loam and seed remaining disturbed areas.
10. When all construction activity is complete and site is stabilized, remove all silt fences and temporary structures and sediment that has been trapped by these devices.

**NAME OF RECEIVING WATER**

The site drainage discharges into a municipal closed drainage system outletting to the Little Harbor.

**TEMPORARY EROSION & SEDIMENT CONTROL AND STABILIZATION PRACTICES**

All work shall be in accordance with state and local permits. Work shall conform to the practices described in the "New Hampshire Stormwater Manual, Volumes 1 - 3", issued December 2008, as amended. As indicated in the sequence of Major Activities, the silt fences shall be installed prior to commencing any clearing or grading of the site. Structural controls shall be installed concurrently with the applicable activity. Once construction activity ceases permanently in an area, silt fences and any earth/dikes will be removed once permanent measures are established.

During construction, runoff will be diverted around the site with stabilized channels where possible. Sheet runoff from the site shall be filtered through hay bale barriers, stone check dams, and silt fences. All storm drain inlets shall be protected with hay bale filters or stone check dams. Stone rip rap shall be provided at the outlets of drain pipes and culverts where shown on the drawings.

Stabilize all ditches, swales, stormwater ponds, level spreaders and their contributing areas prior to directing flow to them.

Temporary and permanent vegetation and mulching is an integral component of the erosion and sedimentation control plan. All areas shall be inspected and maintained until vegetative cover is established. These control measures are essential to erosion prevention and also reduce costly rework of graded and shaped areas.

Temporary vegetation shall be maintained in these areas until permanent seeding is applied. Additionally, erosion and sediment control measures shall be maintained until permanent vegetation is established.

**INSTALLATION, MAINTENANCE AND INSPECTION PROCEDURES FOR TEMPORARY EROSION AND SEDIMENT CONTROL MEASURES**

**A. GENERAL**

These are general inspection and maintenance practices that shall be used to implement the plan:

1. The smallest practical portion of the site shall be denuded at one time, but in no case shall it exceed 5 acres at one time.
2. All control measures shall be inspected at least once each week and following any storm event of 0.25 inches or greater.
3. All measures shall be maintained in good working order; if a repair is necessary, it will be initiated within 24 hours.
4. Built-up sediment shall be removed from silt fence or other barriers when it has reached one-third the height of the fence or bole, or when "bulges" occur.
5. All diversion ditches shall be inspected and any breaches promptly repaired.
6. Temporary seeding and planting shall be inspected for bare spots, washouts, and unhealthy growth.
7. The owner's authorized engineer shall inspect the site on a periodic basis to review compliance with the Plans.
8. All roadways and parking lots shall be stabilized within 72 hours of achieving finished grade.
9. All cut and fill slopes shall be seeded/loamed within 72 hours of achieving finished grade.
10. An area shall be considered stable if one of the following has occurred:
  - a. Base coarse gravels have been installed in areas to be paved;
  - b. A minimum of 85% vegetated growth as been established;
  - c. A minimum of 3 inches of non-erosive material such as stone of riprap has been installed;
  - or -
  - d. Erosion control blankets have been properly installed.
11. The length of time of exposure of area disturbed during construction shall not exceed 45 days.

**B. MULCHING**

Mulch shall be used on highly erodible soils, on critically eroding areas, on areas where conservation of moisture will facilitate plant establishment, and where shown on the plans.

1. Timing - In order for mulch to be effective, it must be in place prior to major storm events. There are two (2) types of standards which shall be used to assure this:
  - a. Apply mulch prior to any storm event. This is applicable when working within 100 feet of wetlands. It will be necessary to closely monitor weather predictions, usually by contacting the National Weather Service in Concord, to have adequate warning of significant storms.
  - b. Required Mulching within a specified time period. The time period can range from 21 to 28 days of inactivity on a area, the length of time varying with site conditions. Professional judgment shall be used to evaluate the interaction of site conditions (soil erodibility, season of year, extent of disturbance, proximity to sensitive resources, etc.) and the potential impact of erosion on adjacent areas to choose an appropriate time restriction.

**INSTALLATION, MAINTENANCE AND INSPECTION PROCEDURES FOR TEMPORARY EROSION AND SEDIMENT CONTROL MEASURES (CON'T)**

**2. Guidelines for Winter Mulch Application -**

Type	Rate per 1,000 s.f.	Use and Comments
Hay or Straw	70 to 90 lbs.	Must be dry and free from mold. May be used with plantings.
Wood Chips or Bark Mulch	460 to 920 lbs.	Used mostly with trees and shrub plantings.
Jute and Fibrous Matting (Erosion Blanket)	As per manufacturer Specifications	Used in slope areas, water courses and other Control areas.
Crushed Stone 1/4" to 1-1/2" dia.	Spread more than 1/2" thick	Effective in controlling wind and water erosion.
Erosion Control Mix	2" thick (min)	* The organic matter content is between 80 and 100%, dry weight basis. * Particle size by weight is 100% passing a 6" screen and a minimum of 70 % maximum of 85% passing a 0.75" screen. * The organic portion needs to be fibrous and elongated. * Large portions of silts, clays or fine sands are not acceptable in the mix. * Soluble salts content is less than 4.0 mmhos/cm. * The pH should fall between 5.0 and 8.0.

3. Maintenance - All mulches must be inspected periodically, in particular after rainstorms, to check for hill erosion. If less than 90% of the soil surface is covered by mulch, additional mulch shall be immediately applied.

**C. TEMPORARY GRASS COVER**

1. **Seeded Preparation -**  
Apply fertilizer at the rate of 600 pounds per acre of 10-10-10. Apply limestone (equivalent to 50 percent calcium plus magnesium oxide) at a rate of three (3) tons per acre.
2. **Seeding -**
  - a. Utilize annual ryegrass at a rate of 40 lbs/acre.
  - b. Where the soil has been compacted by construction operations, loosen soil to a depth of two (2) inches before applying fertilizer, lime and seed.
  - c. Apply seed uniformly by hand, cyclone seeder, or hydroseeder (slurry including seed and fertilizer). Hydroseedings, which include mulch, may be left on soil surface. Seeding rates must be increased 10% when hydroseeding.
3. **Maintenance -**  
Temporary seedings shall be periodically inspected. At a minimum, 95% of the soil surface should be covered by vegetation. If any evidence of erosion or sedimentation is apparent, repairs shall be made and other temporary measures used in the interim (mulch, filter barriers, check dams, etc.).

**D. FILTERS**

1. Tubular Sediment Barrier
  - a. See detail.
  - b. Install per manufacturer's requirements.
2. Silt Fence (if used)
  - a. Synthetic filter fabric shall be a pervious sheet of propylene, nylon, polyester or ethylene yarn and shall be certified by the manufacturer or supplier as conforming to the following requirements:

Physical Property	Test	Requirements
Filtering Efficiency	VTM-51	75% minimum
Tensile Strength at 20% Maximum Elongation*	VTM-52	Extra Strength 50 lb/in (min) Standard Strength 30 lb/in (min)
Flow Rate	VTM-51	0.3 gal/sf/min (min)

\* Requirements reduced by 50 percent after six (6) months of installation.

Synthetic filter fabric shall contain ultraviolet ray inhibitors and stabilizer to provide a minimum of six (6) months of expected usable construction life at a temperature range of 0 degrees F to 120° F.

- b. Posts shall be spaced a maximum of ten (10) feet apart at the barrier location or as recommended by the manufacturer and driven securely into the ground (minimum of 16 inches).
  - c. A trench shall be excavated approximately six (6) inches wide and eight (8) inches deep along the line of posts and upslope from the barrier.
  - d. When standard strength filter fabric is used, a wire mesh support fence shall be fastened securely to the upslope side of the posts using heavy duty wire staples at least one (1) inch long, tie wires or hog rings. The wire shall extend no more than 36 inches above the original ground surfaces.
  - e. The "standard strength" filter fabric shall be stapled or wired to the fence, and eight (8) inches of the fabric shall be extended into the trench. The fabric shall not extend more than 36 inches above the original ground surface. Filter fabric shall not be stapled to existing trees.
  - f. When extra strength filter fabric and closer post spacing are used, the wire mesh support fence may be eliminated. In such a case, the filter fabric is stapled or wired directly to the posts with all other provisions of item (g) applying.
  - g. The trench shall be backfilled and the soil compacted over the filter fabric.
  - h. Silt fences shall be removed when they have served their useful purpose but not before the upslope areas has been permanently stabilized.
3. Sequence of Installation -  
Sediment barriers shall be installed prior to any soil disturbance of the contributing upslope drainage area.
  4. Maintenance -
    - a. Silt fence barriers shall be inspected immediately after each rainfall and at least daily during prolonged rainfall. They shall be repaired if there are any signs of erosion or sedimentation below them. Any required repairs shall be made immediately. If there are signs of undercutting at the center or the edges, or impounding of large volumes of water, the sediment barriers shall be replaced with a temporary stone check dam.
    - b. Should the fabric on a silt fence or filter barrier decompose or become ineffective prior to the end of the expected usable life and the barrier still is necessary, the fabric shall be replaced promptly.
    - c. Sediment deposits must be removed when deposits reach approximately one-third (1/3) the height of the barrier.
    - d. Any sediment deposits remaining in place after the silt fence or other barrier is no longer required shall be removed. The area shall be prepared and seeded.

- e. Additional stone may have to be added to the construction entrance, rock barrier and riprap lined swales, etc., periodically to maintain proper function of the erosion control structure.

**E. PERMANENT SEEDING -**

1. Bedding - stones larger than 1 1/2", trash, roots, and other debris that will interfere with seeding and future maintenance of the area should be removed. Where feasible, the soil should be tilled to a depth of 5" to prepare a seedbed and mix fertilizer into the soil.
2. Fertilizer - lime and fertilizer should be applied evenly over the area prior to or at the time of seeding and incorporated into the soil. Kinds and amounts of lime and fertilizer should be based on an evaluation of soil tests. When a soil test is not available, the following minimum amounts should be applied:  
Agricultural Limestone @ 100 lbs. per 1,000 s.f.  
10-20-20 fertilizer @ 12 lbs. per 1,000 s.f.
3. Seed Mixture (See Landscape Drawings for additional information):
  - 3.1. Lawn seed mix shall be a fresh, clean new seed crop. The Contractor shall furnish a dealer's guaranteed statement of the composition of the mixture and the percentage of purity and germination of each variety.
  - 3.2. Seed mixture shall consist of
    - a. 1/3 Kentucky blue,
    - b. 1/3 perennial ryegrass, and
    - c. 1/3 fine fescue.
 Turf type tall fescue is unacceptable.
4. Sodding - sodding is done where it is desirable to rapidly establish cover on a disturbed area. Sodding an area may be substituted for permanent seeding procedures anywhere on site. Bed preparation, fertilizing, and placement of sod shall be performed according to the S.C.S. Handbook. Sodding is recommended for steep sloped areas, areas immediately adjacent to sensitive water courses, easily erodible soils (fine sand/silt), etc.

**WINTER CONSTRUCTION NOTES**

1. All proposed vegetated areas which do not exhibit a minimum of 85% vegetative growth by October 15th, or which are disturbed after October 15th, shall be stabilized by seeding and installing erosion control blankets on slopes greater than 3:1, and elsewhere seeding and placing 3 to 4 tons of mulch per acre, secured with anchored netting. The installation of erosion control blankets or mulch and netting shall not occur over accumulated snow or on frozen ground and shall be completed in advance of thaw or spring melt events;
2. All ditches or swales which do not exhibit a minimum of 85% vegetative growth by October 15th, or which are disturbed after October 15th, shall be stabilized temporarily with stone or erosion control blankets appropriate for the design flow conditions; and
3. After November 15th, incomplete road or parking surfaces where work has stopped for the winter season shall be protected with a minimum of 3 inches of crushed gravel per NHDOT item 304.3.

**WINTER CONSTRUCTION NOTES**

1. All proposed vegetated areas which do not exhibit a minimum of 85% vegetative growth by October 15th, or which are disturbed after October 15th, shall be stabilized by seeding and installing erosion control blankets on slopes greater than 3:1, and elsewhere seeding and placing 3 to 4 tons of mulch per acre, secured with anchored netting. The installation of erosion control blankets or mulch and netting shall not occur over accumulated snow or on frozen ground and shall be completed in advance of thaw or spring melt events;
2. All ditches or swales which do not exhibit a minimum of 85% vegetative growth by October 15th, or which are disturbed after October 15th, shall be stabilized temporarily with stone or erosion control blankets appropriate for the design flow conditions; and
3. After November 15th, incomplete road or parking surfaces where work has stopped for the winter season shall be protected with a minimum of 3 inches of crushed gravel per NHDOT item 304.3.

**Long Term Inspection & Maintenance Schedule**

	Spring	Fall or Yearly	After Major Storm	Every 2-5 Years
<b>Vegetated Areas</b>				
Inspect all slopes and embankments	x		x	
Replant bare areas or areas with sparse growth	x		x	
Armor areas with hill erosion with an appropriate lining or divert the erosive flows to on-site areas able to withstand concentrated flows.	x		x	
<b>Stormwater Channels</b>				
Inspect ditches, swales and other open stormwater channels	x	x	x	
Remove any obstructions and accumulated sediments or debris	x	x		
Control vegetated growth and woody vegetation		x		
Repair any erosion of the ditch lining		x		
Mow vegetated ditches		x		
Remove woody vegetation growing through riprap		x		
Repair any slumping side slopes		x		
Replace riprap where underlying filter fabric or underdrain gravel is exposed or where stones have been dislodged		x		
<b>Culverts</b>				
Remove accumulated sediments and debris at inlet, outlet and within the conduit	x	x	x	
Repair any erosion damage at the culvert's inlet and outlet	x	x	x	
Remove woody vegetation growing through riprap		x		
<b>Roadways and Parking Surfaces</b>				
Remove accumulated water sand along roadways	x			
Sweep pavement to remove sediment	x			
Grade road shoulders and remove excess sand either manually or by a front-end loader	x			
Grade gravel roads and gravel shoulders	x			
Clean out sediment contained in water bars or open-top culverts	x			
Ensure that stormwater is not impeded by accumulations of material or false ditches in the roadway shoulder	x			
<b>Runoff Infiltration Facilities</b>				
Remove dead vegetation and any accumulated sediment (normally at the entrance to the garden) to allow for new growth	x			
Weed, add additional hardwood mulch to suppress weeds	x	x		
<b>Mow turf three (3) times a growing season</b>				
Aerate areas with deep tines, if water ponds on the surface for more than 24 hours during the first year or for a length of 72 hours			x	
<b>Vegetative Swale</b>				
Mow grass swales monthly				
Inspect swale following significant rainfall event	x	x	x	
Control vegetated growth and woody vegetation	x	x		
Repair any erosion of the ditch	x	x		
Remove debris and litter as necessary	x	x		

APPROVED BY THE PORTSMOUTH PLANNING BOARD  
CHAIRMAN \_\_\_\_\_ DATE \_\_\_\_\_

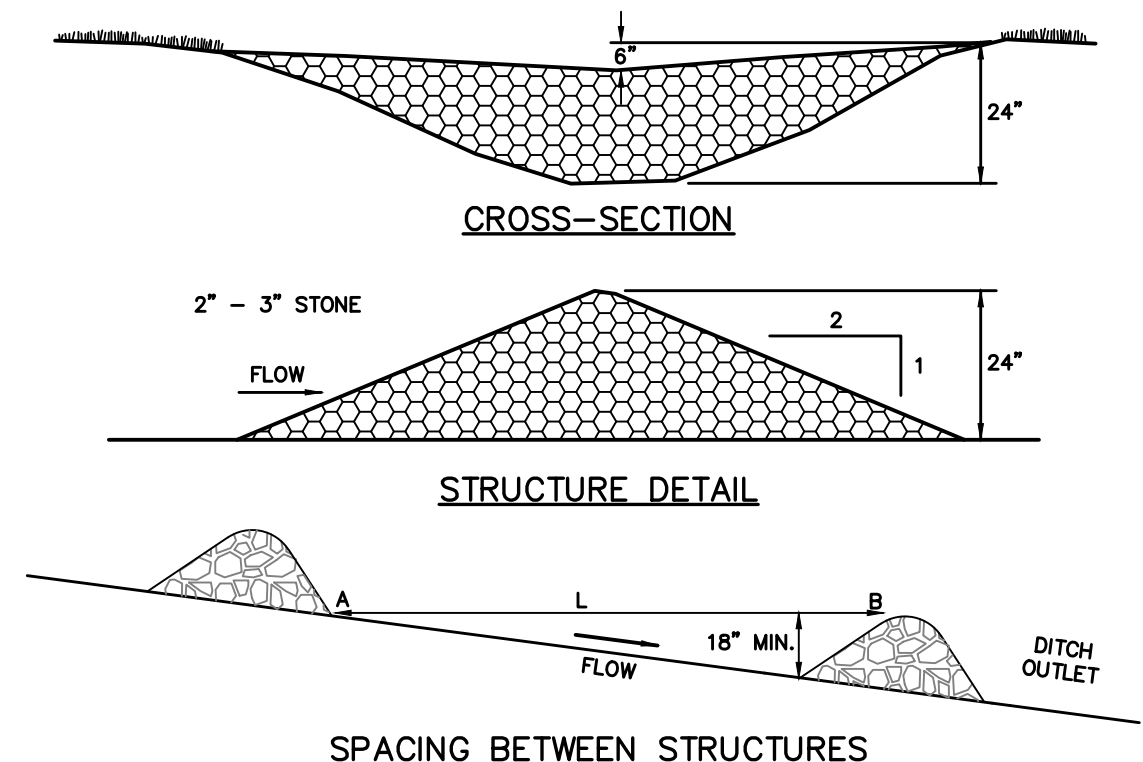

**SPACING BETWEEN STRUCTURES**

1. L = DISTANCE SUCH THAT POINTS A AND B ARE OF EQUAL ELEVATION
2. CHECK DAM SHALL BE CONSTRUCTED OF 2" TO 3" STONE WITH COMPLETE COVERAGE OF DITCH OR SWALE TO INSURE THAT THE CENTER OF THE STRUCTURE IS LOWER THAN THE EDGES.

**MAINTENANCE**

TEMPORARY GRADE STABILIZATION STRUCTURES SHOULD BE CHECKED AFTER EACH RAINFALL AND AT LEAST DAILY DURING PROLONGED STORMS. ANY NECESSARY REPAIRS SHOULD BE MADE IMMEDIATELY. PARTICULAR ATTENTION SHOULD BE GIVEN TO END RUN AND CROSSON AT THE DOWNSTREAM TOE OF THE STRUCTURE. WHEN THE STRUCTURES ARE REMOVED, THE DISTURBED PORTION SHOULD BE BROUGHT TO THE EXISTING CHANNEL GRADE AND THE AREAS PREPARED, SEEDING, AND MULCHED. WHILE THIS PRACTICE IS NOT INTENDED TO BE USED PRIMARILY FOR SEDIMENT TRAPPING, SOME SEDIMENT WILL ACCUMULATE BEHIND THE STRUCTURES. SEDIMENT SHALL BE REMOVED FROM BEHIND THE STRUCTURES WHEN IT HAS ACCUMULATED TO ONE HALF OF THE ORIGINAL HEIGHT OF THE STRUCTURE.

**CONSTRUCTION SPECIFICATIONS**

1. STRUCTURES SHALL BE INSTALLED ACCORDING TO THE DIMENSIONS SHOWN ON THE PLANS AT THE APPROPRIATE SPACING.
2. CONSTRUCTION OPERATIONS SHALL BE CARRIED OUT IN SUCH A MANNER SO THAT EROSION AND AIR AND WATER POLLUTION WILL BE MINIMIZED.
3. SEEDING, FERTILIZING, AND MULCHING SHALL CONFORM TO THE RECOMMENDATIONS IN THE APPROPRIATE VEGETATIVE BMP.
4. STRUCTURES SHALL BE REMOVED FROM THE CHANNEL WHEN THEIR USEFUL LIFE HAS BEEN COMPLETED.

**TEMPORARY EROSION CONTROL CHECK DAM NOT TO SCALE**

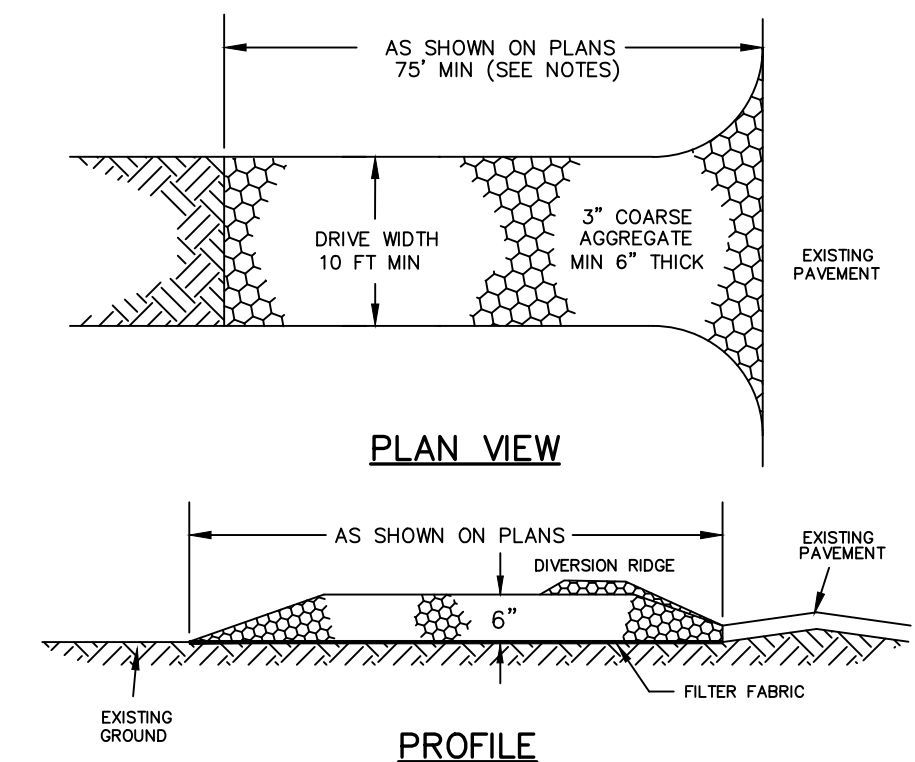

**CONSTRUCTION SPECIFICATIONS**

1. REFERENCE NEW HAMPSHIRE STORMWATER MANUAL VOLUME 3 (LATEST EDITION), SECTION 4.2 "TEMPORARY CONSTRUCTION EXIT" REQUIREMENTS AND BMP DETAIL.
2. STONE SIZE - 3" COARSE AGGREGATE
3. THICKNESS - SIX (6) INCHES (MINIMUM).
4. LENGTH - 75 FOOT MINIMUM, OR 50 FOOT ALLOWED WHEN DIVERSION RIDGE IS PROVIDED.
5. WIDTH - 1/2 OF DRIVEWAY (10 FOOT MINIMUM).
6. FILTER FABRIC - MIRAFI 600X OR APPROVED EQUAL.
7. SURFACE WATER CONTROL - ALL SURFACE WATER THAT IS FLOWING TO OR DIVERTED TOWARD THE CONSTRUCTION ENTRANCE SHALL BE PIPED BENEATH THE ENTRANCE. IF PIPING IS IMPRACTICAL, A BERM WITH 5:1 SLOPES THAT CAN BE CROSSED BY VEHICLES MAY BE SUBSTITUTED FOR THE PIPE.
8. MAINTENANCE - THE ENTRANCE SHALL BE MAINTAINED IN A CONDITION WHICH WILL PREVENT TRACKING OR FLOWING OF SEDIMENT ONTO PUBLIC RIGHTS-OF-WAY. THIS WILL REQUIRE PERIODIC TOP DRESSING WITH ADDITIONAL STONE OR ADDITIONAL LENGTH AS CONDITIONS DEMAND AND REPAIR AND/OR CLEANOUT OF ANY MEASURES USED TO TRAP SEDIMENT. ALL SEDIMENT SPILLED, DROPPED, WASHED OR TRACKED ONTO PUBLIC RIGHTS-OF-WAY MUST BE REMOVED IMMEDIATELY.
9. WHEELS SHALL BE CLEANED TO REMOVE MUD PRIOR TO ENTRANCE ONTO PUBLIC RIGHTS-OF-WAY. WHEN WASHING IS REQUIRED, IT SHALL BE DONE ON AN AREA STABILIZED WITH STONE WHICH DRAINS INTO AN APPROVED SEDIMENT TRAPPING DEVICE.

**STABILIZED CONSTRUCTION EXIT NOT TO SCALE**

NOTE: ALL FACILITIES SHOULD BE INSPECTED ON AN ANNUAL BASIS AT A MINIMUM. IN ADDITION, ALL FACILITIES SHOULD BE INSPECTED AFTER A SIGNIFICANT PRECIPITATION EVENT TO ENSURE THE FACILITY IS DRAINING APPROPRIATELY AND TO IDENTIFY ANY DAMAGE THAT OCCURRED AS A RESULT OF THE INCREASED RUNOFF. FOR THE PURPOSE OF THIS STORMWATER MANAGEMENT PROGRAM, A SIGNIFICANT RAINFALL EVENT IS CONSIDERED AN EVENT OF THREE (3) INCHES IN A 24-HOUR PERIOD OR 0.25 INCHES IN A ONE-HOUR PERIOD. IT IS ANTICIPATED THAT A SHORT INTENSE EVENT IS LIKELY TO HAVE A HIGHER POTENTIAL OF EROSION FOR THIS SITE THAN A LONGER, HIGH VOLUME EVENT.

**ALTUS ENGINEERING**  
133 Court Street Portsmouth, NH 03801  
(603) 433-2335 www.altus-eng.com

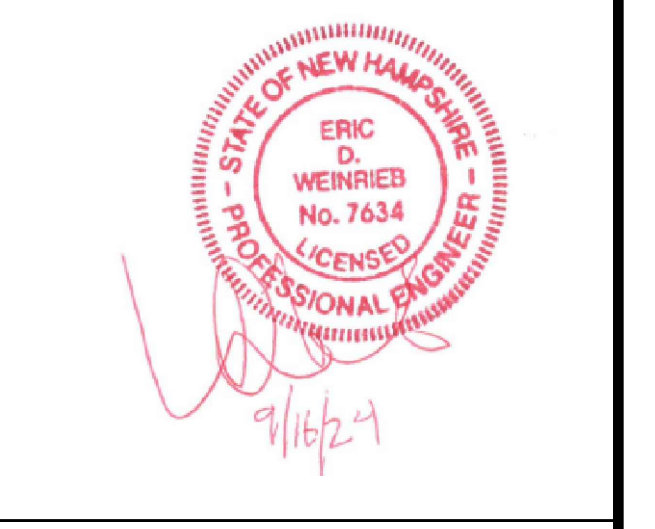

NOT FOR CONSTRUCTION  
ISSUED FOR: TAC APPLICATION  
ISSUE DATE: SEPTEMBER 16, 2024

NO.	DESCRIPTION	BY	DATE
0	INITIAL SUBMISSION	EDW	09/16/24

DRAWN BY: \_\_\_\_\_ JMG  
APPROVED BY: \_\_\_\_\_ EDW  
DRAWING FILE: 5991-DETAILS.dwg

SCALE: NOT TO SCALE

OWNER:  
FRANCES E. MOUFLOUZE,  
TED W. ALEX &  
PATRICIA CAMERON, TRUSTEES  
  
THE FRANCES E. MOUFLOUZE  
REVOCABLE TRUST OF 2015  
104 LOCKE RD  
RYE, NH 03870

APPLICANT:  
  
GREEN & COMPANY  
11 LAFAYETTE ROAD  
P.O. BOX 1297  
NORTH HAMPTON, NH  
03862

PROJECT:  
  
PROPOSED 3 LOT  
SUBDIVISION  
TAX MAP 222, LOT 11  
  
550 SAGAMORE ROAD  
PORTSMOUTH, NH 03801

TITLE:  
  
EROSION CONTROL  
NOTES & DETAILS  
  
SHEET NUMBER:  
  
D-1

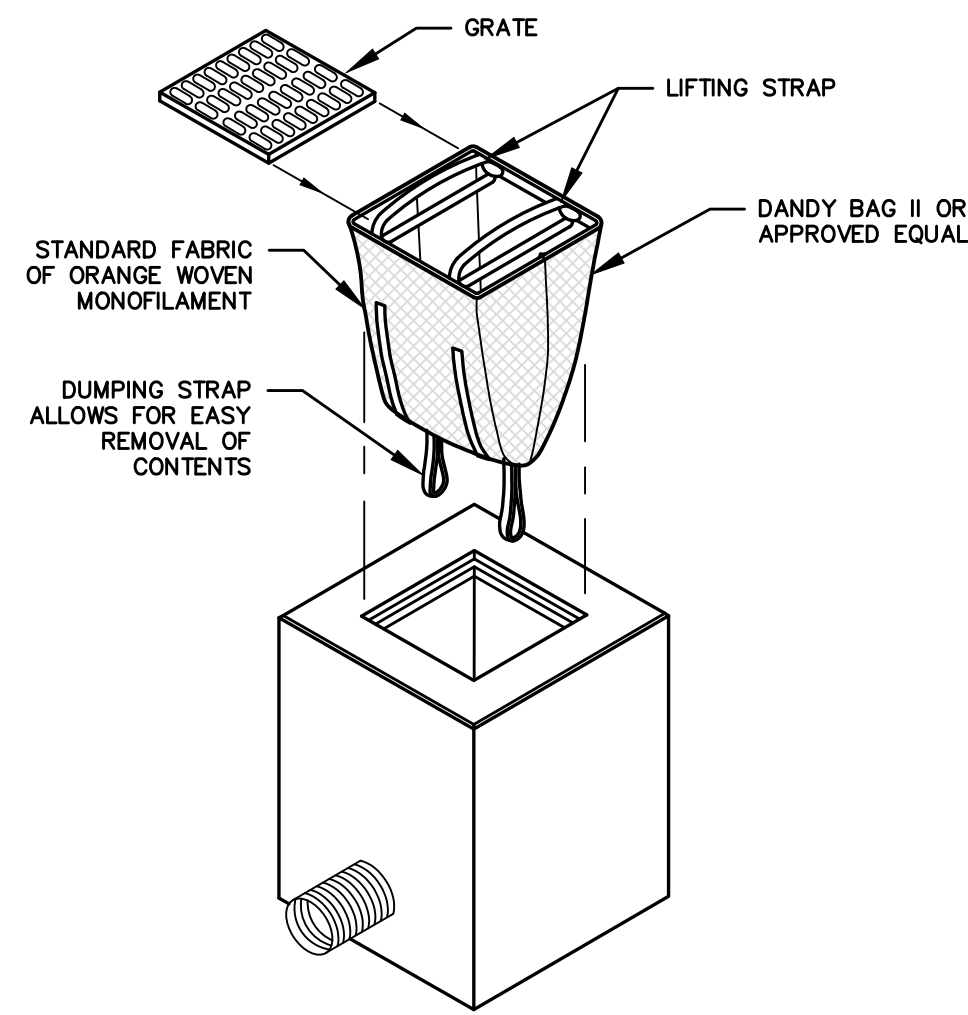

**INSTALLATION AND MAINTENANCE:**

**INSTALLATION:** REMOVE THE GRATE FROM CATCH BASIN. IF USING OPTIONAL OIL ABSORBENTS, PLACE ABSORBENT PILLOW IN UNIT. STAND GRATE ON END. MOVE THE TOP LIFTING STRAPS OUT OF THE WAY AND PLACE THE GRATE INTO CATCH BASIN. INSERT SO THE GRATE IS BELOW THE TOP STRAPS AND ABOVE THE LOWER STRAPS. HOLDING THE LIFTING DEVICES, INSERT THE GRATE INTO THE INLET.

**MAINTENANCE:** REMOVE ALL ACCUMULATED SEDIMENT AND DEBRIS FROM VICINITY OF THE UNIT AFTER EACH STORM EVENT. AFTER EACH STORM EVENT AND AT REGULAR INTERVALS, LOOK INTO THE CATCH BASIN INSERT. IF THE CONTAINMENT AREA IS MORE THAN 1/3 FULL OF SEDIMENT, THE UNIT MUST BE EMPTIED. TO EMPTY THE UNIT, LIFT THE UNIT OUT OF THE INLET USING THE LIFTING STRAPS AND REMOVE THE GRATE. IF USING OPTIONAL ABSORBENTS, REPLACE ABSORBENT WHEN NEAR SATURATION.

**UNACCEPTABLE INLET PROTECTION METHOD:**

A SIMPLE SHEET OF GEOTEXTILE UNDER THE GRATE IS NOT ACCEPTABLE.

**STORM DRAIN INLET PROTECTION NOT TO SCALE**

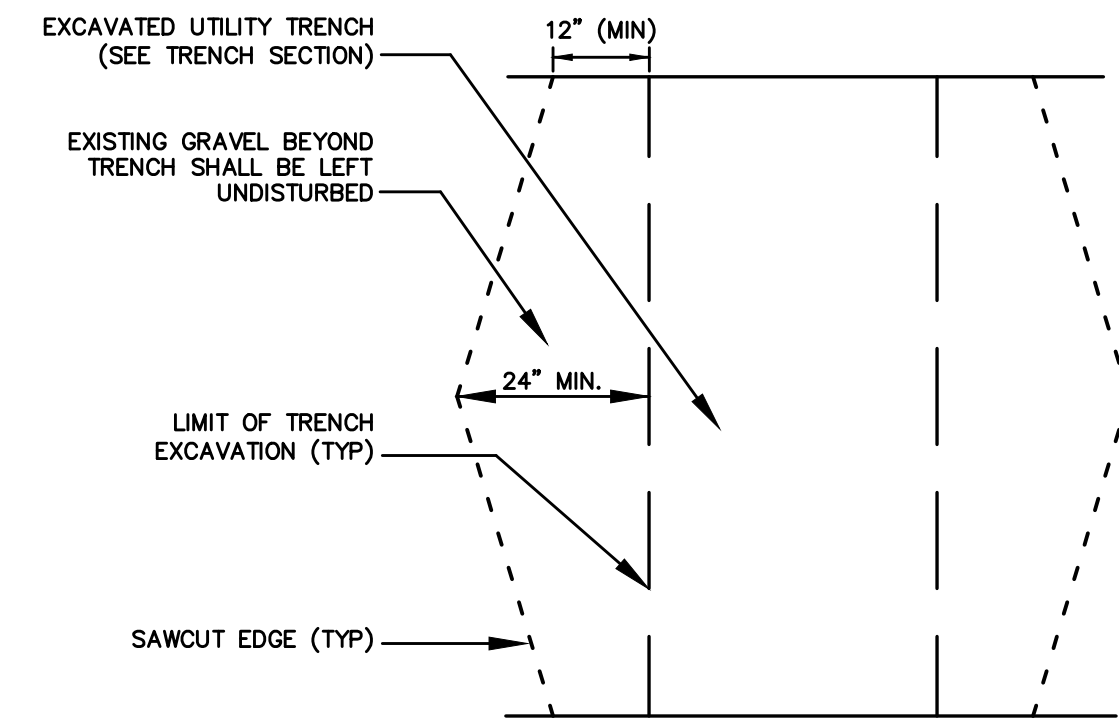

PLAN

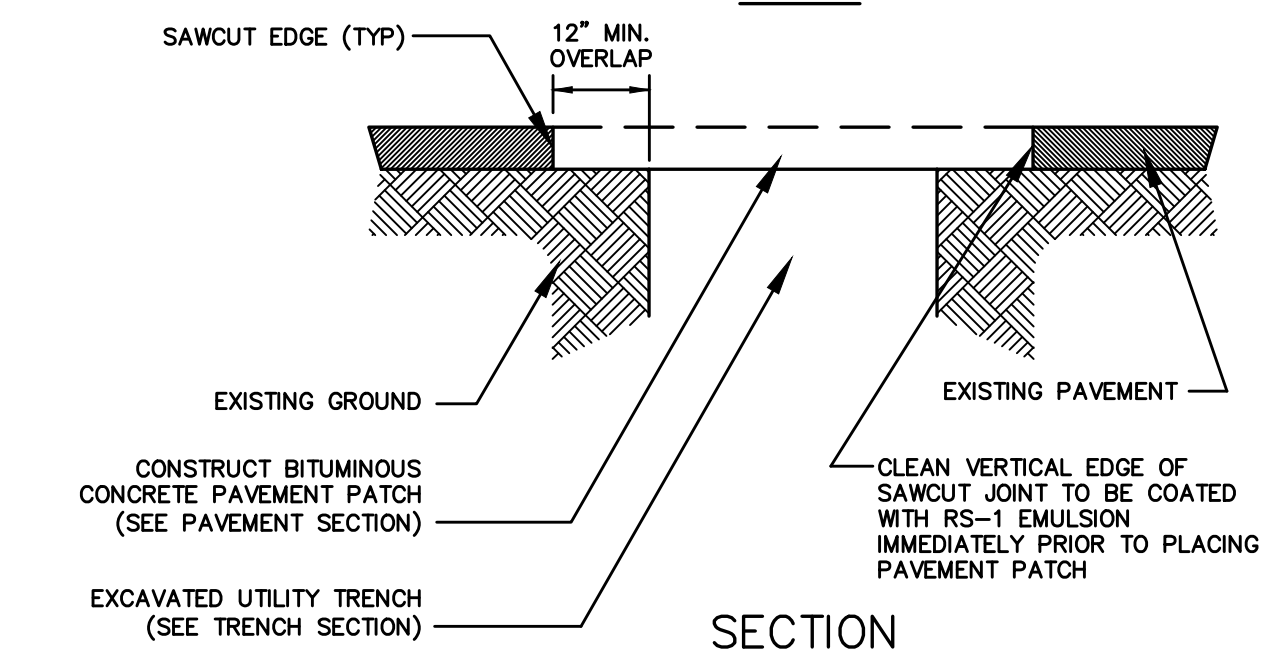

SECTION

**NOTES**

1. MACHINE CUT EXISTING PAVEMENT.
2. ALL TEMPORARY, DAMAGED OR DEFECTIVE PAVEMENT SHALL BE REMOVED PRIOR TO PLACEMENT OF PERMANENT TRENCH REPAIRS.
3. DIAMOND PATCHES, SHALL BE REQUIRED FOR ALL TRENCHES CROSSING ROADWAY. DIAMOND PATCHES SHALL MEET NHDOT REQUIREMENTS.

**TYPICAL TRENCH PATCH NOT TO SCALE**

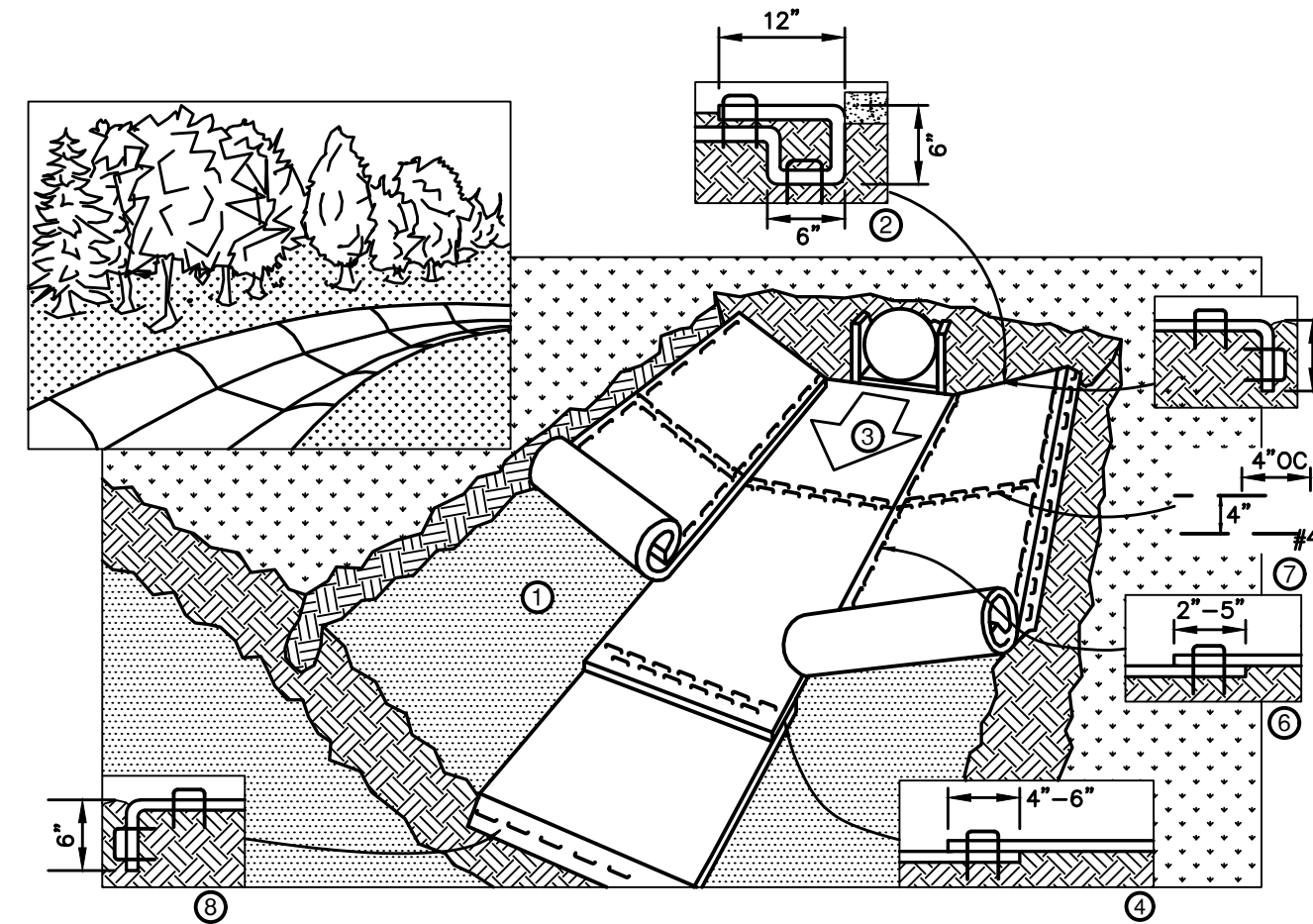

**NOTES**

1. PREPARE SOIL BEFORE INSTALLING BLANKETS, INCLUDING ANY NECESSARY APPLICATION OF LIME, FERTILIZER, AND SEED.
2. BEGIN AT THE TOP OF THE CHANNEL BY ANCHORING THE BLANKET IN A 6" DEEP BY 6" WIDE TRENCH WITH APPROXIMATELY 12" OF BLANKET EXTENDED BEYOND THE UP-SLOPE PORTION OF THE TRENCH. ANCHOR THE BLANKET WITH A ROW OF STAPLES/STAKES APPROXIMATELY 12" APART IN THE BOTTOM OF THE TRENCH. BACKFILL AND COMPACT THE TRENCH AFTER STAPLING. APPLY SEED TO COMPACTED SOIL AND FOLD REMAINING 12" PORTION OF BLANKET BACK OVER SEED AND COMPACTED SOIL. SECURE BLANKET OVER COMPACTED SOIL WITH A ROW OF STAPLES/STAKES SPACED APPROXIMATELY 12" APART ACROSS THE WIDTH OF THE BLANKET.
3. ROLL CENTER BLANKET IN DIRECTION OF WATER FLOW IN BOTTOM OF CHANNEL. BLANKETS WILL UNROLL WITH APPROPRIATE SIDE AGAINST THE SOIL SURFACE. ALL BLANKETS MUST BE SECURELY FASTENED TO SOIL SURFACE BY PLACING STAPLES/STAKES IN APPROPRIATE LOCATIONS AS SHOWN IN THE STAPLE PATTERN GUIDE.
4. PLACE CONSECUTIVE BLANKETS END OVER END (SHINGLE STYLE) WITH A 4"-6" OVERLAP. USE A DOUBLE ROW OF STAPLES STAGGERED 4" APART AND 4" ON CENTER TO SECURE BLANKETS.
5. FULL LENGTH EDGE OF BLANKETS AT TOP OF SIDE SLOPES MUST BE ANCHORED WITH A ROW OF STAPLES/STAKES APPROXIMATELY 12" APART IN A 6" DEEP BY 6" WIDE TRENCH. BACKFILL AND COMPACT THE TRENCH AFTER STAPLING.
6. ADJACENT BLANKETS MUST BE OVERLAPPED APPROXIMATELY 2"-5" (DEPENDING ON BLANKET TYPE) AND STAPLED. TO INSURE PROPER SEAM ALIGNMENT, PLACE THE EDGE OF THE OVERLAPPING BLANKET (BLANKET BEING INSTALLED ON TOP) EVEN WITH THE COLORED SEAM STITCH ON THE BLANKET BEING OVERLAPPED.
7. IN HIGH FLOW CHANNEL APPLICATIONS, A STAPLE CHECK SLOT IS RECOMMENDED AT 30 TO 40 FOOT INTERVALS. USE A DOUBLE ROW OF STAPLES STAGGERED 4" APART AND 4" ON CENTER OVER ENTIRE WIDTH OF THE CHANNEL.
8. THE TERMINAL END OF THE BLANKETS MUST BE ANCHORED WITH A ROW OF STAPLES/STAKES APPROXIMATELY 12" APART IN A 6" DEEP BY 6" WIDE TRENCH. BACKFILL AND COMPACT THE TRENCH AFTER STAPLING.

**CRITICAL POINTS:**

- A. OVERLAPS AND SEAMS
- B. PROJECTED WATER LINE
- C. CHANNEL BOTTOM/SIDE SLOPE VERTICES

**NOTES:**

- \* HORIZONTAL STAPLE SPACING SHOULD BE ALTERED IF NECESSARY TO ALLOW STAPLES TO SECURE THE CRITICAL POINTS ALONG THE CHANNEL SURFACE.
- \*\* IN LOOSE SOIL CONDITIONS, THE USE OF STAPLE OR STAKE LENGTHS GREATER THAN 6" MAY BE NECESSARY TO PROPERLY ANCHOR THE BLANKETS.

**EROSION CONTROL BLANKET - SWALE NOT TO SCALE**

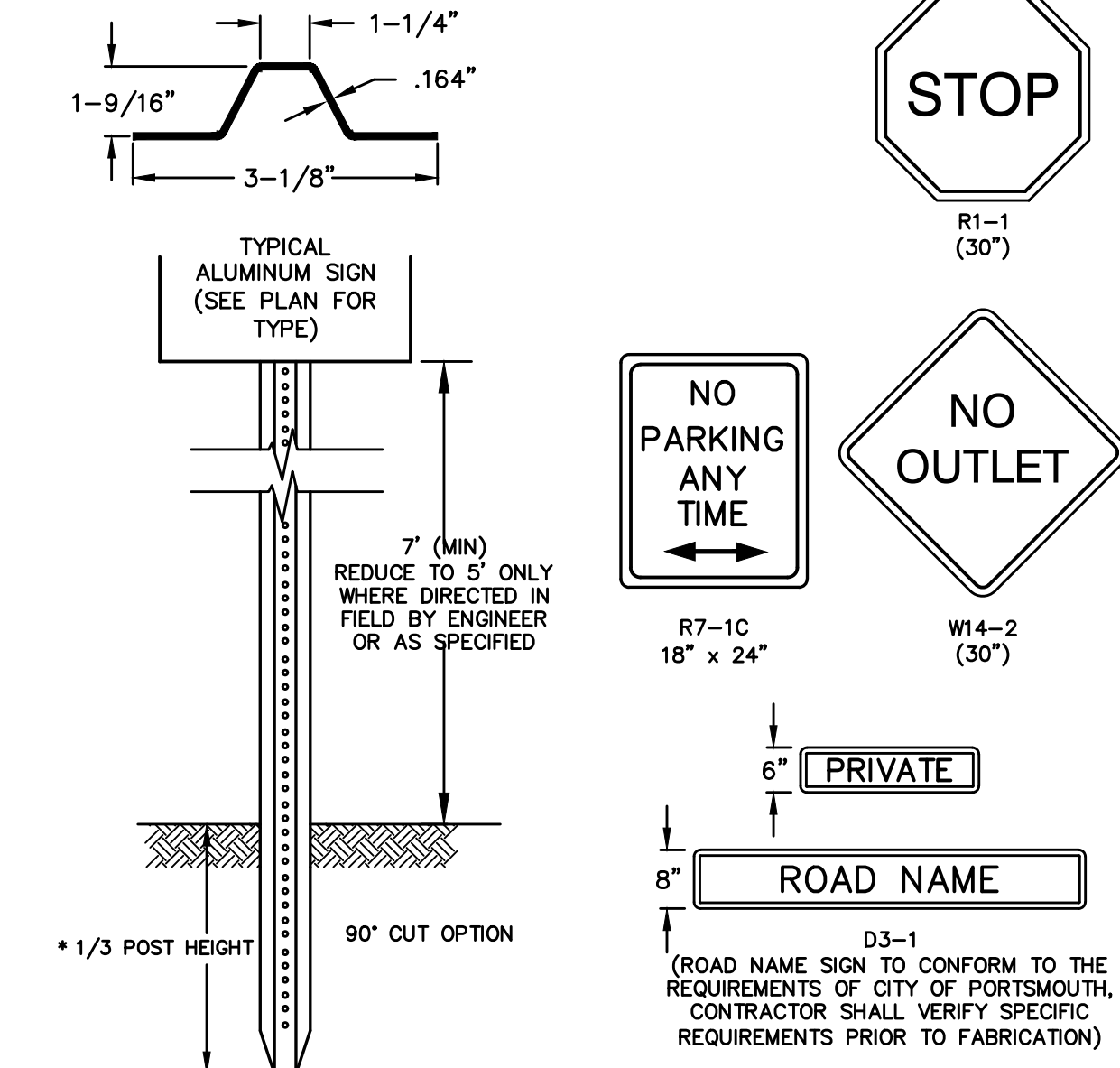

LENGTH: AS REQUIRED

WEIGHT PER LINEAR FOOT: 2.50 LBS (MIN.)

HOLES: 3/8" DIAMETER, 1" C-C FULL LENGTH

STEEL: SHALL CONFORM TO ASTM A-499 (GRADE 60) OR ASTM A-576 (GRADE 1070 - 1080)

**NOTES**

1. ALL SIGNS SHALL MEET THE REQUIREMENTS OF AND BE INSTALLED AS INDICATED IN THE MANUAL ON UNIFORM TRAFFIC CONTROL DEVICES, LATEST EDITION.

**SIGN DETAILS NOT TO SCALE**

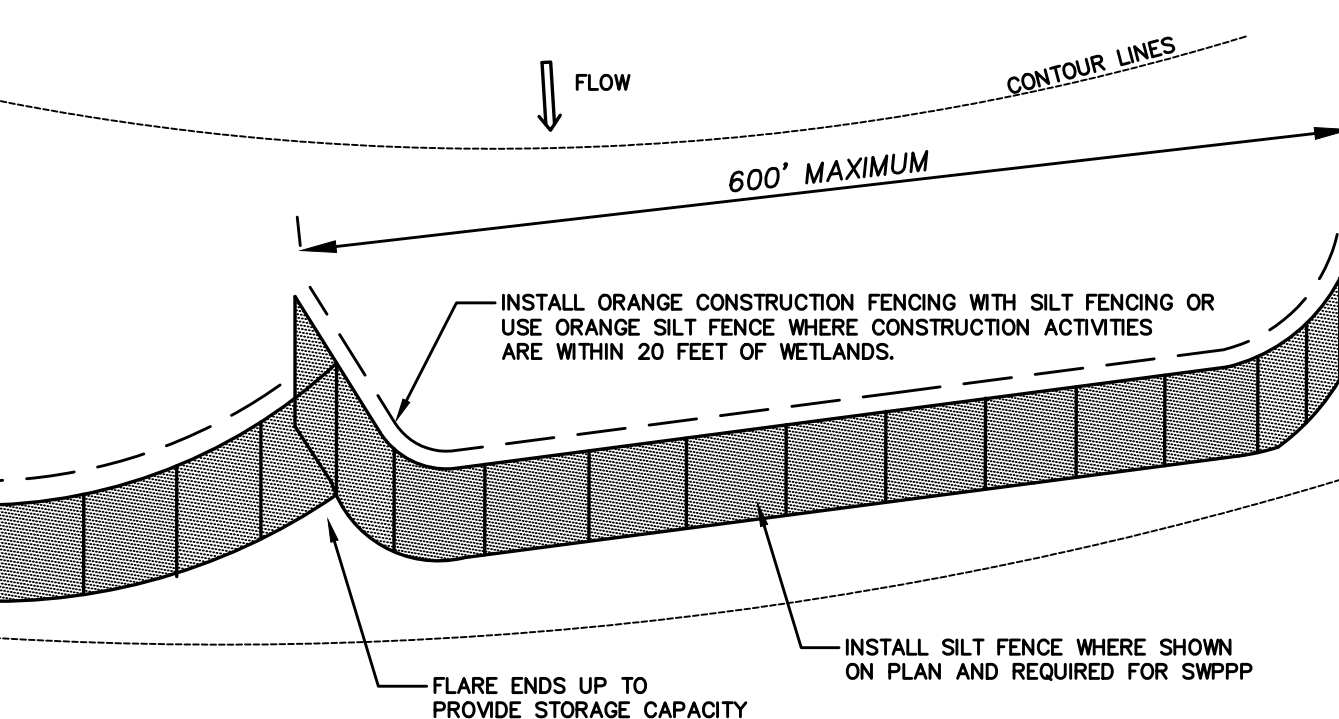
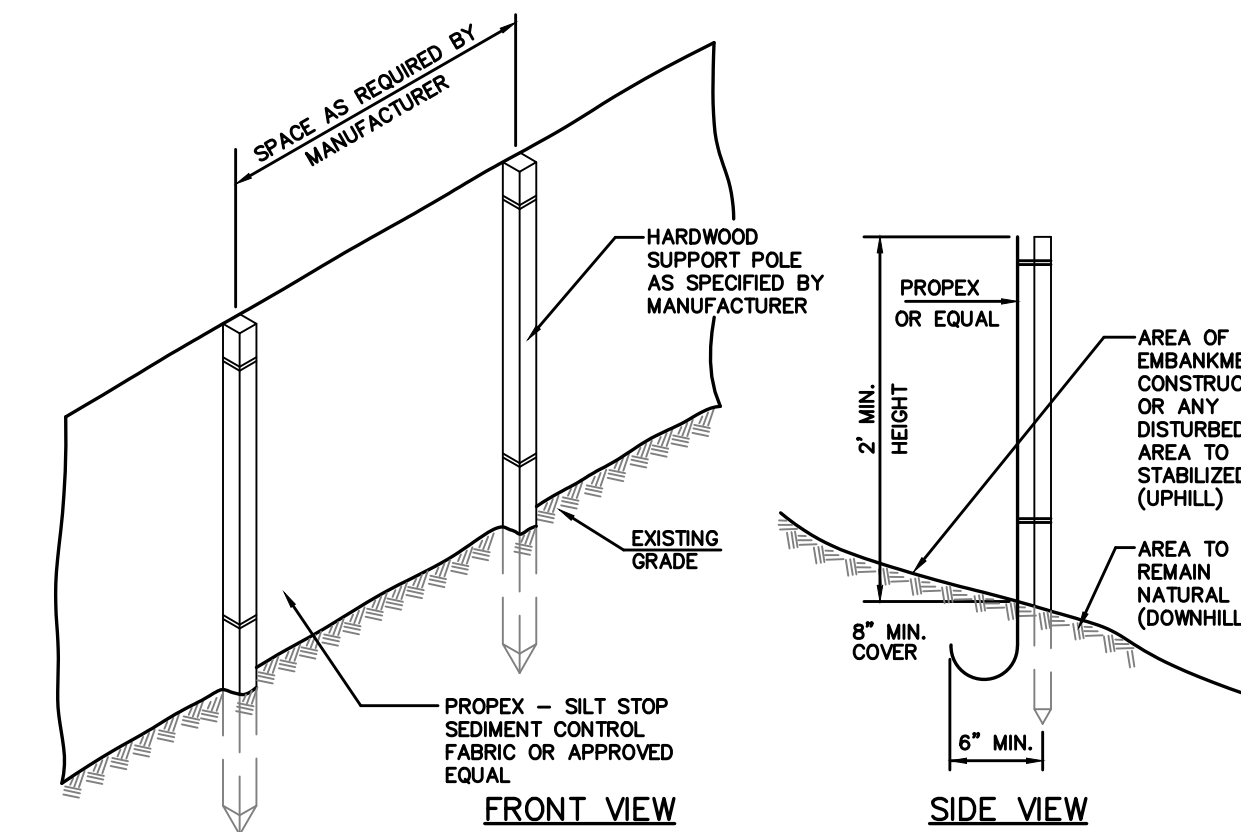

**SILT AND ORANGE CONSTRUCTION FENCE DETAIL N.T.S.**

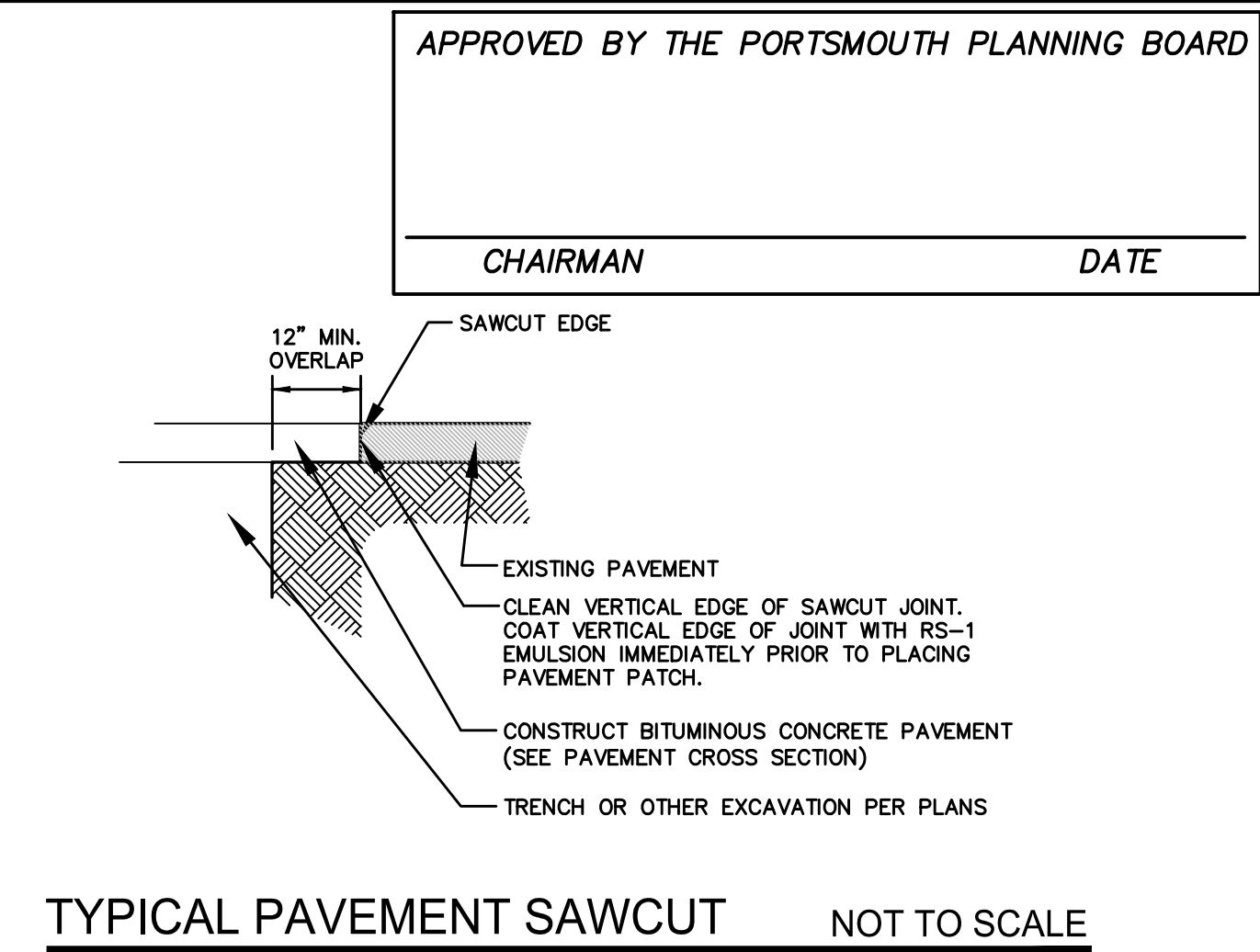

**TYPICAL PAVEMENT SAWCUT NOT TO SCALE**

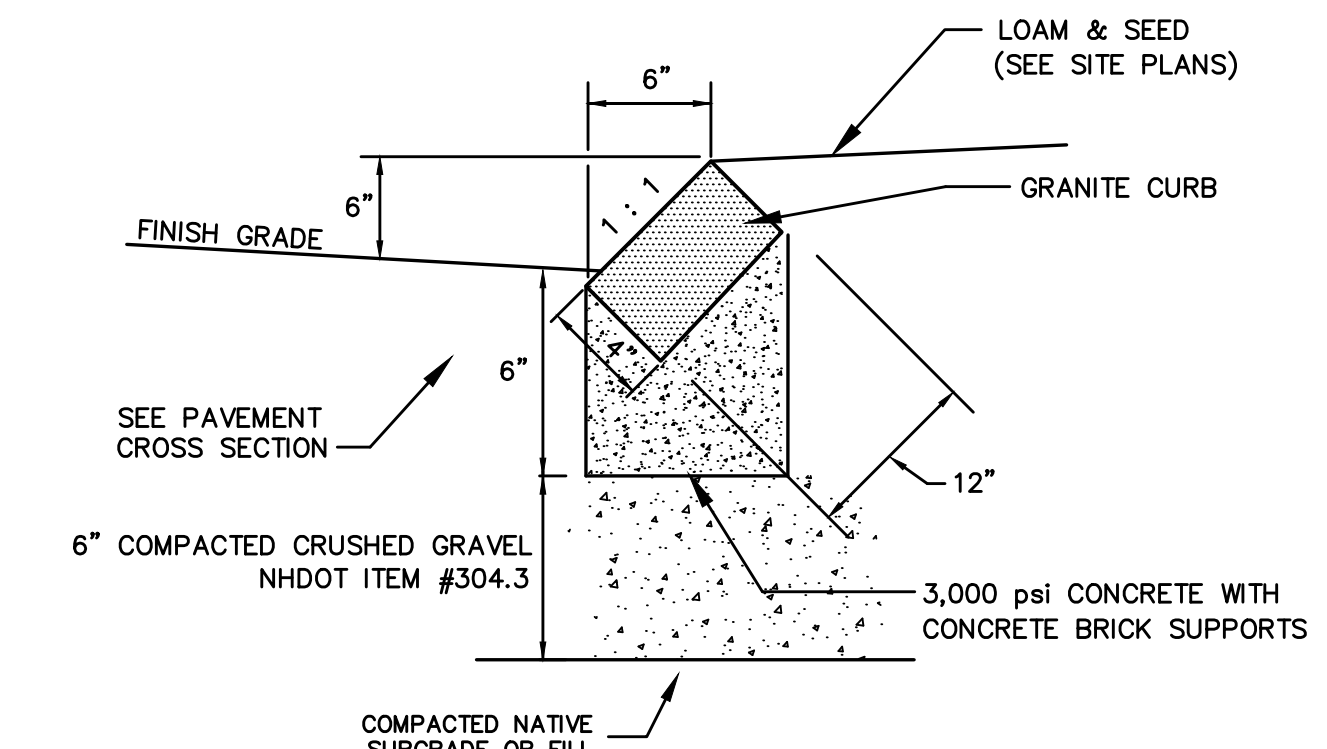

**NOTES**

1. SEE SITE PLAN FOR LIMITS OF CURBING
2. ADJOINING STONES OF STRAIGHT CURB LAID ON CURVES SHALL HAVE THE SAME OR APPROXIMATELY THE SAME LENGTH
3. MINIMUM LENGTH OF STRAIGHT CURB STONES = 18"
4. MAXIMUM LENGTH OF STRAIGHT CURB STONES = 8'
5. MAXIMUM LENGTH OF STRAIGHT CURB STONES LAID ON CURVES - SEE CHART

RADIUS FOR STONES WITH SQUARE JOINTS	MAXIMUM LENGTH
16'-28'	1'-6"
29'-41'	2'
42'-55'	3'
56'-68'	4'
69'-82'	5'
83'-96'	6'
97'-110'	7'
OVER 110'	8'

**SLOPED GRANITE CURB NOT TO SCALE**

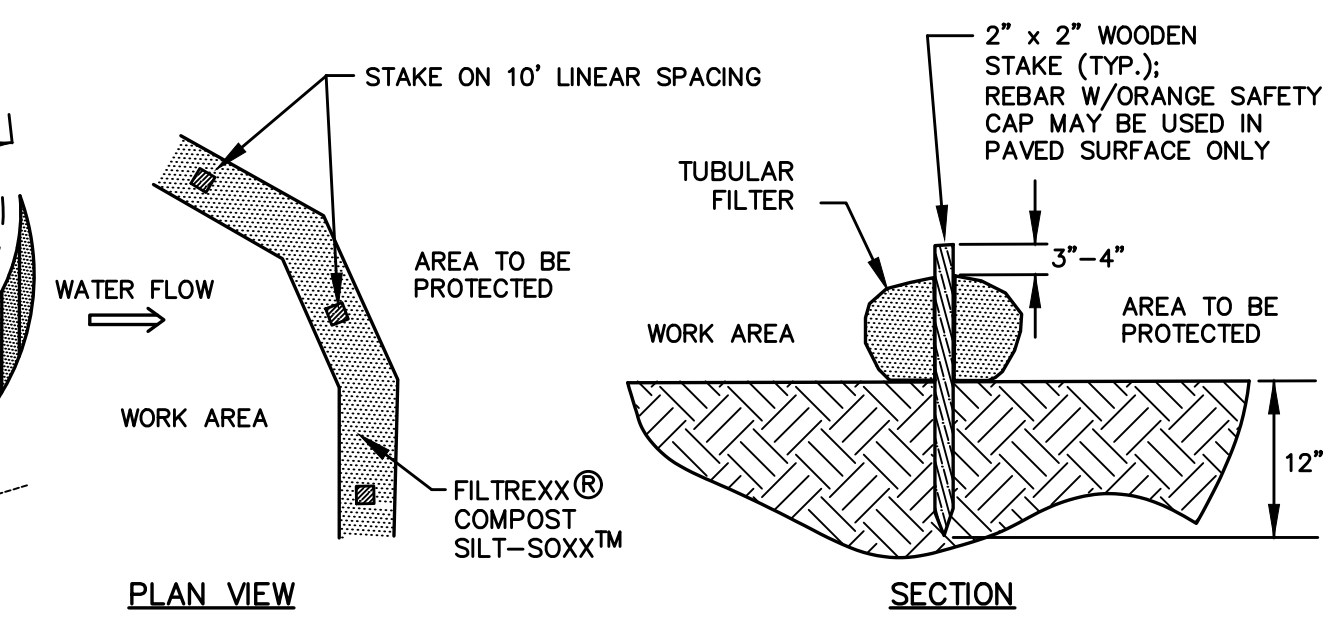

**NOTES:**

1. SILTSOXK OR APPROVED EQUAL SHALL BE USED FOR TUBULAR SEDIMENT BARRIERS.
2. ALL MATERIAL TO MEET MANUFACTURER'S SPECIFICATIONS.
3. COMPOST/SOIL/ROCK/SEED FILL MATERIAL SHALL BE ADJUSTED AS NECESSARY TO MEET THE REQUIREMENTS OF THE SPECIFIC APPLICATION.
4. ALL SEDIMENT TRAPPED BY BARRIER SHALL BE DISPOSED OF PROPERLY.

**TUBULAR SEDIMENT BARRIER DETAIL NOT TO SCALE**

APPROVED BY THE PORTSMOUTH PLANNING BOARD  
CHAIRMAN \_\_\_\_\_ DATE \_\_\_\_\_

**ALTUS ENGINEERING**  
133 Court Street Portsmouth, NH 03801  
(603) 433-2335 www.altus-eng.com

STATE OF NEW HAMPSHIRE  
ERIC D. WEINRIED  
No. 7634  
LICENSED PROFESSIONAL ENGINEER  
9/16/24

NOT FOR CONSTRUCTION

ISSUED FOR: TAC APPLICATION

ISSUE DATE: SEPTEMBER 16, 2024

REVISIONS  
NO. DESCRIPTION BY DATE  
0 INITIAL SUBMISSION EDW 09/16/24

DRAWN BY: JMG  
APPROVED BY: EDW  
DRAWING FILE: 5991-DETAILS.dwg

SCALE: NOT TO SCALE

OWNER:  
FRANCES E. MOUFLOUZE,  
TED W. ALEX &  
PATRICIA CAMERON, TRUSTEES  
THE FRANCES E. MOUFLOUZE  
REVOCABLE TRUST OF 2015  
104 LOCKE RD  
RYE, NH 03870

APPLICANT:  
GREEN & COMPANY  
11 LAFAYETTE ROAD  
P.O. BOX 1297  
NORTH HAMPTON, NH  
03862

PROJECT:  
PROPOSED 3 LOT  
SUBDIVISION  
TAX MAP 222, LOT 11  
550 SAGAMORE ROAD  
PORTSMOUTH, NH 03801

TITLE:  
CONSTRUCTION  
DETAILS

SHEET NUMBER:  
D-2

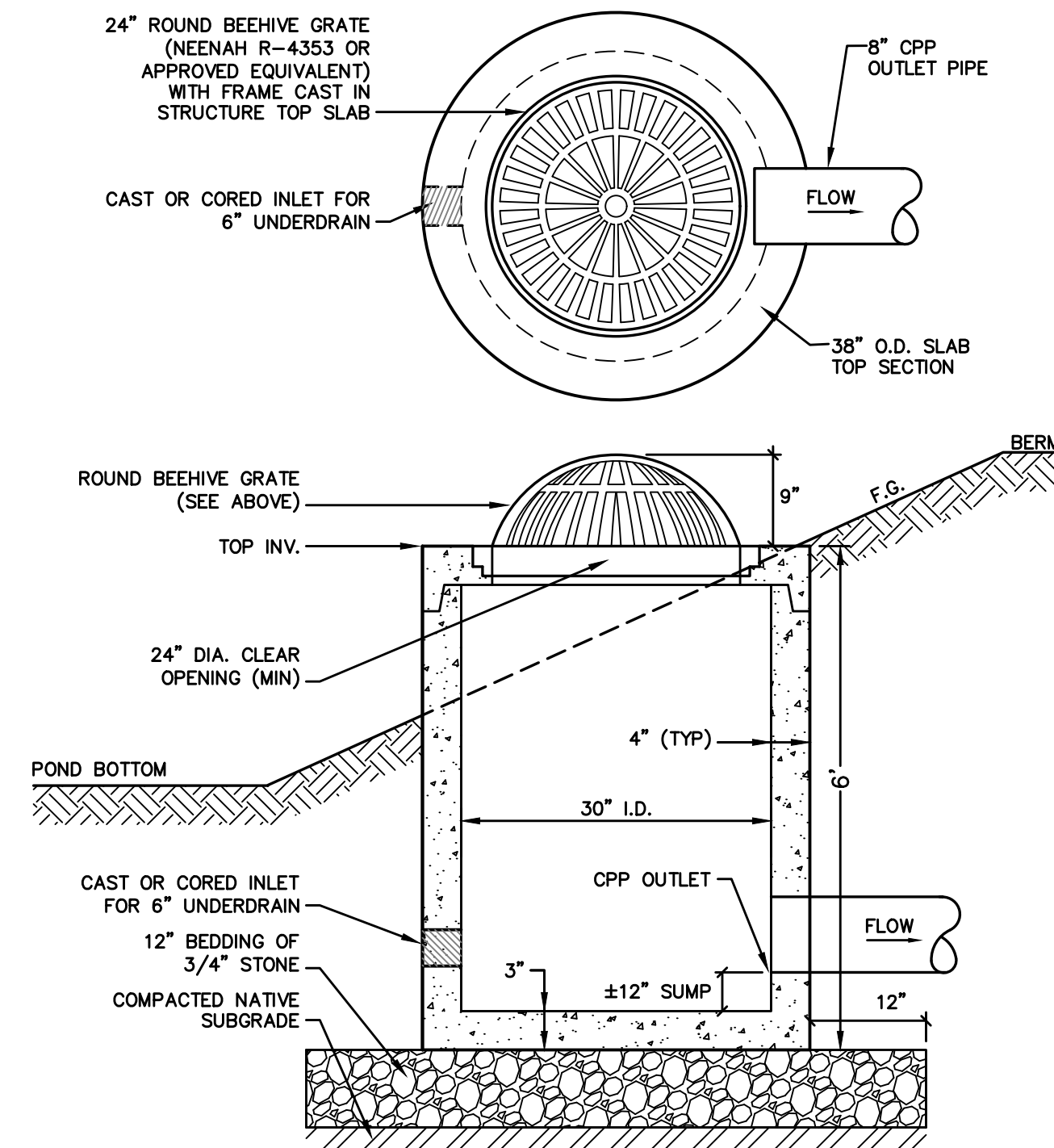

**CONSTRUCTION SPECIFICATIONS**

1. OUTLET STRUCTURE SHALL BE CONSTRUCTED ONSITE OR PRECAST TO EQUAL DIMENSIONS.
2. ALL JOINTS AND PIPE OPENINGS SHALL BE SEALED WATERTIGHT WITH MORTAR.
3. STRUCTURE IS TO BE BUILT TO WITHSTAND H20 LOADING.
4. SOIL UNDERLYING THE STRUCTURE'S GRAVEL BASE PAD AND THE PAD ITSELF ARE TO BE COMPACTED TO 95% MODIFIED PROCTOR.
5. ALL CONCRETE SHALL BE 4,000 PSI MINIMUM.

**OUTLET STRUCTURE NOT TO SCALE**

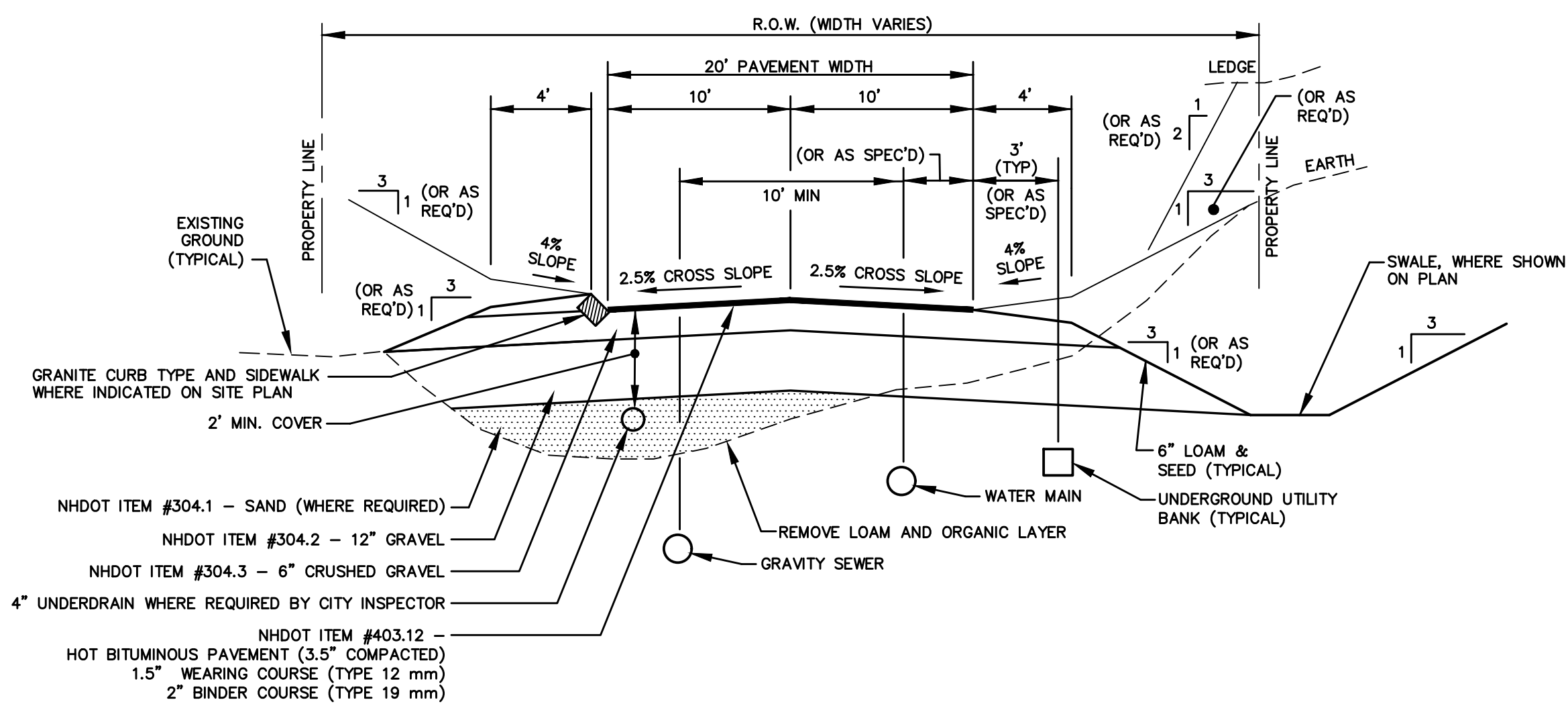

**NOTES**

1. EACH GRAVEL BASE COURSE TO BE CONSTRUCTED AT THE PAVEMENT CROSS SLOPE.
2. REMOVE LEDGE 18" BELOW LOWEST WORK BEING INSTALLED.
3. COMPACT ALL MATERIALS TO 95% STANDARD PROCTOR.
4. REMOVE ALL LOAM, CLAY, MUCK, ORGANIC, YIELDING OR OTHERWISE UNSTABLE MATERIAL TO A MINIMUM OF 20" BELOW THE FINISHED GRADE AND INSTALL COMPACTED SAND (OR GRAVEL BORROW APPROVED BY THE ENGINEER) TO SUBGRADE AS NECESSARY.
5. THE OVER-EXCAVATION OF UNSUITABLE MATERIAL BEYOND THAT SPECIFIED ABOVE, THE INSTALLATION OF UNDERDRAINAGE, AND/OR THE INSTALLATION OF GEOTEXTILE FABRIC SHALL BE PROVIDED UPON DETERMINATION OF THE DEPARTMENT OF PUBLIC WORKS.
6. SUBGRADE SHALL BE FREE OF VOIDS THAT ALLOW MOVEMENT AND/OR SETTLEMENT OF MATERIALS.
7. SUBGRADE SHALL BE PROOF-ROLLED WITH A FULLY LOADED DUMP TRUCK PRIOR TO PLACEMENT OF SELECT GRAVELS. PROOF-ROLLING SHALL BE WITNESSED AND APPROVED BY THE ENGINEER.

**TYPICAL ROADWAY CROSS SECTION NOT TO SCALE**

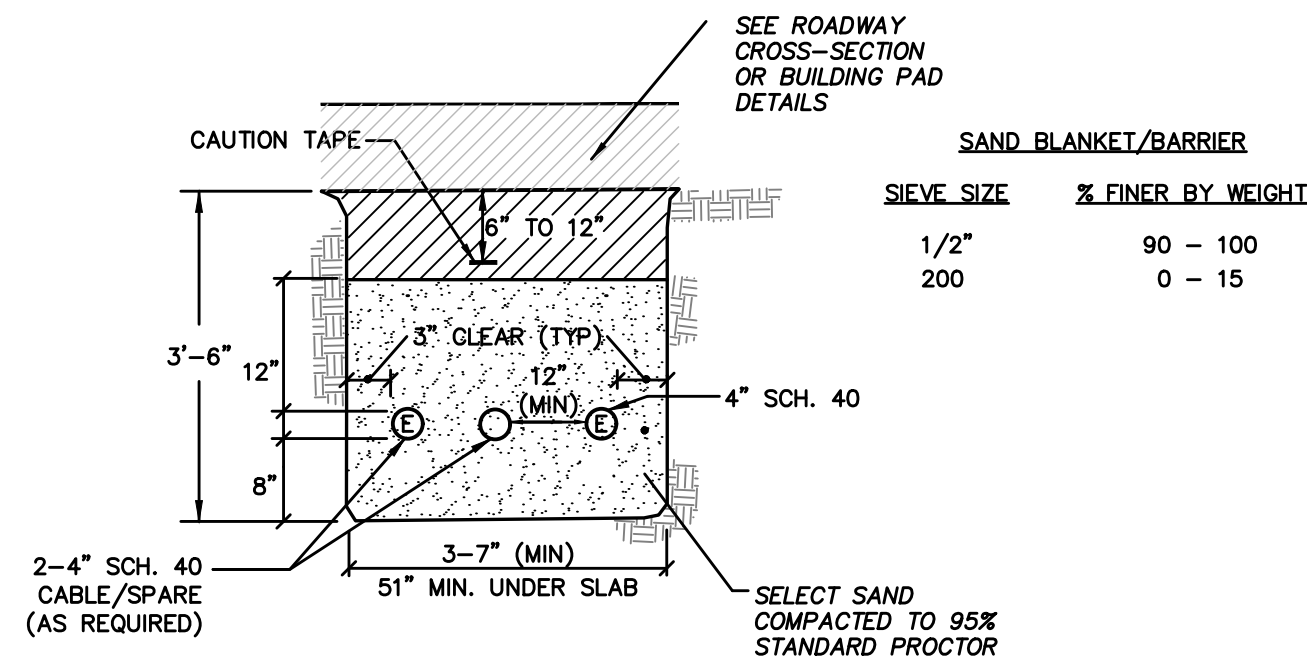

**NOTES**

1. ALL CONDUIT IS TO BE SCHEDULE 40 PVC, ELECTRICAL GRADE, GRAY IN COLOR AND INSTALLED PER THE MANUFACTURER'S RECOMMENDATIONS. A 10-FOOT HORIZONTAL SECTION OF RIGID GALVANIZED STEEL CONDUIT WILL BE REQUIRED AT EACH SWEEP, UNLESS IN THE OPINION OF THE SERVICE PROVIDER DESIGNER, THE SWEEP-PVC JOINT IS NOT SUBJECT TO FAILURE DURING PULLING OF THE CABLE. ALL JOINTS ARE TO BE WATERTIGHT.
2. ALL 90 DEGREE SWEEPS WILL BE MADE WITH RIGID GALVANIZED STEEL WITH A MINIMUM RADIUS OF 36 INCHES FOR PRIMARY CABLES AND 24 INCHES FOR SECONDARY CABLES.
3. BACKFILL MAY BE MADE WITH EXCAVATED MATERIAL OR COMPARABLE, UNLESS MATERIAL IS DEEMED UNSUITABLE BY SERVICE PROVIDER. BACKFILL SHALL BE FREE OF FROZEN LUMPS, ROCKS, DEBRIS, AND RUBBISH. ORGANIC MATERIAL SHALL NOT BE USED AS BACKFILL. BACKFILL SHALL BE IN 6-INCH LAYERS AND THOROUGHLY COMPACTED.
4. A SUITABLE PULLING STRING, CAPABLE OF 300 POUNDS OF PULL, MUST BE INSTALLED IN THE CONDUIT BEFORE SERVICE PROVIDER IS NOTIFIED TO INSTALL CABLE. THE STRING SHOULD BE BLOWN INTO THE CONDUIT AFTER THE RUN IS ASSEMBLED TO AVOID BONDING THE STRING TO THE CONDUIT. A MINIMUM OF TWENTY-FOUR (24") INCHES OF ROPE SLACK SHALL REMAIN AT THE END OF EACH DUCT. PULL ROPE SHALL BE INSTALLED IN ALL CONDUIT FOR FUTURE PULLS. PULL ROPE SHALL BE NYLON ROPE HAVING A MINIMUM TENSILE STRENGTH OF THREE HUNDRED (300#) LBS.
5. SERVICE PROVIDER SHALL BE GIVEN THE OPPORTUNITY TO INSPECT ALL CONDUIT PRIOR TO BACKFILL. THE CONTRACTOR IS RESPONSIBLE FOR ALL REPAIRS SHOULD SERVICE PROVIDER BE UNABLE TO INSTALL ITS CABLE IN A SUITABLE MANNER.
6. TYPICAL CONDUIT SIZES ARE 3-INCH FOR SINGLE PHASE PRIMARY AND SECONDARY VOLTAGE CABLES, 4-INCH FOR THREE PHASE SECONDARY, AND 5-INCH FOR THREE PHASE PRIMARY. HOWEVER, SERVICE PROVIDERS MAY REQUIRE DIFFERENT NUMBERS, TYPES AND SIZES OF CONDUIT THAN THOSE SHOWN HERE. THE CONTRACTOR SHALL BE RESPONSIBLE FOR VERIFYING ALL CONDUIT SIZES, TYPES AND NUMBERS WITH EACH SERVICE PROVIDER PRIOR TO ORDERING THEM.
7. ROUTING OF CONDUIT, LOCATION OF MANHOLES, TRANSFORMERS, CABINETS, HANDHOLES, ETC., SHALL BE DETERMINED BY SERVICE PROVIDER DESIGN PERSONNEL. THE CONTRACTOR SHALL COORDINATE WITH ALL SERVICE PROVIDERS PRIOR TO THE INSTALLATION OF ANY CONDUIT.
8. ALL CONDUIT INSTALLATIONS MUST CONFORM TO THE CURRENT EDITION OF THE NATIONAL ELECTRIC SAFETY CODE, STATE AND LOCAL CODES AND ORDINANCES, AND WHERE APPLICABLE, THE NATIONAL ELECTRIC CODE. WHERE REQUIRED BY UTILITY PROVIDER, CONDUIT SHALL BE SUPPORTED IN PLACE USING PIPE STANCHIONS PLACED EVERY FIVE (5') FEET ALONG THE CONDUIT RUN.
9. UNDER A BUILDING SLAB THE CONDUIT SHALL BE ENCASED IN 8" OF CONCRETE ON ALL SIDES.
10. ALL CONDUIT TERMINATIONS SHALL BE CAPPED TO PREVENT DEBRIS FROM ENTERING CONDUIT.

**ELECTRIC / COMMUNICATION TRENCH NOT TO SCALE**

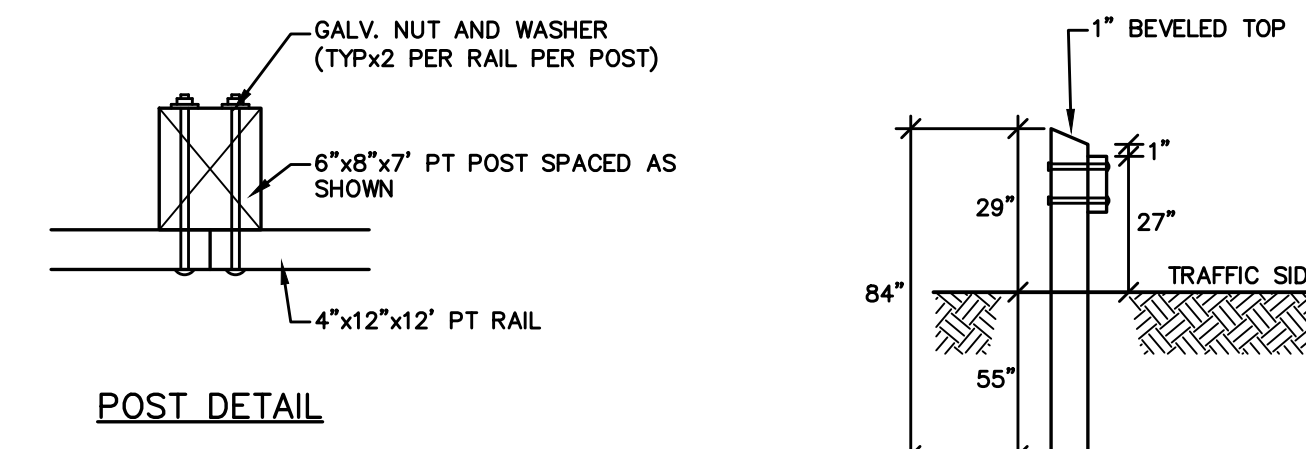
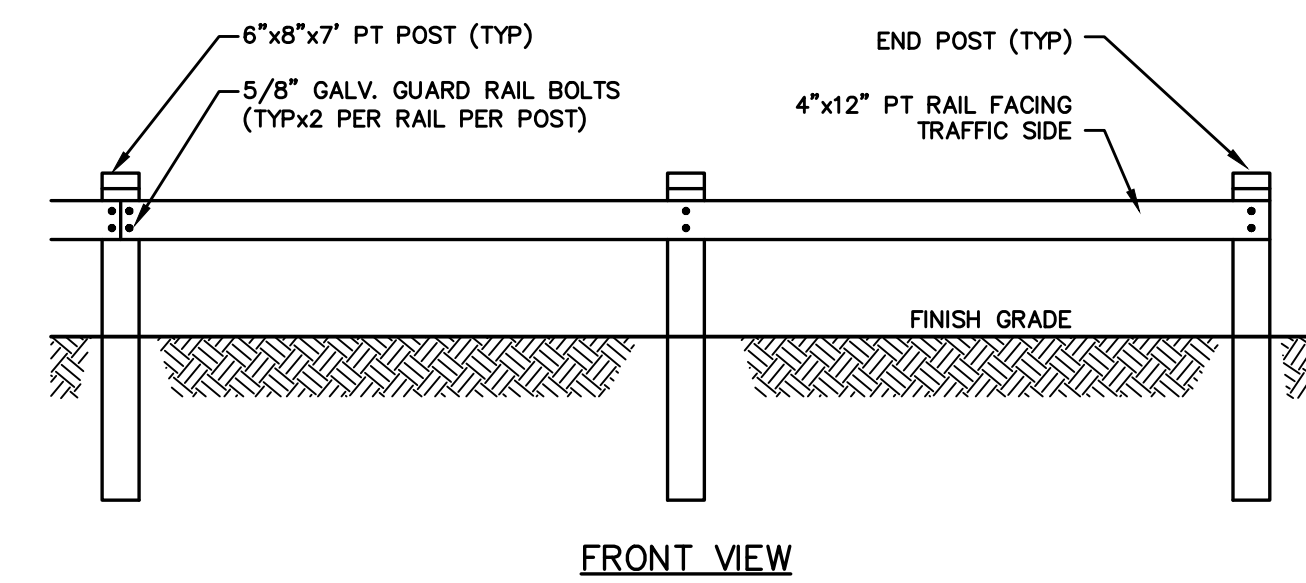
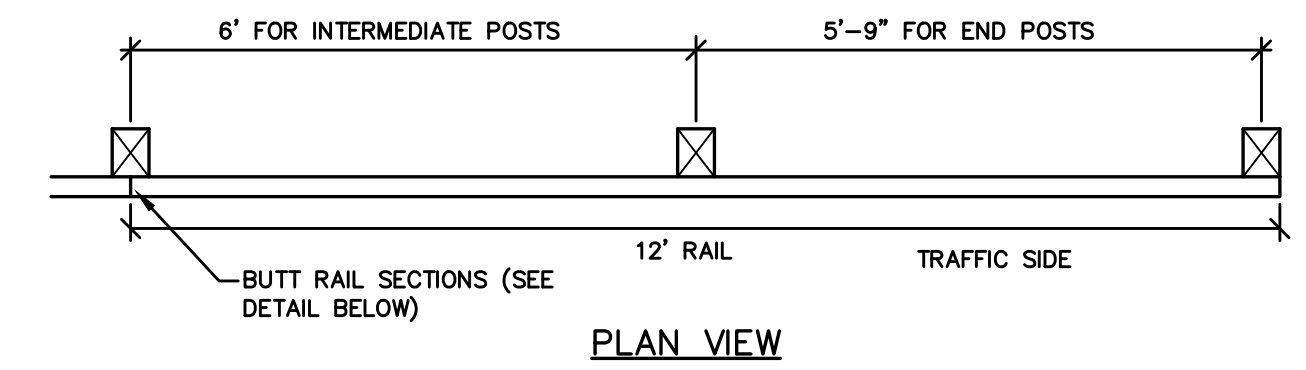

**NOTES**

1. ALL POST AND RAIL MATERIAL SHALL BE PRESSURE TREATED (PT). PT POSTS SHALL BE RATED FOR GROUND CONTACT.
2. BOLT LENGTH IS DETERMINED BY 8" POST AND RAIL THICKNESS PLUS 1 INCH FOR NUT AND WASHER.
3. ALL MATERIAL TO MEET OR EXCEED NHDOT SECTION 606 - GUARDRAIL.

**WOOD BEAM GUARDRAIL NOT TO SCALE**

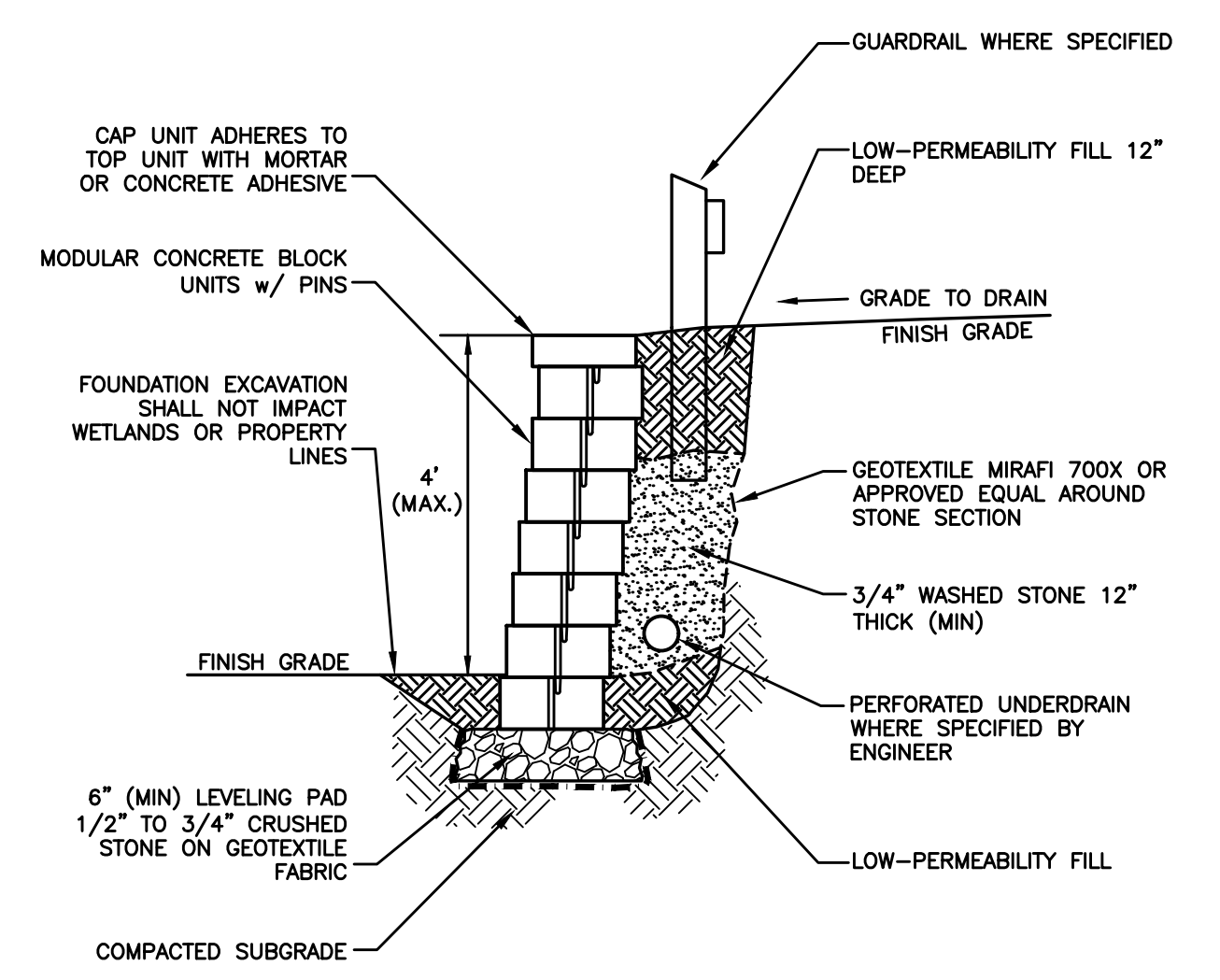

**NOTES:**

1. TYPICAL MODULAR BLOCK SHALL BE PRECAST CONCRETE MEASURING APPROXIMATELY 16"x12"x6". OTHER BLOCK SIZES MAY BE APPROVED BY THE ENGINEER UPON REQUEST. CAP UNITS SHALL BE PER THE STANDARDS OF THE SELECTED MANUFACTURER.
2. BLOCK MANUFACTURER SHALL BE APPROVED BY THE ENGINEER PRIOR TO INSTALLATION.
3. WALL SHALL BE INSTALLED PER THE REQUIREMENTS OF THE MANUFACTURER.
4. LOCKING PINS MAY OR MAY NOT BE REQUIRED BASED ON THE WALL MANUFACTURER APPROVED BY THE ENGINEER.
5. WALL SHALL BE EMBEDDED BELOW EXISTING GRADE THE DEPTH OF AT LEAST ONE BLOCK UNLESS OTHERWISE SPECIFIED BY THE WALL MANUFACTURER.
6. WALL BATTER SHALL BE PER THE MANUFACTURER'S SPECIFICATIONS.
7. BLOCK FINISH SHALL BE AT THE DISCRETION OF THE OWNER.
8. MODULAR BLOCK RETAINING WALL SHALL BE VERSA-LOK RETAINING WALL SYSTEMS (OR APPROVED EQUAL).
9. ANY WALL OVER 4' IN HEIGHT SHALL BE DESIGNED BY A NH REGISTERED STRUCTURAL ENGINEER WHO SHALL PROVIDE STAMPED DRAWINGS TO THE CONTRACTOR PRIOR TO CONSTRUCTION.

**MODULAR BLOCK RETAINING WALL NOT TO SCALE**

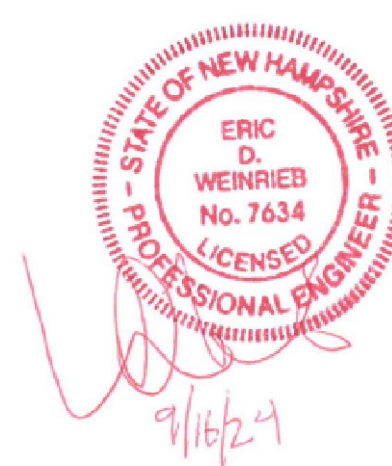

NOT FOR CONSTRUCTION

ISSUED FOR: TAC APPLICATION

ISSUE DATE: SEPTEMBER 16, 2024

REVISIONS

NO.	DESCRIPTION	BY	DATE
0	INITIAL SUBMISSION	EDW	09/16/24

DRAWN BY: JMG

APPROVED BY: EDW

DRAWING FILE: 5991-DETAILS.dwg

SCALE: NOT TO SCALE

OWNER:

FRANCES E. MOUFLOUZE,  
 TED W. ALEX &  
 PATRICIA CAMERON, TRUSTEES

THE FRANCES E. MOUFLOUZE  
 REVOCABLE TRUST OF 2015  
 104 LOCKE RD  
 RYE, NH 03870

APPLICANT:

GREEN & COMPANY  
 11 LAFAYETTE ROAD  
 P.O. BOX 1297  
 NORTH HAMPTON, NH  
 03862

PROJECT:

PROPOSED 3 LOT  
 SUBDIVISION  
 TAX MAP 222, LOT 11

550 SAGAMORE ROAD  
 PORTSMOUTH, NH 03801

TITLE:

CONSTRUCTION  
 DETAILS

SHEET NUMBER:

D-3

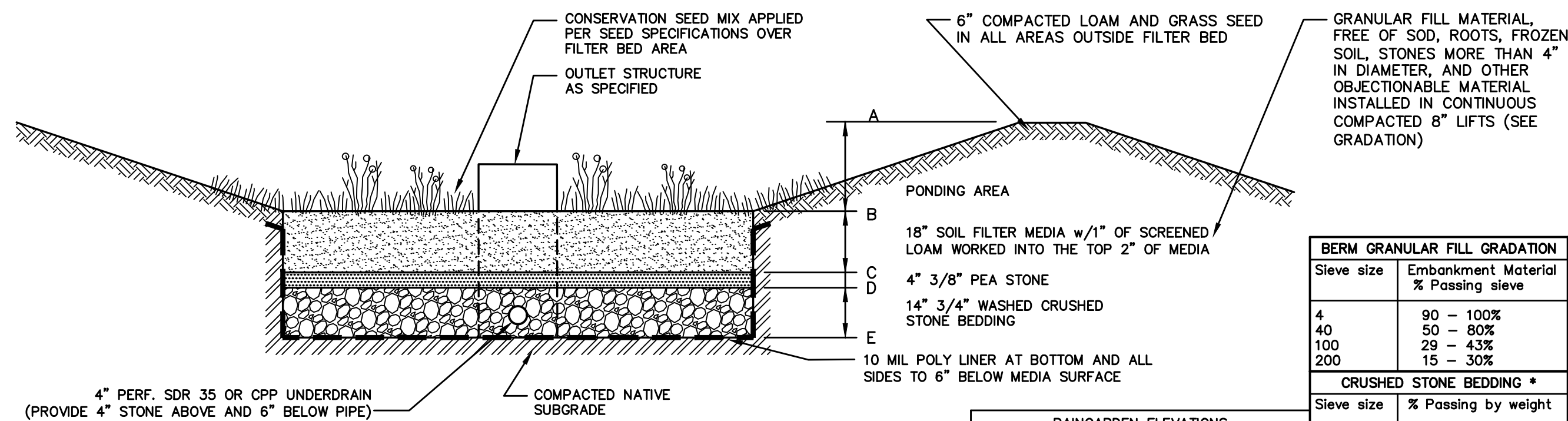

**NOTES**

- WHEN CONTRACTOR EXCAVATES BIORETENTION POND AREA TO SUBGRADE, DESIGN ENGINEER SHALL PERFORM SUBSURFACE EVALUATION PRIOR TO THE PLACEMENT OF ANY SELECT MATERIAL OR OTHER BACKFILL.
- SOIL FILTER MEDIA SHALL EITHER OPTION A OR OPTION B AT CONTRACTOR'S DISCRETION.
- DO NOT PLACE BIORETENTION POND INTO SERVICE UNTIL ITS SIDE SLOPES AND CONTRIBUTING AREAS HAVE BEEN STABILIZED.
- DO NOT DISCHARGE SEDIMENT-LADEN WATERS FROM CONSTRUCTION ACTIVITIES TO THE BIORETENTION POND DURING ANY STAGE OF CONSTRUCTION.
- DO NOT TRAFFIC EXPOSED SURFACES OF BIORETENTION POND WITH CONSTRUCTION EQUIPMENT. IF FEASIBLE, PERFORM EXCAVATION ACTIVITIES WITH EQUIPMENT POSITIONED OUTSIDE THE LIMITS OF THE BASIN.
- POND BERMS SHALL BE CONSTRUCTED IN ACCORDANCE WITH THE STORMWATER POND BERM DETAIL.

**MAINTENANCE REQUIREMENTS**

- SYSTEMS SHOULD BE INSPECTED AT LEAST TWICE ANNUALLY, AND FOLLOWING ANY RAINFALL EXCEEDING 2.5 INCHES IN A 24-HOUR PERIOD, WITH MAINTENANCE OR REHABILITATION CONDUCTED AS WARRANTED BY SUCH INSPECTION.
- PRETREATMENT MEASURES SHOULD BE INSPECTED AT LEAST TWICE ANNUALLY, AND CLEANED OF ACCUMULATED SEDIMENT AS WARRANTED BY INSPECTION, BUT NO LESS THAN ONCE ANNUALLY.
- AT LEAST ONCE ANNUALLY, SYSTEM SHOULD BE INSPECTED FOR DRAWDOWN TIME. IF BIORETENTION SYSTEM DOES NOT DRAIN WITHIN 72-HOURS FOLLOWING A RAINFALL EVENT, THEN A QUALIFIED PROFESSIONAL SHOULD ASSESS THE CONDITION OF THE FACILITY TO DETERMINE MEASURES REQUIRED TO RESTORE FILTRATION FUNCTION OR INFILTRATION FUNCTION (AS APPLICABLE), INCLUDING BUT NOT LIMITED TO REMOVAL OF ACCUMULATED SEDIMENTS OR RECONSTRUCTION OF THE FILTER MEDIA.
- VEGETATION SHOULD BE INSPECTED AT LEAST ANNUALLY, AND MAINTAINED IN HEALTHY CONDITION, INCLUDING WEED WHACKING, REMOVAL, AND REPLACEMENT OF DEAD OR DISEASED VEGETATION, AND REMOVAL OF INVASIVE SPECIES. BERM AREAS ARE TO BE MOWED TWICE ANNUALLY.

**DESIGN REFERENCES**

- UNH STORMWATER CENTER
- EPA (1999A)
- NEW HAMPSHIRE STORMWATER MANAGEMENT MANUAL, VOLUME 2, DECEMBER 2008 AS AMENDED.

RAINGARDEN ELEVATIONS			
	RG1	RG2	RG3
A	60.33'	62.00'	60.50'
B	58.00'	60.50'	58.67'
C	56.50'	59.00'	57.17'
D	56.17'	58.67'	56.84'
E	55.00'	57.50'	55.67'

FILTER MEDIA MIXTURES			
Component Material	Percent of Mixture by Volume	Gradation of material	
		Sieve No.	Percent by Weight Passing Standard Sieve
<b>Filter Media Option A</b>			
ASTM C-33 concrete sand	50 - 55%		
Loamy sand topsoil, with fines as indicated	20 - 30%	200	15 to 25%
Moderately fine shredded bark or wood fiber mulch, with fines as indicated	20 - 30%	200	< 5%
<b>Filter Media Option B</b>			
Moderately fine shredded bark or wood fiber mulch, with fines as indicated	20 - 30%	200	< 5%
Loamy coarse sand	70 - 80%	10	85 - 100%
		20	70 - 100%
		60	15 - 40%
		200	8 - 15%

**BIORETENTION POND / RAINGARDEN** NOT TO SCALE

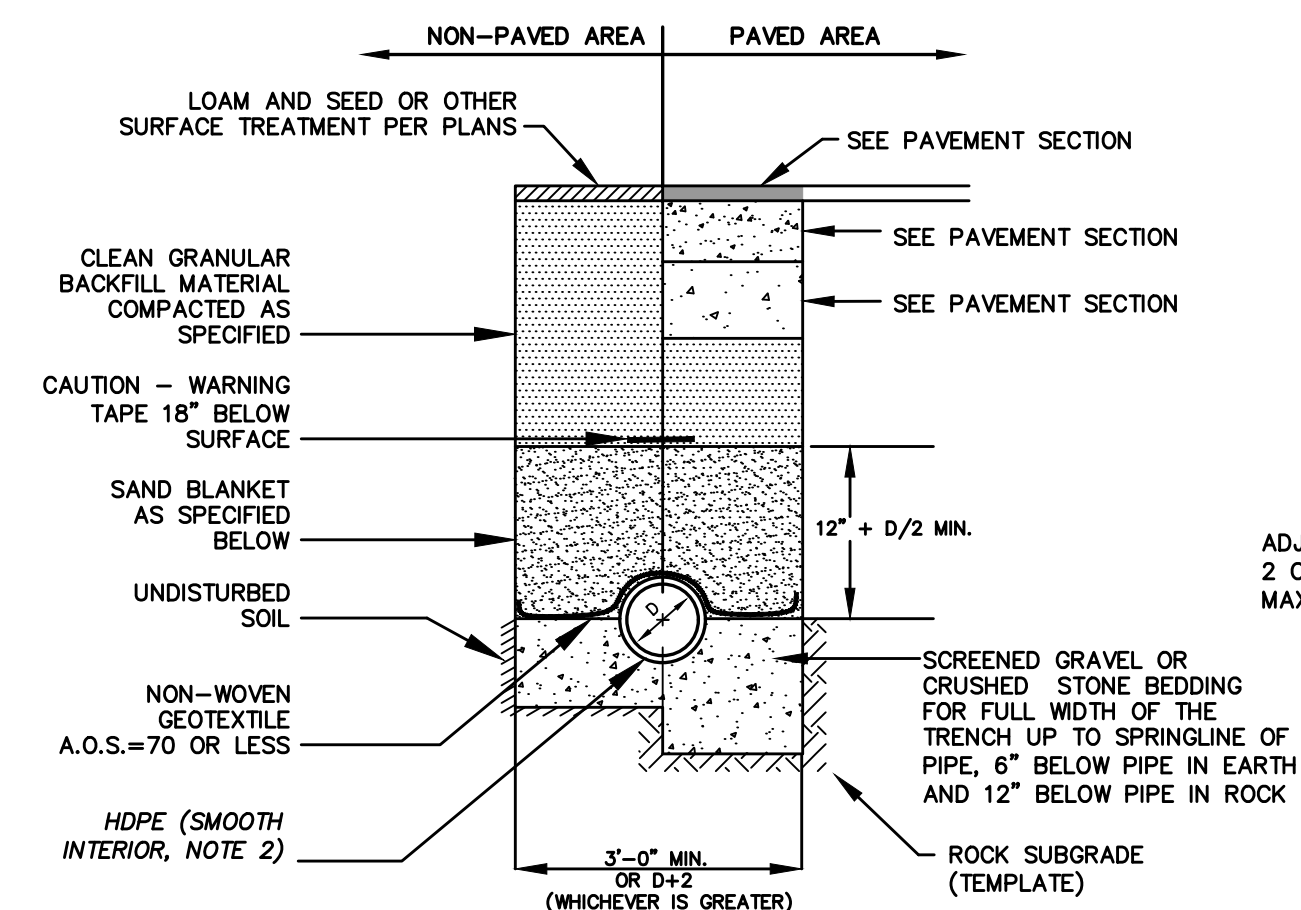

**NOTES**

- BACKFILL MATERIAL BELOW PAVED OR CONCRETE AREAS, BEDDING MATERIAL, AND SAND BLANKET SHALL BE COMPACTED TO NOT LESS THAN 95% OF AASHTO T 99, METHOD C. SUITABLE BACKFILL MATERIAL BELOW LOAM AREAS SHALL BE COMPACTED TO NOT LESS THAN 90% OF AASHTO T 99, METHOD C.
- ALL PIPE SHALL BE HDPE WITH SMOOTH INTERIOR AND CORRUGATED EXTERIOR, ADS TYPE N-12 OR APPROVED EQUAL.

SAND BLANKET/BARRIER		SCREENED GRAVEL OR CRUSHED STONE BEDDING*	
SIEVE SIZE	% FINER BY WEIGHT	SIEVE SIZE	% PASSING BY WEIGHT
1/2"	90 - 100	1"	100
200	0 - 15	3/4"	90 - 100
		3/8"	20 - 55
		#4	0 - 10
		#8	0 - 5

\* EQUIVALENT TO STANDARD STONE SIZE #67 - SECTION 703 OF NHDOT STANDARD SPECIFICATIONS

**STORM DRAIN TRENCH** NOT TO SCALE

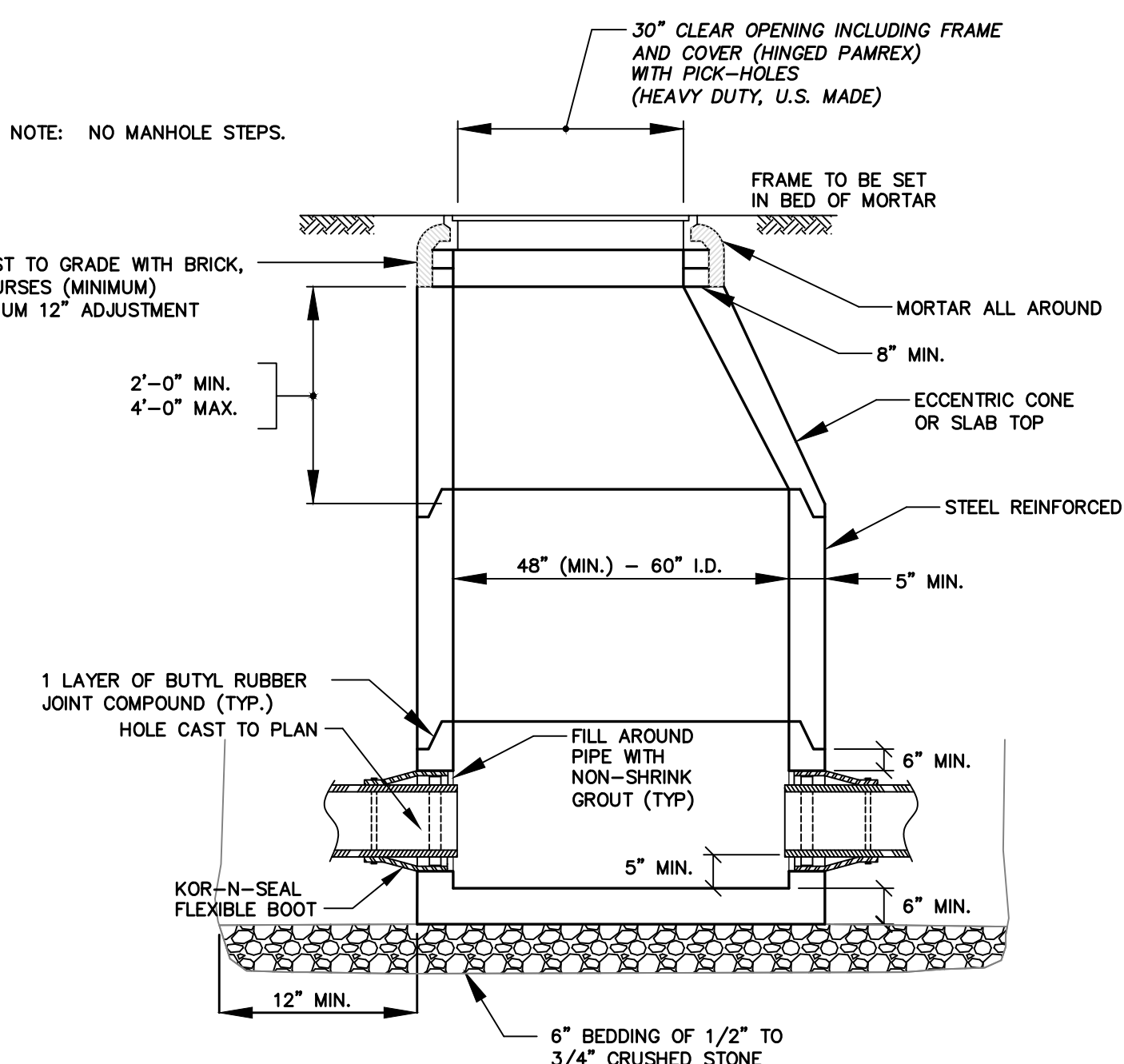

**DRAIN MANHOLE DETAIL** NOT TO SCALE

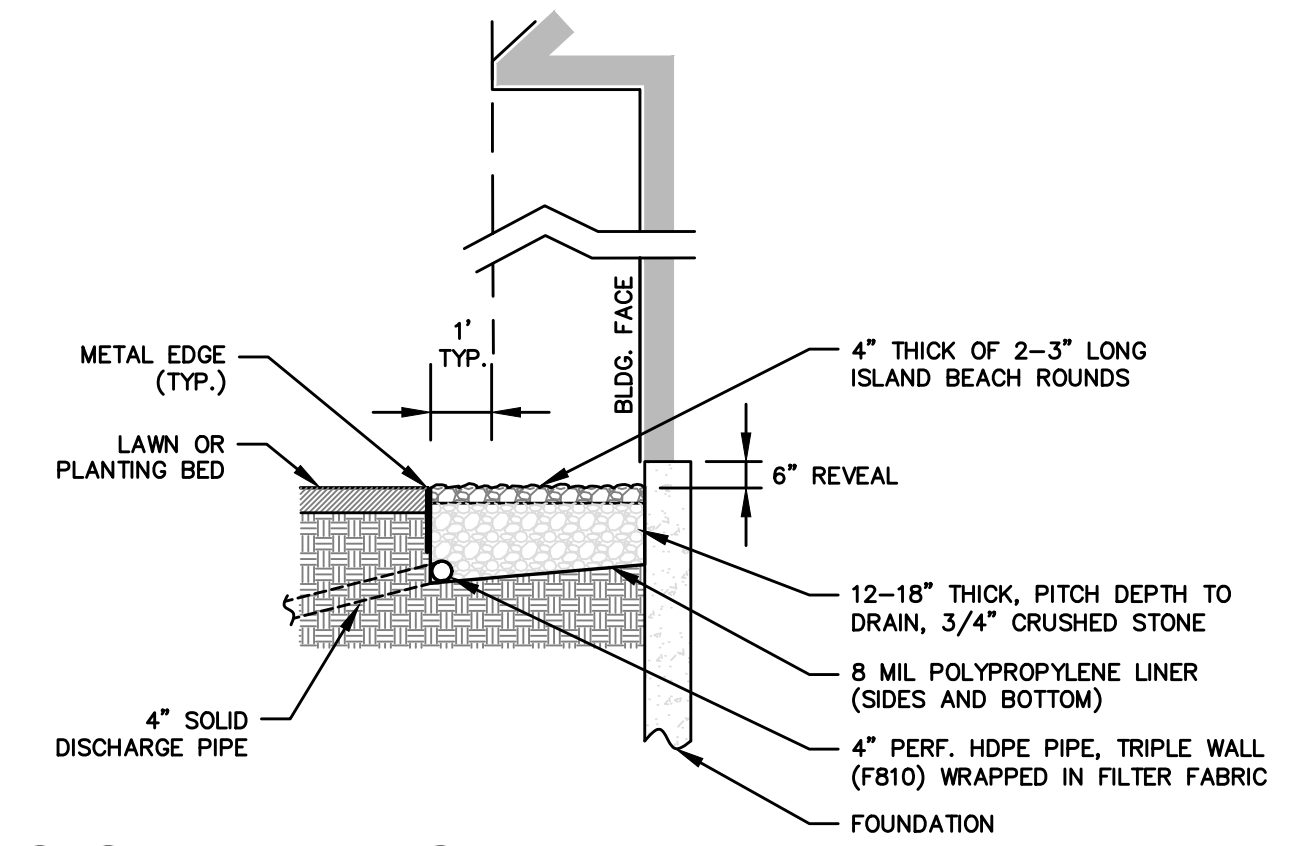

**STONE DRIP EDGE** NOT TO SCALE

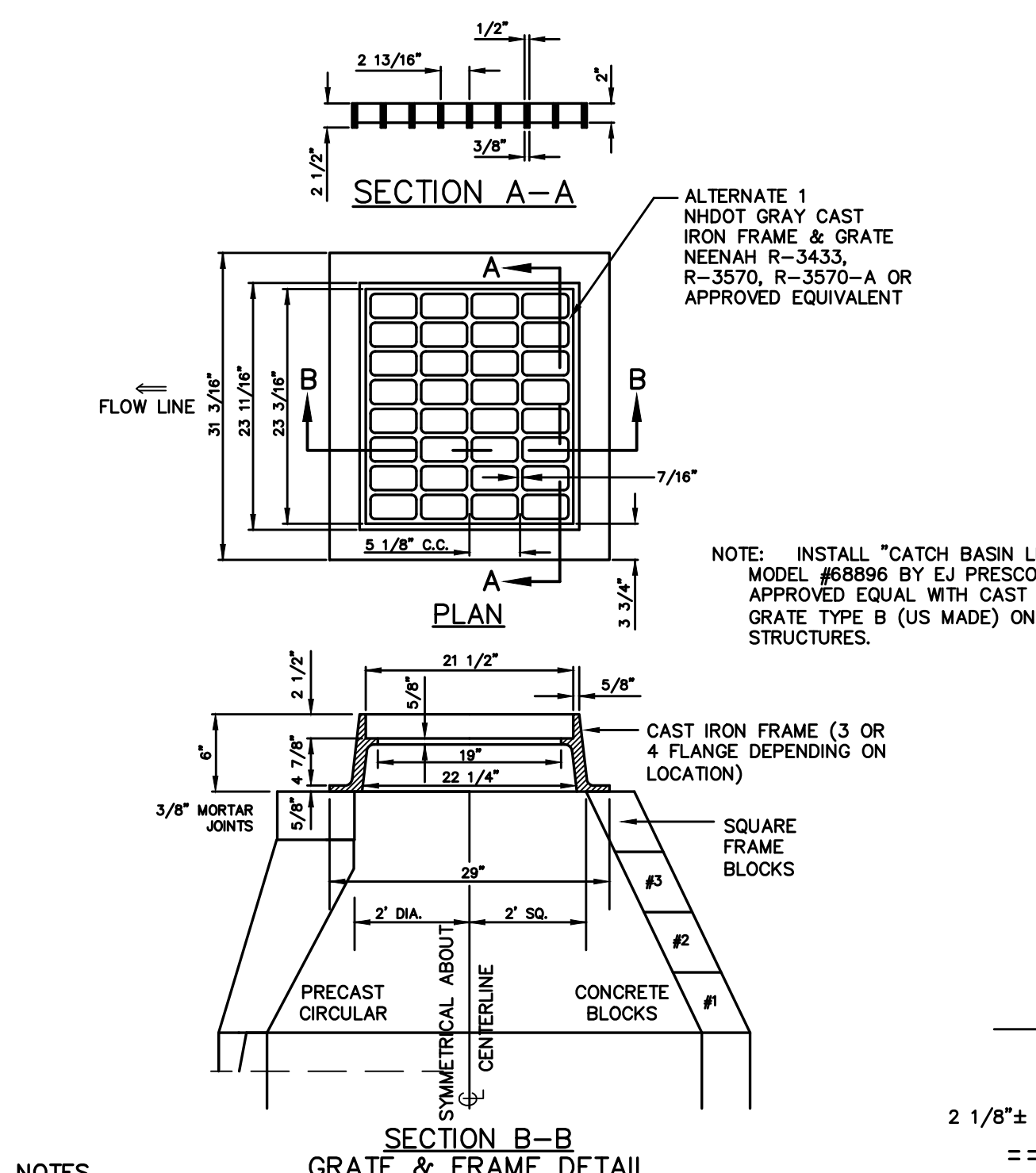

- NOTES**
- ALL SECTIONS SHALL BE CONCRETE CLASS AA (4000 PSI).
  - CIRCUMFERENTIAL REINFORCEMENT SHALL BE 0.12 SQ. IN. PER LINEAR FT. IN ALL SECTIONS AND SHALL BE PLACED IN THE CENTER THIRD OF THE WALL.
  - THE TONGUE OR GROOVE OF THE JOINT SHALL CONTAIN ONE LINE OF CIRCUMFERENTIAL REINFORCEMENT EQUAL TO 0.12 SQ. IN. PER LINEAR FT.
  - RISERS OF 1', 2', 3' & 4' CAN BE USED TO REACH DESIRED DEPTH.
  - THE STRUCTURES SHALL BE DESIGNED FOR H2O LOADING.
  - USE H2O LOADING SLAB TOP SECTION IN LIEU OF ECCENTRIC TOP WHERE PIPE INVERT IS WITHIN 4' OF FINISH GRADE.
  - FRAME AND GRATE DIMENSIONS ARE TYPICAL BUT MAY VARY BASED ON PRODUCT SELECTED OR EQUIVALENT APPROVED BY THE ENGINEER.

**DEEP SUMP CATCH BASIN** NOT TO SCALE

APPROVED BY THE PORTSMOUTH PLANNING BOARD

CHAIRMAN \_\_\_\_\_ DATE \_\_\_\_\_

**ALTUS ENGINEERING**

133 Court Street Portsmouth, NH 03801  
(603) 433-2335 www.altus-eng.com

STATE OF NEW HAMPSHIRE  
ERIC D. WEINRIED  
No. 7634  
LICENSED PROFESSIONAL ENGINEER  
9/16/24

NOT FOR CONSTRUCTION

ISSUED FOR: TAC APPLICATION

ISSUE DATE: SEPTEMBER 16, 2024

REVISIONS

NO.	DESCRIPTION	BY	DATE
0	INITIAL SUBMISSION	EDW	09/16/24

DRAWN BY: \_\_\_\_\_ JMG

APPROVED BY: \_\_\_\_\_ EDW

DRAWING FILE: 5991-DETAILS.dwg

SCALE: NOT TO SCALE

OWNER: FRANCES E. MOUFLOUZE, TED W. ALEX & PATRICIA CAMERON, TRUSTEES

THE FRANCES E. MOUFLOUZE REVOCABLE TRUST OF 2015  
104 LOCKE RD  
RYE, NH 03870

APPLICANT: GREEN & COMPANY  
11 LAFAYETTE ROAD  
P.O. BOX 1297  
NORTH HAMPTON, NH 03862

PROJECT: PROPOSED 3 LOT SUBDIVISION  
TAX MAP 222, LOT 11

550 SAGAMORE ROAD  
PORTSMOUTH, NH 03801

TITLE: CONSTRUCTION DETAILS

SHEET NUMBER: D-4

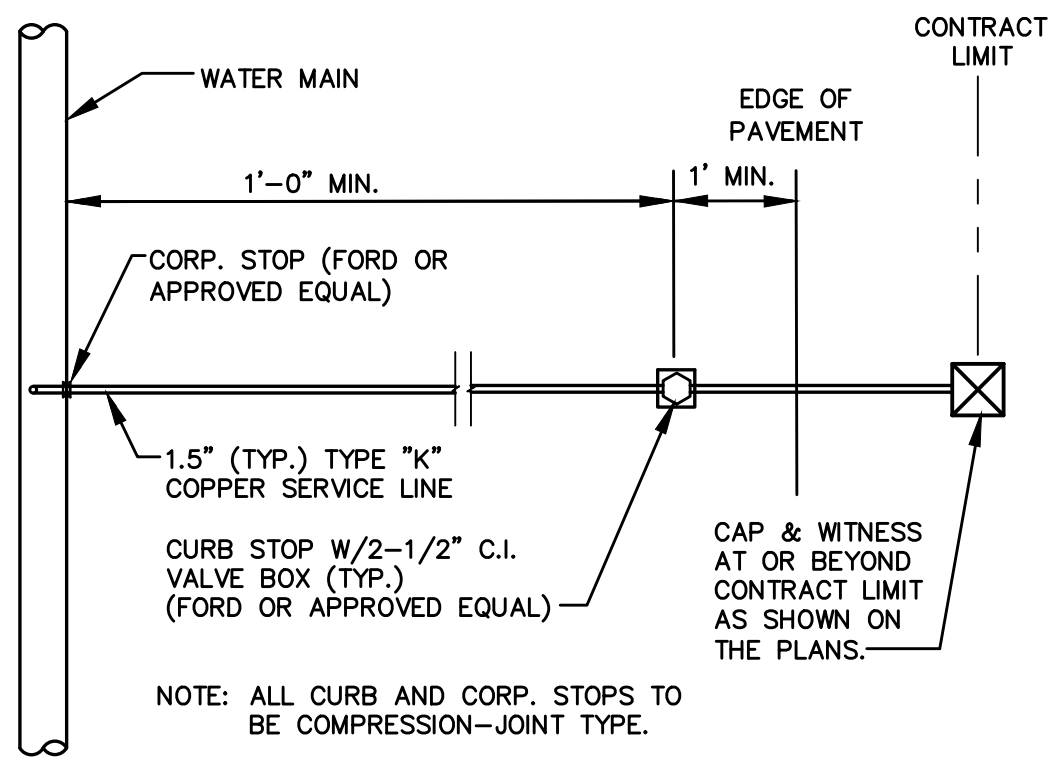

NOTE: ALL MATERIALS AND SPECIFICATIONS SHALL CONFORM TO CITY OF PORTSMOUTH WATER DEPARTMENT STANDARDS AND REQUIREMENTS. VERIFY PRIOR TO BEGINNING ANY CONSTRUCTION ACTIVITIES.

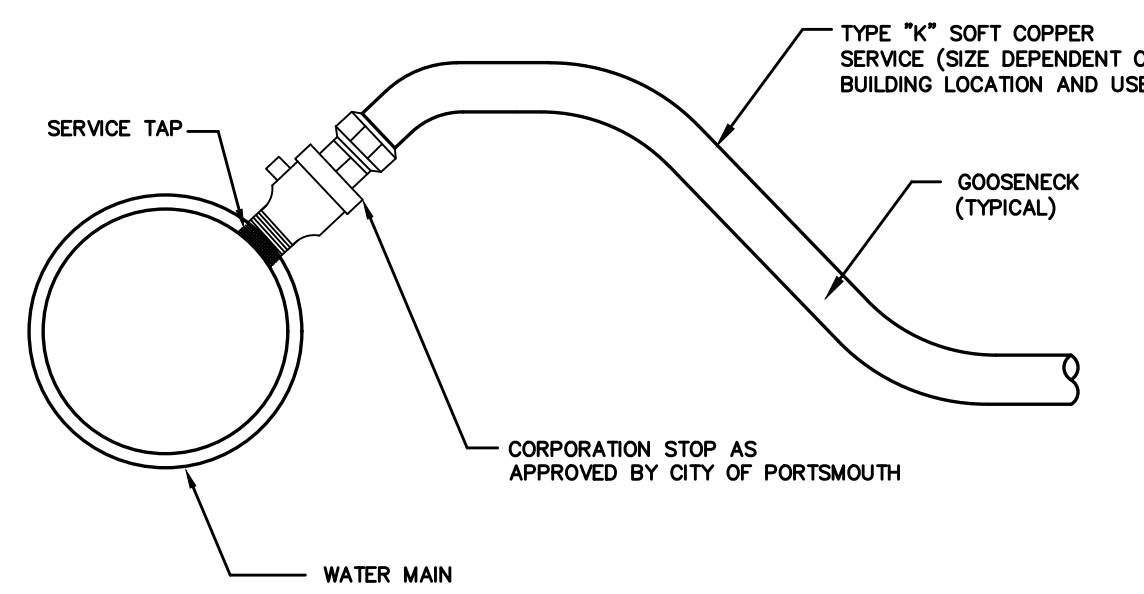

**WATER SERVICE CONNECTION** NOT TO SCALE

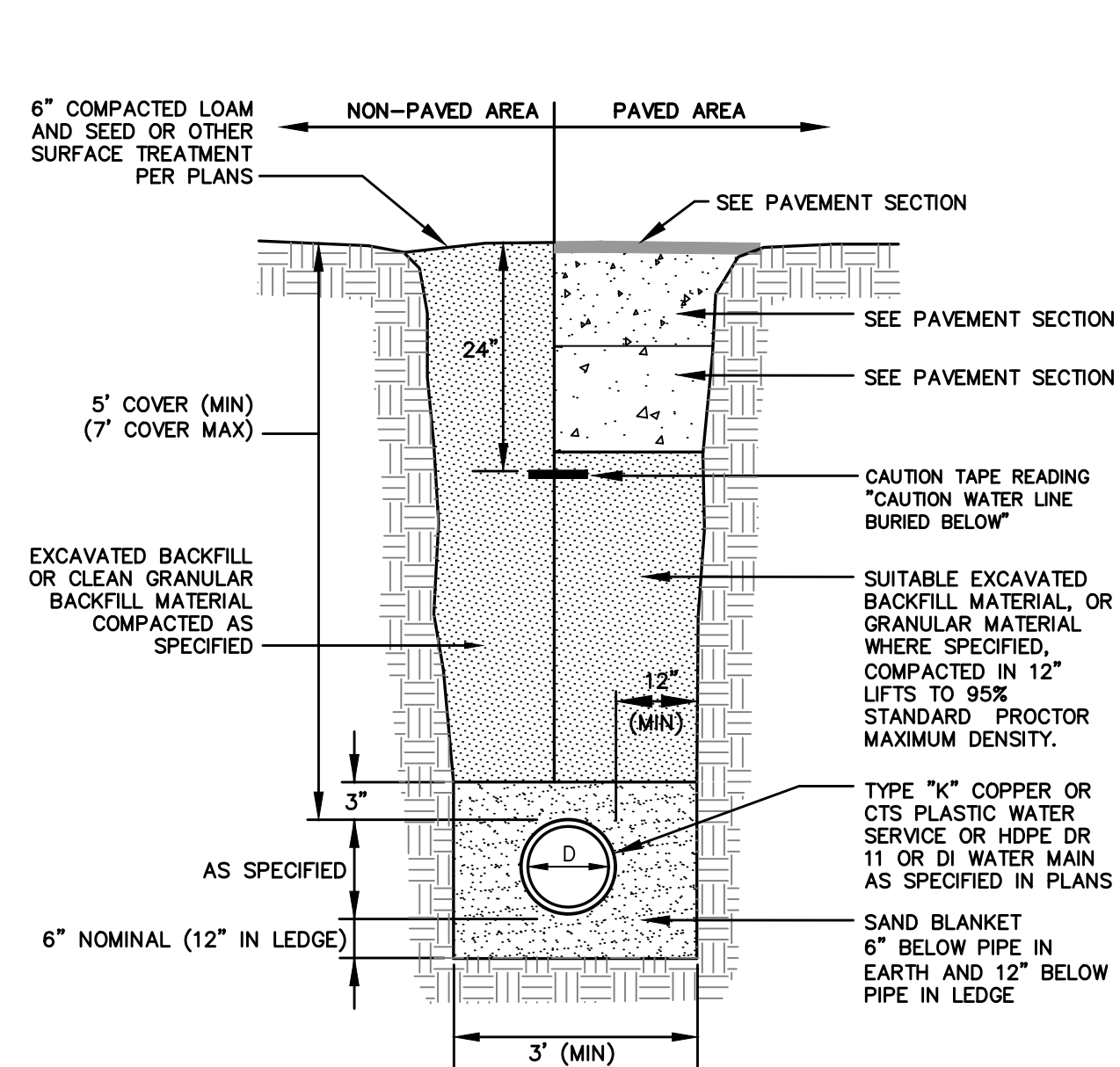

SAND BLANKET/BARRIER	
SIEVE SIZE	% FINER BY WEIGHT
1/2"	90 - 100
200	0 - 15

- NOTES:
- BACKFILL MATERIAL BELOW PAVED OR CONCRETE AREAS, BEDDING MATERIAL, AND SAND BLANKET SHALL BE COMPACTED TO NOT LESS THAN 95% OF AASHTO T 99, METHOD C. SUITABLE BACKFILL MATERIAL BELOW LOAM AREAS SHALL BE COMPACTED TO NOT LESS THAN 90% OF AASHTO T 99, METHOD C.
  - ALL TRENCHING AND BACKFILL SHALL CONFORM WITH THE STANDARDS OF EXETER DPW.

**WATER MAIN TRENCH** NOT TO SCALE

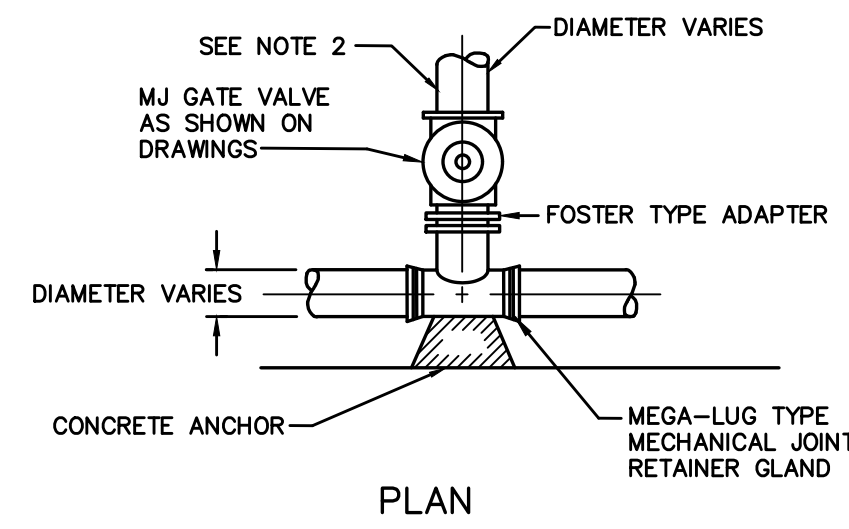

- NOTES:
- GATE VALVES SHALL OPEN RIGHT, PER CITY STANDARDS.
  - BRANCH PIPING SHALL BE MECHANICALLY RESTRAINED AS NOTED UNDER THRUST BLOCK DETAIL REQUIREMENTS.

**TEE & GATE VALVE ASSEMBLY** NOT TO SCALE

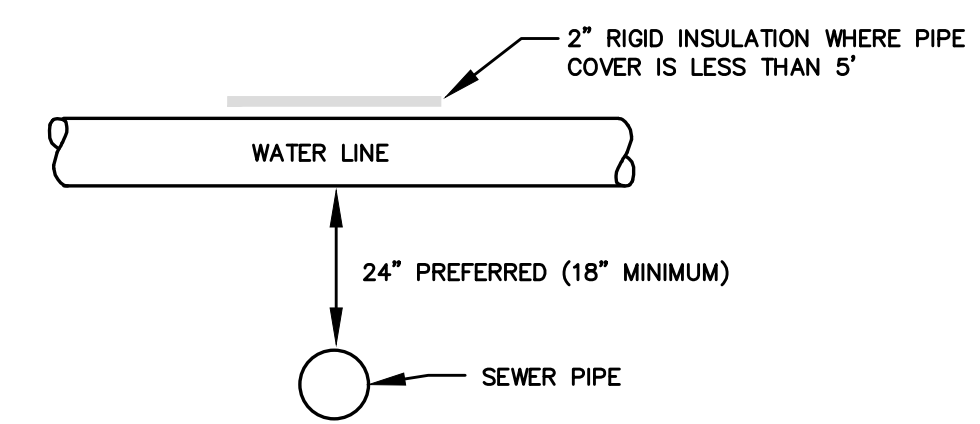

- NOTES:
- A MINIMUM HORIZONTAL DISTANCE OF 10 FEET SHALL BE MAINTAINED BETWEEN WATER AND SEWER MAINS. A MINIMUM VERTICAL DISTANCE WITH WATER ABOVE SEWER SHALL BE MAINTAINED.
  - SEWER PIPE JOINTS SHALL BE LOCATED A MINIMUM OF 6 FEET HORIZONTALLY FROM WATER MAIN.
  - IF THE REQUIRED CONFIGURATION CANNOT BE MET, THE SEWER MAIN SHALL BE CONSTRUCTED TO MEET THE NHDES REQUIREMENTS FOR FORCE MAIN CONSTRUCTION.

**WATER MAIN / SEWER CROSSING** NOT TO SCALE

APPROVED BY THE PORTSMOUTH PLANNING BOARD

CHAIRMAN \_\_\_\_\_ DATE \_\_\_\_\_

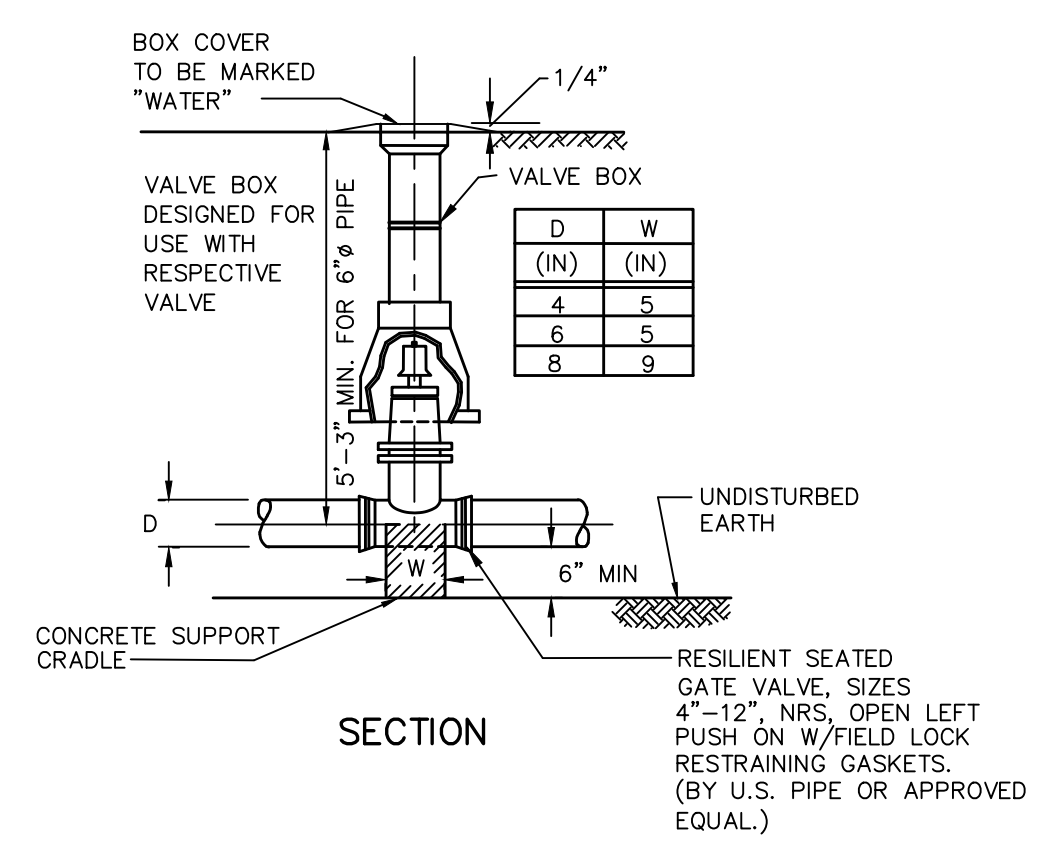

**WATER VALVE DETAIL** NOT TO SCALE

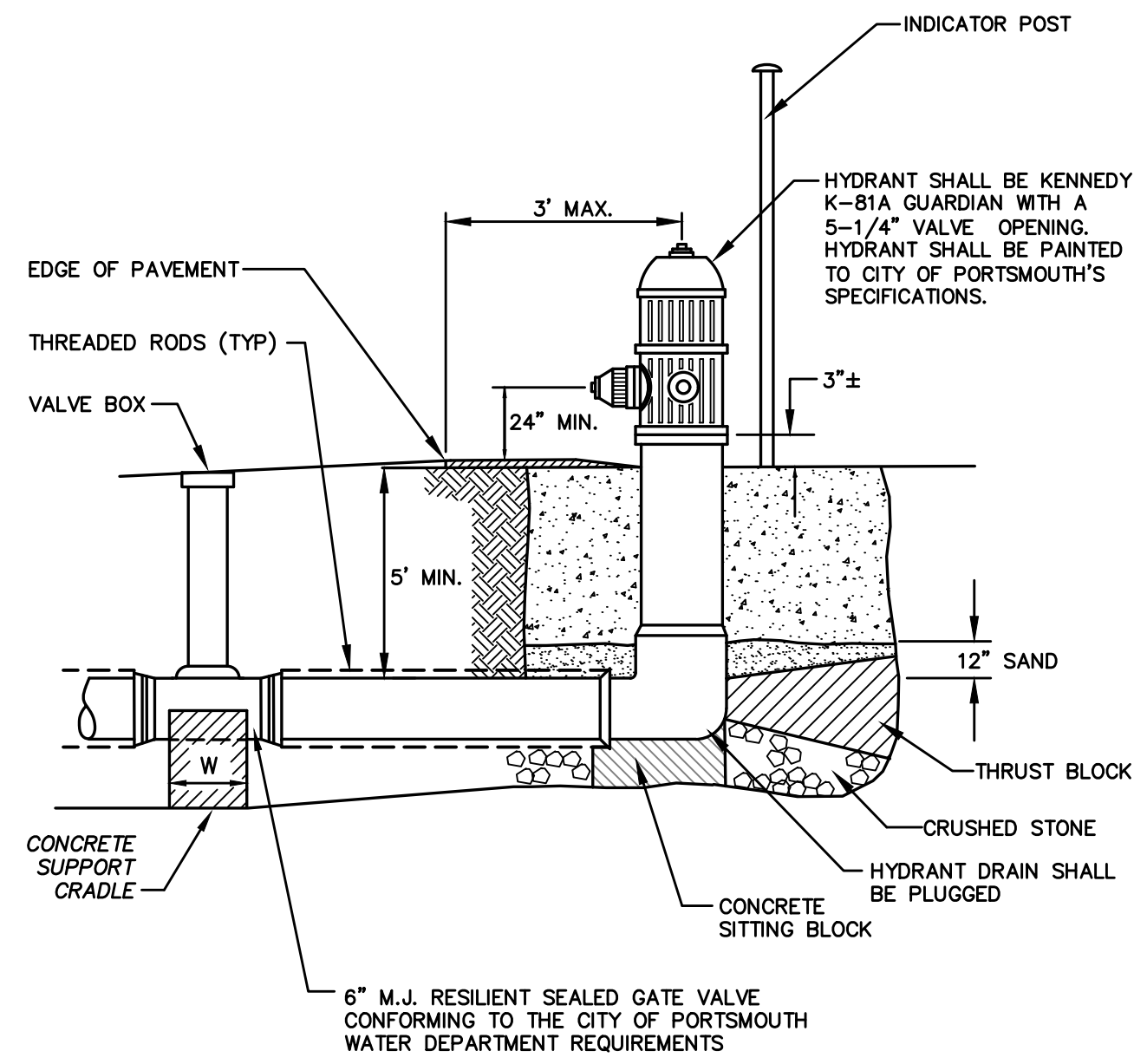

D (IN)	W (IN)
4	5
6	5
8	9

- NOTES:
- HYDRANT INSTALLATION AND OPERATION TO CONFORM TO REGULATIONS OF THE CITY OF PORTSMOUTH WATER & FIRE DEPARTMENTS.
  - GATE VALVES & HYDRANTS TO OPEN RIGHT (CLOCKWISE).

**FIRE HYDRANT** NOT TO SCALE

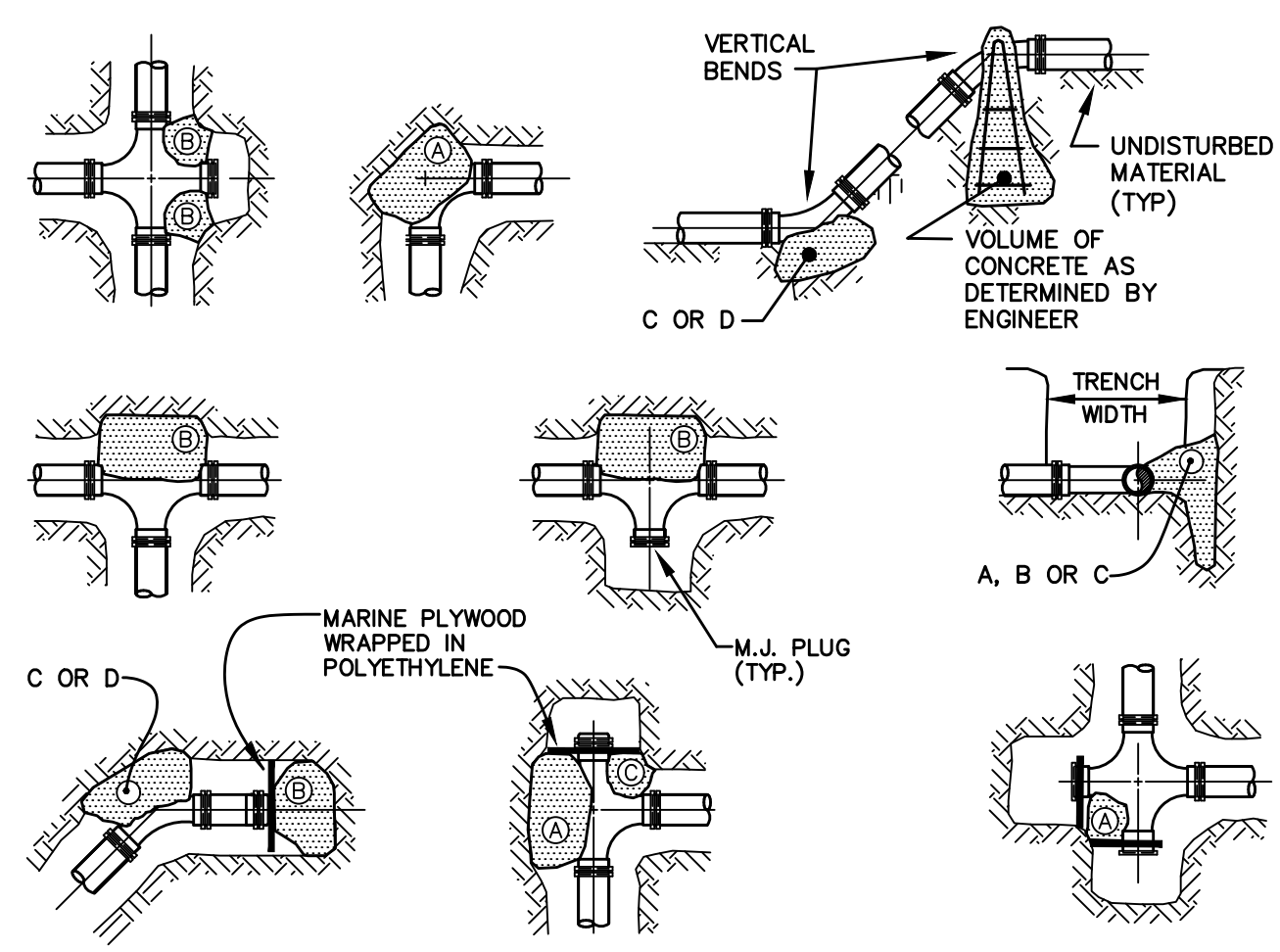

REACTION TYPE	PIPE SIZE				
	4"	6"	8"	10"	12"
A 90°	0.89	2.19	3.82	11.14	17.24
B 180°	0.65	1.55	2.78	8.38	12.00
C 45°	0.48	1.19	2.12	6.02	9.32
D 22-1/2°	0.25	0.60	1.06	3.08	4.74
E 11-1/4°	0.13	0.30	0.54	1.54	2.38

- NOTES:
- POUR THRUST BLOCKS AGAINST UNDISTURBED MATERIAL. WHERE TRENCH WALL HAS BEEN DISTURBED, EXCAVATE LOOSE MATERIAL AND EXTEND THRUST BLOCK TO UNDISTURBED MATERIAL.
  - NO JOINTS SHALL BE COVERED WITH CONCRETE. POLYETHYLENE (6 MIL) SHALL BE PLACED AROUND FITTINGS PRIOR TO CONCRETE PLACEMENT.
  - ON BENDS AND TEES, EXTEND THRUST BLOCKS FULL LENGTH OF FITTING.
  - PLACE BOARD IN FRONT OF ALL PLUGS BEFORE POURING THRUST BLOCKS. WHERE M.J. PIPE IS USED, M.J. PLUG WITH RETAINER GLAND MAY BE SUBSTITUTED FOR END BLOCKINGS.
  - PRECAST THRUST BLOCKS MAY BE SUBSTITUTED WITH THE APPROVAL OF THE ENGINEER AND LOCAL WATER DEPARTMENT.

**THRUST BLOCKING** NOT TO SCALE

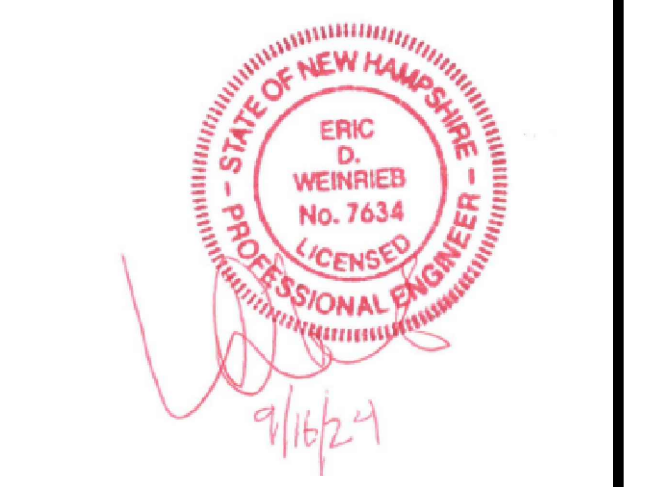

NOT FOR CONSTRUCTION

ISSUED FOR: TAC APPLICATION

ISSUE DATE: SEPTEMBER 16, 2024

REVISIONS

NO.	DESCRIPTION	BY	DATE
0	INITIAL SUBMISSION	EDW	09/16/24

DRAWN BY: \_\_\_\_\_ JMG  
APPROVED BY: \_\_\_\_\_ EDW  
DRAWING FILE: 5991-DETAILS.dwg

SCALE: NOT TO SCALE

OWNER:  
FRANCES E. MOUFLOUZE,  
TED W. ALEX &  
PATRICIA CAMERON, TRUSTEES

THE FRANCES E. MOUFLOUZE  
REVOCABLE TRUST OF 2015  
104 LOCKE RD  
RYE, NH 03870

APPLICANT:  
GREEN & COMPANY  
11 LAFAYETTE ROAD  
P.O. BOX 1297  
NORTH HAMPTON, NH  
03862

PROJECT:  
PROPOSED 3 LOT  
SUBDIVISION  
TAX MAP 222, LOT 11

550 SAGAMORE ROAD  
PORTSMOUTH, NH 03801

TITLE:  
CONSTRUCTION  
DETAILS

SHEET NUMBER:  
D-5



APPROVED BY THE PORTSMOUTH PLANNING BOARD

CHAIRMAN \_\_\_\_\_ DATE \_\_\_\_\_

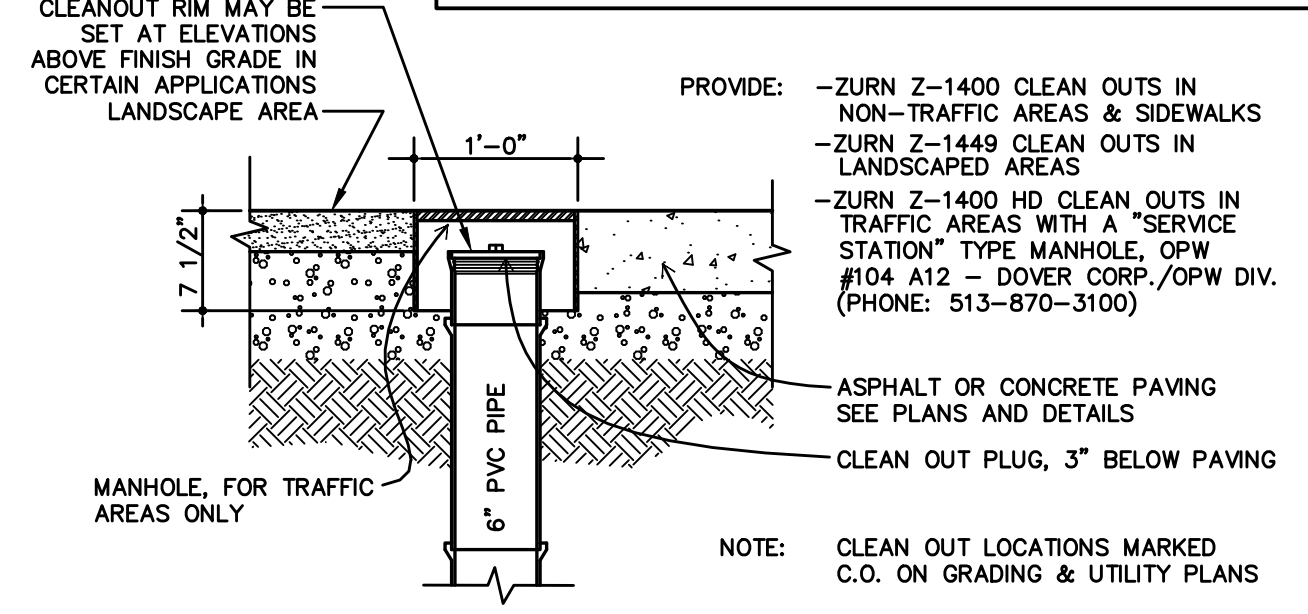

**CLEANOUT** NOT TO SCALE

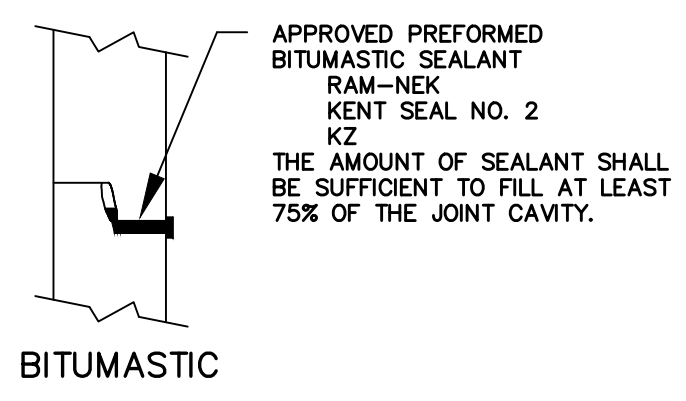

NOTE: ALL GASKETS, SEALANTS, MORTAR, ETC. SHALL BE INSTALLED IN ACCORDANCE WITH MANUFACTURERS WRITTEN INSTRUCTIONS.

**SEWER MANHOLE DETAIL B** NOT TO SCALE

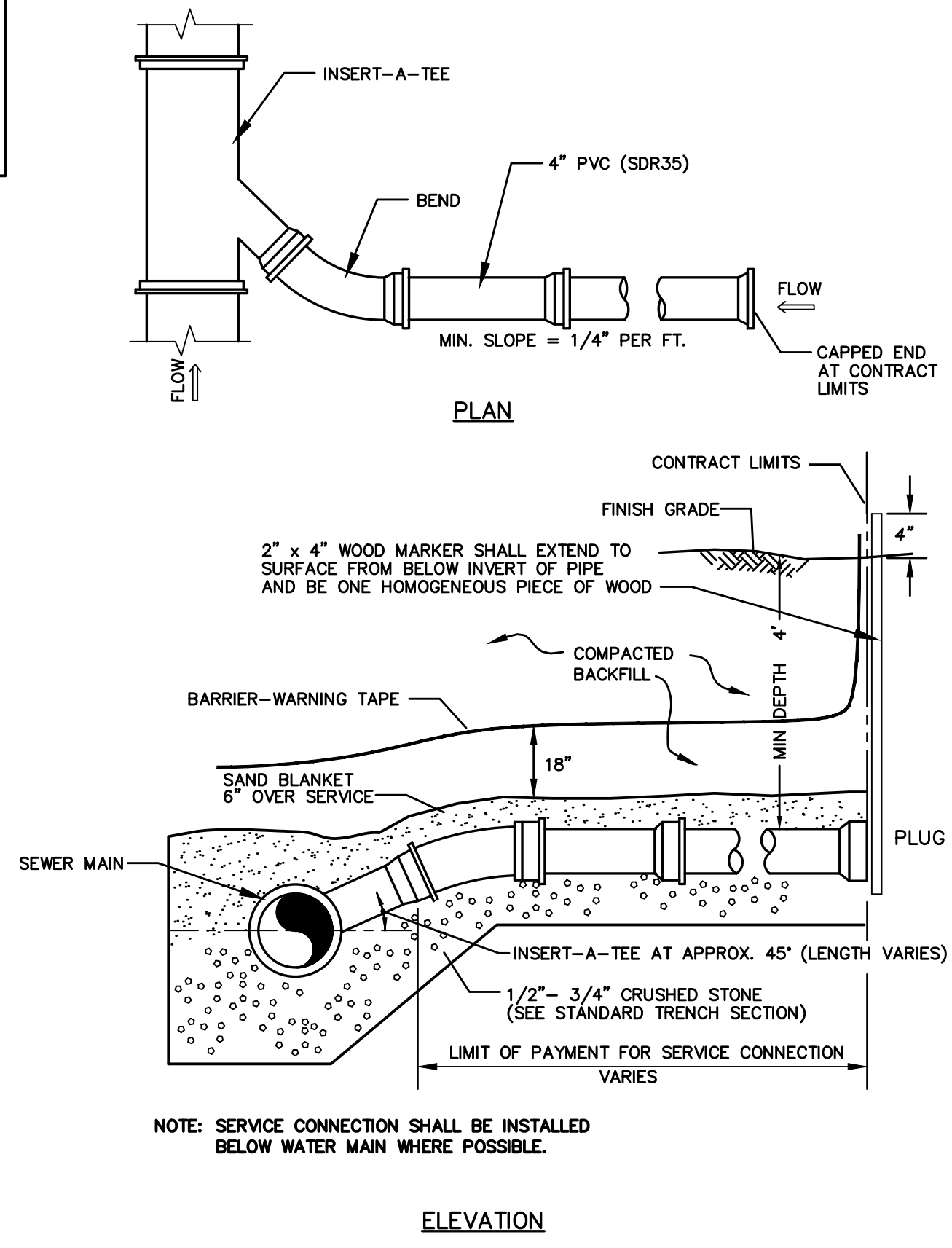

**SEWER SERVICE CONNECTION** NOT TO SCALE

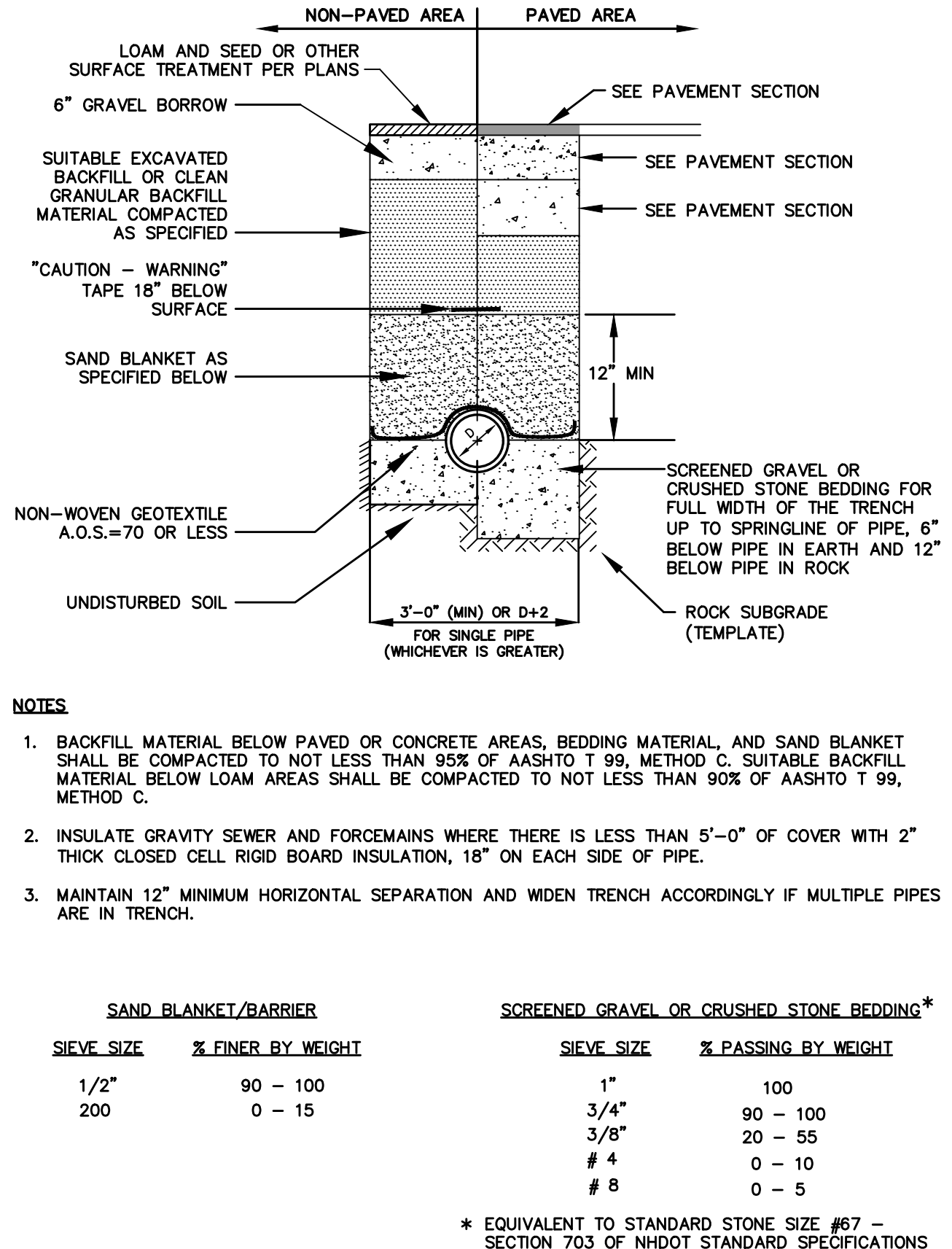

**SEWER TRENCH** NOT TO SCALE

**STANDARD TRENCH NOTES**

- ORDERED EXCAVATION OF UNSUITABLE MATERIAL BELOW GRADE: BACKFILL AS STATED IN THE TECHNICAL SPECIFICATIONS OR AS SHOWN ON THE DRAWING.
- BEDDING: SCREENED GRAVEL AND/OR CRUSHED STONE FREE FROM CLAY, LOAM, ORGANIC MATTER AND MEETING THE GRADATION SHOWN IN THE TRENCH DETAIL. WHERE ORDERED BY THE ENGINEER TO STABILIZE THE BASE, SCREENED GRAVEL OR CRUSHED STONE 1-1/2 INCH TO 1/2 INCH SHALL BE USED.
- SAND BLANKET: CLEAN SAND FREE FROM ORGANIC MATTER MEETING THE GRADATION SHOWN IN THE TRENCH DETAIL. BLANKET MAY BE REPLACED WITH BEDDING MATERIAL FOR CAST-IRON, DUCTILE IRON, AND REINFORCED CONCRETE PIPE PROVIDED THAT NO STONE LARGER THAN 2" IS IN CONTACT WITH THE PIPE AND THE GEOTEXTILE IS RELOCATED ACCORDINGLY.
- SUITABLE MATERIAL: IN ROADS, ROAD SHOULDERS, WALKWAYS AND TRAVELED DURING, SUITABLE MATERIAL FOR TRENCH BACKFILL SHALL BE THE NATURAL MATERIAL EXCAVATED DURING THE COURSE OF CONSTRUCTION, BUT SHALL EXCLUDE DEBRIS, PIECES OF PAVEMENT, ORGANIC MATTER, TOP SOIL, ALL WET OR SOFT MUCK, PEAT, OR CLAY, ALL EXCAVATED LEDGE MATERIAL, ALL ROCKS OVER 6 INCHES IN LARGEST DIMENSION, AND ANY MATERIAL WHICH, AS DETERMINED BY THE ENGINEER, WILL NOT PROVIDE SUFFICIENT SUPPORT OR MAINTAIN THE COMPLETED CONSTRUCTION IN A STABLE CONDITION. IN CROSS COUNTRY CONSTRUCTION, SUITABLE MATERIAL SHALL BE AS DESCRIBED ABOVE, EXCEPT THAT THE ENGINEER MAY PERMIT THE USE OF TOP SOIL, LOAM, MUCK, OR PEAT ONLY IF SATISFIED THAT THE COMPLETED CONSTRUCTION WILL BE ENTIRELY STABLE AND PROVIDED THAT EASY ACCESS TO THE SEWER FOR MAINTENANCE AND POSSIBLE RECONSTRUCTION WILL BE PRESERVED.
- BASE COURSE AND PAVEMENT SHALL MEET THE REQUIREMENTS OF THE NEW HAMPSHIRE DEPARTMENT OF TRANSPORTATION'S LATEST EDITION OF THE STANDARD SPECIFICATIONS FOR HIGHWAYS AND BRIDGES - DIVISIONS 300 AND 400 RESPECTIVELY.
- W = MAXIMUM ALLOWABLE TRENCH WIDTH TO A PLANE 12 INCHES ABOVE THE PIPE. FOR PIPES 15 INCHES NOMINAL DIAMETER OR LESS, W SHALL BE NO MORE THAN 36 INCHES. FOR PIPES GREATER THAN 15 INCHES IN NOMINAL DIAMETER, W SHALL BE 24 INCHES PLUS PIPE OUTSIDE DIAMETER (O.D.) ALSO, W SHALL BE THE PAYMENT WIDTH FOR LEDGE EXCAVATION AND FOR ORDERED EXCAVATION BELOW GRADE.
- FOR CROSS COUNTRY CONSTRUCTION, BACKFILL, FILL AND/OR LOAM SHALL BE MOUND TO A HEIGHT OF 6 INCHES ABOVE THE ORIGINAL GROUND SURFACE.
- CONCRETE FOR ENCASEMENT SHALL CONFORM TO THE NEW HAMPSHIRE DEPARTMENT OF PUBLIC WORKS AND HIGHWAYS STANDARD SPECIFICATION REQUIREMENTS FOR CLASS A (3000#) CONCRETE AS FOLLOWS:  
CEMENT: 6.0 BAGS PER CUBIC YARD  
WATER: 5.75 GALLONS PER BAG  
CEMENT MAXIMUM SIZE OF AGGREGATE: 1 INCH  
CONCRETE ENCASEMENT IS NOT ALLOWED FOR PVC PIPE.
- CONCRETE FULL ENCASEMENT: IF FULL ENCASEMENT IS UTILIZED, DEPTH OF CONCRETE BELOW PIPE SHALL BE 1/4 I.D. (4" MINIMUM). BLOCK SUPPORT SHALL BE SOLID CONCRETE BLOCKS.
- NEW HAMPSHIRE DEPARTMENT OF ENVIRONMENTAL SERVICES DESIGN STANDARDS REQUIRE TEN FEET (10') SEPARATION BETWEEN WATER AND SEWER. REFER TO TOWN'S STANDARD SPECIFICATIONS FOR METHODS OF PROTECTION IN AREAS THAT CANNOT MEET THESE REQUIREMENTS.
- THE CONTRACTOR SHALL INSTALL TRENCH DAMS IN ACCORDANCE WITH NHDES REGULATIONS.
- ALL GRAVITY SEWER INSTALLATIONS SHALL BE TESTED IN ACCORDANCE WITH NHDES ENV-WQ 704.06.

**NOTES**

- BACKFILL MATERIAL BELOW PAVED OR CONCRETE AREAS, BEDDING MATERIAL, AND SAND BLANKET SHALL BE COMPACTED TO NOT LESS THAN 95% OF AASHTO T 99, METHOD C. SUITABLE BACKFILL MATERIAL BELOW LOAM AREAS SHALL BE COMPACTED TO NOT LESS THAN 90% OF AASHTO T 99, METHOD C.
- INSULATE GRAVITY SEWER AND FORCEMAINS WHERE THERE IS LESS THAN 5'-0" OF COVER WITH 2" THICK CLOSED CELL RIGID BOARD INSULATION, 18" ON EACH SIDE OF PIPE.
- MAINTAIN 12" MINIMUM HORIZONTAL SEPARATION AND WIDEN TRENCH ACCORDINGLY IF MULTIPLE PIPES ARE IN TRENCH.

SAND BLANKET/BARRIER		SCREENED GRAVEL OR CRUSHED STONE BEDDING*	
SIZE	% FINER BY WEIGHT	SIZE	% PASSING BY WEIGHT
1/2"	90 - 100	1"	100
200	0 - 15	3/4"	90 - 100
		3/8"	20 - 55
		# 4	0 - 10
		# 8	0 - 5

\* EQUIVALENT TO STANDARD STONE SIZE #67 - SECTION 703 OF NHDOT STANDARD SPECIFICATIONS

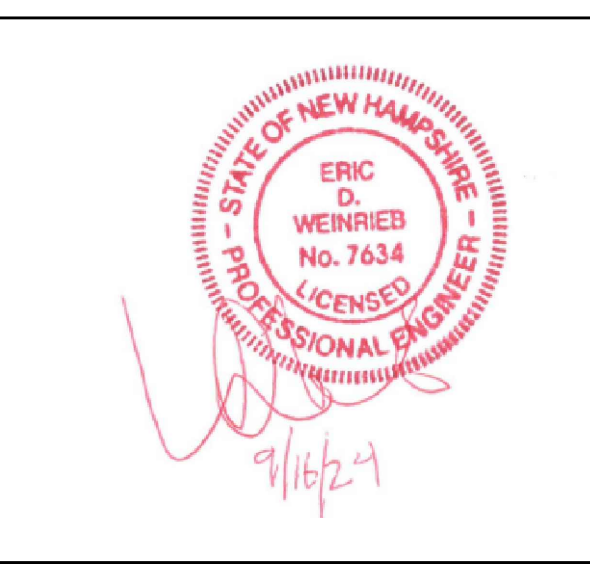
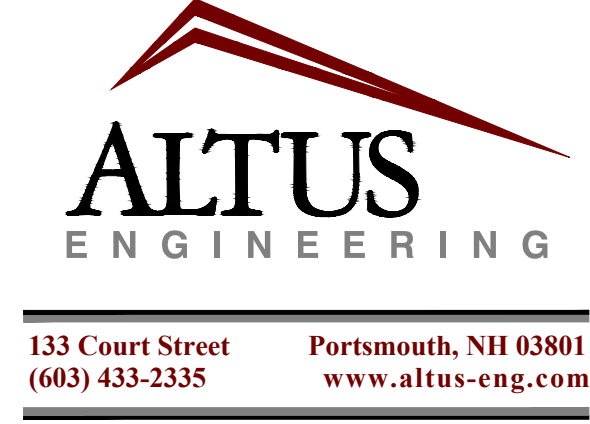

NOT FOR CONSTRUCTION

ISSUED FOR: TAC APPLICATION

ISSUE DATE: SEPTEMBER 16, 2024

REVISIONS

NO.	DESCRIPTION	BY	DATE
0	INITIAL SUBMISSION	EDW	09/16/24

DRAWN BY: \_\_\_\_\_ JMG  
APPROVED BY: \_\_\_\_\_ EDW  
DRAWING FILE: 5991-DETAILS.dwg

SCALE: NOT TO SCALE

OWNER:  
**FRANCES E. MOUFLOUZE, TED W. ALEX & PATRICIA CAMERON, TRUSTEES**  
**THE FRANCES E. MOUFLOUZE REVOCABLE TRUST OF 2015**  
104 LOCKE RD  
RYE, NH 03870

APPLICANT:  
**GREEN & COMPANY**  
11 LAFAYETTE ROAD  
P.O. BOX 1297  
NORTH HAMPTON, NH 03862

PROJECT:  
**PROPOSED 3 LOT SUBDIVISION**  
TAX MAP 222, LOT 11  
550 SAGAMORE ROAD  
PORTSMOUTH, NH 03801

TITLE:  
**CONSTRUCTION DETAILS**

SHEET NUMBER:  
**D-6**

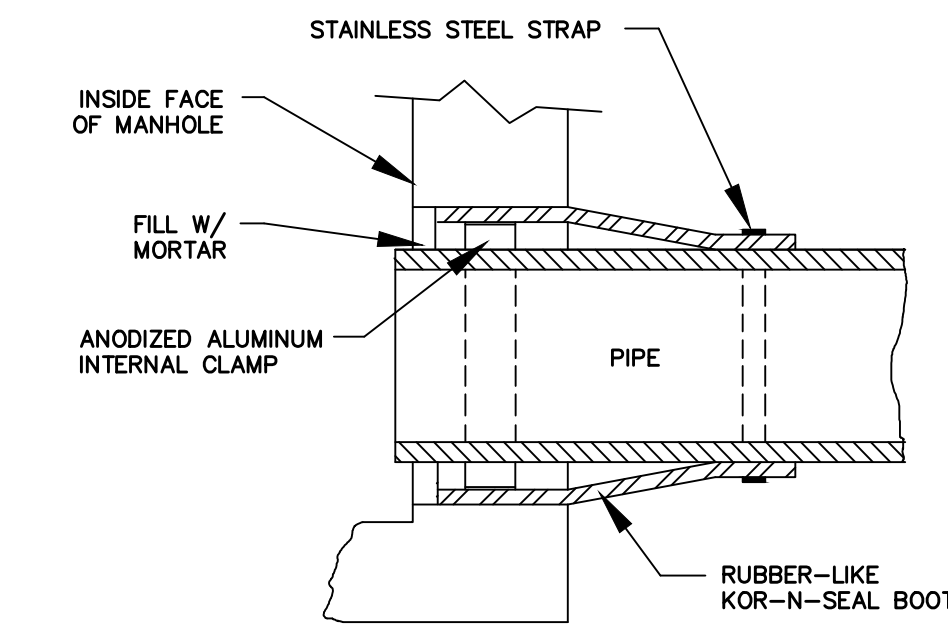

**SEWER MANHOLE DETAIL A** NOT TO SCALE

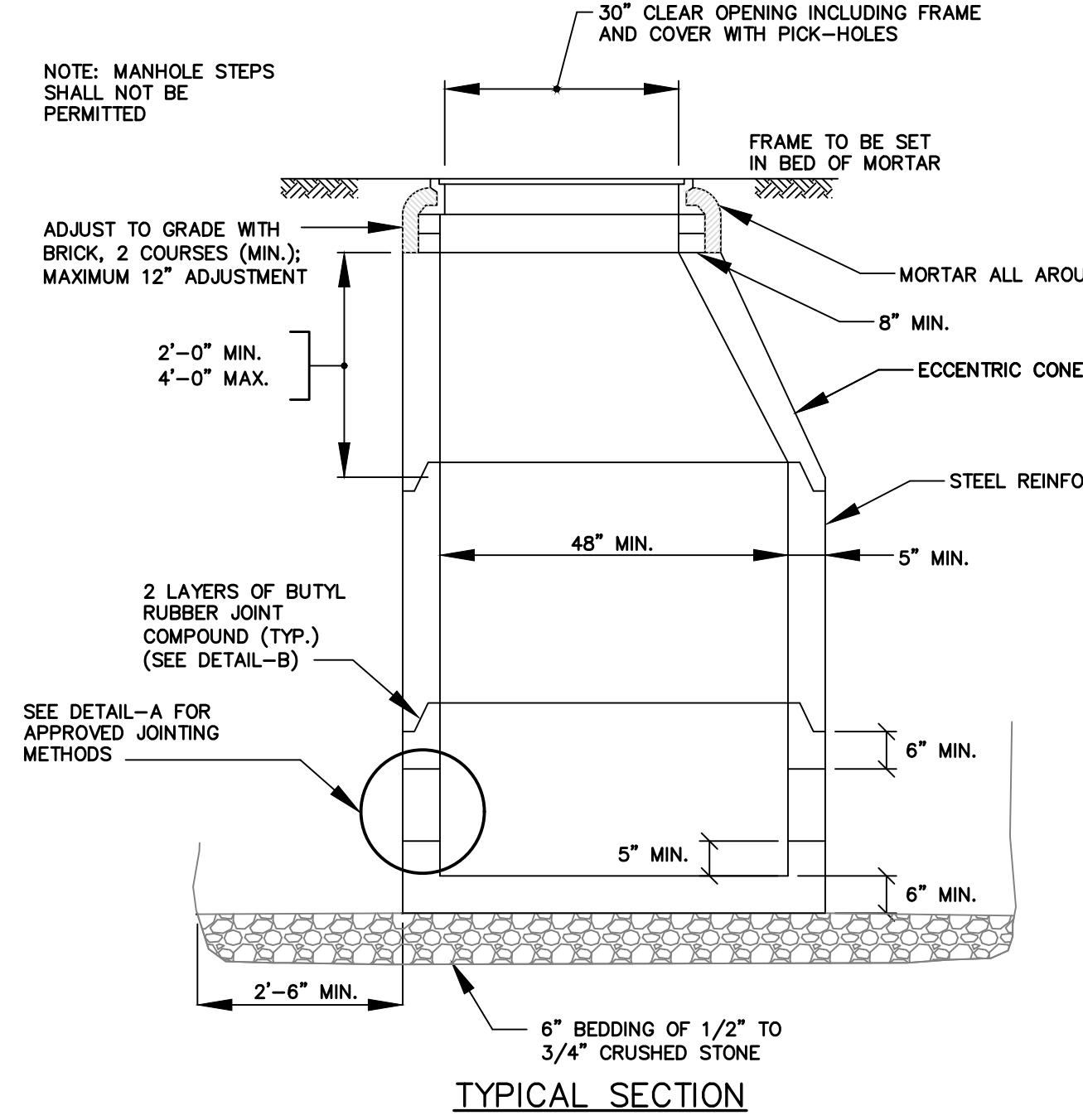

**SEWER MANHOLE** NOT TO SCALE

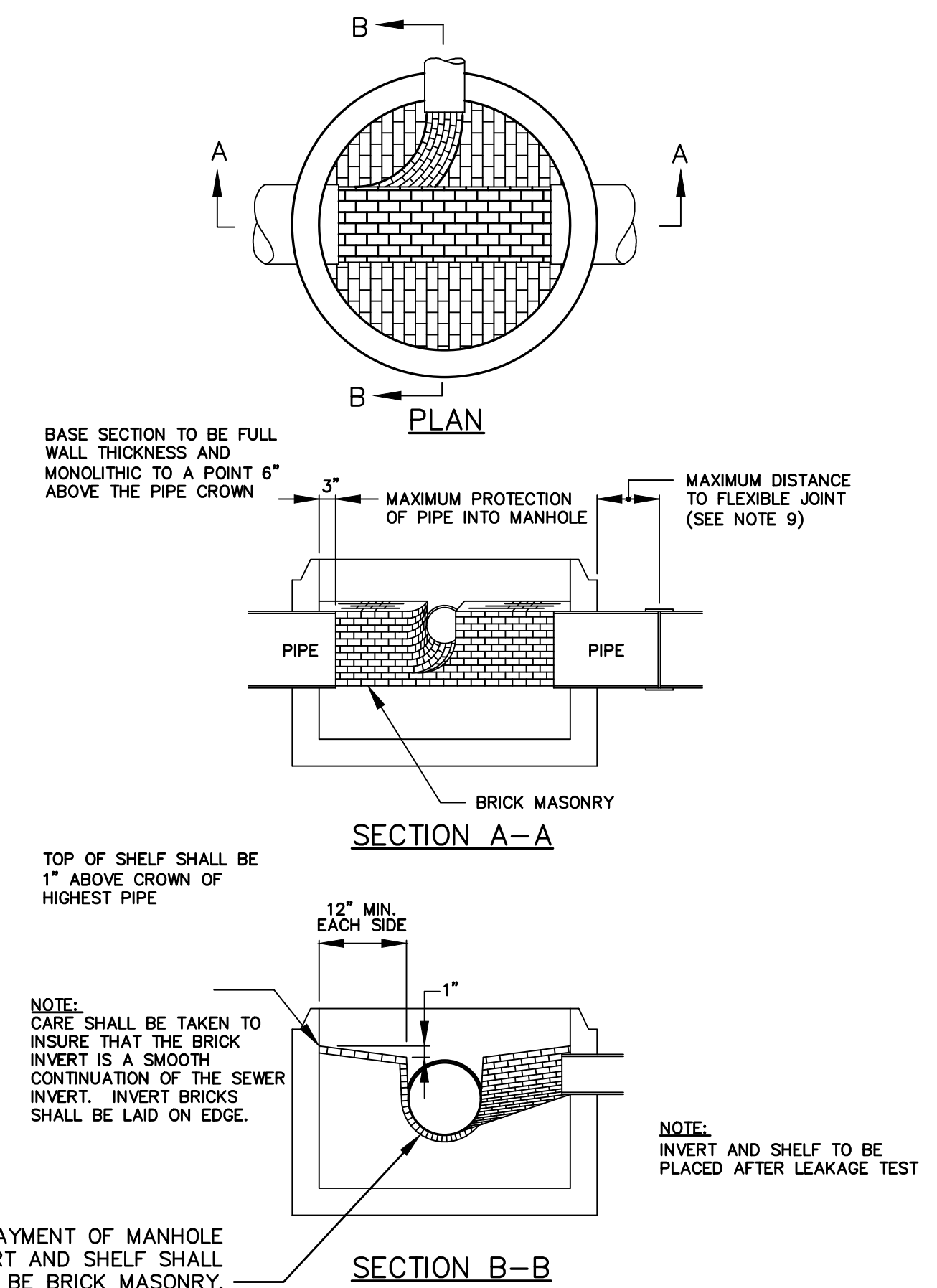

**SEWER MANHOLE** NOT TO SCALE

**MANHOLE NOTES:**

- IT IS THE INTENTION OF THE NHDES THAT THE MANHOLE, INCLUDING ALL COMPONENT PARTS, HAVE ADEQUATE SPACE, STRENGTH AND LEAKPROOF QUALITIES CONSIDERED NECESSARY BY THE COMMISSION FOR THE INTENDED SERVICE. SPACE REQUIREMENTS AND CONFIGURATIONS, SHALL BE AS SHOWN ON THE DRAWING. MANHOLES MAY BE AN ASSEMBLY OF PRECAST SECTIONS, WITH OR WITHOUT STEEL REINFORCEMENT, WITH ADEQUATE JOINTING, OR CONCRETE CAST MONOLITHICALLY IN PLACE WITH OR WITHOUT REINFORCEMENT IN ANY APPROVED MANHOLE. THE COMPLETE STRUCTURE SHALL BE OF SUCH MATERIAL AND QUALITY AS TO WITHSTAND LOADS OF 8 TONS (H-20 LOADING) WITHOUT FAILURE AND PREVENT LEAKAGE IN EXCESS OF ONE GALLON PER DAY PER VERTICAL FOOT OF MAN-HOLE CONTINUOUSLY FOR THE LIFE OF THE STRUCTURE, A PERIOD GENERALLY IN EXCESS OF 25 YEARS IS TO BE UNDERSTOOD IN BOTH CASES.
- BARRELS AND CONE SECTIONS SHALL BE PRECAST REINFORCED.
- PRECAST CONCRETE BARREL SECTIONS, CONES AND BASES SHALL CONFORM TO ASTM C478.
- LEAKAGE TEST SHALL BE PERFORMED IN ACCORDANCE WITH THE TOWN'S STANDARD SPECIFICATIONS AND WITH NHDES Env-Wq 704.17.
- INVERTS AND SHELVES MANHOLES SHALL HAVE A BRICK PAVED SHELF AND INVERT CONSTRUCTED TO CONFORM TO THE SIZE OF PIPE AND FLOW AT CHANGES IN DIRECTION. THE INVERTS SHALL BE LAID OUT IN CURVES, OF THE LONGEST RADIUS POSSIBLE TANGENT TO THE CENTER LINE OF THE SEWER PIPES. SHELVES SHALL BE CONSTRUCTED TO THE ELEVATION OF THE HIGHEST PIPE CROWN AND SLOPE TO DRAIN TOWARD THE FLOWING THROUGH CHANNEL. UNDERLAYMENT OF INVERT AND SHELF SHALL CONSIST OF BRICK MASONRY. BRICK MASONRY SHALL CONFORM WITH ASTM C32.
- MORTAR MORTAR USED FOR MANHOLE CONSTRUCTION SHALL CONFORM WITH NHDES Env-Wq 704.13.
- FRAMES AND COVERS MANHOLE FRAMES AND COVERS SHALL CONFORM WITH ASTM A48/48M, BE OF HEAVY DUTY DESIGN AND PROVIDE A 30-INCH CLEAR OPENING. A 3-INCH (MINIMUM HEIGHT) LETTER "S" FOR SEWERS OR "D" FOR DRAINS SHALL BE PLAINLY CAST INTO THE CENTER OF EACH COVER.
- BEDDING SCREENED GRAVEL AND/OR CRUSHED STONE FREE FROM CLAY, LOAM, ORGANIC MATTER AND MEETING ASTM C33.  
100% PASSING 1 INCH SCREEN 0-10% PASSING #4 SIEVE  
90-100% PASSING 3/4 INCH SCREEN 0-5% PASSING #8 SIEVE  
20- 55% PASSING 3/8 INCH SCREEN  
WHERE ORDERED BY THE ENGINEER TO STABILIZE THE BASE, SCREENED GRAVEL OR CRUSHED STONE 1-1/2" TO 1/2" SHALL BE USED.
- CONCRETE FOR DROP SUPPORT SHALL CONFORM TO THE REQUIREMENT FOR CLASS A (3000 LBS.) CONCRETE OF THE NEW HAMPSHIRE DEPARTMENT OF TRANSPORTATION STANDARD SPECIFICATIONS AS FOLLOWS:  
CEMENT 6.0 BAGS PER CUBIC YARD  
WATER 5.75 GALLONS PER BAG CEMENT  
MAXIMUM SIZE OF AGGREGATE 1 INCH 9.
- FLEXIBLE JOINT A FLEXIBLE JOINT SHALL BE PROVIDED WITHIN THE FOLLOWING DISTANCES:  
PVC PIPE - 60"  
RCP & CI PIPE - ALL SIZES - 48"  
AC & VC PIPE - UP THROUGH 12" DIAMETER - 18"  
AC & VC PIPE - LARGER THAN 12" DIAMETER - 36"
- SHALLOW MANHOLE IN LIEU OF A CONE SECTION, WHEN MANHOLE DEPTH IS LESS THAN 6 FEET, A REINFORCED CONCRETE SLAB COVER MAY BE USED HAVING AN ECCENTRIC ENTRANCE OPENING AND CAPABLE OF SUPPORTING H-20 LOADS.

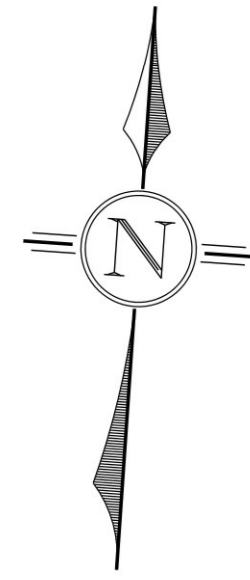

SAGAMORE AVENUE



**PLANTING NOTES:**

THE LANDSCAPE INSTALLATION CONTRACTOR SHALL LOCATE AND VERIFY ALL EXISTING UTILITIES PRIOR TO STARTING WORK.

THE CONTRACTOR SHALL CONFORM TO THE GUIDELINES ESTABLISHED BY THE CURRENT AMERICAN STANDARD FOR NURSERY STOCK PUBLISHED BY THE AMERICAN ASSOCIATION OF NURSERYMEN.

THE DEVELOPER SHALL PLANT A MINIMUM OF THE AMOUNT OF SHRUBS AND TREES SHOWN ON THE PLANT LIST, BUT EXACT SPECIES MAY VARY BASED ON PLANT AVAILABILITY.

ALL PLANT MATERIAL SHALL BE WATERED THOROUGHLY DURING THE FIRST 24 HOUR PERIOD AFTER PLANTED. PLANTS SHALL BE WATERED WEEKLY OR MORE AS NECESSARY DURING THE FIRST GROWING YEAR.

ALL PLANT MATERIAL SHALL BE GUARANTEED BY THE CONTRACTOR FOR ONE FULL YEAR FROM THE TIME OF OWNER ACCEPTANCE.

ALL TREES, SHRUBS AND PERENNIALS SHALL BE PLANTED IN MULCH BEDS EXCEPT WHERE SPECIFIED ON THE PLAN.

THE CONTRACTOR SHALL REMOVE WEEDS, ROCKS, CONSTRUCTION DEBRIS, ETC. FROM ANY LANDSCAPE AREA UNLESS DESIGNATED TO REMAIN.

ALL MULCH AREAS SHALL RECEIVE A 3 INCH LAYER OF NATURAL BARK MULCH OVER A CONSTRUCTION GRADE WEED MAT BARRIER.

THE HOUSE FOUNDATION WILL HAVE STONE MULCH BORDER EXTENDING OUT 15 INCHES FROM FOUNDATION AS DRIP EDGE. THE STONE MULCH SHALL BE 3 INCH DEPTH OVER A CONSTRUCTION GRADE WEED MAT BARRIER.

THIS PLAN SHEET IS INTENDED FOR LANDSCAPING PURPOSES ONLY. REFER TO CIVIL AND SITE SHEETS FOR ALL OTHER SITE CONSTRUCTION INFORMATION.

LEDGE SHALL BE REMOVED MINIMUM OF 3 FEET BELOW ALL PLANTINGS FOR PLANT SURVIVABILITY.

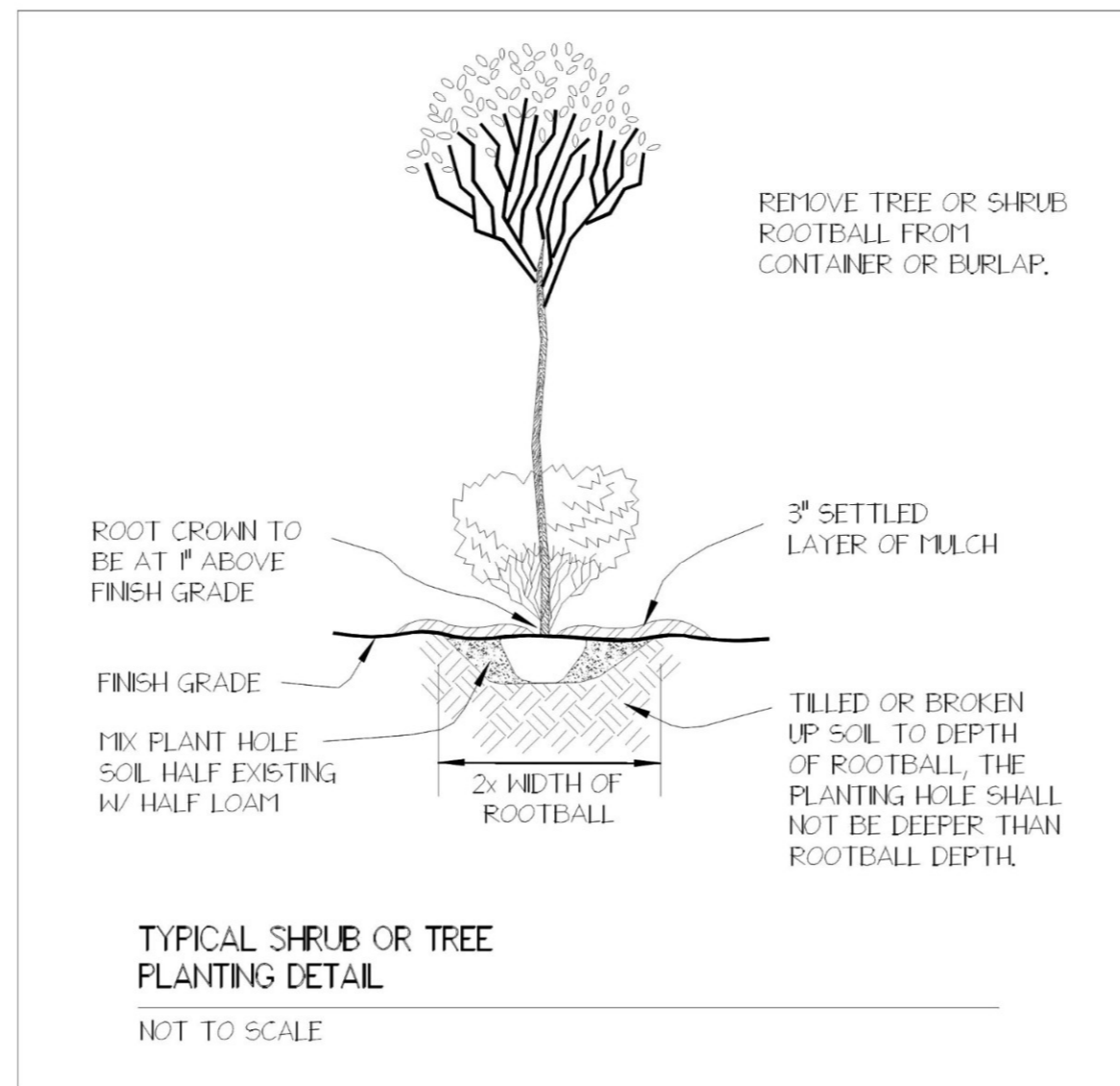

**PLANT LIST**

Quantity	Botanical Name	Common Name	Size	Growth Habits
2	Acer rubrum 'October Glory'	OCTOBER GLORY RED MAPLE	** + 3" Caliper	60'x40' upright tree
2	Amelanchier x grandiflora 'Robin Hill'	ROBIN HILL SERVICEBERRY	** + 15 Gallon	20'x15' spreading tree
2	Buxus 'Green Velvet'	GREEN VELVET BOXWOOD	5 Gallon	3'x4' evergreen shrub
1	Buxus microphylla 'Franklins Gem'	FRANKLINS GEM BOXWOOD	3 Gallon	3'x3' evergreen shrub
2	Chamaecyparis pisifera 'Mop'	MOP GOLD THREAD CYPRESS	5 Gallon	4'x4' conifer shrub
10	Cedrus atlantica	SUMMER SWEET	** + 5 Gallon	8'x6' flowering shrub
1	Deutzia gracilis 'Nikko'	NIKKO SLENDER DEUTZIA	** 3 Gallon	3'x4' flowering shrub
5	Geranium sanguineum 'NH Purple'	NH PURPLE CRANESBILL	1 Gallon	18" summer color perennial
1	Hydrangea arborescens 'Abetwo'	INCREDIBALL HYDRANGEA	5 Gallon	4'x4' flowering shrub
2	Hydrangea macrophylla 'SMHMTAU'	LET'S DANCE BLUE HYDRANGEA	** 3 Gallon	3'x4' flowering shrub
1	Ilex crenata 'Soft Touch'	SOFT TOUCH HOLLY	3 Gallon	3'x3' evergreen shrub
4	Ilex glabra 'Shamrock'	SHAMROCK INKBERRY HOLLY	** + 5 Gallon	5'x4' evergreen shrub
2	Itea virginica 'Sprich Little Henry'	LITTLE HENRY SWEETSPIRE	** 3 Gallon	3'x4' flowering shrub
2	Juniperus horizontalis 'Wiltonii'	WILTONII CREEPING JUNIPER	** + 3 Gallon	1'x6' spreading conifer shrub
4	Juniperus scopulorum 'Wichita Blue'	WICHITA BLUE MT JUNIPER	** 6-7 Ft. Ht.	18'x6' conifer tree
3	Juniperus virginiana	EASTERN RED CEDAR	** + 6-7 Ft. Ht.	30'x15' conifer tree
2	Liriodendron tulipifera	TULIP TREE	** + 3" Caliper	50'x35' upright tree
8	Miscanthus sinensis 'Morning Light'	MORNING LIGHT MAIDEN GRASS	** 2 Gallon	4' tall fountain grass
1	Nepeta x faassenii 'Blue Wonder'	BLUE WONDER CATMINT	** 1 Gallon	18" summer color perennial
2	Panicum virgatum 'Heavy Metal'	HEAVY METAL SWITCH GRASS	** + 2 Gallon	5' tall narrow grass
2	Pennisetum orientale 'Karley Rose'	KARLEY ROSE FOUNTAIN GRASS	2 Gallon	3' tall fountain grass
1	Physocarpus opulifolius 'Seward'	SUMMER WINE NINEBARK	** + 5 Gallon	6'x5' flowering shrub
2	Pieris japonica 'Cavatine'	CAVATINE JAPANESE PIERIS	5 Gallon	5'x4' evergreen flowering shrub
9	Pinus strobus	EASTERN WHITE PINE	** + 8-9 Ft. Ht.	60'x30' conifer tree
6	Rosa 'Pink Drift'	PINK DRIFT ROSE	3" Caliper	2'x3' flowering shrub
5	Sedum 'Pink Bomb'	PINK BOMB SEDUM	** 1 Gallon	18" fall color perennial
2	Syringa reticulata 'Ivory Silk'	IVORY SILK TREE LILAC	2.5" Caliper	30'x20' upright flowering tree
1	Syringa vulgaris 'Sensation'	SENSATION COMMON LILAC	** 5 Gallon	8'x5' flowering shrub
6	Thuja occidentalis 'Nigra'	DARK AMERICAN ARBORVITAE	+ 6-7 Ft. Ht.	20'x10' conifer tree
3	Tsuga canadensis	CANADIAN HEMLOCK	+ 8-9 Ft. Ht.	60'x30' conifer tree
6	Viburnum plicatum f. tom. 'Shasta'	SHASTA DOUBLEFILE VIBURNUM	** 5 Gallon	8'x6' flowering shrub
2	Weigela florida 'Alexandra'	WINE & ROSES WEIGELA	5 Gallon	4'x4' flowering shrub

\*\* Denotes plants that are tolerant of urban conditions including road salt, soil compaction, drought, heat, and air pollution.  
+ Denotes plants that are native to the New England region.

Note: All planting shall adhere to the General Requirements outlined in section 6.3 of the Portsmouth Site Plan Review Regulations. All planting shall follow the ANSI A300 Part 6 Standard Practices for Planting and Transplanting (as amended). Additionally, all planting shall follow the Planting Requirements outlined in section 6.4 of the Portsmouth Site Plan Review Regulations.

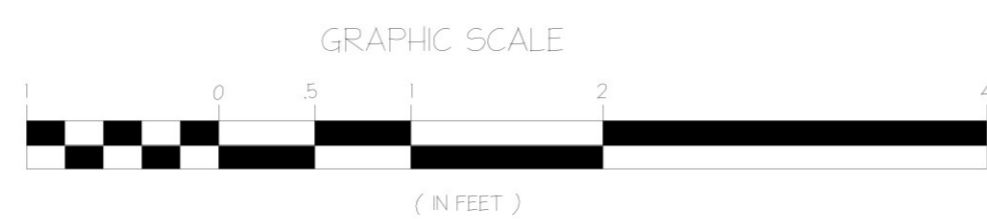

**LM**  
Land Design, LLC  
11 South Road  
Brentwood, NH 03833  
LMLandDesign.com



APPROVED BY THE PORTSMOUTH PLANNING BOARD

CHAIRMAN \_\_\_\_\_ DATE \_\_\_\_\_



133 Court Street Portsmouth, NH 03801  
(603) 433-2335 www.altus-eng.com

NOT FOR CONSTRUCTION

ISSUED FOR: TAC APPLICATION

ISSUE DATE: OCTOBER 23, 2024

NO.	DESCRIPTION	BY	DATE
0	INITIAL SUBMISSION	EDW	09/16/24
1	PER TAC COMMENTS	EDW	10/23/24

DRAWN BY: \_\_\_\_\_ LTF1  
APPROVED BY: \_\_\_\_\_ EDW  
DRAWING FILE: 559CO-1.dwg

SCALE:  
22" x 34" - 1" = 20'  
11" x 17" - 1" = 40'

OWNER:  
FRANCES E. MOUFLOUZE,  
TED W. ALEX &  
PATRICIA CAMERON, TRUSTEES  
  
THE FRANCES E. MOUFLOUZE  
REVOCABLE TRUST OF 2015  
104 LOCKE RD  
RYE, NH 03870

APPLICANT:  
GREEN & COMPANY  
11 LAFAYETTE ROAD  
P.O. BOX 1297  
NORTH HAMPTON, NH 03862

PROJECT:  
**RESIDENTIAL DEVELOPMENT**

TAX MAP 222 LOT 11  
550 SAGAMORE AVENUE  
PORTSMOUTH, NH

TITLE:  
**LANDSCAPE PLAN**

SHEET NUMBER:  
L-1

PE5-911

Letter of Authorization

I/We, Ted W Alex and Patricia Cameron trustees of The Frances E Mouflouze Revocable Trust of 2015 u/d/t dated September 24, 2015, as owner of certain real property situated in Portsmouth, NH further described 1.48 +/- acres of land with single family home located at 550 Sagamore Avenue with 140' of frontage on Sagamore Avenue, as shown in Tax Assessors Map 222 Lot 11 and further defined by legal description found at the Rockingham County Registry of Deeds Book 5660 Page 2227 dated October 7<sup>th</sup>, 2015. (hereinafter, "Property") do hereby authorize Green & Company Building and Development Corp. and its Affiliates, Agents, Assigns and Engineers to act on my/our behalf and to appear before the zoning board of adjustment and/or the planning board of said city/town and/or any of its boards or commissions, in my/our behalf for the purpose of seeking any regulatory relief that may be requested by the person I/we have above authorized, including variances, special exceptions, dimensional waivers, site plan approval, lot line adjustment approval and subdivision approval, hereby ratifying any actions taken by him/her/them to obtain any such relief. I/We authorize Green & Company Building and Development Corp. and its Affiliates, Agents, Assigns and Engineers to act in my/our behalf in all matters concerning the development and approval process, without limitation, for the above stated property, to include any required signatures.

I/We shall cooperate fully with Green & Company Building and Development Corp. and its Affiliates, Agents, Assigns and Engineers in seeking timely public approvals and for the completion of the sale contemplated herein. I/We agree to use my/our good faith efforts to provide any assistance I/we reasonably can to Green & Company Building and Development Corp. and its Affiliates, Agents, Assigns and Engineers throughout the development process, including but not limited to signing permit applications as needed.

DocuSigned by:  
*Sharon L. Hartford*  
3045470F2FB1400...

---

Witness

DocuSigned by:  
*[Signature]*  
0988B450C97142B...

---

Owner:

5/29/2024  
Date

DocuSigned by:  
*Sharon L. Hartford*  
3045470F2FB1400...

---

Witness

DocuSigned by:  
*Patricia Cameron*  
523068DE634B446...

---

Owner:

5/29/2024  
Date

# DRAINAGE ANALYSIS

FOR

## Green & Company

**550 Sagamore Ave  
Portsmouth, NH**

**Tax Map 222 Lot 11**

**September 16, 2024  
Revised October 23, 2024**

*Prepared For:*

**Green & Company**  
11 Lafayette Road  
P.O. Box 1297  
North Hampton, NH 03862

*Prepared By:*

**ALTUS ENGINEERING**  
133 Court Street  
Portsmouth, NH 03801  
Phone: (603) 433-2335



*Wale*  
*10/20/24*

Altus Project 5591

# Table of Contents

Section 1	Narrative
	Project Description
	Site Overview
	Site Soils/Wetlands
	Proposed Site Design
	Calculation Methods
	Disclaimer
	Drainage Analysis
	Conclusions
Section 2	Aerial Photo
	USGS Location Map
Section 3	Drainage Analysis, Pre-Development
Section 4	Drainage Analysis, Post-Development
Section 5	Precipitation Table
Section 6	NRCS Soils Report
Section 7	BMP Sizing Calculations
	Riprap Sizing Calculations
Section 8	Stormwater Operations and Maintenance Plan
Section 9	Watershed Plans
	Pre-Development Watershed Plan
	Post-Development Watershed Plan

# Section 1

## Narrative

## PROJECT DESCRIPTION

Green & Company is proposing to construct a 4-lot residential development located at 550 Sagamore Ave Portsmouth, New Hampshire. The 1.53-acre property is identified as Tax Map 222, Lot 11 and is located in the Single Residence-Residence B District. The site is currently developed as a single-family residence. Access to the development site is via a driveway coming off Sagamore Avenue.

The proposed project will construct a new 4-lot subdivision, with 3 buildable lots, serviced by municipal water and sewer and paved roadway together with associated stormwater infrastructure. Stormwater treatment measures include 3 bioretention ponds. Pretreatment will be provided by catch basins with deep sumps and grease hoods. The proposed stormwater management system will reduce peak flows as well as treat runoff from the site's impervious areas prior to leaving the site.

Altus met with the Technical Advisory Committee (TAC) on October 1, 2024, to review the site design. Revisions were made to address the committee's concerns.

- The southeast raingarden (node 6-P) was increased in size and moved west towards the proposed building in lot 2.
- The southeast raingarden relocation allowed the proposed tree line to be moved further from the abutting property to enhance the vegetative buffer.
- Proposed building finished floor elevations were raised to allow gravity perimeter drains.
- Basement slab elevations are now depicted on the plans.

### *Site Soils/Wetlands*

Joseph W. Noel, Wetland Scientist, completed an on-site inspection on May 10, 2024, and identified a small pocket of wetland. Based off data from the USDA National Resources Conservation Service Web Soil Survey, the site sits on 140B Chatfield-Hollis-Canton complex and 799 Urban land-Canton complex soils. Altus recognizes these soils as HSG C except for the wetland which we categorized as HSG D based on poor infiltration capacity.

### ***Pre-Development (Existing Conditions)***

The site currently features a single-family home with a deck and paved driveway. Stormwater drains into catch basins connected to the city drainage network. The site generally slopes in a westerly direction towards Sagamore Avenue. Hydrology is characterized by four existing subcatchments as delineated on the accompanying “Pre-Development Watershed Plan”. Site runoff was analyzed at four points of analysis (POA). POA #1 is in the southwest corner along Sagamore Ave, POA #2 is in the southeast corner of the property, POA #3 is the wetland located in the northern central part of the property, and POA #4 is in the northeast corner of the property.

### ***Post-Development (Proposed Conditions)***

The site plan features three homes with driveways that are connected to a private cul-de-sac.

The post-development conditions were analyzed at the same discharge point as the pre-development conditions. The post-development watersheds are delineated on the accompanying “Post-Development Watershed Plan”. Modifications to the delineated areas and associated ground cover were made to sub-catchments to account for the improvements to the property. As shown on the attached Post-Development Watershed Plan, the site was divided into nine post-development subcatchment areas. The same points of analysis in the Pre-Development model were used for comparison of the Pre- and Post-development conditions.

The Post-Development Watershed Plan illustrates the proposed stormwater management system. Site topography, existing features, proposed site improvements, proposed grading, drainage and erosion control measures are shown on the accompanying plans. Recommended erosion control measures are based upon the December 2008 edition of the “*New Hampshire Stormwater Manual Volumes 1 through 3*” prepared by NHDES and Comprehensive Environmental, Inc. as amended.

## **CALCULATION METHODS**

The drainage study was completed using the USDA SCS TR-20 Method within the HydroCAD Stormwater Modeling System. Reservoir routing was performed with the Dynamic Storage Indication method with automated calculation of tailwater conditions. A Type III 24-hour rainfall distribution was utilized in analyzing the data for the 2, 10, 25 and 50 year - 24-hour storm events using rainfall data provided by the Northeast Regional Climate Center (NRCC). A time span of 0 to 30 hours was analyzed at 0.01-hour increments. Percolation rates are from on-site measurements with significant factors of safety or based on the rate through filter media.



## *Disclaimer*

Altus Engineering, notes that stormwater modeling is limited in its capacity to precisely predict peak rates of runoff and flood elevations. Results should not be considered to represent actual storm events due to the number of variables and assumptions involved in the modeling effort. Surface roughness coefficients (n), entrance loss coefficients (ke), velocity factors (kv) and times of concentration (Tc) are based on subjective field observations and engineering judgment using available data. For design purposes, curve numbers (Cn) describe the average conditions. However, curve numbers will vary from storm to storm depending on the antecedent runoff conditions (ARC) including saturation and frozen ground. Also, higher water elevations than predicted by modeling could occur if drainage channels, closed drain systems or culverts are not maintained and/or become blocked by debris before and/or during a storm event as this will impact flow capacity of the structures. Structures should be re-evaluated if future changes occur within relevant drainage areas in order to assess any required design modifications.

*Drainage Analysis*

A complete summary of the drainage model is included in the appendix of this report. The following table compares pre- and post-development peak rates at the Points of Analysis identified on the plans for the 2, 10, 25 and 50-year storm events:

**Stormwater Modeling Summary  
Peak Q (cfs) for Type III 24-Hour Storm Events**

	<b>2-Yr Storm (3.70 inch)</b>	<b>10-Yr Storm (5.60 inch)</b>	<b>25-Yr Storm (7.12 inch)</b>	<b>50-Yr Storm (8.51 inch)</b>
<b>POA #1</b>				
Pre	0.90	1.69	2.34	2.93
Post	0.77	1.33	1.78	2.44
<b>Change</b>	<b>-0.13</b>	<b>-0.36</b>	<b>-0.56</b>	<b>-0.49</b>
<b>POA #2</b>				
Pre	0.55	1.23	1.83	2.39
Post	0.49	0.98	1.32	2.26
<b>Change</b>	<b>-0.06</b>	<b>-0.25</b>	<b>-0.51</b>	<b>-0.13</b>
<b>POA #3</b>				
Pre	0.76	1.63	2.38	3.08
Post	0.16	0.31	0.43	0.55
<b>Change</b>	<b>-0.60</b>	<b>-1.32</b>	<b>-1.95</b>	<b>-2.53</b>
<b>POA #4</b>				
Pre	0.06	0.13	0.19	0.25
Post	0.06	0.13	0.19	0.24
<b>Change</b>	<b>0.00</b>	<b>0.00</b>	<b>0.00</b>	<b>-0.01</b>

As the above table demonstrates, the proposed peak rates of runoff at the point of analysis will be decreased or unchanged from the existing conditions for all analyzed storm events.

## **CONCLUSION**

This proposed site redevelopment of property located at 550 Sagamore Avenue Portsmouth, New Hampshire will have minimal adverse effect on abutting properties and infrastructure as a result of stormwater runoff or siltation. Post-construction peak rates of runoff from the site will be lower than or the same as the existing conditions for all analyzed storm events. The new stormwater management system will also provide appropriate treatment to runoff from the proposed on-site impervious surfaces. Appropriate steps will be taken to properly mitigate erosion and sedimentation through the use of temporary and permanent Best Management Practices for sediment and erosion control, including catch basins and 3 bioretention ponds.

## Section 2

# Aerial Photo and USGS Map

550 Sagamore Ave

Legend

550 Sagamore Ave

Google Earth



200 ft

# 550 Sagamore Ave

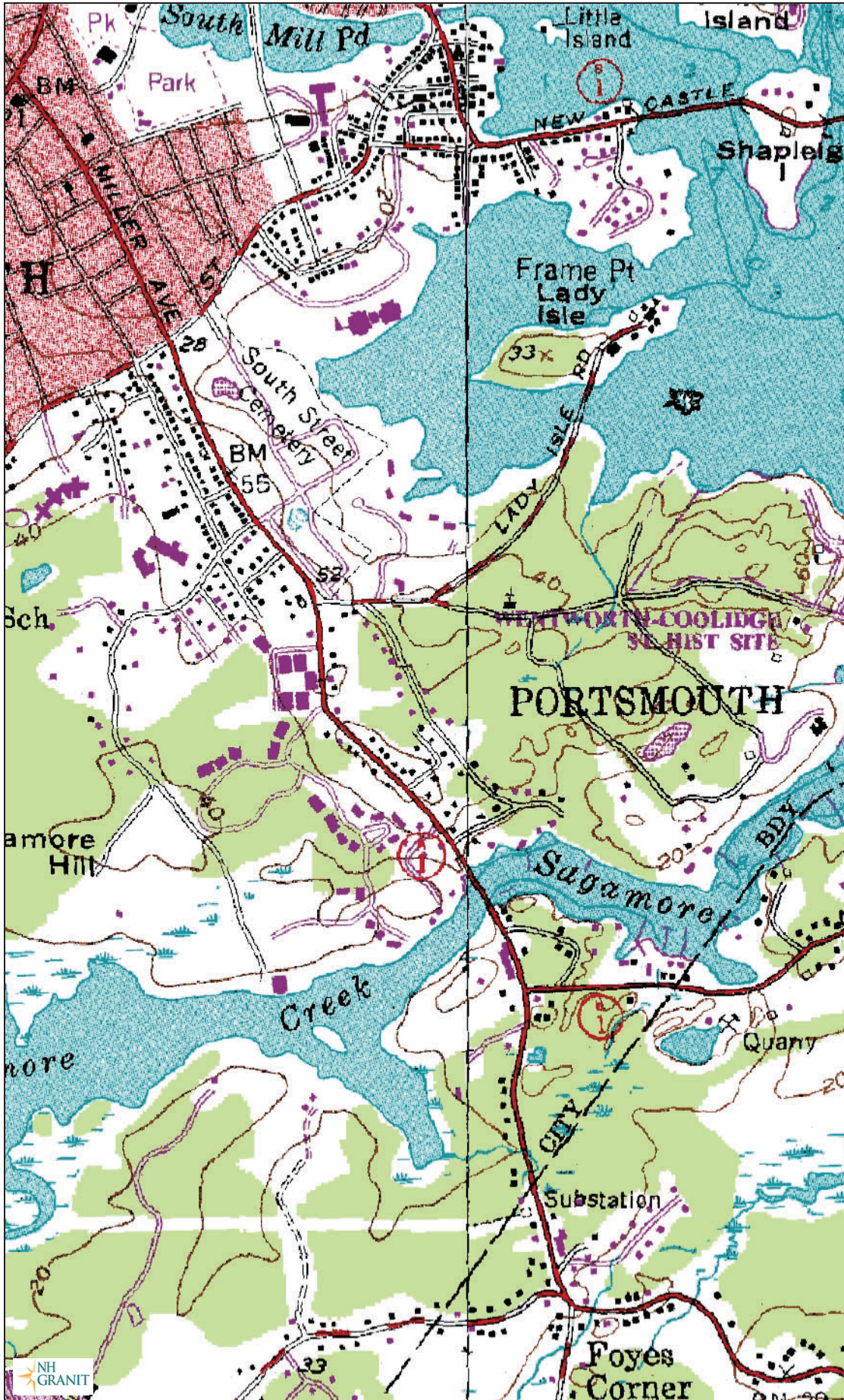

## Legend

Map Scale

1: 12,988

© NH GRANIT, [www.granit.unh.edu](http://www.granit.unh.edu)

Map Generated: 9/5/2024



## Notes

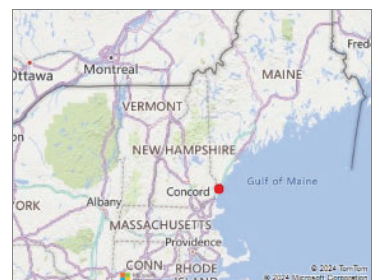

## Section 3

# Drainage Calculations

Pre-Development

2-Year, 24-Hour Summary

10-Year, 24-Hour Complete

25-Year, 24-Hour Summary

50-Year, 24-Hour Summary

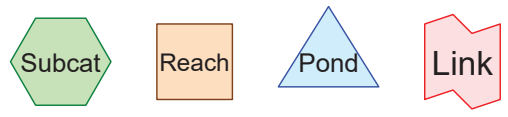
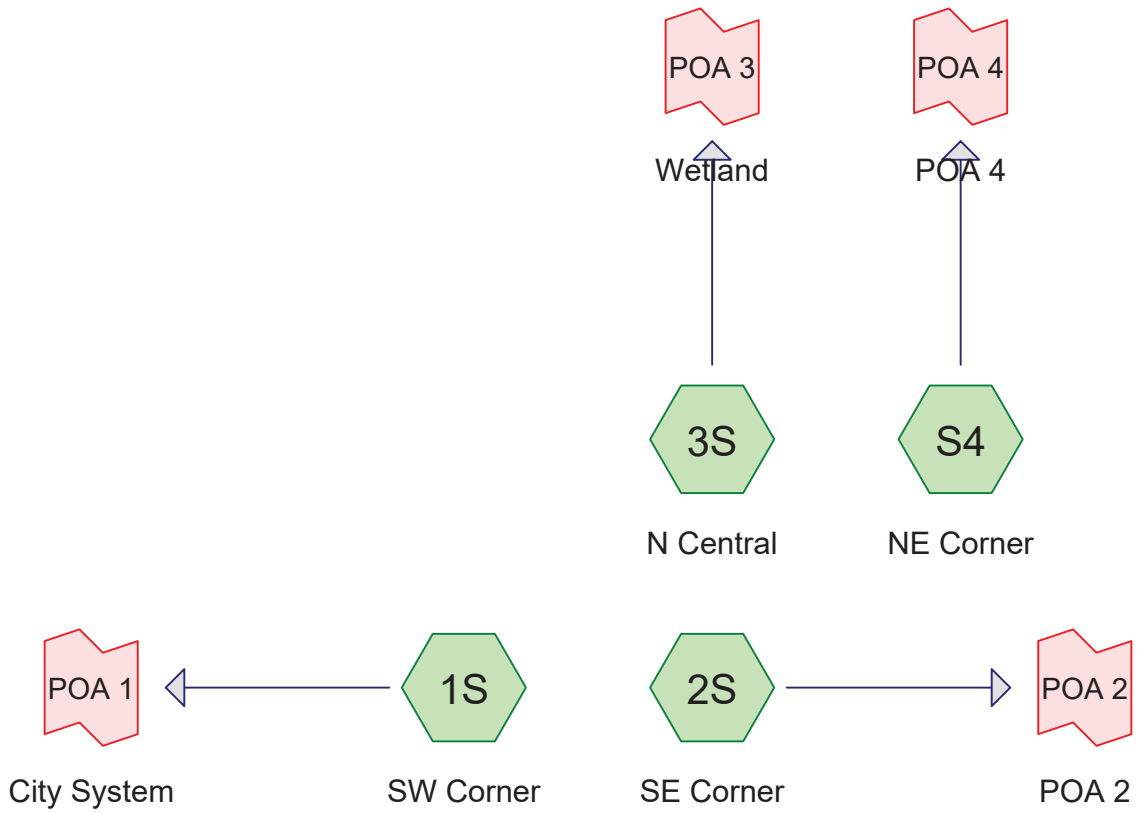



**Area Listing (all nodes)**

Area (acres)	CN	Description (subcatchment-numbers)
0.369	74	>75% Grass cover, Good, HSG C (1S, 3S)
0.188	98	Paved parking, HSG C (1S, 2S, 3S, S4)
0.041	98	Roofs, HSG C (1S, 3S)
0.909	70	Woods, Good, HSG C (1S, 2S, 3S, S4)
0.018	79	Woods/grass comb., Good, HSG D (3S)
<b>1.526</b>	<b>75</b>	<b>TOTAL AREA</b>

**Soil Listing (all nodes)**

Area (acres)	Soil Group	Subcatchment Numbers
0.000	HSG A	
0.000	HSG B	
1.508	HSG C	1S, 2S, 3S, S4
0.018	HSG D	3S
0.000	Other	
<b>1.526</b>		<b>TOTAL AREA</b>

**Ground Covers (all nodes)**

HSG-A (acres)	HSG-B (acres)	HSG-C (acres)	HSG-D (acres)	Other (acres)	Total (acres)	Ground Cover	Subcatchment Numbers
0.000	0.000	0.369	0.000	0.000	0.369	>75% Grass cover, Good	1S, 3S
0.000	0.000	0.188	0.000	0.000	0.188	Paved parking	1S, 2S, 3S, S4
0.000	0.000	0.041	0.000	0.000	0.041	Roofs	1S, 3S
0.000	0.000	0.909	0.000	0.000	0.909	Woods, Good	1S, 2S, 3S, S4
0.000	0.000	0.000	0.018	0.000	0.018	Woods/grass comb., Good	3S
<b>0.000</b>	<b>0.000</b>	<b>1.508</b>	<b>0.018</b>	<b>0.000</b>	<b>1.526</b>	<b>TOTAL AREA</b>	

Time span=0.00-30.00 hrs, dt=0.01 hrs, 3001 points  
Runoff by SCS TR-20 method, UH=SCS, Weighted-CN  
Reach routing by Dyn-Stor-Ind method - Pond routing by Dyn-Stor-Ind method

**Subcatchment 1S: SW Corner** Runoff Area=20,575 sf 31.17% Impervious Runoff Depth=3.52"  
Flow Length=184' Tc=10.2 min CN=81 Runoff=1.69 cfs 0.139 af

**Subcatchment 2S: SE Corner** Runoff Area=19,202 sf 6.08% Impervious Runoff Depth=2.67"  
Flow Length=265' Tc=9.1 min CN=72 Runoff=1.23 cfs 0.098 af

**Subcatchment 3S: N Central** Runoff Area=24,854 sf 9.30% Impervious Runoff Depth=2.85"  
Flow Length=160' Tc=10.6 min CN=74 Runoff=1.63 cfs 0.136 af

**Subcatchment S4: NE Corner** Runoff Area=1,838 sf 4.79% Impervious Runoff Depth=2.58"  
Flow Length=122' Tc=6.0 min CN=71 Runoff=0.13 cfs 0.009 af

**Link POA 1: City System** Inflow=1.69 cfs 0.139 af  
Primary=1.69 cfs 0.139 af

**Link POA 2: POA 2** Inflow=1.23 cfs 0.098 af  
Primary=1.23 cfs 0.098 af

**Link POA 3: Wetland** Inflow=1.63 cfs 0.136 af  
Primary=1.63 cfs 0.136 af

**Link POA 4: POA 4** Inflow=0.13 cfs 0.009 af  
Primary=0.13 cfs 0.009 af

**Total Runoff Area = 1.526 ac Runoff Volume = 0.381 af Average Runoff Depth = 3.00"**  
**84.98% Pervious = 1.297 ac 15.02% Impervious = 0.229 ac**

**Summary for Subcatchment 1S: SW Corner**

Runoff = 1.69 cfs @ 12.14 hrs, Volume= 0.139 af, Depth= 3.52"

Runoff by SCS TR-20 method, UH=SCS, Weighted-CN, Time Span= 0.00-30.00 hrs, dt= 0.01 hrs  
 Type III 24-hr 10 YEAR STORM Rainfall=5.60"

Area (sf)	CN	Description
737	98	Roofs, HSG C
5,677	98	Paved parking, HSG C
3,601	70	Woods, Good, HSG C
10,560	74	>75% Grass cover, Good, HSG C
20,575	81	Weighted Average
14,161		68.83% Pervious Area
6,414		31.17% Impervious Area

Tc (min)	Length (feet)	Slope (ft/ft)	Velocity (ft/sec)	Capacity (cfs)	Description
7.3	41	0.0488	0.09		<b>Sheet Flow,</b> Woods: Light underbrush n= 0.400 P2= 3.23"
2.9	143	0.0139	0.83		<b>Shallow Concentrated Flow,</b> Short Grass Pasture Kv= 7.0 fps
10.2	184	Total			

**Subcatchment 1S: SW Corner**

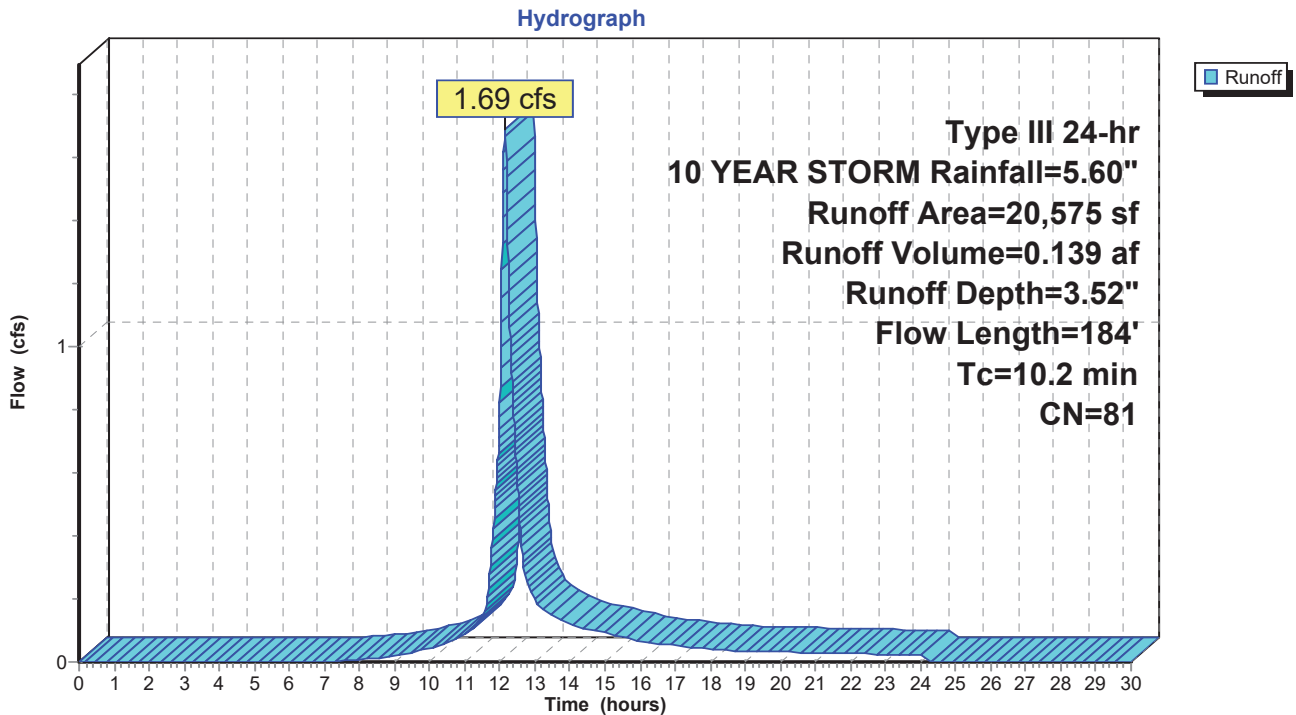

### Summary for Subcatchment 2S: SE Corner

Runoff = 1.23 cfs @ 12.13 hrs, Volume= 0.098 af, Depth= 2.67"

Runoff by SCS TR-20 method, UH=SCS, Weighted-CN, Time Span= 0.00-30.00 hrs, dt= 0.01 hrs  
 Type III 24-hr 10 YEAR STORM Rainfall=5.60"

Area (sf)	CN	Description
1,168	98	Paved parking, HSG C
18,034	70	Woods, Good, HSG C
19,202	72	Weighted Average
18,034		93.92% Pervious Area
1,168		6.08% Impervious Area

Tc (min)	Length (feet)	Slope (ft/ft)	Velocity (ft/sec)	Capacity (cfs)	Description
0.2	18	0.1000	1.87		<b>Sheet Flow,</b> Smooth surfaces n= 0.011 P2= 3.23"
6.1	40	0.0750	0.11		<b>Sheet Flow,</b> Woods: Light underbrush n= 0.400 P2= 3.23"
2.8	207	0.0628	1.25		<b>Shallow Concentrated Flow,</b> Woodland Kv= 5.0 fps
9.1	265	Total			

### Subcatchment 2S: SE Corner

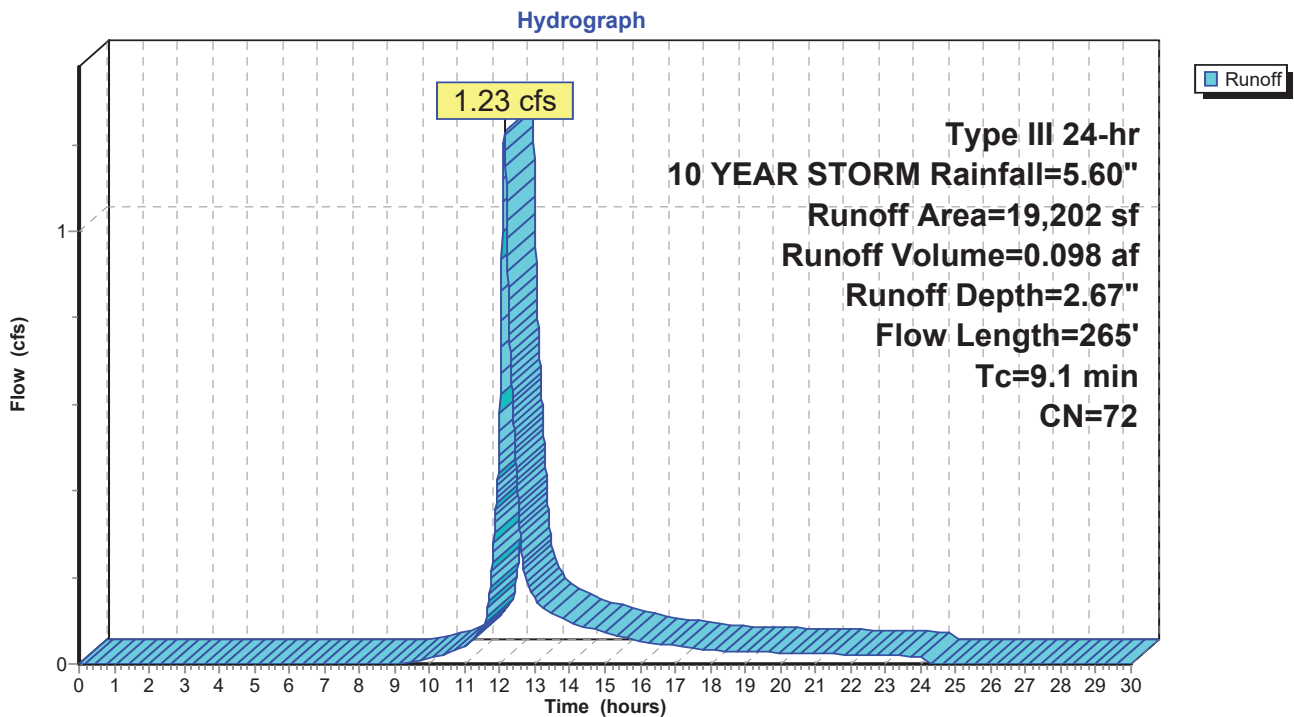

**Summary for Subcatchment 3S: N Central**

Runoff = 1.63 cfs @ 12.15 hrs, Volume= 0.136 af, Depth= 2.85"

Runoff by SCS TR-20 method, UH=SCS, Weighted-CN, Time Span= 0.00-30.00 hrs, dt= 0.01 hrs  
 Type III 24-hr 10 YEAR STORM Rainfall=5.60"

Area (sf)	CN	Description
1,070	98	Roofs, HSG C
1,241	98	Paved parking, HSG C
781	79	Woods/grass comb., Good, HSG D
16,227	70	Woods, Good, HSG C
5,535	74	>75% Grass cover, Good, HSG C
24,854	74	Weighted Average
22,543		90.70% Pervious Area
2,311		9.30% Impervious Area

Tc (min)	Length (feet)	Slope (ft/ft)	Velocity (ft/sec)	Capacity (cfs)	Description
9.4	97	0.0206	0.17		<b>Sheet Flow,</b> Grass: Short n= 0.150 P2= 3.23"
1.2	63	0.0317	0.89		<b>Shallow Concentrated Flow,</b> Woodland Kv= 5.0 fps
10.6	160	Total			

**Subcatchment 3S: N Central**

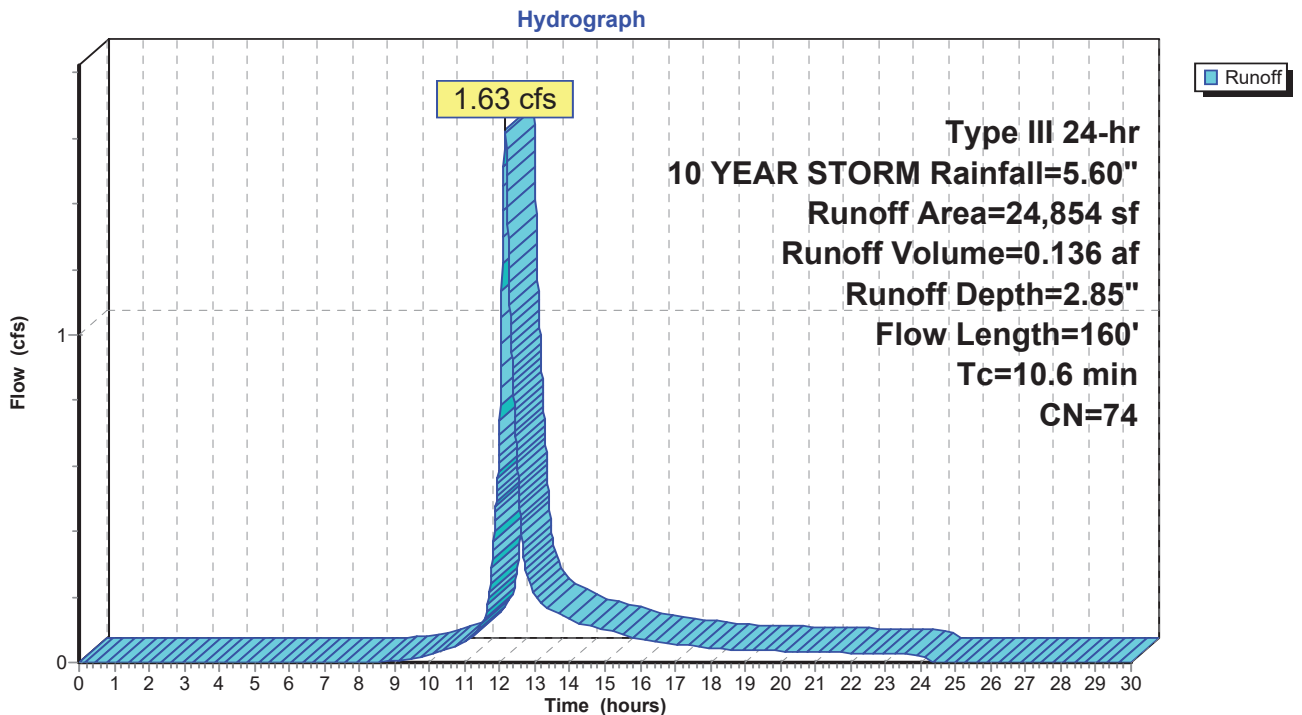

### Summary for Subcatchment S4: NE Corner

Runoff = 0.13 cfs @ 12.09 hrs, Volume= 0.009 af, Depth= 2.58"

Runoff by SCS TR-20 method, UH=SCS, Weighted-CN, Time Span= 0.00-30.00 hrs, dt= 0.01 hrs  
 Type III 24-hr 10 YEAR STORM Rainfall=5.60"

Area (sf)	CN	Description
88	98	Paved parking, HSG C
1,750	70	Woods, Good, HSG C
1,838	71	Weighted Average
1,750		95.21% Pervious Area
88		4.79% Impervious Area

Tc (min)	Length (feet)	Slope (ft/ft)	Velocity (ft/sec)	Capacity (cfs)	Description
0.4	43	0.0814	2.05		<b>Sheet Flow,</b> Smooth surfaces n= 0.011 P2= 3.23"
1.0	79	0.0696	1.32		<b>Shallow Concentrated Flow,</b> Woodland Kv= 5.0 fps
1.4	122	Total, Increased to minimum Tc = 6.0 min			

### Subcatchment S4: NE Corner

Hydrograph

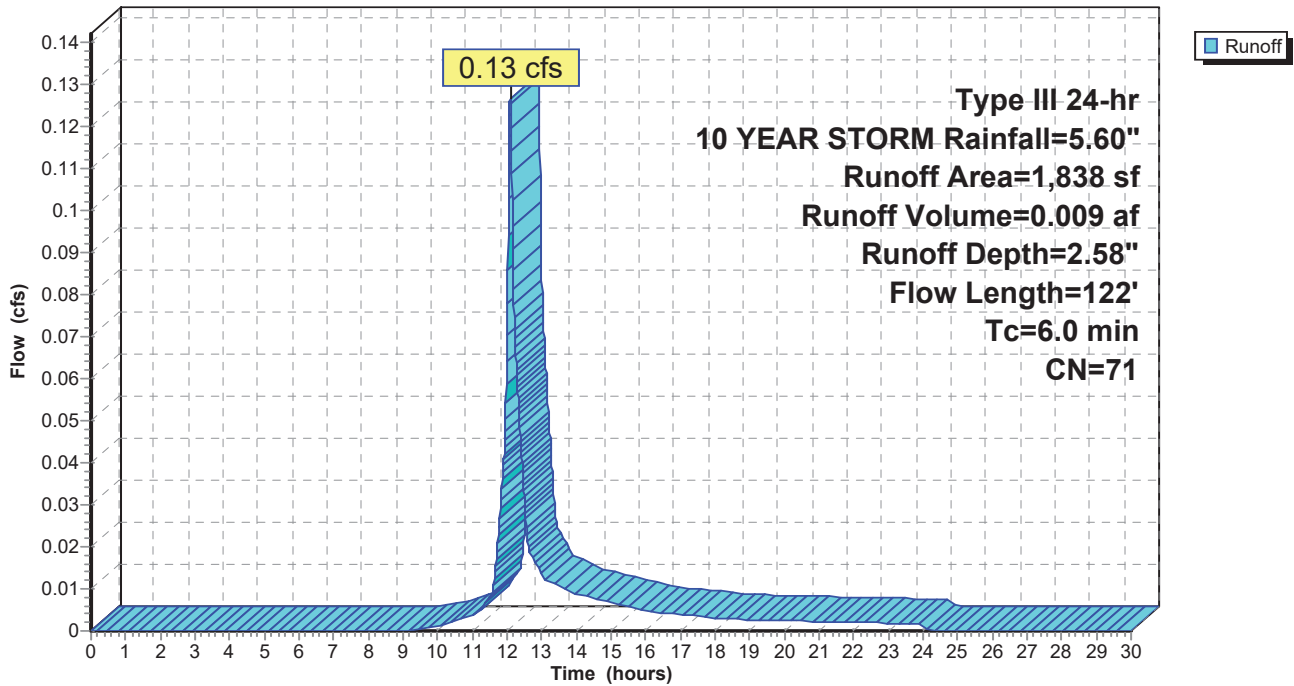



### Summary for Link POA 1: City System

Inflow Area = 0.472 ac, 31.17% Impervious, Inflow Depth = 3.52" for 10 YEAR STORM event  
Inflow = 1.69 cfs @ 12.14 hrs, Volume= 0.139 af  
Primary = 1.69 cfs @ 12.14 hrs, Volume= 0.139 af, Atten= 0%, Lag= 0.0 min

Primary outflow = Inflow, Time Span= 0.00-30.00 hrs, dt= 0.01 hrs

### Link POA 1: City System

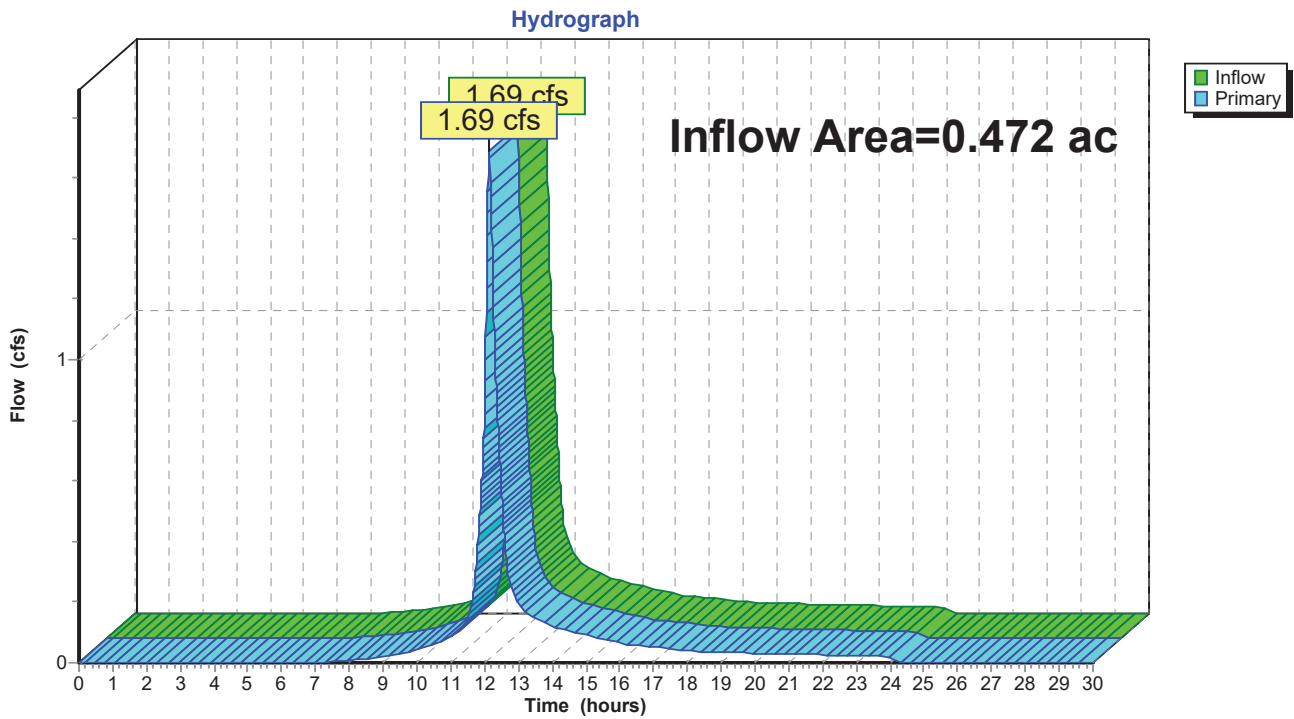

### Summary for Link POA 2: POA 2

Inflow Area = 0.441 ac, 6.08% Impervious, Inflow Depth = 2.67" for 10 YEAR STORM event  
Inflow = 1.23 cfs @ 12.13 hrs, Volume= 0.098 af  
Primary = 1.23 cfs @ 12.13 hrs, Volume= 0.098 af, Atten= 0%, Lag= 0.0 min

Primary outflow = Inflow, Time Span= 0.00-30.00 hrs, dt= 0.01 hrs

### Link POA 2: POA 2

Hydrograph

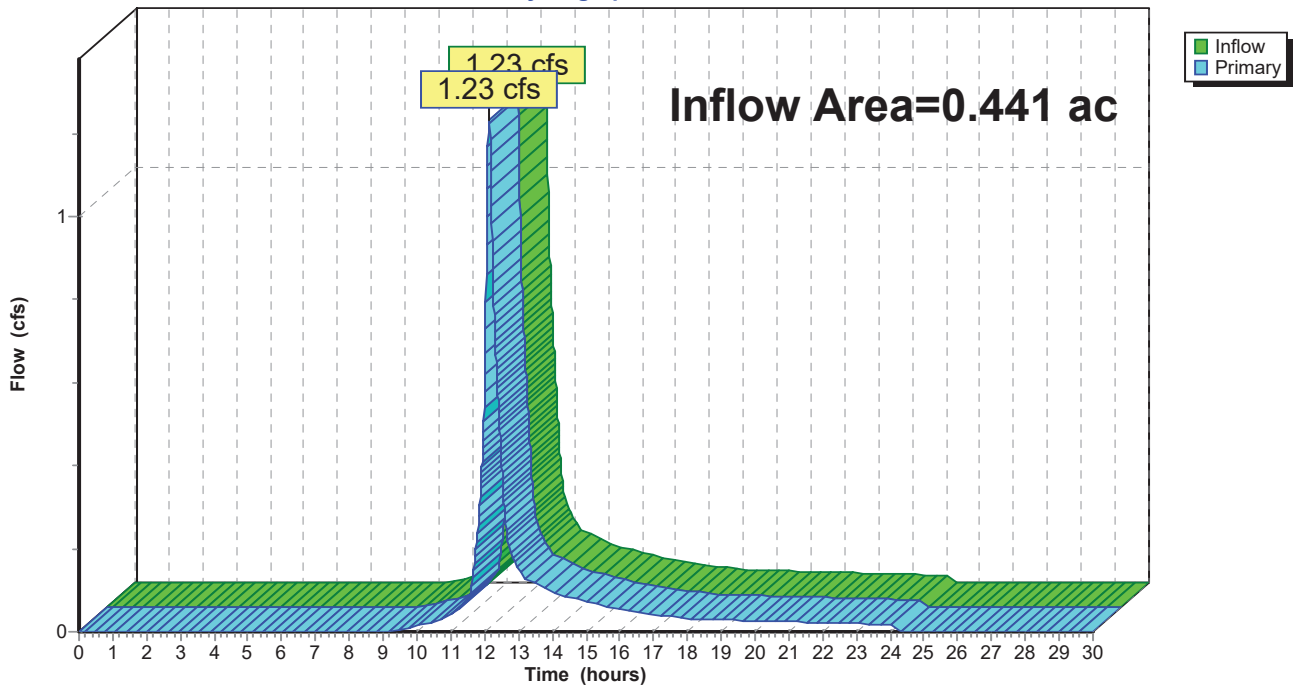

### Summary for Link POA 3: Wetland

Inflow Area = 0.571 ac, 9.30% Impervious, Inflow Depth = 2.85" for 10 YEAR STORM event  
Inflow = 1.63 cfs @ 12.15 hrs, Volume= 0.136 af  
Primary = 1.63 cfs @ 12.15 hrs, Volume= 0.136 af, Atten= 0%, Lag= 0.0 min

Primary outflow = Inflow, Time Span= 0.00-30.00 hrs, dt= 0.01 hrs

### Link POA 3: Wetland

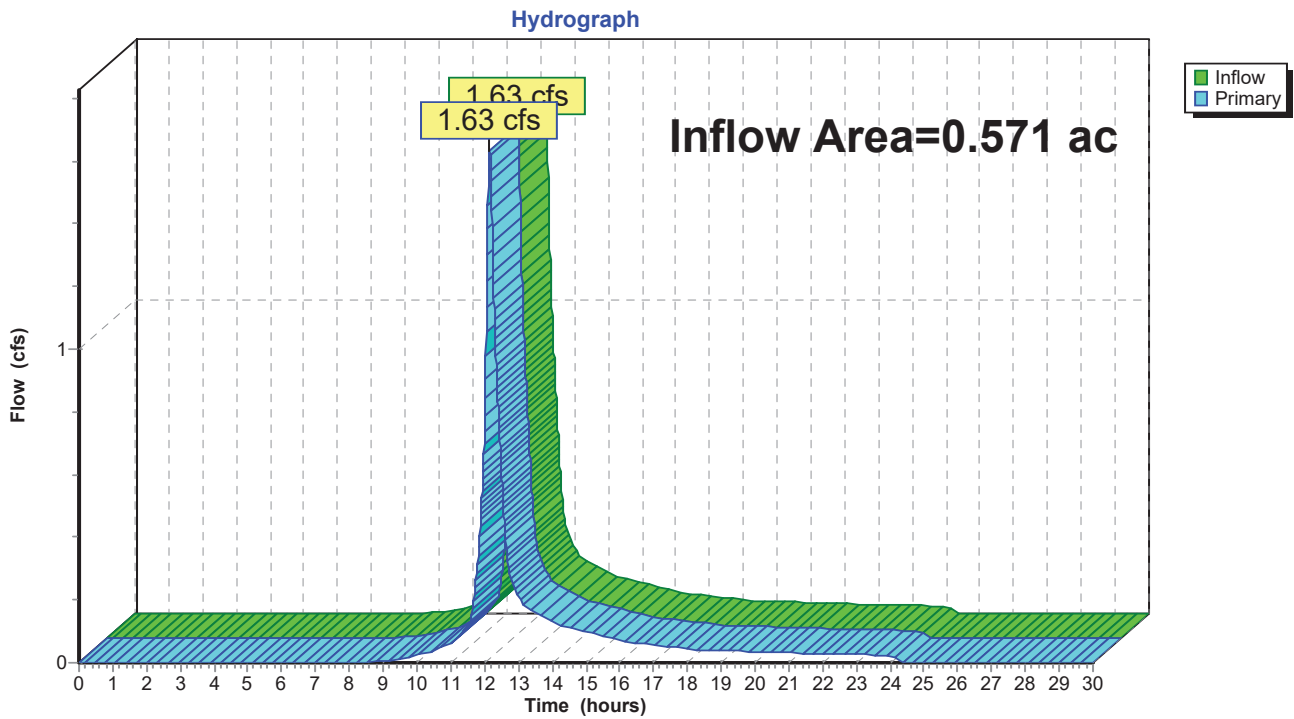

### Summary for Link POA 4: POA 4

Inflow Area = 0.042 ac, 4.79% Impervious, Inflow Depth = 2.58" for 10 YEAR STORM event  
Inflow = 0.13 cfs @ 12.09 hrs, Volume= 0.009 af  
Primary = 0.13 cfs @ 12.09 hrs, Volume= 0.009 af, Atten= 0%, Lag= 0.0 min

Primary outflow = Inflow, Time Span= 0.00-30.00 hrs, dt= 0.01 hrs

### Link POA 4: POA 4

Hydrograph

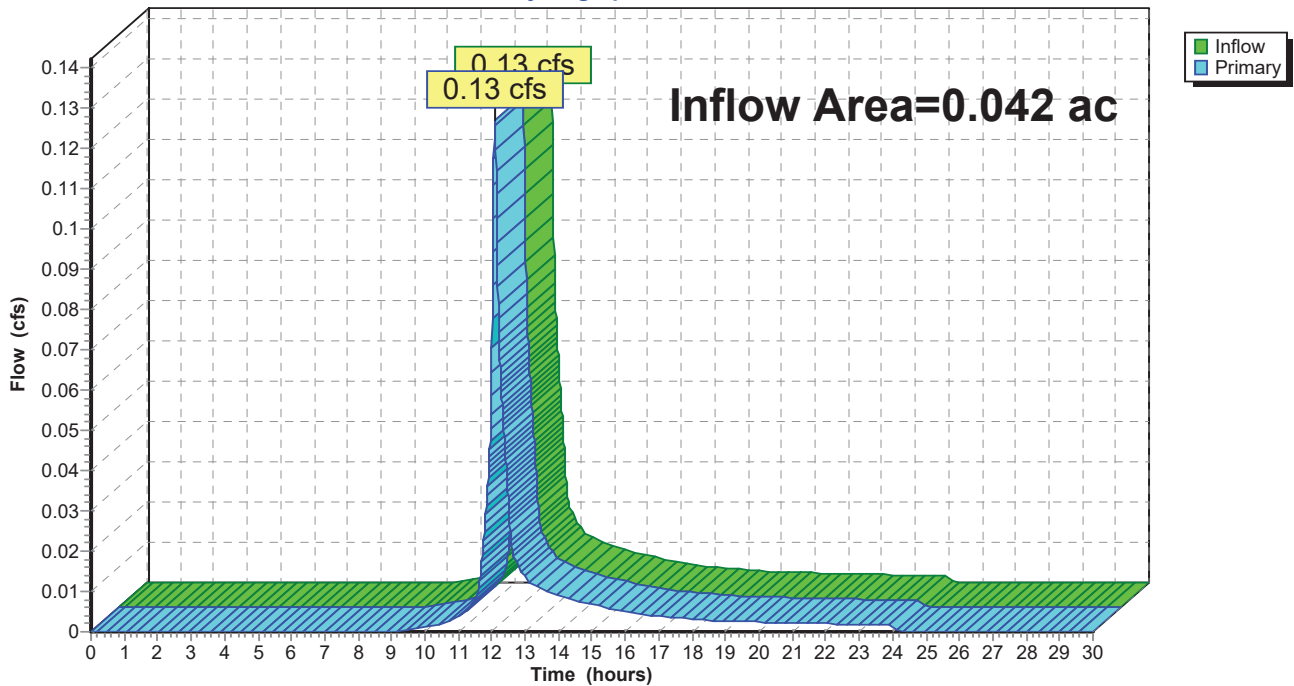

Time span=0.00-30.00 hrs, dt=0.01 hrs, 3001 points  
Runoff by SCS TR-20 method, UH=SCS, Weighted-CN  
Reach routing by Dyn-Stor-Ind method - Pond routing by Dyn-Stor-Ind method

**Subcatchment 1S: SW Corner** Runoff Area=20,575 sf 31.17% Impervious Runoff Depth=1.87"  
Flow Length=184' Tc=10.2 min CN=81 Runoff=0.90 cfs 0.074 af

**Subcatchment 2S: SE Corner** Runoff Area=19,202 sf 6.08% Impervious Runoff Depth=1.25"  
Flow Length=265' Tc=9.1 min CN=72 Runoff=0.55 cfs 0.046 af

**Subcatchment 3S: N Central** Runoff Area=24,854 sf 9.30% Impervious Runoff Depth=1.38"  
Flow Length=160' Tc=10.6 min CN=74 Runoff=0.76 cfs 0.066 af

**Subcatchment S4: NE Corner** Runoff Area=1,838 sf 4.79% Impervious Runoff Depth=1.19"  
Flow Length=122' Tc=6.0 min CN=71 Runoff=0.06 cfs 0.004 af

**Link POA 1: City System** Inflow=0.90 cfs 0.074 af  
Primary=0.90 cfs 0.074 af

**Link POA 2: POA 2** Inflow=0.55 cfs 0.046 af  
Primary=0.55 cfs 0.046 af

**Link POA 3: Wetland** Inflow=0.76 cfs 0.066 af  
Primary=0.76 cfs 0.066 af

**Link POA 4: POA 4** Inflow=0.06 cfs 0.004 af  
Primary=0.06 cfs 0.004 af

**Total Runoff Area = 1.526 ac Runoff Volume = 0.190 af Average Runoff Depth = 1.49"**  
**84.98% Pervious = 1.297 ac 15.02% Impervious = 0.229 ac**

Time span=0.00-30.00 hrs, dt=0.01 hrs, 3001 points  
Runoff by SCS TR-20 method, UH=SCS, Weighted-CN  
Reach routing by Dyn-Stor-Ind method - Pond routing by Dyn-Stor-Ind method

**Subcatchment 1S: SW Corner** Runoff Area=20,575 sf 31.17% Impervious Runoff Depth=4.92"  
Flow Length=184' Tc=10.2 min CN=81 Runoff=2.34 cfs 0.194 af

**Subcatchment 2S: SE Corner** Runoff Area=19,202 sf 6.08% Impervious Runoff Depth=3.93"  
Flow Length=265' Tc=9.1 min CN=72 Runoff=1.83 cfs 0.144 af

**Subcatchment 3S: N Central** Runoff Area=24,854 sf 9.30% Impervious Runoff Depth=4.15"  
Flow Length=160' Tc=10.6 min CN=74 Runoff=2.38 cfs 0.197 af

**Subcatchment S4: NE Corner** Runoff Area=1,838 sf 4.79% Impervious Runoff Depth=3.82"  
Flow Length=122' Tc=6.0 min CN=71 Runoff=0.19 cfs 0.013 af

**Link POA 1: City System** Inflow=2.34 cfs 0.194 af  
Primary=2.34 cfs 0.194 af

**Link POA 2: POA 2** Inflow=1.83 cfs 0.144 af  
Primary=1.83 cfs 0.144 af

**Link POA 3: Wetland** Inflow=2.38 cfs 0.197 af  
Primary=2.38 cfs 0.197 af

**Link POA 4: POA 4** Inflow=0.19 cfs 0.013 af  
Primary=0.19 cfs 0.013 af

**Total Runoff Area = 1.526 ac Runoff Volume = 0.549 af Average Runoff Depth = 4.31"**  
**84.98% Pervious = 1.297 ac 15.02% Impervious = 0.229 ac**

Time span=0.00-30.00 hrs, dt=0.01 hrs, 3001 points  
Runoff by SCS TR-20 method, UH=SCS, Weighted-CN  
Reach routing by Dyn-Stor-Ind method - Pond routing by Dyn-Stor-Ind method

**Subcatchment 1S: SW Corner** Runoff Area=20,575 sf 31.17% Impervious Runoff Depth=6.22"  
Flow Length=184' Tc=10.2 min CN=81 Runoff=2.93 cfs 0.245 af

**Subcatchment 2S: SE Corner** Runoff Area=19,202 sf 6.08% Impervious Runoff Depth=5.14"  
Flow Length=265' Tc=9.1 min CN=72 Runoff=2.39 cfs 0.189 af

**Subcatchment 3S: N Central** Runoff Area=24,854 sf 9.30% Impervious Runoff Depth=5.38"  
Flow Length=160' Tc=10.6 min CN=74 Runoff=3.08 cfs 0.256 af

**Subcatchment S4: NE Corner** Runoff Area=1,838 sf 4.79% Impervious Runoff Depth=5.03"  
Flow Length=122' Tc=6.0 min CN=71 Runoff=0.25 cfs 0.018 af

**Link POA 1: City System** Inflow=2.93 cfs 0.245 af  
Primary=2.93 cfs 0.245 af

**Link POA 2: POA 2** Inflow=2.39 cfs 0.189 af  
Primary=2.39 cfs 0.189 af

**Link POA 3: Wetland** Inflow=3.08 cfs 0.256 af  
Primary=3.08 cfs 0.256 af

**Link POA 4: POA 4** Inflow=0.25 cfs 0.018 af  
Primary=0.25 cfs 0.018 af

**Total Runoff Area = 1.526 ac Runoff Volume = 0.708 af Average Runoff Depth = 5.57"**  
**84.98% Pervious = 1.297 ac 15.02% Impervious = 0.229 ac**

## Section 4

# Drainage Calculations

Post-Development

2-Year, 24-Hour Summary

10-Year, 24-Hour Complete

25-Year, 24-Hour Summary

50-Year, 24-Hour Summary



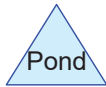
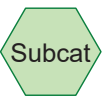
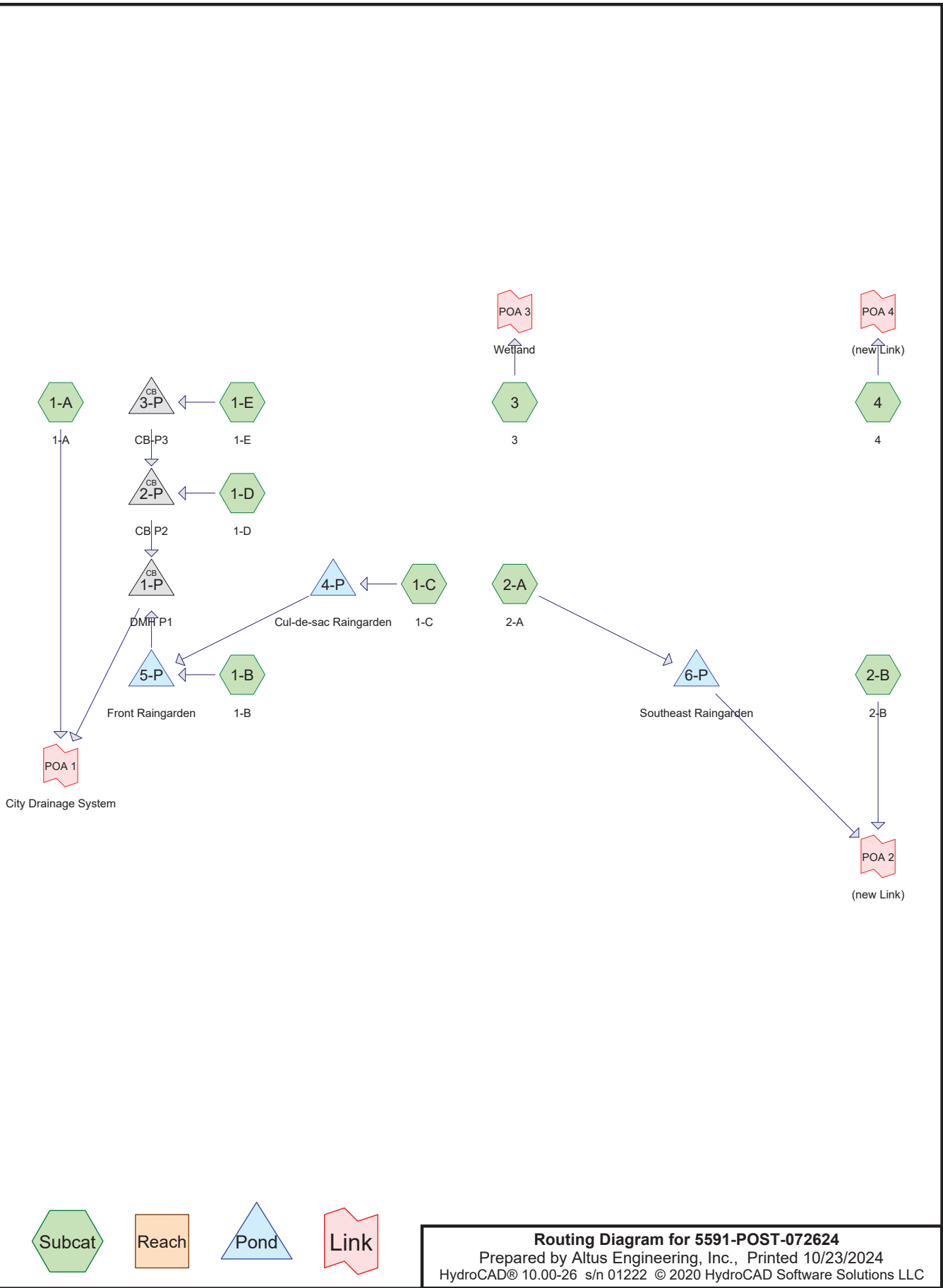

**Routing Diagram for 5591-POST-072624**  
 Prepared by Altus Engineering, Inc., Printed 10/23/2024  
 HydroCAD® 10.00-26 s/n 01222 © 2020 HydroCAD Software Solutions LLC

**Area Listing (all nodes)**

Area (acres)	CN	Description (subcatchment-numbers)
0.902	74	>75% Grass cover, Good, HSG C (1-A, 1-B, 1-C, 1-D, 1-E, 2-A, 2-B, 3, 4)
0.321	98	Paved parking, HSG C (1-A, 1-C, 1-D, 1-E, 2-A, 2-B, 4)
0.162	98	Roofs, HSG C (1-B, 1-D, 2-A, 3)
0.124	70	Woods, Good, HSG C (2-A, 2-B, 3, 4)
0.018	79	Woods/grass comb., Good, HSG D (3)
<b>1.526</b>	<b>81</b>	<b>TOTAL AREA</b>

**5591-POST-072624**

Prepared by Altus Engineering, Inc.

HydroCAD® 10.00-26 s/n 01222 © 2020 HydroCAD Software Solutions LLC

Printed 10/23/2024

Page 19

**Soil Listing (all nodes)**

Area (acres)	Soil Group	Subcatchment Numbers
0.000	HSG A	
0.000	HSG B	
1.508	HSG C	1-A, 1-B, 1-C, 1-D, 1-E, 2-A, 2-B, 3, 4
0.018	HSG D	3
0.000	Other	
<b>1.526</b>		<b>TOTAL AREA</b>

**5591-POST-072624**

Prepared by Altus Engineering, Inc.

Printed 10/23/2024

HydroCAD® 10.00-26 s/n 01222 © 2020 HydroCAD Software Solutions LLC

Page 20

**Ground Covers (all nodes)**

HSG-A (acres)	HSG-B (acres)	HSG-C (acres)	HSG-D (acres)	Other (acres)	Total (acres)	Ground Cover	Subcatchment Numbers
0.000	0.000	0.902	0.000	0.000	0.902	>75% Grass cover, Good	1-A, 1-B, 1-C, 1-D, 1-E, 2-A, 2-B, 3, 4
0.000	0.000	0.321	0.000	0.000	0.321	Paved parking	1-A, 1-C, 1-D, 1-E, 2-A, 2-B, 4
0.000	0.000	0.162	0.000	0.000	0.162	Roofs	1-B, 1-D, 2-A, 3
0.000	0.000	0.124	0.000	0.000	0.124	Woods, Good	2-A, 2-B, 3, 4
0.000	0.000	0.000	0.018	0.000	0.018	Woods/grass comb., Good	3
<b>0.000</b>	<b>0.000</b>	<b>1.508</b>	<b>0.018</b>	<b>0.000</b>	<b>1.526</b>	<b>TOTAL AREA</b>	

Time span=0.00-30.00 hrs, dt=0.01 hrs, 3001 points  
 Runoff by SCS TR-20 method, UH=SCS, Weighted-CN  
 Reach routing by Dyn-Stor-Ind method - Pond routing by Dyn-Stor-Ind method

<b>Subcatchment 1-A: 1-A</b>	Runoff Area=4,099 sf 78.87% Impervious Runoff Depth=4.79" Tc=6.0 min CN=93 Runoff=0.49 cfs 0.038 af
<b>Subcatchment 1-B: 1-B</b>	Runoff Area=11,993 sf 17.73% Impervious Runoff Depth=3.23" Flow Length=90' Tc=6.0 min CN=78 Runoff=1.04 cfs 0.074 af
<b>Subcatchment 1-C: 1-C</b>	Runoff Area=11,062 sf 65.89% Impervious Runoff Depth=4.46" Tc=6.0 min CN=90 Runoff=1.27 cfs 0.094 af
<b>Subcatchment 1-D: 1-D</b>	Runoff Area=4,631 sf 40.44% Impervious Runoff Depth=3.82" Flow Length=135' Tc=6.0 min CN=84 Runoff=0.47 cfs 0.034 af
<b>Subcatchment 1-E: 1-E</b>	Runoff Area=1,957 sf 48.90% Impervious Runoff Depth=4.03" Tc=6.0 min CN=86 Runoff=0.21 cfs 0.015 af
<b>Subcatchment 2-A: 2-A</b>	Runoff Area=21,222 sf 23.11% Impervious Runoff Depth=3.32" Flow Length=188' Tc=8.1 min CN=79 Runoff=1.76 cfs 0.135 af
<b>Subcatchment 2-B: 2-B</b>	Runoff Area=6,257 sf 0.48% Impervious Runoff Depth=2.67" Flow Length=145' Tc=6.0 min CN=72 Runoff=0.45 cfs 0.032 af
<b>Subcatchment 3: 3</b>	Runoff Area=3,462 sf 16.09% Impervious Runoff Depth=3.32" Tc=6.0 min CN=79 Runoff=0.31 cfs 0.022 af
<b>Subcatchment 4: 4</b>	Runoff Area=1,786 sf 3.02% Impervious Runoff Depth=2.76" Flow Length=122' Tc=7.2 min CN=73 Runoff=0.13 cfs 0.009 af
<b>Pond 1-P: DMH P1</b>	Peak Elev=53.27' Inflow=0.84 cfs 0.217 af 12.0" Round Culvert n=0.012 L=33.0' S=0.0052 '/' Outflow=0.84 cfs 0.217 af
<b>Pond 2-P: CB P2</b>	Peak Elev=53.39' Inflow=0.68 cfs 0.049 af 12.0" Round Culvert n=0.012 L=4.0' S=0.0050 '/' Outflow=0.68 cfs 0.049 af
<b>Pond 3-P: CB-P3</b>	Peak Elev=53.44' Inflow=0.21 cfs 0.015 af 12.0" Round Culvert n=0.012 L=23.0' S=0.0052 '/' Outflow=0.21 cfs 0.015 af
<b>Pond 4-P: Cul-de-sac Raingarden</b>	Peak Elev=61.65' Storage=471 cf Inflow=1.27 cfs 0.094 af Outflow=1.25 cfs 0.094 af
<b>Pond 5-P: Front Raingarden</b>	Peak Elev=59.54' Storage=2,847 cf Inflow=2.28 cfs 0.168 af Outflow=0.26 cfs 0.168 af
<b>Pond 6-P: Southeast Raingarden</b>	Peak Elev=60.14' Storage=1,826 cf Inflow=1.76 cfs 0.135 af Outflow=0.70 cfs 0.129 af
<b>Link POA 1: City Drainage System</b>	Inflow=1.33 cfs 0.255 af Primary=1.33 cfs 0.255 af

**5591-POST-072624**

Type III 24-hr 10 YEAR STORM Rainfall=5.60"

Prepared by Altus Engineering, Inc.

Printed 10/23/2024

HydroCAD® 10.00-26 s/n 01222 © 2020 HydroCAD Software Solutions LLC

Page 22

**Link POA 2: (new Link)**

Inflow=0.98 cfs 0.161 af  
Primary=0.98 cfs 0.161 af

**Link POA 3: Wetland**

Inflow=0.31 cfs 0.022 af  
Primary=0.31 cfs 0.022 af

**Link POA 4: (new Link)**

Inflow=0.13 cfs 0.009 af  
Primary=0.13 cfs 0.009 af

**Total Runoff Area = 1.526 ac   Runoff Volume = 0.453 af   Average Runoff Depth = 3.56"**  
**68.37% Pervious = 1.043 ac   31.63% Impervious = 0.483 ac**

**Summary for Subcatchment 1-A: 1-A**

Runoff = 0.49 cfs @ 12.08 hrs, Volume= 0.038 af, Depth= 4.79"

Runoff by SCS TR-20 method, UH=SCS, Weighted-CN, Time Span= 0.00-30.00 hrs, dt= 0.01 hrs  
 Type III 24-hr 10 YEAR STORM Rainfall=5.60"

Area (sf)	CN	Description
3,233	98	Paved parking, HSG C
866	74	>75% Grass cover, Good, HSG C
4,099	93	Weighted Average
866		21.13% Pervious Area
3,233		78.87% Impervious Area

Tc (min)	Length (feet)	Slope (ft/ft)	Velocity (ft/sec)	Capacity (cfs)	Description
6.0					Direct Entry,

**Subcatchment 1-A: 1-A**

Hydrograph

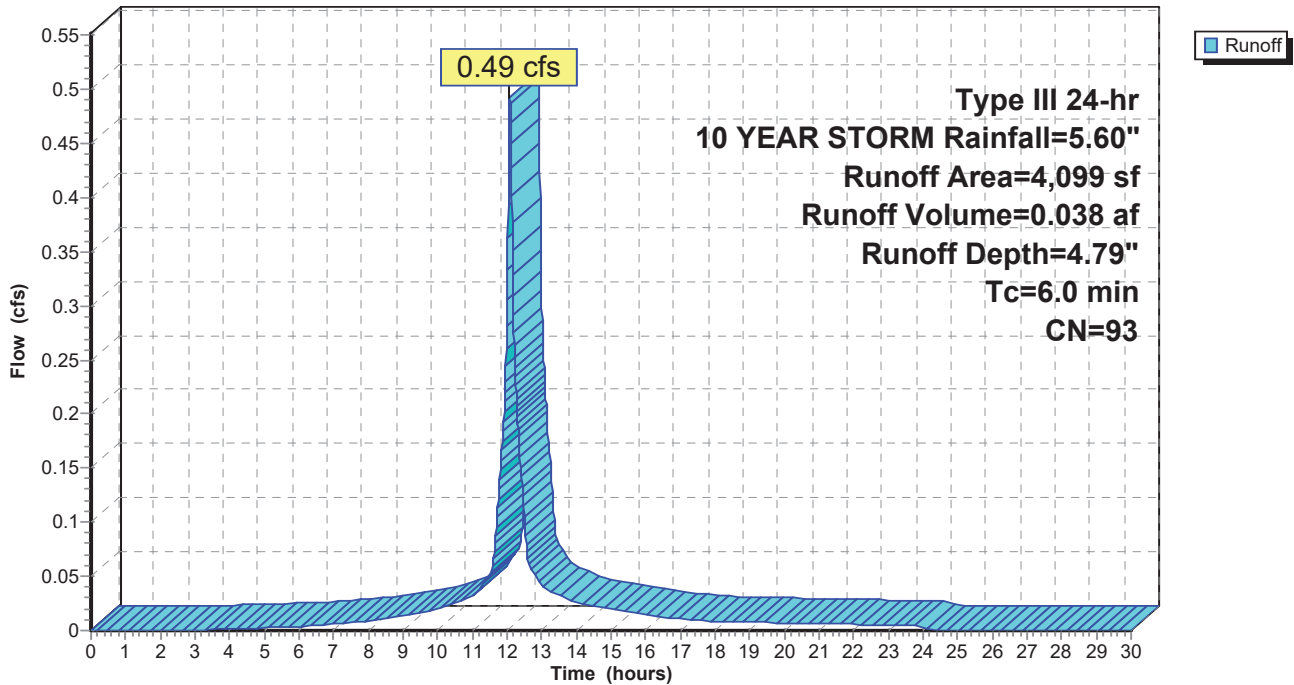

**Summary for Subcatchment 1-B: 1-B**

Runoff = 1.04 cfs @ 12.09 hrs, Volume= 0.074 af, Depth= 3.23"

Runoff by SCS TR-20 method, UH=SCS, Weighted-CN, Time Span= 0.00-30.00 hrs, dt= 0.01 hrs  
 Type III 24-hr 10 YEAR STORM Rainfall=5.60"

Area (sf)	CN	Description
2,126	98	Roofs, HSG C
9,867	74	>75% Grass cover, Good, HSG C
11,993	78	Weighted Average
9,867		82.27% Pervious Area
2,126		17.73% Impervious Area

Tc (min)	Length (feet)	Slope (ft/ft)	Velocity (ft/sec)	Capacity (cfs)	Description
3.6	50	0.0600	0.23		Sheet Flow, Grass: Short n= 0.150 P2= 3.23"
0.3	40	0.0050	2.05	16.41	Trap/Vee/Rect Channel Flow, Bot.W=2.00' D=1.00' Z= 6.0 ' /' Top.W=14.00' n= 0.035 Earth, dense weeds
2.1					Direct Entry,
6.0	90	Total			

**Subcatchment 1-B: 1-B**

Hydrograph

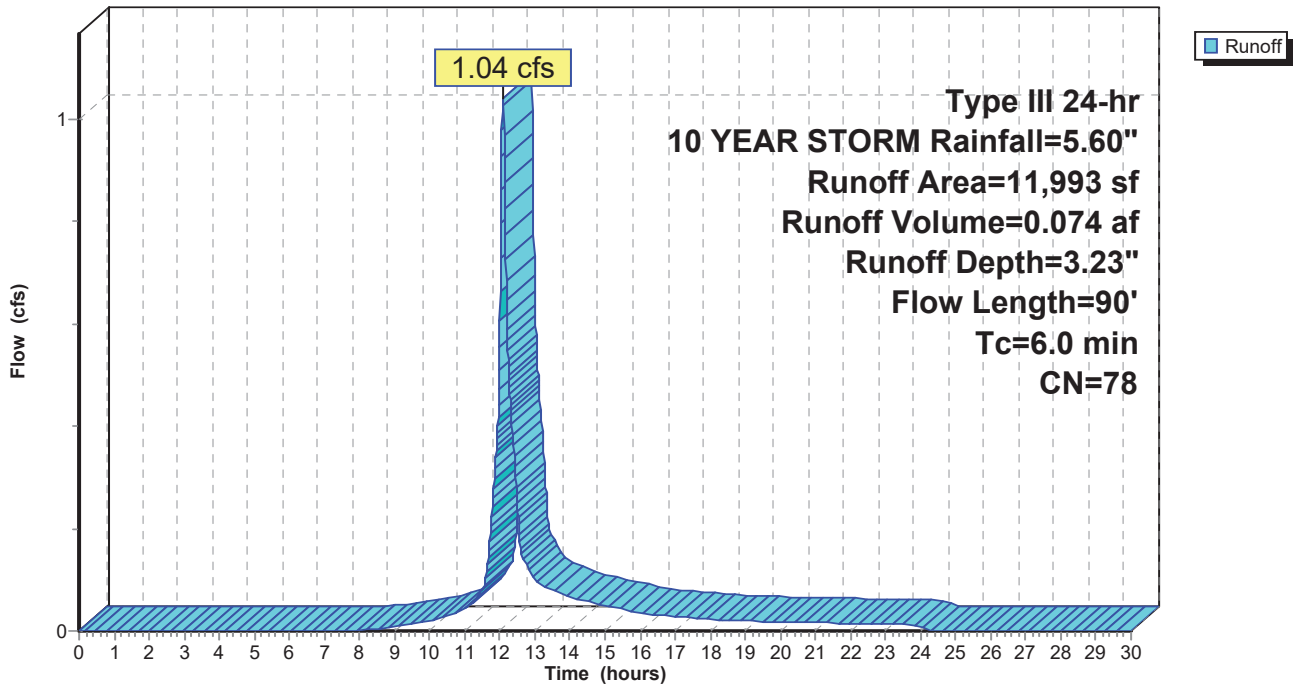



**Summary for Subcatchment 1-C: 1-C**

Runoff = 1.27 cfs @ 12.08 hrs, Volume= 0.094 af, Depth= 4.46"

Runoff by SCS TR-20 method, UH=SCS, Weighted-CN, Time Span= 0.00-30.00 hrs, dt= 0.01 hrs  
 Type III 24-hr 10 YEAR STORM Rainfall=5.60"

Area (sf)	CN	Description
7,289	98	Paved parking, HSG C
3,773	74	>75% Grass cover, Good, HSG C
11,062	90	Weighted Average
3,773		34.11% Pervious Area
7,289		65.89% Impervious Area

Tc (min)	Length (feet)	Slope (ft/ft)	Velocity (ft/sec)	Capacity (cfs)	Description
6.0					Direct Entry,

**Subcatchment 1-C: 1-C**

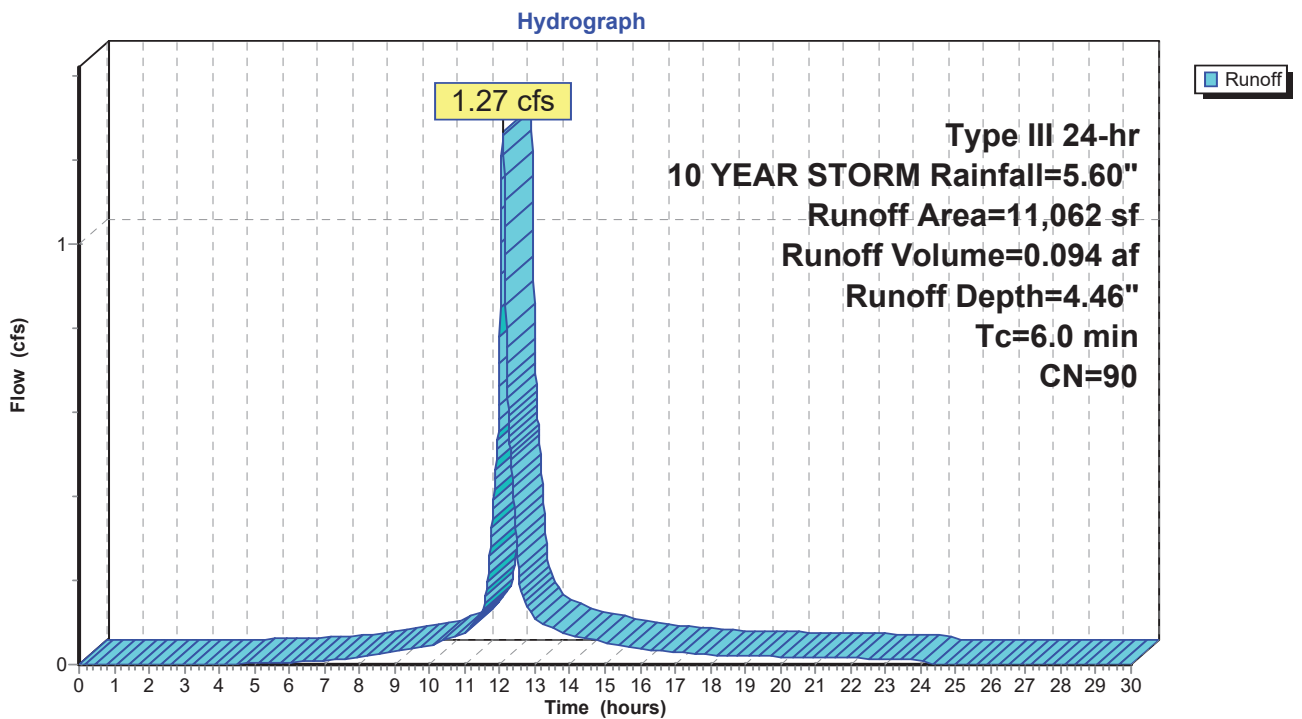

**Summary for Subcatchment 1-D: 1-D**

Runoff = 0.47 cfs @ 12.09 hrs, Volume= 0.034 af, Depth= 3.82"

Runoff by SCS TR-20 method, UH=SCS, Weighted-CN, Time Span= 0.00-30.00 hrs, dt= 0.01 hrs  
 Type III 24-hr 10 YEAR STORM Rainfall=5.60"

Area (sf)	CN	Description
14	98	Roofs, HSG C
1,859	98	Paved parking, HSG C
2,758	74	>75% Grass cover, Good, HSG C
4,631	84	Weighted Average
2,758		59.56% Pervious Area
1,873		40.44% Impervious Area

Tc (min)	Length (feet)	Slope (ft/ft)	Velocity (ft/sec)	Capacity (cfs)	Description
3.6	42	0.0430	0.20		<b>Sheet Flow,</b> Grass: Short n= 0.150 P2= 3.23"
0.4	36	0.0420	1.43		<b>Shallow Concentrated Flow,</b> Short Grass Pasture Kv= 7.0 fps
0.2	57	0.0550	4.76		<b>Shallow Concentrated Flow,</b> Paved Kv= 20.3 fps
1.8					<b>Direct Entry,</b>
6.0	135	Total			

**Subcatchment 1-D: 1-D**

Hydrograph

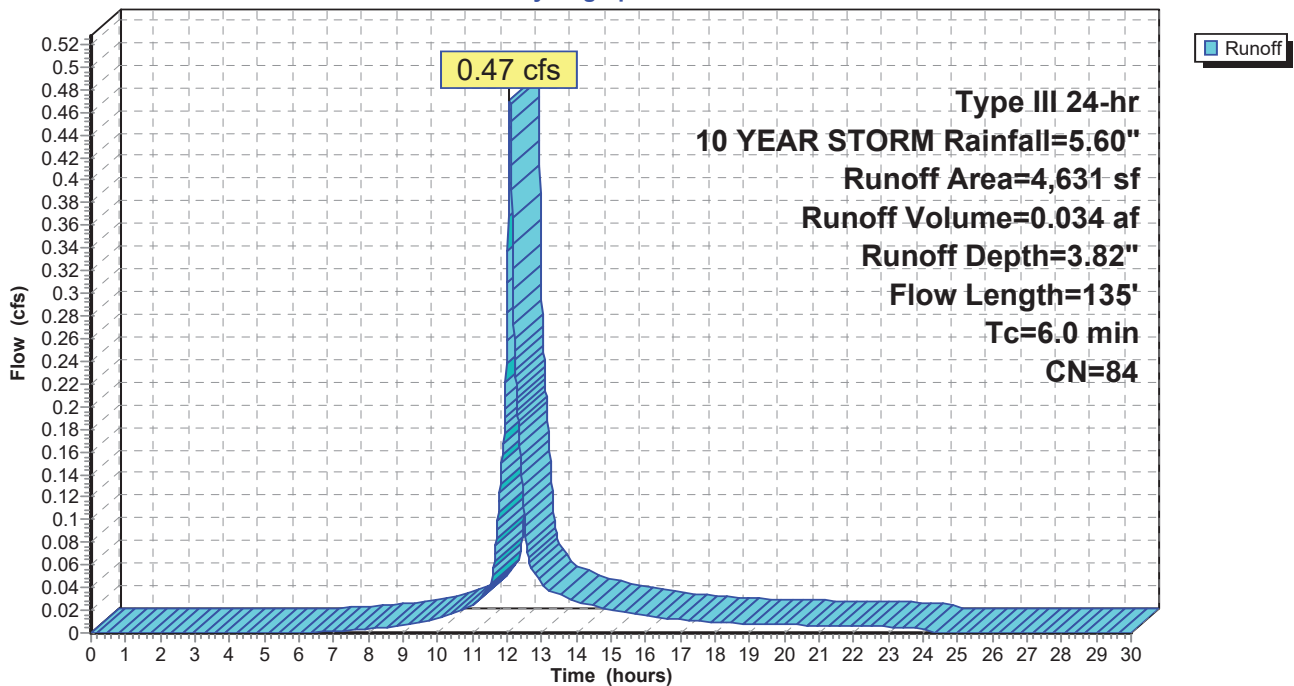

**Summary for Subcatchment 1-E: 1-E**

Runoff = 0.21 cfs @ 12.09 hrs, Volume= 0.015 af, Depth= 4.03"

Runoff by SCS TR-20 method, UH=SCS, Weighted-CN, Time Span= 0.00-30.00 hrs, dt= 0.01 hrs  
 Type III 24-hr 10 YEAR STORM Rainfall=5.60"

Area (sf)	CN	Description
957	98	Paved parking, HSG C
1,000	74	>75% Grass cover, Good, HSG C
1,957	86	Weighted Average
1,000		51.10% Pervious Area
957		48.90% Impervious Area

Tc (min)	Length (feet)	Slope (ft/ft)	Velocity (ft/sec)	Capacity (cfs)	Description
6.0					Direct Entry,

**Subcatchment 1-E: 1-E**

Hydrograph

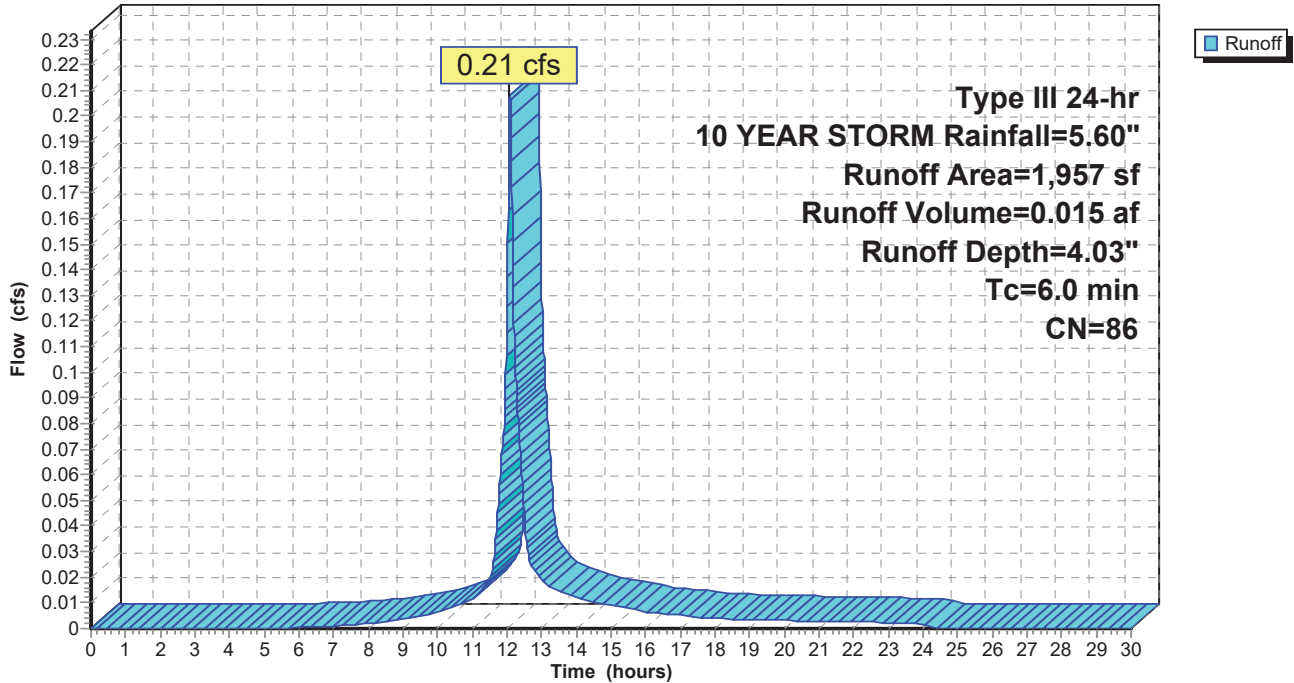

**Summary for Subcatchment 2-A: 2-A**

Runoff = 1.76 cfs @ 12.12 hrs, Volume= 0.135 af, Depth= 3.32"

Runoff by SCS TR-20 method, UH=SCS, Weighted-CN, Time Span= 0.00-30.00 hrs, dt= 0.01 hrs  
 Type III 24-hr 10 YEAR STORM Rainfall=5.60"

Area (sf)	CN	Description
4,354	98	Roofs, HSG C
551	98	Paved parking, HSG C
510	70	Woods, Good, HSG C
15,807	74	>75% Grass cover, Good, HSG C
21,222	79	Weighted Average
16,317		76.89% Pervious Area
4,905		23.11% Impervious Area

Tc (min)	Length (feet)	Slope (ft/ft)	Velocity (ft/sec)	Capacity (cfs)	Description
6.5	33	0.0060	0.08		<b>Sheet Flow,</b> Grass: Short n= 0.150 P2= 3.23"
1.0	38	0.0090	0.66		<b>Shallow Concentrated Flow,</b> Short Grass Pasture Kv= 7.0 fps
0.4	77	0.0130	3.21	16.07	<b>Trap/Vee/Rect Channel Flow,</b> Bot.W=1.00' D=1.00' Z= 4.0 ' Top.W=9.00' n= 0.035 Earth, dense weeds
0.2	40	0.0812	4.37	21.84	<b>Trap/Vee/Rect Channel Flow,</b> Bot.W=2.00' D=1.00' Z= 3.0 ' Top.W=8.00' n= 0.069 Riprap, 6-inch
8.1	188	Total			

### Subcatchment 2-A: 2-A

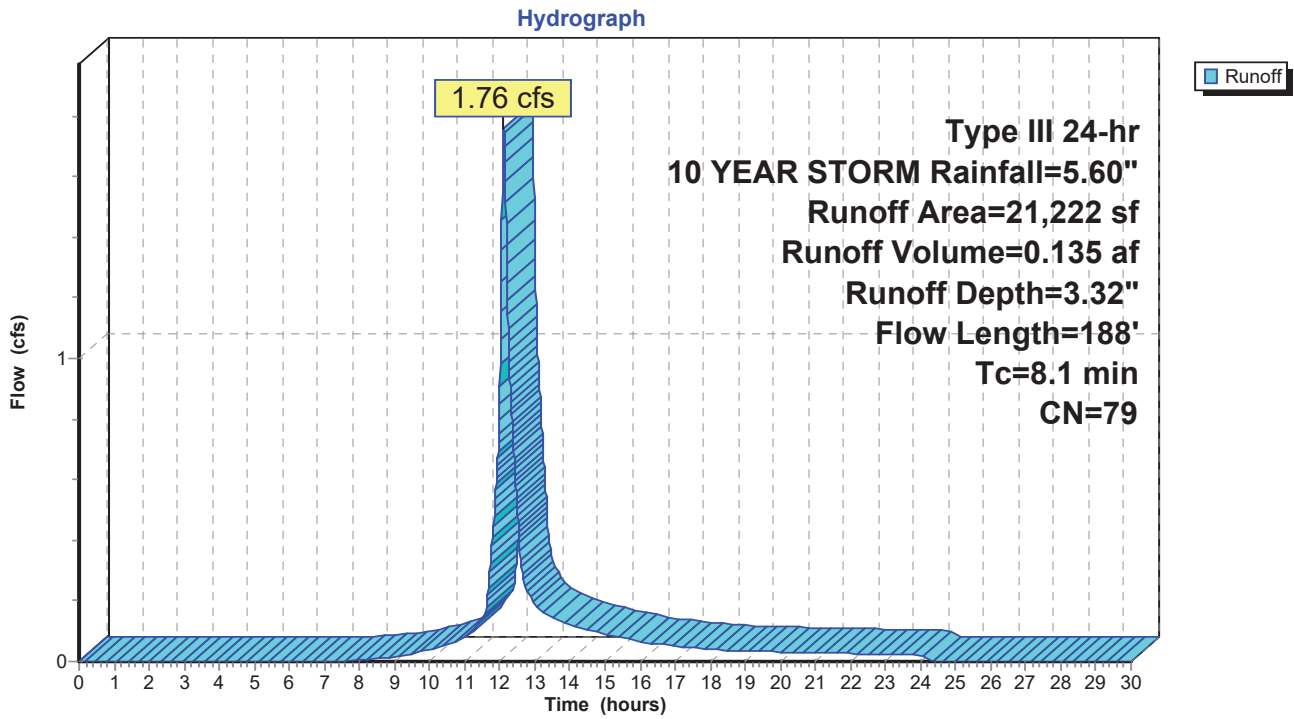

### Summary for Subcatchment 2-B: 2-B

Runoff = 0.45 cfs @ 12.09 hrs, Volume= 0.032 af, Depth= 2.67"

Runoff by SCS TR-20 method, UH=SCS, Weighted-CN, Time Span= 0.00-30.00 hrs, dt= 0.01 hrs  
Type III 24-hr 10 YEAR STORM Rainfall=5.60"

Area (sf)	CN	Description
30	98	Paved parking, HSG C
3,925	70	Woods, Good, HSG C
2,302	74	>75% Grass cover, Good, HSG C
6,257	72	Weighted Average
6,227		99.52% Pervious Area
30		0.48% Impervious Area

Tc (min)	Length (feet)	Slope (ft/ft)	Velocity (ft/sec)	Capacity (cfs)	Description
3.3	45	0.0600	0.23		<b>Sheet Flow,</b> Grass: Short n= 0.150 P2= 3.23"
1.5	100	0.0500	1.12		<b>Shallow Concentrated Flow,</b> Woodland Kv= 5.0 fps
1.2					<b>Direct Entry,</b>
6.0	145	Total			

### Subcatchment 2-B: 2-B

Hydrograph

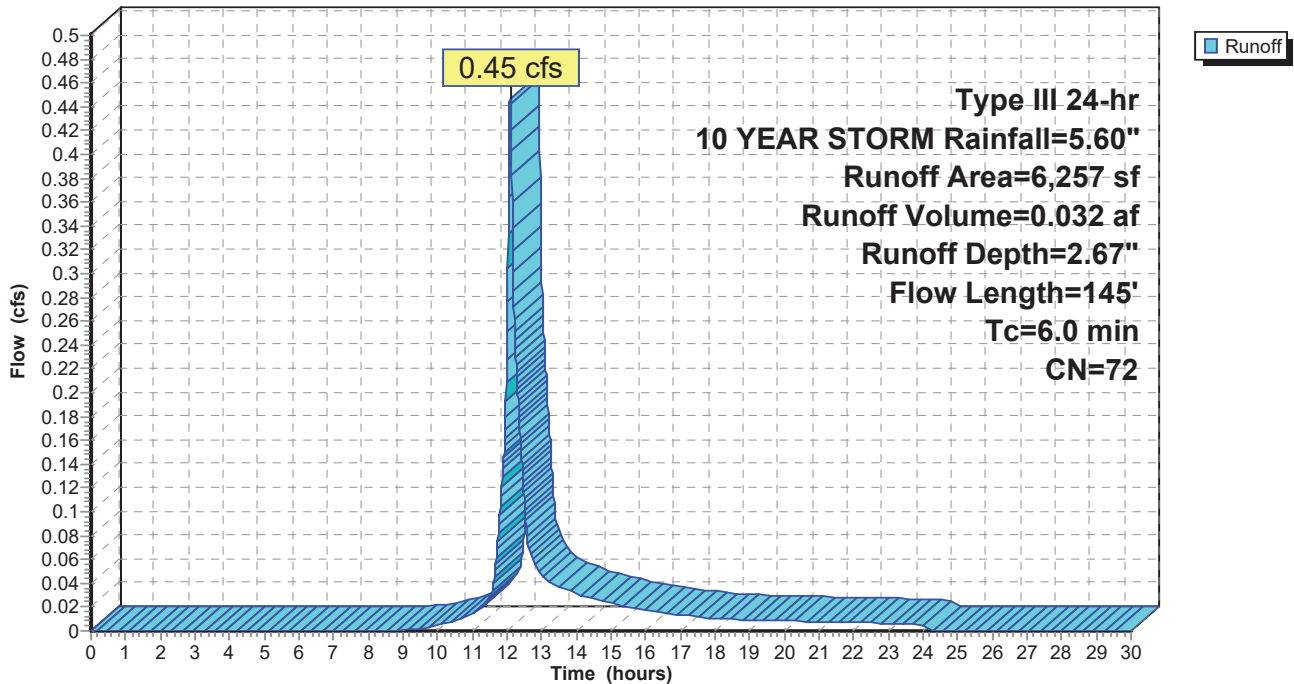

### Summary for Subcatchment 3: 3

Runoff = 0.31 cfs @ 12.09 hrs, Volume= 0.022 af, Depth= 3.32"

Runoff by SCS TR-20 method, UH=SCS, Weighted-CN, Time Span= 0.00-30.00 hrs, dt= 0.01 hrs  
 Type III 24-hr 10 YEAR STORM Rainfall=5.60"

Area (sf)	CN	Description
557	98	Roofs, HSG C
781	79	Woods/grass comb., Good, HSG D
201	70	Woods, Good, HSG C
1,923	74	>75% Grass cover, Good, HSG C
3,462	79	Weighted Average
2,905		83.91% Pervious Area
557		16.09% Impervious Area

Tc (min)	Length (feet)	Slope (ft/ft)	Velocity (ft/sec)	Capacity (cfs)	Description
6.0					Direct Entry,

### Subcatchment 3: 3

Hydrograph

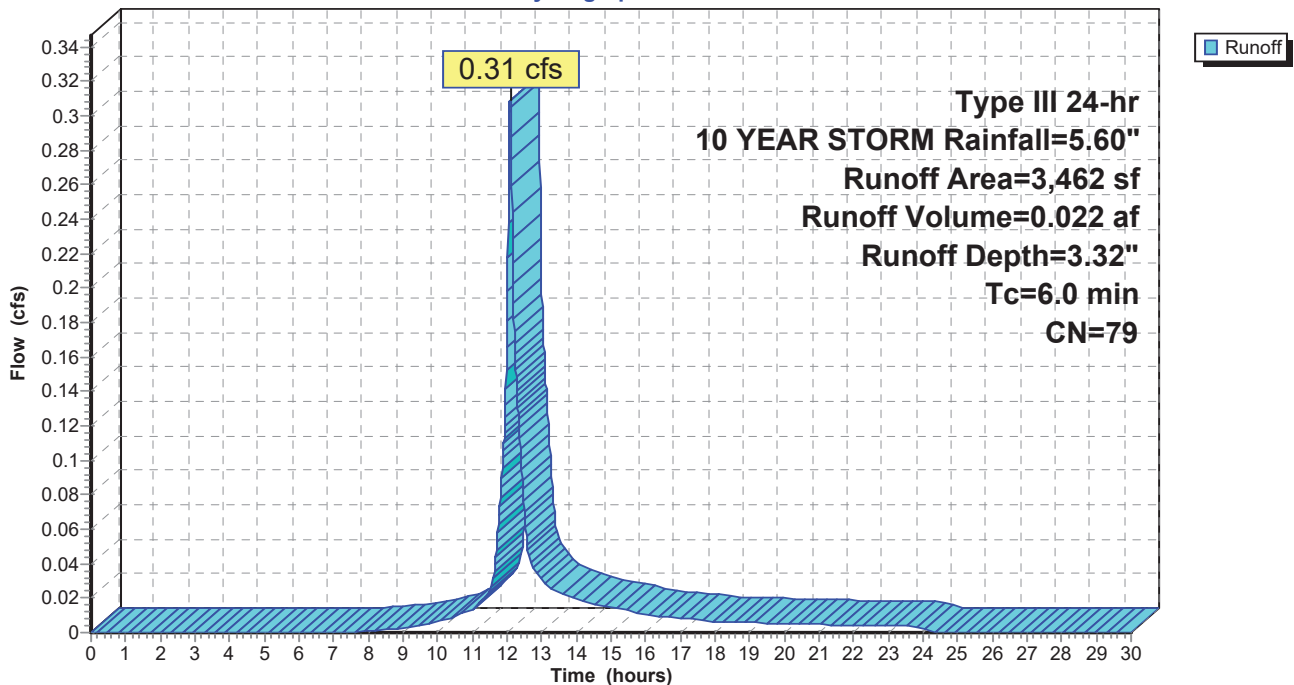

### Summary for Subcatchment 4: 4

Runoff = 0.13 cfs @ 12.11 hrs, Volume= 0.009 af, Depth= 2.76"

Runoff by SCS TR-20 method, UH=SCS, Weighted-CN, Time Span= 0.00-30.00 hrs, dt= 0.01 hrs  
 Type III 24-hr 10 YEAR STORM Rainfall=5.60"

Area (sf)	CN	Description
54	98	Paved parking, HSG C
750	70	Woods, Good, HSG C
982	74	>75% Grass cover, Good, HSG C
1,786	73	Weighted Average
1,732		96.98% Pervious Area
54		3.02% Impervious Area

Tc (min)	Length (feet)	Slope (ft/ft)	Velocity (ft/sec)	Capacity (cfs)	Description
6.2	43	0.0814	0.12		<b>Sheet Flow,</b> Woods: Light underbrush n= 0.400 P2= 3.23"
1.0	79	0.0696	1.32		<b>Shallow Concentrated Flow,</b> Woodland Kv= 5.0 fps
7.2	122	Total			

### Subcatchment 4: 4

Hydrograph

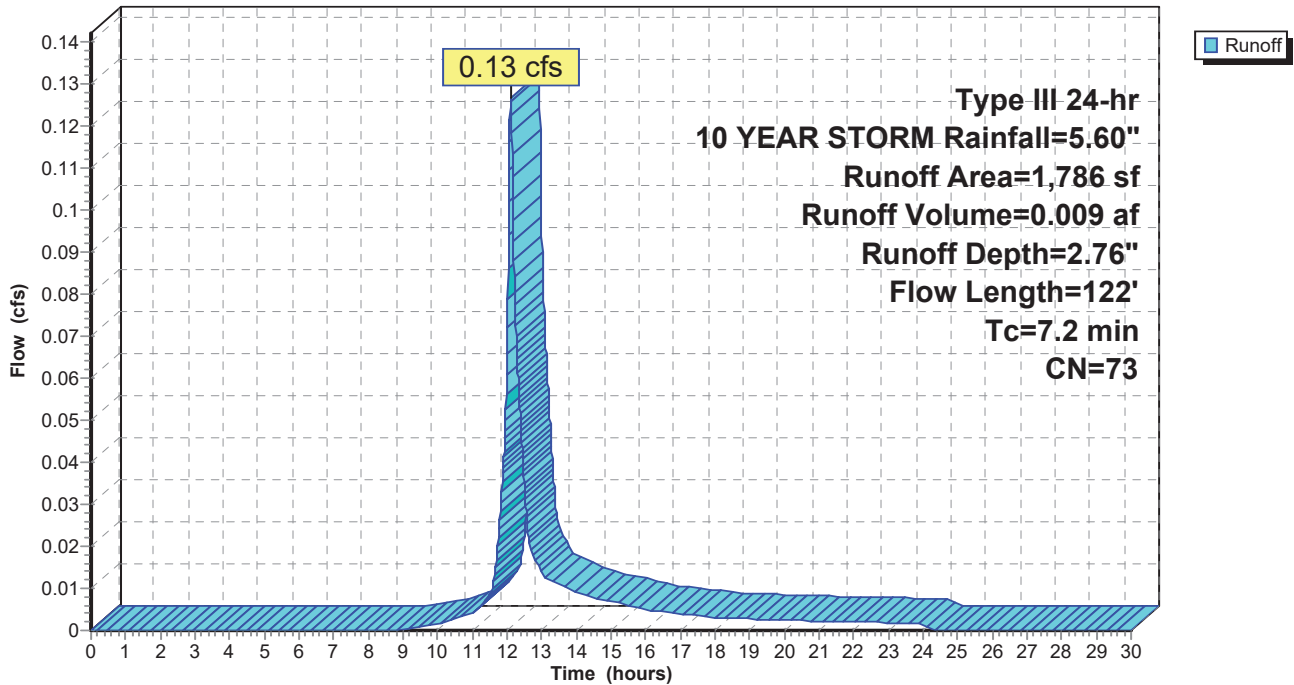



**Summary for Pond 1-P: DMH P1**

[80] Warning: Exceeded Pond 2-P by 0.02' @ 24.32 hrs (0.00 cfs 0.000 af)

Inflow Area = 0.681 ac, 41.31% Impervious, Inflow Depth = 3.83" for 10 YEAR STORM event  
 Inflow = 0.84 cfs @ 12.09 hrs, Volume= 0.217 af  
 Outflow = 0.84 cfs @ 12.09 hrs, Volume= 0.217 af, Atten= 0%, Lag= 0.0 min  
 Primary = 0.84 cfs @ 12.09 hrs, Volume= 0.217 af

Routing by Dyn-Stor-Ind method, Time Span= 0.00-30.00 hrs, dt= 0.01 hrs  
 Peak Elev= 53.27' @ 12.09 hrs  
 Flood Elev= 58.70'

Device	Routing	Invert	Outlet Devices
#1	Primary	52.72'	<b>12.0" Round Culvert</b> L= 33.0' CPP, square edge headwall, Ke= 0.500 Inlet / Outlet Invert= 52.72' / 52.55' S= 0.0052 '/ Cc= 0.900 n= 0.012, Flow Area= 0.79 sf

**Primary OutFlow** Max=0.84 cfs @ 12.09 hrs HW=53.27' TW=0.00' (Dynamic Tailwater)  
 ←1=Culvert (Barrel Controls 0.84 cfs @ 2.78 fps)

**Pond 1-P: DMH P1**

Hydrograph

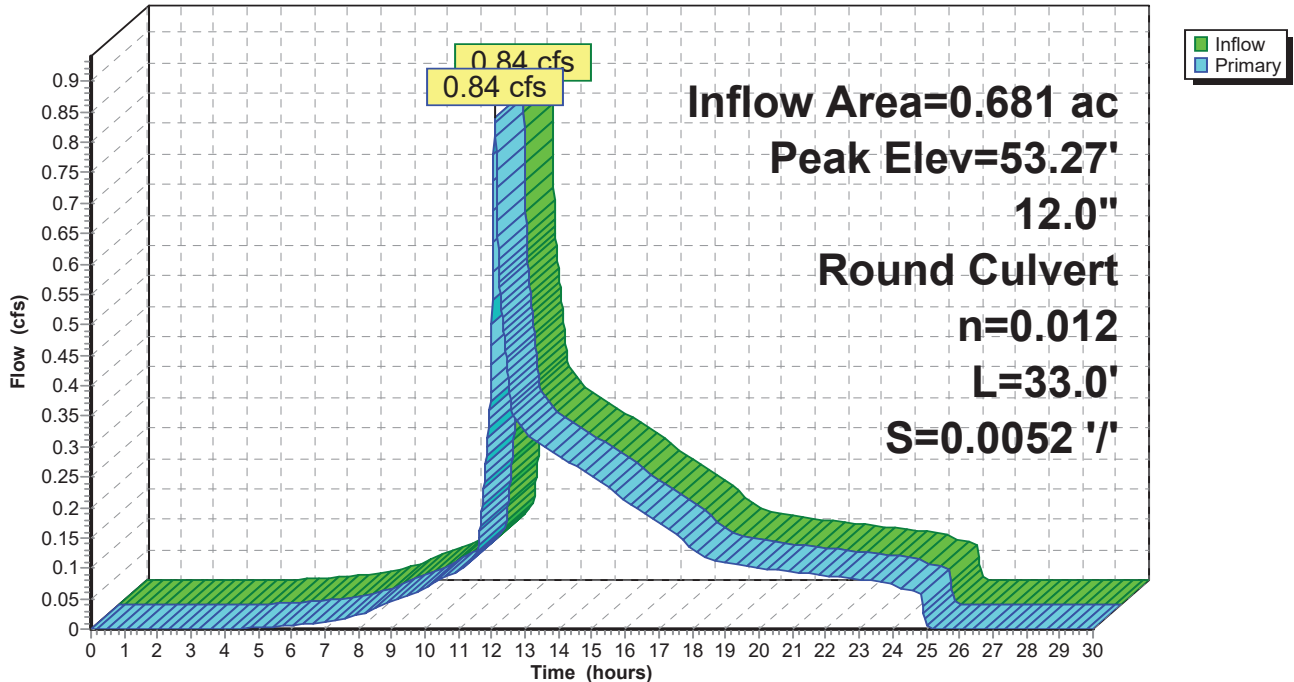

**Summary for Pond 2-P: CB P2**

Inflow Area = 0.151 ac, 42.96% Impervious, Inflow Depth = 3.89" for 10 YEAR STORM event  
 Inflow = 0.68 cfs @ 12.09 hrs, Volume= 0.049 af  
 Outflow = 0.68 cfs @ 12.09 hrs, Volume= 0.049 af, Atten= 0%, Lag= 0.0 min  
 Primary = 0.68 cfs @ 12.09 hrs, Volume= 0.049 af

Routing by Dyn-Stor-Ind method, Time Span= 0.00-30.00 hrs, dt= 0.01 hrs  
 Peak Elev= 53.39' @ 12.09 hrs  
 Flood Elev= 57.25'

Device	Routing	Invert	Outlet Devices
#1	Primary	52.84'	<b>12.0" Round Culvert</b> L= 4.0' CPP, square edge headwall, Ke= 0.500 Inlet / Outlet Invert= 52.84' / 52.82' S= 0.0050 '/ Cc= 0.900 n= 0.012, Flow Area= 0.79 sf

**Primary OutFlow** Max=0.66 cfs @ 12.09 hrs HW=53.39' TW=53.26' (Dynamic Tailwater)  
 ←1=Culvert (Outlet Controls 0.66 cfs @ 2.20 fps)

**Pond 2-P: CB P2**

Hydrograph

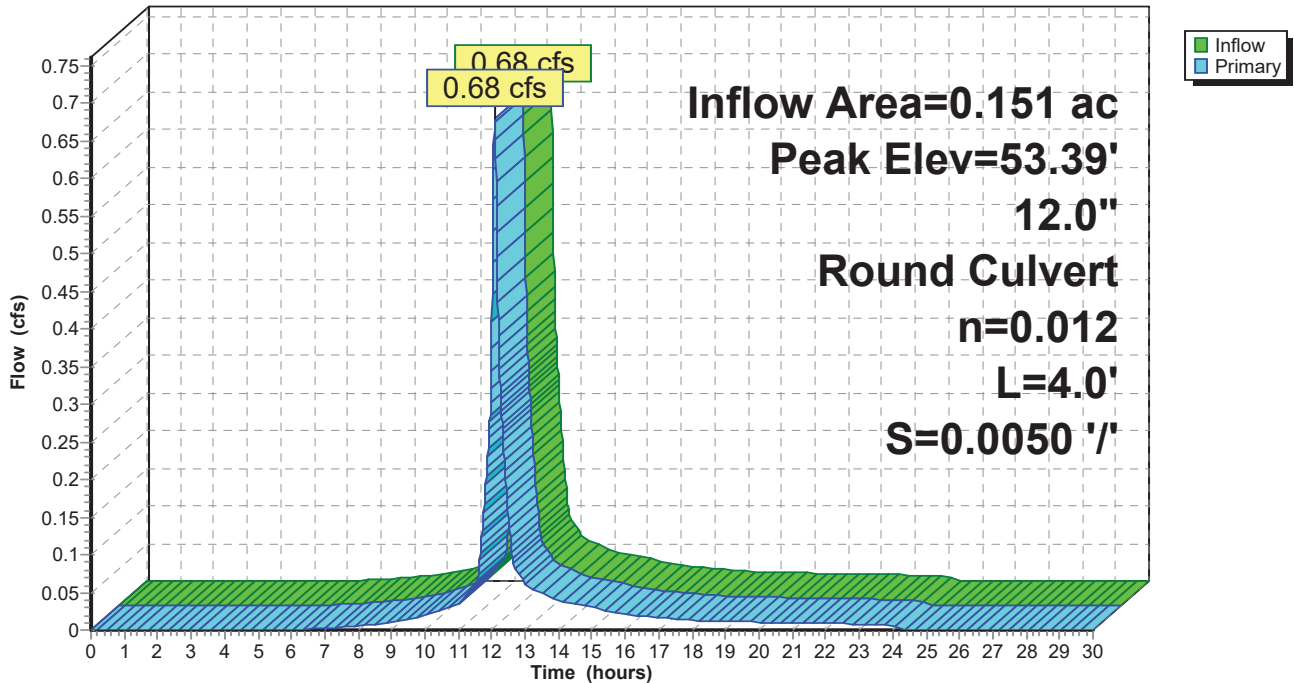

**Summary for Pond 3-P: CB-P3**

Inflow Area = 0.045 ac, 48.90% Impervious, Inflow Depth = 4.03" for 10 YEAR STORM event  
 Inflow = 0.21 cfs @ 12.09 hrs, Volume= 0.015 af  
 Outflow = 0.21 cfs @ 12.09 hrs, Volume= 0.015 af, Atten= 0%, Lag= 0.0 min  
 Primary = 0.21 cfs @ 12.09 hrs, Volume= 0.015 af

Routing by Dyn-Stor-Ind method, Time Span= 0.00-30.00 hrs, dt= 0.01 hrs  
 Peak Elev= 53.44' @ 12.10 hrs  
 Flood Elev= 57.35'

Device	Routing	Invert	Outlet Devices
#1	Primary	53.06'	<b>12.0" Round Culvert</b> L= 23.0' CPP, square edge headwall, Ke= 0.500 Inlet / Outlet Invert= 53.06' / 52.94' S= 0.0052 '/ Cc= 0.900 n= 0.012, Flow Area= 0.79 sf

**Primary OutFlow** Max=0.19 cfs @ 12.09 hrs HW=53.43' TW=53.39' (Dynamic Tailwater)  
 ←**1=Culvert** (Outlet Controls 0.19 cfs @ 1.08 fps)

**Pond 3-P: CB-P3**

Hydrograph

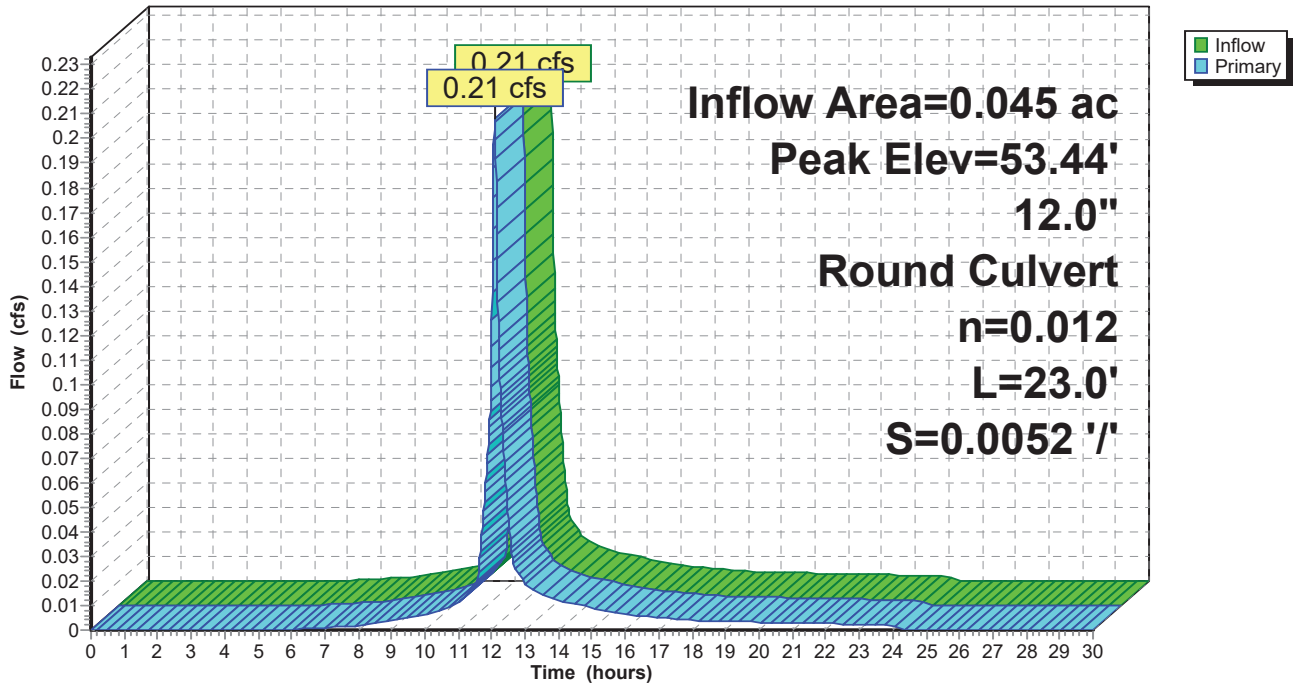

**Summary for Pond 4-P: Cul-de-sac Raingarden**

Inflow Area = 0.254 ac, 65.89% Impervious, Inflow Depth = 4.46" for 10 YEAR STORM event  
 Inflow = 1.27 cfs @ 12.08 hrs, Volume= 0.094 af  
 Outflow = 1.25 cfs @ 12.10 hrs, Volume= 0.094 af, Atten= 2%, Lag= 1.0 min  
 Primary = 1.25 cfs @ 12.10 hrs, Volume= 0.094 af

Routing by Dyn-Stor-Ind method, Time Span= 0.00-30.00 hrs, dt= 0.01 hrs  
 Peak Elev= 61.65' @ 12.10 hrs Surf.Area= 699 sf Storage= 471 cf  
 Flood Elev= 62.00' Surf.Area= 804 sf Storage= 734 cf

Plug-Flow detention time= 51.2 min calculated for 0.094 af (100% of inflow)  
 Center-of-Mass det. time= 51.2 min ( 838.2 - 786.9 )

Volume	Invert	Avail.Storage	Storage Description		
#1	60.85'	1,016 cf	<b>Custom Stage Data (Conic)</b> Listed below (Recalc)		
Elevation (feet)	Surf.Area (sq-ft)	Inc.Store (cubic-feet)	Cum.Store (cubic-feet)	Wet.Area (sq-ft)	
60.85	486	0	0	486	
61.00	522	76	76	524	
62.00	804	658	734	820	
62.30	1,084	282	1,016	1,102	

Device	Routing	Invert	Outlet Devices
#1	Primary	58.35'	<b>12.0" Round Culvert</b> L= 140.0' CPP, square edge headwall, Ke= 0.500 Inlet / Outlet Invert= 58.35' / 58.00' S= 0.0025 ' / ' Cc= 0.900 n= 0.012, Flow Area= 0.79 sf
#2	Device 1	61.50'	<b>24.0" Horiz. Orifice/Grate</b> C= 0.600 Limited to weir flow at low heads
#3	Device 1	58.35'	<b>4.0" Vert. Orifice/Grate</b> C= 0.600
#4	Device 3	60.85'	<b>2.500 in/hr Exfiltration througuh Media over Wetted area</b> Phase-In= 0.01'

**Primary OutFlow** Max=1.25 cfs @ 12.10 hrs HW=61.65' TW=58.97' (Dynamic Tailwater)

- 1=Culvert (Passes 1.25 cfs of 4.48 cfs potential flow)
- 2=Orifice/Grate (Weir Controls 1.20 cfs @ 1.27 fps)
- 3=Orifice/Grate (Passes 0.04 cfs of 0.69 cfs potential flow)
- 4=Exfiltration througuh Media (Exfiltration Controls 0.04 cfs)

### Pond 4-P: Cul-de-sac Raingarden

Hydrograph

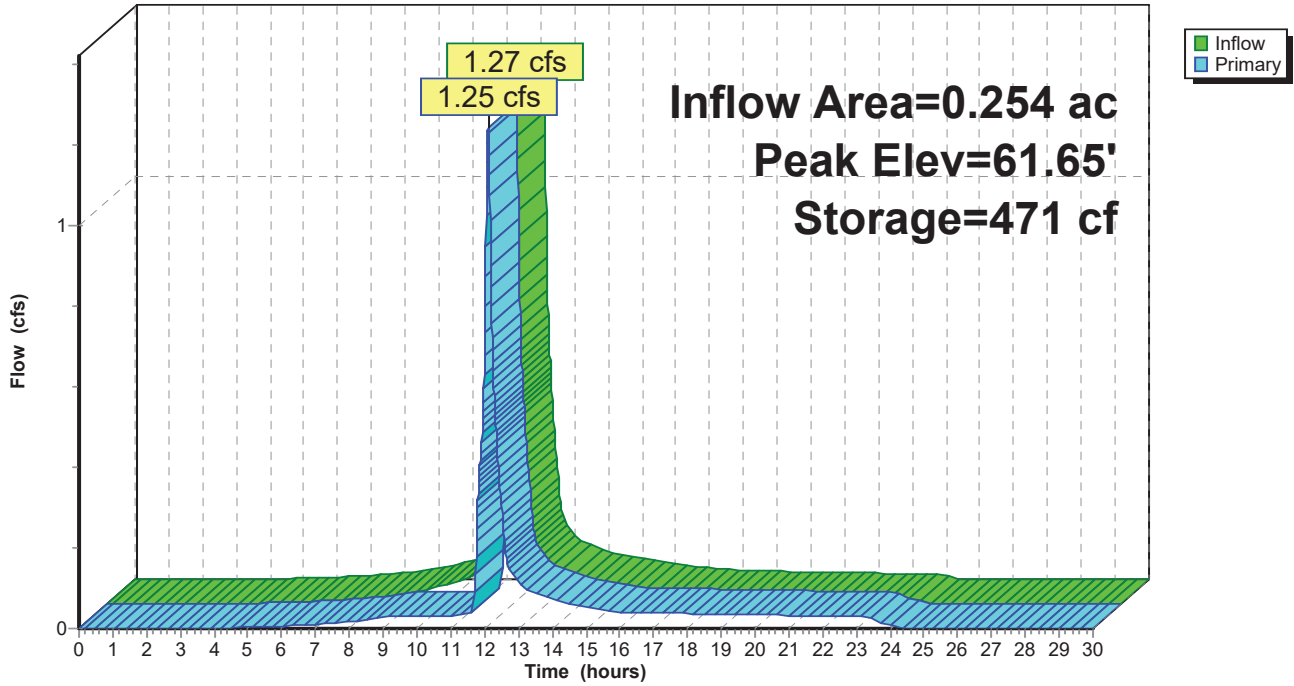

**Summary for Pond 5-P: Front Raingarden**

Inflow Area = 0.529 ac, 40.84% Impervious, Inflow Depth = 3.82" for 10 YEAR STORM event  
 Inflow = 2.28 cfs @ 12.10 hrs, Volume= 0.168 af  
 Outflow = 0.26 cfs @ 12.81 hrs, Volume= 0.168 af, Atten= 88%, Lag= 42.6 min  
 Primary = 0.26 cfs @ 12.81 hrs, Volume= 0.168 af

Routing by Dyn-Stor-Ind method, Time Span= 0.00-30.00 hrs, dt= 0.01 hrs  
 Peak Elev= 59.54' @ 12.81 hrs Surf.Area= 2,909 sf Storage= 2,847 cf  
 Flood Elev= 60.00' Surf.Area= 3,734 sf Storage= 4,357 cf

Plug-Flow detention time= 130.4 min calculated for 0.168 af (100% of inflow)  
 Center-of-Mass det. time= 130.3 min ( 961.4 - 831.1 )

Volume	Invert	Avail.Storage	Storage Description		
#1	58.00'	5,655 cf	<b>Custom Stage Data (Conic)</b> Listed below (Recalc)		
Elevation (feet)	Surf.Area (sq-ft)	Inc.Store (cubic-feet)	Cum.Store (cubic-feet)	Wet.Area (sq-ft)	
58.00	1,007	0	0	1,007	
59.00	2,059	1,502	1,502	2,068	
60.00	3,734	2,855	4,357	3,753	
60.33	4,133	1,297	5,655	4,159	

Device	Routing	Invert	Outlet Devices
#1	Primary	53.00'	<b>12.0" Round Culvert</b> L= 11.0' CPP, square edge headwall, Ke= 0.500 Inlet / Outlet Invert= 53.00' / 52.82' S= 0.0164 1' Cc= 0.900 n= 0.012, Flow Area= 0.79 sf
#2	Device 1	59.83'	<b>24.0" Horiz. Orifice/Grate</b> C= 0.600 Limited to weir flow at low heads
#3	Device 1	55.50'	<b>4.0" Vert. Orifice/Grate</b> C= 0.600
#4	Device 3	58.00'	<b>2.500 in/hr Exfiltration through Media over Wetted area</b> Phase-In= 0.01'
#5	Device 1	58.65'	<b>2.0" Vert. Orifice/Grate</b> C= 0.600

**Primary OutFlow** Max=0.26 cfs @ 12.81 hrs HW=59.54' TW=53.05' (Dynamic Tailwater)

- 1=Culvert (Passes 0.26 cfs of 9.30 cfs potential flow)
- 2=Orifice/Grate ( Controls 0.00 cfs)
- 3=Orifice/Grate (Passes 0.17 cfs of 0.83 cfs potential flow)
- 4=Exfiltration through Media (Exfiltration Controls 0.17 cfs)
- 5=Orifice/Grate (Orifice Controls 0.09 cfs @ 4.34 fps)

### Pond 5-P: Front Raingarden

Hydrograph

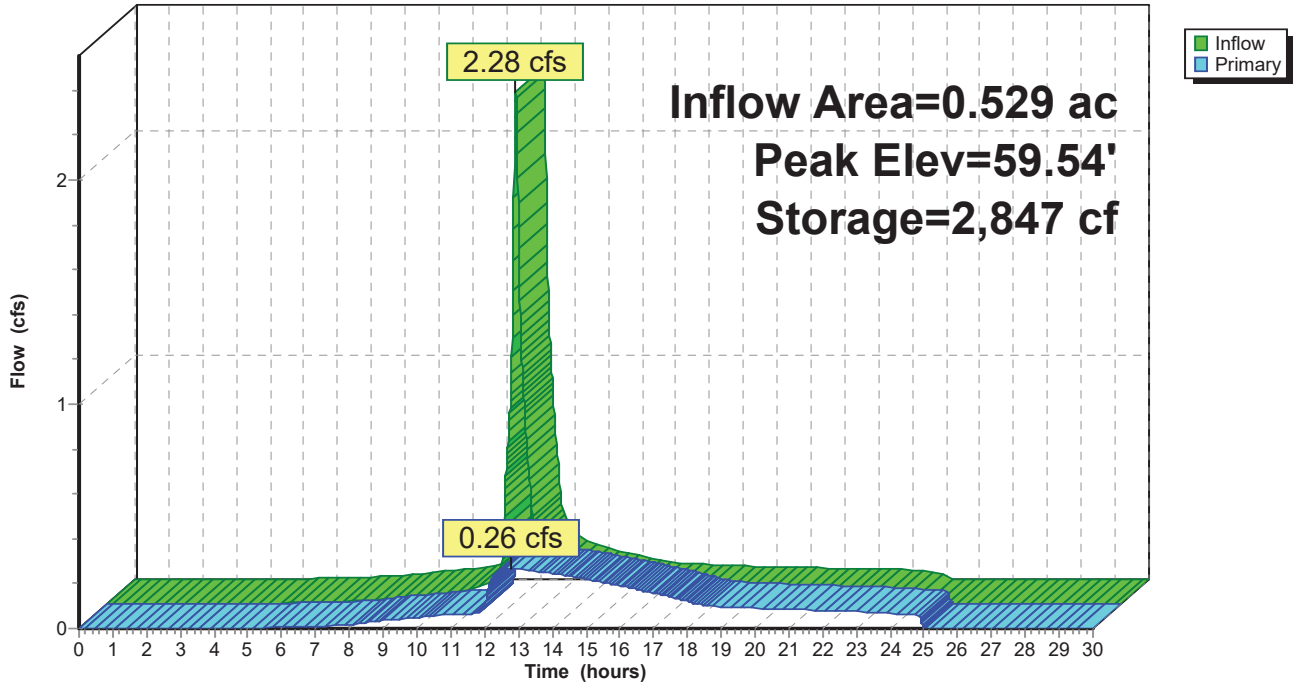

**Summary for Pond 6-P: Southeast Raingarden**

Inflow Area = 0.487 ac, 23.11% Impervious, Inflow Depth = 3.32" for 10 YEAR STORM event  
 Inflow = 1.76 cfs @ 12.12 hrs, Volume= 0.135 af  
 Outflow = 0.70 cfs @ 12.40 hrs, Volume= 0.129 af, Atten= 60%, Lag= 16.9 min  
 Primary = 0.70 cfs @ 12.40 hrs, Volume= 0.129 af

Routing by Dyn-Stor-Ind method, Time Span= 0.00-30.00 hrs, dt= 0.01 hrs  
 Starting Elev= 58.67' Surf.Area= 809 sf Storage= 61 cf  
 Peak Elev= 60.14' @ 12.40 hrs Surf.Area= 1,739 sf Storage= 1,826 cf (1,765 cf above start)  
 Flood Elev= 61.00' Surf.Area= 2,787 sf Storage= 3,755 cf (3,694 cf above start)

Plug-Flow detention time= 95.0 min calculated for 0.128 af (95% of inflow)  
 Center-of-Mass det. time= 64.1 min ( 885.6 - 821.5 )

Volume	Invert	Avail.Storage	Storage Description		
#1	57.17'	3,755 cf	<b>Custom Stage Data (Conic)</b> Listed below (Recalc)		
Elevation (feet)	Surf.Area (sq-ft)	Voids (%)	Inc.Store (cubic-feet)	Cum.Store (cubic-feet)	Wet.Area (sq-ft)
57.17	809	0.0	0	0	809
58.67	809	5.0	61	61	960
59.00	929	100.0	287	347	1,085
60.00	1,592	100.0	1,246	1,593	1,760
61.00	2,787	100.0	2,162	3,755	2,966

Device	Routing	Invert	Outlet Devices
#1	Primary	56.18'	<b>12.0" Round Culvert</b> L= 26.0' CPP, square edge headwall, Ke= 0.500 Inlet / Outlet Invert= 56.18' / 56.05' S= 0.0050 ' /' Cc= 0.900 n= 0.012, Flow Area= 0.79 sf
#2	Device 1	60.50'	<b>24.0" Horiz. Orifice/Grate</b> C= 0.600 Limited to weir flow at low heads
#3	Device 4	58.67'	<b>2.500 in/hr Exfiltration through Media over Wetted area above 58.67'</b> Excluded Wetted area = 960 sf Phase-In= 0.01'
#4	Device 1	56.18'	<b>4.0" Vert. Orifice/Grate</b> C= 0.600
#5	Device 1	59.10'	<b>5.2" Vert. Orifice/Grate</b> C= 0.600

**Primary OutFlow** Max=0.70 cfs @ 12.40 hrs HW=60.14' TW=0.00' (Dynamic Tailwater)

- 1=Culvert (Passes 0.70 cfs of 7.03 cfs potential flow)
- 2=Orifice/Grate ( Controls 0.00 cfs)
- 4=Orifice/Grate (Passes 0.05 cfs of 0.82 cfs potential flow)
- 3=Exfiltration through Media (Exfiltration Controls 0.05 cfs)
- 5=Orifice/Grate (Orifice Controls 0.64 cfs @ 4.37 fps)



### Pond 6-P: Southeast Raingarden

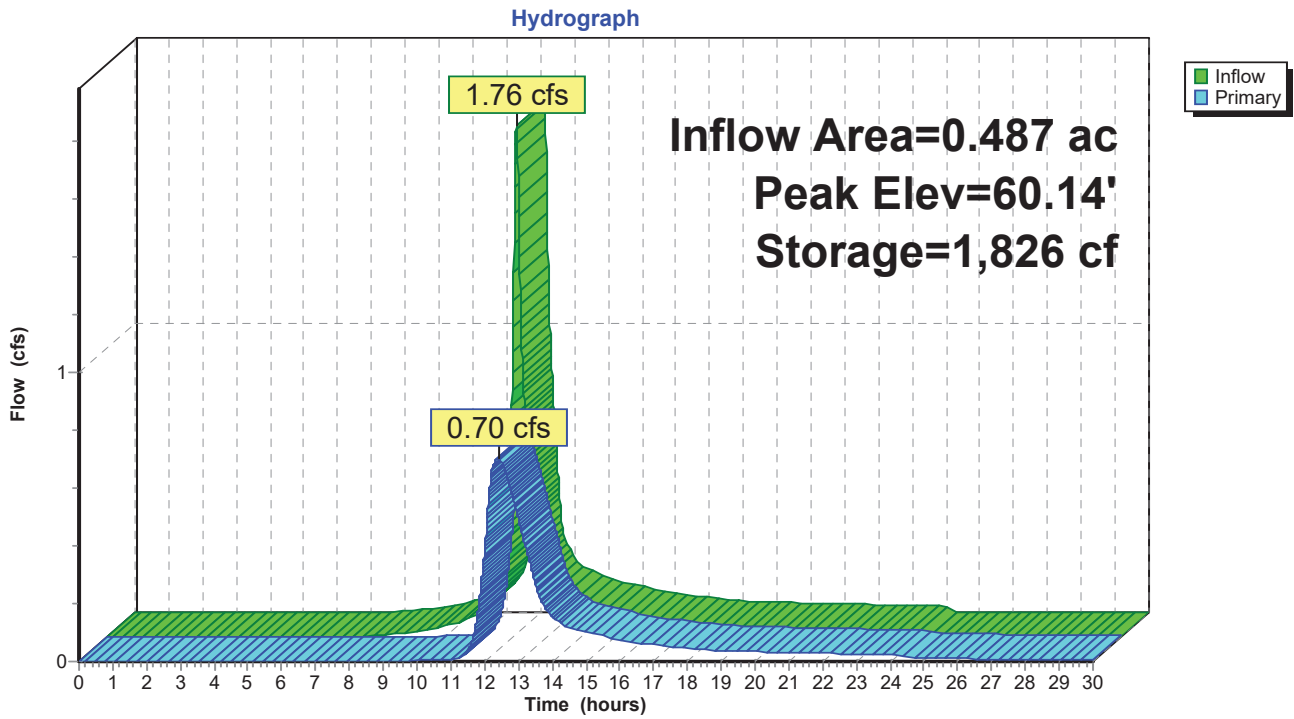

### Summary for Link POA 1: City Drainage System

Inflow Area = 0.775 ac, 45.87% Impervious, Inflow Depth = 3.95" for 10 YEAR STORM event  
Inflow = 1.33 cfs @ 12.09 hrs, Volume= 0.255 af  
Primary = 1.33 cfs @ 12.09 hrs, Volume= 0.255 af, Atten= 0%, Lag= 0.0 min

Primary outflow = Inflow, Time Span= 0.00-30.00 hrs, dt= 0.01 hrs

### Link POA 1: City Drainage System

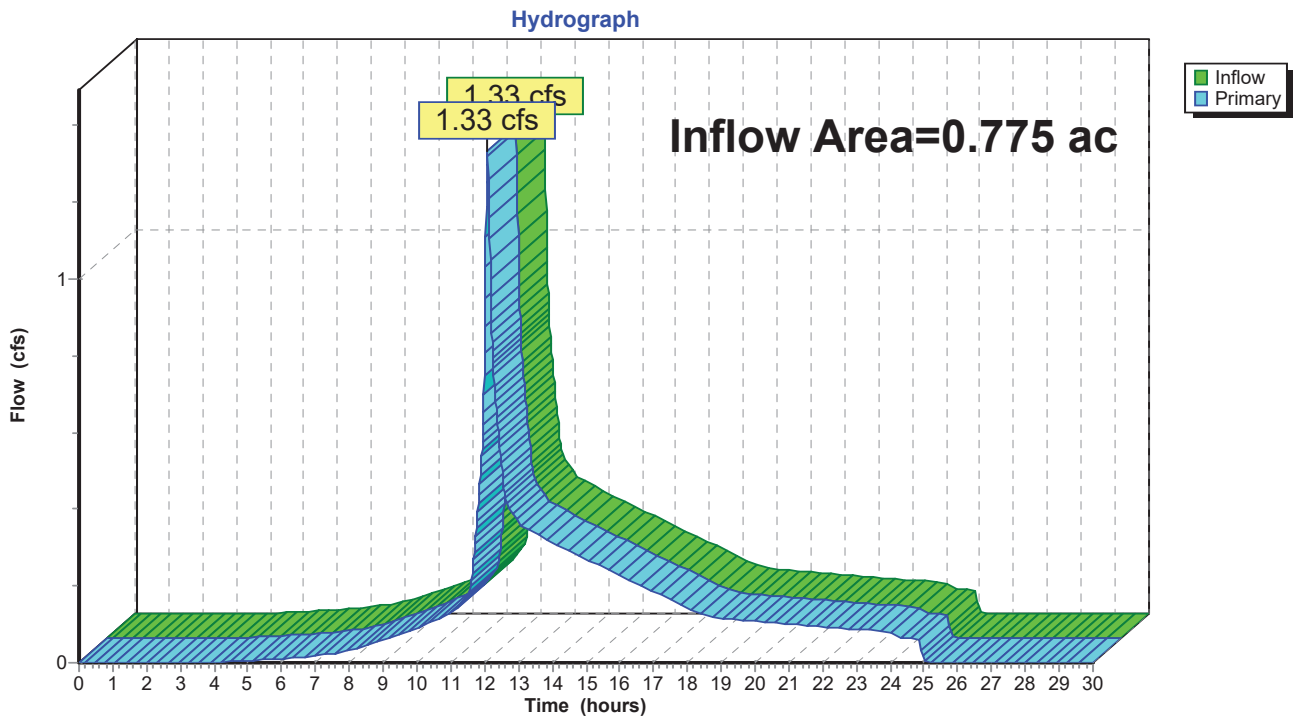

### Summary for Link POA 2: (new Link)

Inflow Area = 0.631 ac, 17.96% Impervious, Inflow Depth > 3.07" for 10 YEAR STORM event  
Inflow = 0.98 cfs @ 12.12 hrs, Volume= 0.161 af  
Primary = 0.98 cfs @ 12.12 hrs, Volume= 0.161 af, Atten= 0%, Lag= 0.0 min

Primary outflow = Inflow, Time Span= 0.00-30.00 hrs, dt= 0.01 hrs

### Link POA 2: (new Link)

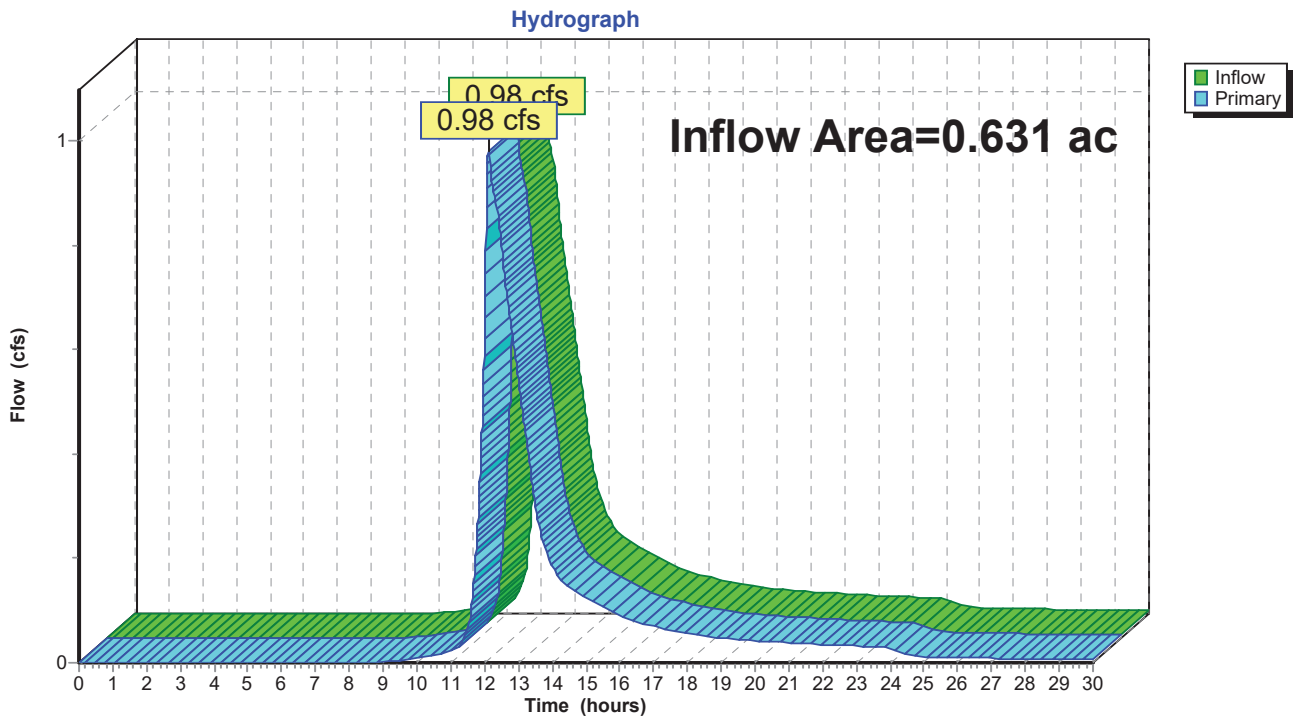

### Summary for Link POA 3: Wetland

Inflow Area = 0.079 ac, 16.09% Impervious, Inflow Depth = 3.32" for 10 YEAR STORM event  
Inflow = 0.31 cfs @ 12.09 hrs, Volume= 0.022 af  
Primary = 0.31 cfs @ 12.09 hrs, Volume= 0.022 af, Atten= 0%, Lag= 0.0 min

Primary outflow = Inflow, Time Span= 0.00-30.00 hrs, dt= 0.01 hrs

### Link POA 3: Wetland

Hydrograph

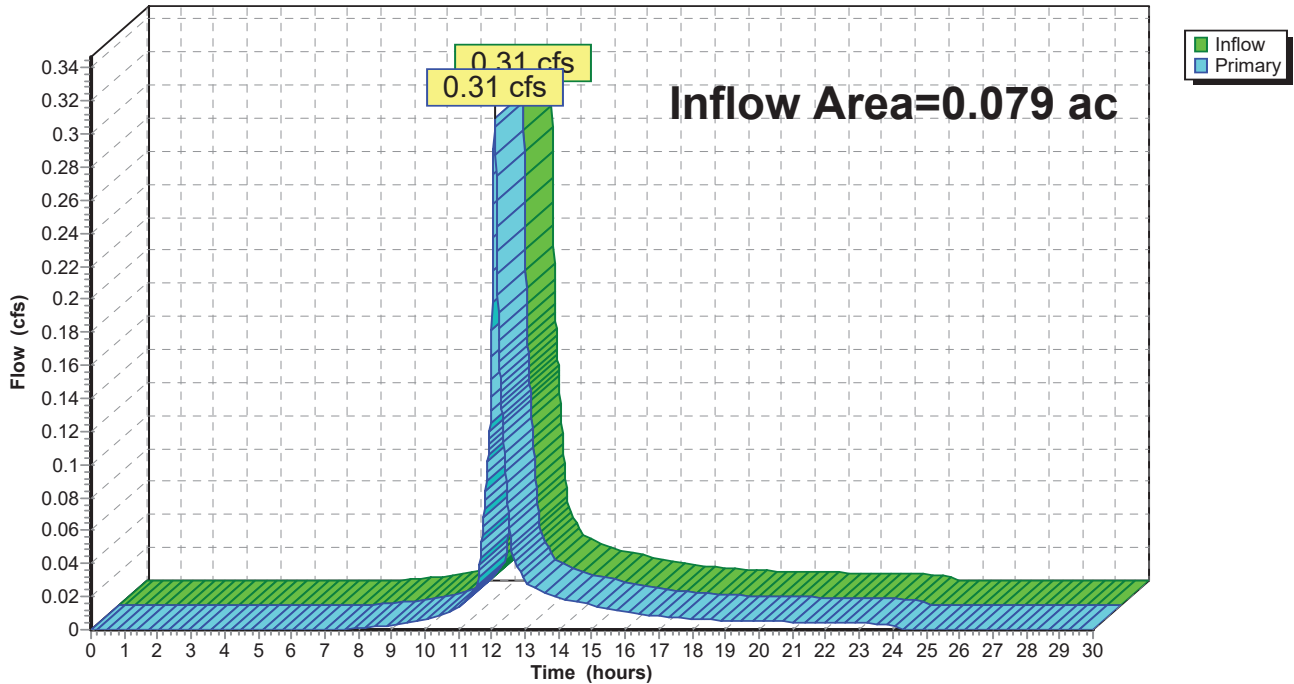

### Summary for Link POA 4: (new Link)

Inflow Area = 0.041 ac, 3.02% Impervious, Inflow Depth = 2.76" for 10 YEAR STORM event  
Inflow = 0.13 cfs @ 12.11 hrs, Volume= 0.009 af  
Primary = 0.13 cfs @ 12.11 hrs, Volume= 0.009 af, Atten= 0%, Lag= 0.0 min

Primary outflow = Inflow, Time Span= 0.00-30.00 hrs, dt= 0.01 hrs

### Link POA 4: (new Link)

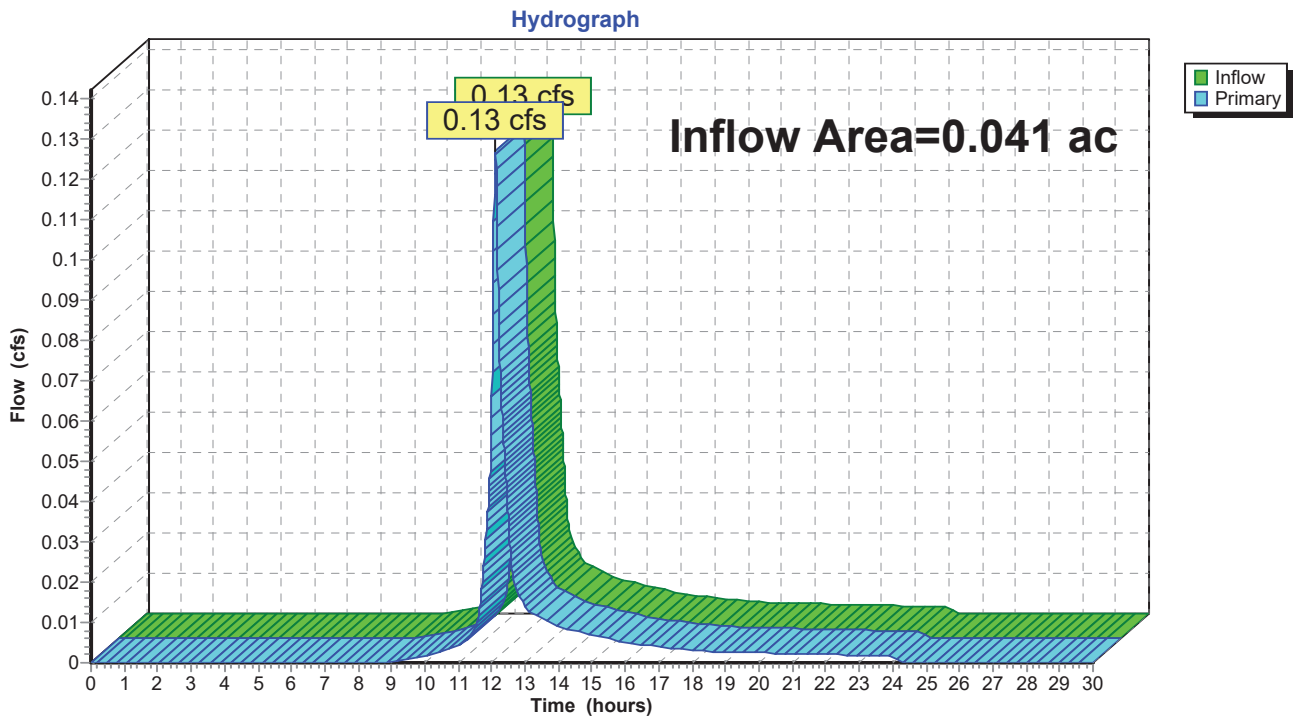

Time span=0.00-30.00 hrs, dt=0.01 hrs, 3001 points  
 Runoff by SCS TR-20 method, UH=SCS, Weighted-CN  
 Reach routing by Dyn-Stor-Ind method - Pond routing by Dyn-Stor-Ind method

<b>Subcatchment 1-A: 1-A</b>	Runoff Area=4,099 sf 78.87% Impervious Runoff Depth=2.93" Tc=6.0 min CN=93 Runoff=0.31 cfs 0.023 af
<b>Subcatchment 1-B: 1-B</b>	Runoff Area=11,993 sf 17.73% Impervious Runoff Depth=1.65" Flow Length=90' Tc=6.0 min CN=78 Runoff=0.53 cfs 0.038 af
<b>Subcatchment 1-C: 1-C</b>	Runoff Area=11,062 sf 65.89% Impervious Runoff Depth=2.64" Tc=6.0 min CN=90 Runoff=0.77 cfs 0.056 af
<b>Subcatchment 1-D: 1-D</b>	Runoff Area=4,631 sf 40.44% Impervious Runoff Depth=2.11" Flow Length=135' Tc=6.0 min CN=84 Runoff=0.26 cfs 0.019 af
<b>Subcatchment 1-E: 1-E</b>	Runoff Area=1,957 sf 48.90% Impervious Runoff Depth=2.28" Tc=6.0 min CN=86 Runoff=0.12 cfs 0.009 af
<b>Subcatchment 2-A: 2-A</b>	Runoff Area=21,222 sf 23.11% Impervious Runoff Depth=1.72" Flow Length=188' Tc=8.1 min CN=79 Runoff=0.91 cfs 0.070 af
<b>Subcatchment 2-B: 2-B</b>	Runoff Area=6,257 sf 0.48% Impervious Runoff Depth=1.25" Flow Length=145' Tc=6.0 min CN=72 Runoff=0.20 cfs 0.015 af
<b>Subcatchment 3: 3</b>	Runoff Area=3,462 sf 16.09% Impervious Runoff Depth=1.72" Tc=6.0 min CN=79 Runoff=0.16 cfs 0.011 af
<b>Subcatchment 4: 4</b>	Runoff Area=1,786 sf 3.02% Impervious Runoff Depth=1.32" Flow Length=122' Tc=7.2 min CN=73 Runoff=0.06 cfs 0.004 af
<b>Pond 1-P: DMH P1</b>	Peak Elev=53.11' Inflow=0.46 cfs 0.121 af 12.0" Round Culvert n=0.012 L=33.0' S=0.0052 ' Outflow=0.46 cfs 0.121 af
<b>Pond 2-P: CB P2</b>	Peak Elev=53.22' Inflow=0.38 cfs 0.027 af 12.0" Round Culvert n=0.012 L=4.0' S=0.0050 ' Outflow=0.38 cfs 0.027 af
<b>Pond 3-P: CB-P3</b>	Peak Elev=53.30' Inflow=0.12 cfs 0.009 af 12.0" Round Culvert n=0.012 L=23.0' S=0.0052 ' Outflow=0.12 cfs 0.009 af
<b>Pond 4-P: Cul-de-sac Raingarden</b>	Peak Elev=61.61' Storage=440 cf Inflow=0.77 cfs 0.056 af Outflow=0.74 cfs 0.056 af
<b>Pond 5-P: Front Raingarden</b>	Peak Elev=58.89' Storage=1,289 cf Inflow=1.26 cfs 0.094 af Outflow=0.15 cfs 0.094 af
<b>Pond 6-P: Southeast Raingarden</b>	Peak Elev=59.59' Storage=1,004 cf Inflow=0.91 cfs 0.070 af Outflow=0.40 cfs 0.065 af
<b>Link POA 1: City Drainage System</b>	Inflow=0.77 cfs 0.144 af Primary=0.77 cfs 0.144 af

**5591-POST-072624**

*Type III 24-hr 2 YEAR STORM Rainfall=3.70"*

Prepared by Altus Engineering, Inc.

Printed 10/23/2024

HydroCAD® 10.00-26 s/n 01222 © 2020 HydroCAD Software Solutions LLC

Page 47

**Link POA 2: (new Link)**

Inflow=0.49 cfs 0.080 af  
Primary=0.49 cfs 0.080 af

**Link POA 3: Wetland**

Inflow=0.16 cfs 0.011 af  
Primary=0.16 cfs 0.011 af

**Link POA 4: (new Link)**

Inflow=0.06 cfs 0.004 af  
Primary=0.06 cfs 0.004 af

**Total Runoff Area = 1.526 ac   Runoff Volume = 0.245 af   Average Runoff Depth = 1.92"**  
**68.37% Pervious = 1.043 ac   31.63% Impervious = 0.483 ac**

Time span=0.00-30.00 hrs, dt=0.01 hrs, 3001 points  
 Runoff by SCS TR-20 method, UH=SCS, Weighted-CN  
 Reach routing by Dyn-Stor-Ind method - Pond routing by Dyn-Stor-Ind method

<b>Subcatchment 1-A: 1-A</b>	Runoff Area=4,099 sf 78.87% Impervious Runoff Depth=6.29" Tc=6.0 min CN=93 Runoff=0.64 cfs 0.049 af
<b>Subcatchment 1-B: 1-B</b>	Runoff Area=11,993 sf 17.73% Impervious Runoff Depth=4.58" Flow Length=90' Tc=6.0 min CN=78 Runoff=1.47 cfs 0.105 af
<b>Subcatchment 1-C: 1-C</b>	Runoff Area=11,062 sf 65.89% Impervious Runoff Depth=5.94" Tc=6.0 min CN=90 Runoff=1.67 cfs 0.126 af
<b>Subcatchment 1-D: 1-D</b>	Runoff Area=4,631 sf 40.44% Impervious Runoff Depth=5.25" Flow Length=135' Tc=6.0 min CN=84 Runoff=0.64 cfs 0.047 af
<b>Subcatchment 1-E: 1-E</b>	Runoff Area=1,957 sf 48.90% Impervious Runoff Depth=5.48" Tc=6.0 min CN=86 Runoff=0.28 cfs 0.021 af
<b>Subcatchment 2-A: 2-A</b>	Runoff Area=21,222 sf 23.11% Impervious Runoff Depth=4.69" Flow Length=188' Tc=8.1 min CN=79 Runoff=2.48 cfs 0.191 af
<b>Subcatchment 2-B: 2-B</b>	Runoff Area=6,257 sf 0.48% Impervious Runoff Depth=3.93" Flow Length=145' Tc=6.0 min CN=72 Runoff=0.66 cfs 0.047 af
<b>Subcatchment 3: 3</b>	Runoff Area=3,462 sf 16.09% Impervious Runoff Depth=4.69" Tc=6.0 min CN=79 Runoff=0.43 cfs 0.031 af
<b>Subcatchment 4: 4</b>	Runoff Area=1,786 sf 3.02% Impervious Runoff Depth=4.04" Flow Length=122' Tc=7.2 min CN=73 Runoff=0.19 cfs 0.014 af
<b>Pond 1-P: DMH P1</b>	Peak Elev=53.37' Inflow=1.15 cfs 0.298 af 12.0" Round Culvert n=0.012 L=33.0' S=0.0052 ' Outflow=1.15 cfs 0.298 af
<b>Pond 2-P: CB P2</b>	Peak Elev=53.51' Inflow=0.92 cfs 0.067 af 12.0" Round Culvert n=0.012 L=4.0' S=0.0050 ' Outflow=0.92 cfs 0.067 af
<b>Pond 3-P: CB-P3</b>	Peak Elev=53.55' Inflow=0.28 cfs 0.021 af 12.0" Round Culvert n=0.012 L=23.0' S=0.0052 ' Outflow=0.28 cfs 0.021 af
<b>Pond 4-P: Cul-de-sac Raingarden</b>	Peak Elev=61.68' Storage=493 cf Inflow=1.67 cfs 0.126 af Outflow=1.64 cfs 0.126 af
<b>Pond 5-P: Front Raingarden</b>	Peak Elev=59.90' Storage=3,995 cf Inflow=3.10 cfs 0.231 af Outflow=0.70 cfs 0.231 af
<b>Pond 6-P: Southeast Raingarden</b>	Peak Elev=60.52' Storage=2,559 cf Inflow=2.48 cfs 0.191 af Outflow=0.90 cfs 0.185 af
<b>Link POA 1: City Drainage System</b>	Inflow=1.78 cfs 0.347 af Primary=1.78 cfs 0.347 af



**5591-POST-072624**

Type III 24-hr 25 YEAR STORM Rainfall=7.12"

Prepared by Altus Engineering, Inc.

Printed 10/23/2024

HydroCAD® 10.00-26 s/n 01222 © 2020 HydroCAD Software Solutions LLC

Page 49

**Link POA 2: (new Link)**

Inflow=1.32 cfs 0.232 af  
Primary=1.32 cfs 0.232 af

**Link POA 3: Wetland**

Inflow=0.43 cfs 0.031 af  
Primary=0.43 cfs 0.031 af

**Link POA 4: (new Link)**

Inflow=0.19 cfs 0.014 af  
Primary=0.19 cfs 0.014 af

**Total Runoff Area = 1.526 ac   Runoff Volume = 0.630 af   Average Runoff Depth = 4.95"**  
**68.37% Pervious = 1.043 ac   31.63% Impervious = 0.483 ac**

Time span=0.00-30.00 hrs, dt=0.01 hrs, 3001 points  
 Runoff by SCS TR-20 method, UH=SCS, Weighted-CN  
 Reach routing by Dyn-Stor-Ind method - Pond routing by Dyn-Stor-Ind method

<b>Subcatchment 1-A: 1-A</b>	Runoff Area=4,099 sf 78.87% Impervious Runoff Depth=7.67" Tc=6.0 min CN=93 Runoff=0.77 cfs 0.060 af
<b>Subcatchment 1-B: 1-B</b>	Runoff Area=11,993 sf 17.73% Impervious Runoff Depth=5.86" Flow Length=90' Tc=6.0 min CN=78 Runoff=1.87 cfs 0.135 af
<b>Subcatchment 1-C: 1-C</b>	Runoff Area=11,062 sf 65.89% Impervious Runoff Depth=7.31" Tc=6.0 min CN=90 Runoff=2.03 cfs 0.155 af
<b>Subcatchment 1-D: 1-D</b>	Runoff Area=4,631 sf 40.44% Impervious Runoff Depth=6.59" Flow Length=135' Tc=6.0 min CN=84 Runoff=0.79 cfs 0.058 af
<b>Subcatchment 1-E: 1-E</b>	Runoff Area=1,957 sf 48.90% Impervious Runoff Depth=6.83" Tc=6.0 min CN=86 Runoff=0.34 cfs 0.026 af
<b>Subcatchment 2-A: 2-A</b>	Runoff Area=21,222 sf 23.11% Impervious Runoff Depth=5.98" Flow Length=188' Tc=8.1 min CN=79 Runoff=3.13 cfs 0.243 af
<b>Subcatchment 2-B: 2-B</b>	Runoff Area=6,257 sf 0.48% Impervious Runoff Depth=5.14" Flow Length=145' Tc=6.0 min CN=72 Runoff=0.87 cfs 0.062 af
<b>Subcatchment 3: 3</b>	Runoff Area=3,462 sf 16.09% Impervious Runoff Depth=5.98" Tc=6.0 min CN=79 Runoff=0.55 cfs 0.040 af
<b>Subcatchment 4: 4</b>	Runoff Area=1,786 sf 3.02% Impervious Runoff Depth=5.26" Flow Length=122' Tc=7.2 min CN=73 Runoff=0.24 cfs 0.018 af
<b>Pond 1-P: DMH P1</b>	Peak Elev=53.68' Inflow=2.11 cfs 0.373 af 12.0" Round Culvert n=0.012 L=33.0' S=0.0052 '/' Outflow=2.11 cfs 0.373 af
<b>Pond 2-P: CB P2</b>	Peak Elev=53.70' Inflow=1.14 cfs 0.084 af 12.0" Round Culvert n=0.012 L=4.0' S=0.0050 '/' Outflow=1.14 cfs 0.084 af
<b>Pond 3-P: CB-P3</b>	Peak Elev=53.71' Inflow=0.34 cfs 0.026 af 12.0" Round Culvert n=0.012 L=23.0' S=0.0052 '/' Outflow=0.34 cfs 0.026 af
<b>Pond 4-P: Cul-de-sac Raingarden</b>	Peak Elev=61.71' Storage=512 cf Inflow=2.03 cfs 0.155 af Outflow=2.00 cfs 0.155 af
<b>Pond 5-P: Front Raingarden</b>	Peak Elev=59.99' Storage=4,316 cf Inflow=3.85 cfs 0.289 af Outflow=1.64 cfs 0.289 af
<b>Pond 6-P: Southeast Raingarden</b>	Peak Elev=60.63' Storage=2,806 cf Inflow=3.13 cfs 0.243 af Outflow=1.83 cfs 0.237 af
<b>Link POA 1: City Drainage System</b>	Inflow=2.44 cfs 0.433 af Primary=2.44 cfs 0.433 af

**5591-POST-072624**

Type III 24-hr 50 YEAR STORM Rainfall=8.51"

Prepared by Altus Engineering, Inc.

Printed 10/23/2024

HydroCAD® 10.00-26 s/n 01222 © 2020 HydroCAD Software Solutions LLC

Page 51

**Link POA 2: (new Link)**

Inflow=2.26 cfs 0.299 af  
Primary=2.26 cfs 0.299 af

**Link POA 3: Wetland**

Inflow=0.55 cfs 0.040 af  
Primary=0.55 cfs 0.040 af

**Link POA 4: (new Link)**

Inflow=0.24 cfs 0.018 af  
Primary=0.24 cfs 0.018 af

**Total Runoff Area = 1.526 ac   Runoff Volume = 0.795 af   Average Runoff Depth = 6.26"**  
**68.37% Pervious = 1.043 ac   31.63% Impervious = 0.483 ac**

# Section 5

## Precipitation Table

# Extreme Precipitation Tables

## Northeast Regional Climate Center

Data represents point estimates calculated from partial duration series. All precipitation amounts are displayed in inches.

Metadata for Point	
Smoothing State	Yes
Location	
Latitude	43.059 degrees North
Longitude	70.753 degrees West
Elevation	10 feet
Date/Time	Tue Jul 23 2024 09:29:50 GMT-0400 (Eastern Daylight Time)

### Extreme Precipitation Estimates

	5min	10min	15min	30min	60min	120min		1hr	2hr	3hr	6hr	12hr	24hr	48hr		1day	2day	4day	7day	10day	
1yr	0.26	0.40	0.50	0.65	0.82	1.04	1yr	0.70	0.98	1.21	1.56	2.03	2.66	2.93	1yr	2.36	2.82	3.23	3.95	4.56	1yr
2yr	0.32	0.50	0.62	0.82	1.02	1.30	2yr	0.88	1.18	1.52	1.94	2.49	3.22	3.58	2yr	2.85	3.44	3.95	4.69	5.34	2yr
5yr	0.37	0.58	0.73	0.98	1.25	1.61	5yr	1.08	1.47	1.89	2.43	3.14	4.07	4.59	5yr	3.61	4.41	5.05	5.95	6.72	5yr
10yr	0.41	0.65	0.82	1.12	1.45	1.89	10yr	1.26	1.73	2.24	2.90	3.76	4.87	5.54	10yr	4.31	5.33	6.10	7.12	7.99	10yr
25yr	0.48	0.76	0.97	1.34	1.78	2.35	25yr	1.54	2.15	2.78	3.64	4.75	6.18	7.11	25yr	5.47	6.84	7.83	9.05	10.07	25yr
50yr	0.54	0.86	1.10	1.54	2.08	2.77	50yr	1.79	2.53	3.30	4.34	5.68	7.40	8.60	50yr	6.55	8.27	9.45	10.84	12.00	50yr
100yr	0.60	0.97	1.25	1.78	2.43	3.27	100yr	2.10	2.99	3.92	5.17	6.79	8.87	10.40	100yr	7.85	10.00	11.42	13.00	14.30	100yr
200yr	0.68	1.11	1.43	2.06	2.84	3.85	200yr	2.45	3.53	4.64	6.15	8.10	10.63	12.57	200yr	9.41	12.09	13.81	15.59	17.05	200yr
500yr	0.80	1.32	1.72	2.50	3.50	4.79	500yr	3.02	4.40	5.79	7.74	10.25	13.51	16.17	500yr	11.95	15.55	17.74	19.84	21.53	500yr

### Lower Confidence Limits

	5min	10min	15min	30min	60min	120min		1hr	2hr	3hr	6hr	12hr	24hr	48hr		1day	2day	4day	7day	10day	
1yr	0.23	0.36	0.44	0.59	0.72	0.88	1yr	0.63	0.86	0.93	1.33	1.69	2.25	2.50	1yr	1.99	2.40	2.88	3.19	3.91	1yr
2yr	0.31	0.49	0.60	0.81	1.00	1.19	2yr	0.86	1.16	1.37	1.82	2.33	3.07	3.46	2yr	2.72	3.33	3.83	4.56	5.10	2yr
5yr	0.35	0.54	0.67	0.92	1.17	1.40	5yr	1.01	1.37	1.61	2.12	2.73	3.79	4.20	5yr	3.36	4.04	4.73	5.55	6.25	5yr
10yr	0.39	0.59	0.74	1.03	1.33	1.60	10yr	1.15	1.57	1.80	2.38	3.05	4.38	4.87	10yr	3.87	4.68	5.46	6.43	7.21	10yr
25yr	0.44	0.67	0.83	1.19	1.56	1.90	25yr	1.35	1.86	2.10	2.75	3.53	4.75	5.90	25yr	4.21	5.67	6.67	7.81	8.70	25yr
50yr	0.48	0.73	0.91	1.31	1.77	2.17	50yr	1.53	2.12	2.35	3.06	3.92	5.37	6.81	50yr	4.76	6.55	7.75	9.07	10.04	50yr
100yr	0.54	0.81	1.02	1.47	2.01	2.47	100yr	1.74	2.41	2.63	3.40	4.33	6.05	7.86	100yr	5.35	7.56	9.01	10.54	11.60	100yr
200yr	0.59	0.89	1.13	1.63	2.28	2.81	200yr	1.97	2.75	2.94	3.76	4.77	6.79	9.07	200yr	6.01	8.72	10.46	12.27	13.41	200yr
500yr	0.69	1.02	1.31	1.91	2.71	3.36	500yr	2.34	3.29	3.41	4.29	5.42	7.92	10.96	500yr	7.01	10.54	12.75	15.03	16.25	500yr

### Upper Confidence Limits

	5min	10min	15min	30min	60min	120min		1hr	2hr	3hr	6hr	12hr	24hr	48hr		1day	2day	4day	7day	10day	
1yr	0.29	0.44	0.54	0.72	0.89	1.08	1yr	0.77	1.06	1.26	1.74	2.20	2.98	3.17	1yr	2.64	3.05	3.59	4.38	5.05	1yr
2yr	0.34	0.52	0.64	0.87	1.07	1.27	2yr	0.92	1.24	1.48	1.96	2.51	3.43	3.71	2yr	3.03	3.57	4.10	4.85	5.63	2yr
5yr	0.40	0.62	0.77	1.05	1.34	1.62	5yr	1.15	1.59	1.89	2.54	3.25	4.35	4.97	5yr	3.85	4.78	5.39	6.39	7.17	5yr
10yr	0.47	0.72	0.89	1.25	1.61	1.98	10yr	1.39	1.94	2.29	3.11	3.96	5.35	6.22	10yr	4.73	5.98	6.84	7.86	8.77	10yr
25yr	0.58	0.88	1.09	1.56	2.05	2.58	25yr	1.77	2.52	2.96	4.08	5.17	7.76	8.36	25yr	6.87	8.04	9.18	10.36	11.43	25yr
50yr	0.67	1.03	1.28	1.83	2.47	3.14	50yr	2.13	3.07	3.60	5.01	6.34	9.71	10.48	50yr	8.60	10.08	11.48	12.75	13.99	50yr
100yr	0.79	1.20	1.50	2.17	2.98	3.82	100yr	2.57	3.74	4.39	6.17	7.80	12.14	13.13	100yr	10.75	12.63	14.35	15.73	17.12	100yr
200yr	0.93	1.40	1.77	2.56	3.58	4.67	200yr	3.09	4.57	5.35	7.61	9.59	15.23	16.47	200yr	13.48	15.84	17.98	19.39	20.95	200yr
500yr	1.15	1.72	2.21	3.21	4.57	6.07	500yr	3.94	5.94	6.95	10.06	12.63	20.56	22.24	500yr	18.19	21.39	24.22	25.56	27.37	500yr



# Section 6

## NRCS Soils Report

# Custom Soil Resource Report for Rockingham County, New Hampshire



# Preface

---

Soil surveys contain information that affects land use planning in survey areas. They highlight soil limitations that affect various land uses and provide information about the properties of the soils in the survey areas. Soil surveys are designed for many different users, including farmers, ranchers, foresters, agronomists, urban planners, community officials, engineers, developers, builders, and home buyers. Also, conservationists, teachers, students, and specialists in recreation, waste disposal, and pollution control can use the surveys to help them understand, protect, or enhance the environment.

Various land use regulations of Federal, State, and local governments may impose special restrictions on land use or land treatment. Soil surveys identify soil properties that are used in making various land use or land treatment decisions. The information is intended to help the land users identify and reduce the effects of soil limitations on various land uses. The landowner or user is responsible for identifying and complying with existing laws and regulations.

Although soil survey information can be used for general farm, local, and wider area planning, onsite investigation is needed to supplement this information in some cases. Examples include soil quality assessments (<http://www.nrcs.usda.gov/wps/portal/nrcs/main/soils/health/>) and certain conservation and engineering applications. For more detailed information, contact your local USDA Service Center (<https://offices.sc.egov.usda.gov/locator/app?agency=nrcs>) or your NRCS State Soil Scientist ([http://www.nrcs.usda.gov/wps/portal/nrcs/detail/soils/contactus/?cid=nrcs142p2\\_053951](http://www.nrcs.usda.gov/wps/portal/nrcs/detail/soils/contactus/?cid=nrcs142p2_053951)).

Great differences in soil properties can occur within short distances. Some soils are seasonally wet or subject to flooding. Some are too unstable to be used as a foundation for buildings or roads. Clayey or wet soils are poorly suited to use as septic tank absorption fields. A high water table makes a soil poorly suited to basements or underground installations.

The National Cooperative Soil Survey is a joint effort of the United States Department of Agriculture and other Federal agencies, State agencies including the Agricultural Experiment Stations, and local agencies. The Natural Resources Conservation Service (NRCS) has leadership for the Federal part of the National Cooperative Soil Survey.

Information about soils is updated periodically. Updated information is available through the NRCS Web Soil Survey, the site for official soil survey information.

The U.S. Department of Agriculture (USDA) prohibits discrimination in all its programs and activities on the basis of race, color, national origin, age, disability, and where applicable, sex, marital status, familial status, parental status, religion, sexual orientation, genetic information, political beliefs, reprisal, or because all or a part of an individual's income is derived from any public assistance program. (Not all prohibited bases apply to all programs.) Persons with disabilities who require



alternative means for communication of program information (Braille, large print, audiotape, etc.) should contact USDA's TARGET Center at (202) 720-2600 (voice and TDD). To file a complaint of discrimination, write to USDA, Director, Office of Civil Rights, 1400 Independence Avenue, S.W., Washington, D.C. 20250-9410 or call (800) 795-3272 (voice) or (202) 720-6382 (TDD). USDA is an equal opportunity provider and employer.

# Contents

---

<b>Preface</b> .....	2
<b>How Soil Surveys Are Made</b> .....	5
<b>Soil Map</b> .....	8
Soil Map.....	9
Legend.....	10
Map Unit Legend.....	11
Map Unit Descriptions.....	11
Rockingham County, New Hampshire.....	13
140B—Chatfield-Hollis-Canton complex, 0 to 8 percent slopes, rocky.....	13
799—Urban land-Canton complex, 3 to 15 percent slopes.....	16

# How Soil Surveys Are Made

---

Soil surveys are made to provide information about the soils and miscellaneous areas in a specific area. They include a description of the soils and miscellaneous areas and their location on the landscape and tables that show soil properties and limitations affecting various uses. Soil scientists observed the steepness, length, and shape of the slopes; the general pattern of drainage; the kinds of crops and native plants; and the kinds of bedrock. They observed and described many soil profiles. A soil profile is the sequence of natural layers, or horizons, in a soil. The profile extends from the surface down into the unconsolidated material in which the soil formed or from the surface down to bedrock. The unconsolidated material is devoid of roots and other living organisms and has not been changed by other biological activity.

Currently, soils are mapped according to the boundaries of major land resource areas (MLRAs). MLRAs are geographically associated land resource units that share common characteristics related to physiography, geology, climate, water resources, soils, biological resources, and land uses (USDA, 2006). Soil survey areas typically consist of parts of one or more MLRA.

The soils and miscellaneous areas in a survey area occur in an orderly pattern that is related to the geology, landforms, relief, climate, and natural vegetation of the area. Each kind of soil and miscellaneous area is associated with a particular kind of landform or with a segment of the landform. By observing the soils and miscellaneous areas in the survey area and relating their position to specific segments of the landform, a soil scientist develops a concept, or model, of how they were formed. Thus, during mapping, this model enables the soil scientist to predict with a considerable degree of accuracy the kind of soil or miscellaneous area at a specific location on the landscape.

Commonly, individual soils on the landscape merge into one another as their characteristics gradually change. To construct an accurate soil map, however, soil scientists must determine the boundaries between the soils. They can observe only a limited number of soil profiles. Nevertheless, these observations, supplemented by an understanding of the soil-vegetation-landscape relationship, are sufficient to verify predictions of the kinds of soil in an area and to determine the boundaries.

Soil scientists recorded the characteristics of the soil profiles that they studied. They noted soil color, texture, size and shape of soil aggregates, kind and amount of rock fragments, distribution of plant roots, reaction, and other features that enable them to identify soils. After describing the soils in the survey area and determining their properties, the soil scientists assigned the soils to taxonomic classes (units). Taxonomic classes are concepts. Each taxonomic class has a set of soil characteristics with precisely defined limits. The classes are used as a basis for comparison to classify soils systematically. Soil taxonomy, the system of taxonomic classification used in the United States, is based mainly on the kind and character of soil properties and the arrangement of horizons within the profile. After the soil

## Custom Soil Resource Report

scientists classified and named the soils in the survey area, they compared the individual soils with similar soils in the same taxonomic class in other areas so that they could confirm data and assemble additional data based on experience and research.

The objective of soil mapping is not to delineate pure map unit components; the objective is to separate the landscape into landforms or landform segments that have similar use and management requirements. Each map unit is defined by a unique combination of soil components and/or miscellaneous areas in predictable proportions. Some components may be highly contrasting to the other components of the map unit. The presence of minor components in a map unit in no way diminishes the usefulness or accuracy of the data. The delineation of such landforms and landform segments on the map provides sufficient information for the development of resource plans. If intensive use of small areas is planned, onsite investigation is needed to define and locate the soils and miscellaneous areas.

Soil scientists make many field observations in the process of producing a soil map. The frequency of observation is dependent upon several factors, including scale of mapping, intensity of mapping, design of map units, complexity of the landscape, and experience of the soil scientist. Observations are made to test and refine the soil-landscape model and predictions and to verify the classification of the soils at specific locations. Once the soil-landscape model is refined, a significantly smaller number of measurements of individual soil properties are made and recorded. These measurements may include field measurements, such as those for color, depth to bedrock, and texture, and laboratory measurements, such as those for content of sand, silt, clay, salt, and other components. Properties of each soil typically vary from one point to another across the landscape.

Observations for map unit components are aggregated to develop ranges of characteristics for the components. The aggregated values are presented. Direct measurements do not exist for every property presented for every map unit component. Values for some properties are estimated from combinations of other properties.

While a soil survey is in progress, samples of some of the soils in the area generally are collected for laboratory analyses and for engineering tests. Soil scientists interpret the data from these analyses and tests as well as the field-observed characteristics and the soil properties to determine the expected behavior of the soils under different uses. Interpretations for all of the soils are field tested through observation of the soils in different uses and under different levels of management. Some interpretations are modified to fit local conditions, and some new interpretations are developed to meet local needs. Data are assembled from other sources, such as research information, production records, and field experience of specialists. For example, data on crop yields under defined levels of management are assembled from farm records and from field or plot experiments on the same kinds of soil.

Predictions about soil behavior are based not only on soil properties but also on such variables as climate and biological activity. Soil conditions are predictable over long periods of time, but they are not predictable from year to year. For example, soil scientists can predict with a fairly high degree of accuracy that a given soil will have a high water table within certain depths in most years, but they cannot predict that a high water table will always be at a specific level in the soil on a specific date.

After soil scientists located and identified the significant natural bodies of soil in the survey area, they drew the boundaries of these bodies on aerial photographs and

## Custom Soil Resource Report

identified each as a specific map unit. Aerial photographs show trees, buildings, fields, roads, and rivers, all of which help in locating boundaries accurately.

# Soil Map

---

The soil map section includes the soil map for the defined area of interest, a list of soil map units on the map and extent of each map unit, and cartographic symbols displayed on the map. Also presented are various metadata about data used to produce the map, and a description of each soil map unit.

# Custom Soil Resource Report Soil Map



Map Scale: 1:1,010 if printed on A landscape (11" x 8.5") sheet.

0 10 20 40 60 Meters

0 45 90 180 270 Feet

Map projection: Web Mercator Corner coordinates: WGS84 Edge tics: UTM Zone 19N WGS84



### MAP LEGEND

**Area of Interest (AOI)**

 Area of Interest (AOI)



















**Soils**







 Soil Map Unit Polygons

 Soil Map Unit Lines

 Soil Map Unit Points

**Special Point Features**





-  Blowout
-  Borrow Pit
-  Clay Spot
-  Closed Depression
-  Gravel Pit
-  Gravelly Spot
-  Landfill
-  Lava Flow
-  Marsh or swamp
-  Mine or Quarry
-  Miscellaneous Water
-  Perennial Water
-  Rock Outcrop
-  Saline Spot
-  Sandy Spot
-  Severely Eroded Spot
-  Sinkhole
-  Slide or Slip
-  Sodic Spot

-  Spoil Area
-  Stony Spot
-  Very Stony Spot
-  Wet Spot
-  Other
-  Special Line Features

**Water Features**

 Streams and Canals

**Transportation**

-  Rails
-  Interstate Highways
-  US Routes
-  Major Roads
-  Local Roads

**Background**

 Aerial Photography

### MAP INFORMATION

The soil surveys that comprise your AOI were mapped at 1:24,000.

Warning: Soil Map may not be valid at this scale.

Enlargement of maps beyond the scale of mapping can cause misunderstanding of the detail of mapping and accuracy of soil line placement. The maps do not show the small areas of contrasting soils that could have been shown at a more detailed scale.

Please rely on the bar scale on each map sheet for map measurements.

Source of Map: Natural Resources Conservation Service  
 Web Soil Survey URL:  
 Coordinate System: Web Mercator (EPSG:3857)

Maps from the Web Soil Survey are based on the Web Mercator projection, which preserves direction and shape but distorts distance and area. A projection that preserves area, such as the Albers equal-area conic projection, should be used if more accurate calculations of distance or area are required.

This product is generated from the USDA-NRCS certified data as of the version date(s) listed below.

Soil Survey Area: Rockingham County, New Hampshire  
 Survey Area Data: Version 26, Aug 22, 2023

Soil map units are labeled (as space allows) for map scales 1:50,000 or larger.

Date(s) aerial images were photographed: Jun 19, 2020—Sep 20, 2020

The orthophoto or other base map on which the soil lines were compiled and digitized probably differs from the background imagery displayed on these maps. As a result, some minor shifting of map unit boundaries may be evident.



## Map Unit Legend

Map Unit Symbol	Map Unit Name	Acres in AOI	Percent of AOI
140B	Chatfield-Hollis-Canton complex, 0 to 8 percent slopes, rocky	3.1	83.6%
799	Urban land-Canton complex, 3 to 15 percent slopes	0.6	16.4%
<b>Totals for Area of Interest</b>		<b>3.7</b>	<b>100.0%</b>

## Map Unit Descriptions

The map units delineated on the detailed soil maps in a soil survey represent the soils or miscellaneous areas in the survey area. The map unit descriptions, along with the maps, can be used to determine the composition and properties of a unit.

A map unit delineation on a soil map represents an area dominated by one or more major kinds of soil or miscellaneous areas. A map unit is identified and named according to the taxonomic classification of the dominant soils. Within a taxonomic class there are precisely defined limits for the properties of the soils. On the landscape, however, the soils are natural phenomena, and they have the characteristic variability of all natural phenomena. Thus, the range of some observed properties may extend beyond the limits defined for a taxonomic class. Areas of soils of a single taxonomic class rarely, if ever, can be mapped without including areas of other taxonomic classes. Consequently, every map unit is made up of the soils or miscellaneous areas for which it is named and some minor components that belong to taxonomic classes other than those of the major soils.

Most minor soils have properties similar to those of the dominant soil or soils in the map unit, and thus they do not affect use and management. These are called noncontrasting, or similar, components. They may or may not be mentioned in a particular map unit description. Other minor components, however, have properties and behavioral characteristics divergent enough to affect use or to require different management. These are called contrasting, or dissimilar, components. They generally are in small areas and could not be mapped separately because of the scale used. Some small areas of strongly contrasting soils or miscellaneous areas are identified by a special symbol on the maps. If included in the database for a given area, the contrasting minor components are identified in the map unit descriptions along with some characteristics of each. A few areas of minor components may not have been observed, and consequently they are not mentioned in the descriptions, especially where the pattern was so complex that it was impractical to make enough observations to identify all the soils and miscellaneous areas on the landscape.

The presence of minor components in a map unit in no way diminishes the usefulness or accuracy of the data. The objective of mapping is not to delineate pure taxonomic classes but rather to separate the landscape into landforms or landform segments that have similar use and management requirements. The delineation of such segments on the map provides sufficient information for the

## Custom Soil Resource Report

development of resource plans. If intensive use of small areas is planned, however, onsite investigation is needed to define and locate the soils and miscellaneous areas.

An identifying symbol precedes the map unit name in the map unit descriptions. Each description includes general facts about the unit and gives important soil properties and qualities.

Soils that have profiles that are almost alike make up a *soil series*. Except for differences in texture of the surface layer, all the soils of a series have major horizons that are similar in composition, thickness, and arrangement.

Soils of one series can differ in texture of the surface layer, slope, stoniness, salinity, degree of erosion, and other characteristics that affect their use. On the basis of such differences, a soil series is divided into *soil phases*. Most of the areas shown on the detailed soil maps are phases of soil series. The name of a soil phase commonly indicates a feature that affects use or management. For example, Alpha silt loam, 0 to 2 percent slopes, is a phase of the Alpha series.

Some map units are made up of two or more major soils or miscellaneous areas. These map units are complexes, associations, or undifferentiated groups.

A *complex* consists of two or more soils or miscellaneous areas in such an intricate pattern or in such small areas that they cannot be shown separately on the maps. The pattern and proportion of the soils or miscellaneous areas are somewhat similar in all areas. Alpha-Beta complex, 0 to 6 percent slopes, is an example.

An *association* is made up of two or more geographically associated soils or miscellaneous areas that are shown as one unit on the maps. Because of present or anticipated uses of the map units in the survey area, it was not considered practical or necessary to map the soils or miscellaneous areas separately. The pattern and relative proportion of the soils or miscellaneous areas are somewhat similar. Alpha-Beta association, 0 to 2 percent slopes, is an example.

An *undifferentiated group* is made up of two or more soils or miscellaneous areas that could be mapped individually but are mapped as one unit because similar interpretations can be made for use and management. The pattern and proportion of the soils or miscellaneous areas in a mapped area are not uniform. An area can be made up of only one of the major soils or miscellaneous areas, or it can be made up of all of them. Alpha and Beta soils, 0 to 2 percent slopes, is an example.

Some surveys include *miscellaneous areas*. Such areas have little or no soil material and support little or no vegetation. Rock outcrop is an example.

## Rockingham County, New Hampshire

### 140B—Chatfield-Hollis-Canton complex, 0 to 8 percent slopes, rocky

#### Map Unit Setting

*National map unit symbol:* 2w82m  
*Elevation:* 380 to 1,070 feet  
*Mean annual precipitation:* 36 to 71 inches  
*Mean annual air temperature:* 39 to 55 degrees F  
*Frost-free period:* 145 to 240 days  
*Farmland classification:* Not prime farmland

#### Map Unit Composition

*Chatfield, very stony, and similar soils:* 35 percent  
*Canton, very stony, and similar soils:* 25 percent  
*Hollis, very stony, and similar soils:* 25 percent  
*Minor components:* 15 percent  
*Estimates are based on observations, descriptions, and transects of the mapunit.*

#### Description of Chatfield, Very Stony

##### Setting

*Landform:* Hills, ridges  
*Landform position (two-dimensional):* Summit, shoulder, backslope  
*Landform position (three-dimensional):* Side slope, crest, nose slope  
*Down-slope shape:* Convex  
*Across-slope shape:* Linear, convex  
*Parent material:* Coarse-loamy melt-out till derived from granite, gneiss, and/or schist

##### Typical profile

*Oi - 0 to 1 inches:* slightly decomposed plant material  
*A - 1 to 2 inches:* fine sandy loam  
*Bw - 2 to 30 inches:* gravelly fine sandy loam  
*2R - 30 to 40 inches:* bedrock

##### Properties and qualities

*Slope:* 0 to 8 percent  
*Surface area covered with cobbles, stones or boulders:* 1.6 percent  
*Depth to restrictive feature:* 20 to 41 inches to lithic bedrock  
*Drainage class:* Well drained  
*Runoff class:* High  
*Capacity of the most limiting layer to transmit water (Ksat):* Very low (0.00 to 0.00 in/hr)  
*Depth to water table:* More than 80 inches  
*Frequency of flooding:* None  
*Frequency of ponding:* None  
*Maximum salinity:* Nonsaline (0.0 to 1.9 mmhos/cm)  
*Available water supply, 0 to 60 inches:* Low (about 4.3 inches)

##### Interpretive groups

*Land capability classification (irrigated):* None specified  
*Land capability classification (nonirrigated):* 6s  
*Hydrologic Soil Group:* B  
*Ecological site:* F144AY034CT - Well Drained Till Uplands

## Custom Soil Resource Report

*Hydric soil rating:* No

### Description of Canton, Very Stony

#### Setting

*Landform:* Ridges, hills, moraines

*Landform position (two-dimensional):* Summit, shoulder, backslope

*Landform position (three-dimensional):* Side slope, crest, nose slope

*Down-slope shape:* Convex, linear

*Across-slope shape:* Convex

*Parent material:* Coarse-loamy over sandy melt-out till derived from gneiss, granite, and/or schist

#### Typical profile

*O<sub>i</sub> - 0 to 2 inches:* slightly decomposed plant material

*A - 2 to 5 inches:* fine sandy loam

*Bw<sub>1</sub> - 5 to 16 inches:* fine sandy loam

*Bw<sub>2</sub> - 16 to 22 inches:* gravelly fine sandy loam

*2C - 22 to 67 inches:* gravelly loamy sand

#### Properties and qualities

*Slope:* 0 to 8 percent

*Surface area covered with cobbles, stones or boulders:* 1.6 percent

*Depth to restrictive feature:* 19 to 39 inches to strongly contrasting textural stratification

*Drainage class:* Well drained

*Runoff class:* Low

*Capacity of the most limiting layer to transmit water (K<sub>sat</sub>):* Moderately low to high (0.14 to 14.17 in/hr)

*Depth to water table:* More than 80 inches

*Frequency of flooding:* None

*Frequency of ponding:* None

*Maximum salinity:* Nonsaline (0.0 to 1.9 mmhos/cm)

*Available water supply, 0 to 60 inches:* Low (about 3.4 inches)

#### Interpretive groups

*Land capability classification (irrigated):* None specified

*Land capability classification (nonirrigated):* 6s

*Hydrologic Soil Group:* B

*Ecological site:* F144AY034CT - Well Drained Till Uplands

*Hydric soil rating:* No

### Description of Hollis, Very Stony

#### Setting

*Landform:* Hills, ridges

*Landform position (two-dimensional):* Summit, shoulder, backslope

*Landform position (three-dimensional):* Side slope, crest, nose slope

*Down-slope shape:* Convex

*Across-slope shape:* Linear, convex

*Parent material:* Coarse-loamy melt-out till derived from granite, gneiss, and/or schist

#### Typical profile

*O<sub>i</sub> - 0 to 2 inches:* slightly decomposed plant material

*A - 2 to 7 inches:* gravelly fine sandy loam

*Bw - 7 to 16 inches:* gravelly fine sandy loam

## Custom Soil Resource Report

2R - 16 to 26 inches: bedrock

### Properties and qualities

*Slope:* 0 to 8 percent

*Surface area covered with cobbles, stones or boulders:* 1.6 percent

*Depth to restrictive feature:* 8 to 23 inches to lithic bedrock

*Drainage class:* Somewhat excessively drained

*Runoff class:* Very high

*Capacity of the most limiting layer to transmit water (Ksat):* Very low (0.00 to 0.00 in/hr)

*Depth to water table:* More than 80 inches

*Frequency of flooding:* None

*Frequency of ponding:* None

*Maximum salinity:* Nonsaline (0.0 to 1.9 mmhos/cm)

*Available water supply, 0 to 60 inches:* Very low (about 2.7 inches)

### Interpretive groups

*Land capability classification (irrigated):* None specified

*Land capability classification (nonirrigated):* 6s

*Hydrologic Soil Group:* D

*Ecological site:* F144AY033MA - Shallow Dry Till Uplands

*Hydric soil rating:* No

### Minor Components

#### Freetown

*Percent of map unit:* 5 percent

*Landform:* Swamps, kettles, bogs, depressions, marshes

*Down-slope shape:* Concave

*Across-slope shape:* Concave

*Hydric soil rating:* Yes

#### Newfields, very stony

*Percent of map unit:* 5 percent

*Landform:* Moraines, hills, ground moraines

*Landform position (two-dimensional):* Footslope

*Landform position (three-dimensional):* Base slope

*Down-slope shape:* Linear

*Across-slope shape:* Concave

*Hydric soil rating:* No

#### Walpole, very stony

*Percent of map unit:* 3 percent

*Landform:* Outwash terraces, depressions, outwash plains, depressions, deltas

*Landform position (three-dimensional):* Tread

*Down-slope shape:* Concave

*Across-slope shape:* Concave

*Hydric soil rating:* Yes

#### Rock outcrop

*Percent of map unit:* 2 percent

*Landform:* Hills, ridges

*Hydric soil rating:* Unranked

## 799—Urban land-Canton complex, 3 to 15 percent slopes

### Map Unit Setting

*National map unit symbol:* 9cq0  
*Elevation:* 0 to 1,000 feet  
*Mean annual precipitation:* 42 to 46 inches  
*Mean annual air temperature:* 45 to 48 degrees F  
*Frost-free period:* 120 to 160 days  
*Farmland classification:* Not prime farmland

### Map Unit Composition

*Urban land:* 55 percent  
*Canton and similar soils:* 20 percent  
*Minor components:* 25 percent  
*Estimates are based on observations, descriptions, and transects of the mapunit.*

### Description of Canton

#### Setting

*Parent material:* Till

#### Typical profile

*H1 - 0 to 5 inches:* gravelly fine sandy loam  
*H2 - 5 to 21 inches:* gravelly fine sandy loam  
*H3 - 21 to 60 inches:* loamy sand

#### Properties and qualities

*Slope:* 3 to 8 percent  
*Depth to restrictive feature:* More than 80 inches  
*Drainage class:* Well drained  
*Runoff class:* Low  
*Capacity of the most limiting layer to transmit water (Ksat):* High (2.00 to 6.00 in/hr)  
*Depth to water table:* More than 80 inches  
*Frequency of flooding:* None  
*Frequency of ponding:* None  
*Available water supply, 0 to 60 inches:* Low (about 5.3 inches)

#### Interpretive groups

*Land capability classification (irrigated):* None specified  
*Land capability classification (nonirrigated):* 2e  
*Hydrologic Soil Group:* A  
*Ecological site:* F144AY034CT - Well Drained Till Uplands  
*Hydric soil rating:* No

**Minor Components**

**Udorthents**

*Percent of map unit: 5 percent*  
*Hydric soil rating: No*

**Boxford and eldridge**

*Percent of map unit: 4 percent*  
*Hydric soil rating: No*

**Squamscott and scitico**

*Percent of map unit: 4 percent*  
*Landform: Marine terraces*  
*Hydric soil rating: Yes*

**Scituate and newfields**

*Percent of map unit: 4 percent*  
*Hydric soil rating: No*

**Chatfield**

*Percent of map unit: 4 percent*  
*Hydric soil rating: No*

**Walpole**

*Percent of map unit: 4 percent*  
*Landform: Depressions*  
*Hydric soil rating: Yes*

## Section 7

# BMP Sizing Calculations

## Riprap Sizing Calculations





## FILTRATION PRACTICE DESIGN CRITERIA (Env-Wq 1508.07)

Type/Node Name:

**Bioretention (Raingarden) HydroCAD Node 5-P**

Enter the type of filtration practice (e.g., bioretention system) and the node name in the drainage analysis, if applicable.

yes		Check if you reviewed the restrictions on unlined systems outlined in Env-Wq 1508.07(a).	
0.53	ac	A = Area draining to the practice	
0.24	ac	A <sub>i</sub> = Impervious area draining to the practice	
0.46	decimal	I = Percent impervious area draining to the practice, in decimal form	
0.46	unitless	R <sub>v</sub> = Runoff coefficient = 0.05 + (0.9 x I)	
0.24	ac-in	WQV = 1" x R <sub>v</sub> x A	
887	cf	WQV conversion (ac-in x 43,560 sf/ac x 1ft/12")	
222	cf	25% x WQV (check calc for sediment forebay volume)	
665	cf	75% x WQV (check calc for surface sand filter volume)	
CB's		Method of Pretreatment? (not required for clean or roof runoff)	
	cf	V <sub>SED</sub> = Sediment forebay volume, if used for pretreatment	≥ 25%WQV
Calculate time to drain if system IS NOT underdrained:			
	sf	A <sub>SA</sub> = Surface area of the practice	
	iph	K <sub>sat</sub> <sub>DESIGN</sub> = Design infiltration rate <sup>1</sup>	
		If K <sub>sat</sub> (prior to factor of safety) is < 0.50 iph, has an underdrain been provided?	
	Yes/No	(Use the calculations below)	
-	hours	T <sub>DRAIN</sub> = Drain time = V / (A <sub>SA</sub> * I <sub>DESIGN</sub> )	≤ 72-hrs
Calculate time to drain if system IS underdrained:			
58.60	ft	E <sub>WQV</sub> = Elevation of WQV (attach stage-storage table)	
0.09	cfs	Q <sub>WQV</sub> = Discharge at the E <sub>WQV</sub> (attach stage-discharge table)	
5.47	hours	T <sub>DRAIN</sub> = Drain time = 2WQV/Q <sub>WQV</sub>	≤ 72-hrs
56.50	feet	E <sub>FC</sub> = Elevation of the bottom of the filter course material <sup>2</sup>	
55.83	feet	E <sub>UD</sub> = Invert elevation of the underdrain (UD), if applicable	
-	feet	E <sub>SHWT</sub> = Elevation of SHWT (if none found, enter the lowest elevation of the test pit)	
-	feet	E <sub>ROCK</sub> = Elevation of bedrock (if none found, enter the lowest elevation of the test pit)	
0.67	feet	D <sub>FC to UD</sub> = Depth to UD from the bottom of the filter course	≥ 1'
56.50	feet	D <sub>FC to ROCK</sub> = Depth to bedrock from the bottom of the filter course	≥ 1'
56.50	feet	D <sub>FC to SHWT</sub> = Depth to SHWT from the bottom of the filter course	≥ 1'
59.99	ft	Peak elevation of the 50-year storm event (infiltration can be used in analysis)	
60.00	ft	Elevation of the top of the practice	
YES		50 peak elevation ≤ Elevation of the top of the practice	← yes
<b>If a surface sand filter or underground sand filter is proposed:</b>			
YES	ac	Drainage Area check.	< 10 ac
	cf	V = Volume of storage <sup>3</sup> (attach a stage-storage table)	≥ 75%WQV
	inches	D <sub>FC</sub> = Filter course thickness	18", or 24" if within GPA
Sheet		Note what sheet in the plan set contains the filter course specification.	
	Yes/No	Access grate provided?	← yes



**Stage-Area-Storage for Pond 5-P: Front Raingarden**

Elevation (feet)	Surface (sq-ft)	Wetted (sq-ft)	Storage (cubic-feet)
58.00	1,007	1,007	0
58.05	1,051	1,051	51
58.10	1,095	1,096	105
58.15	1,141	1,142	161
58.20	1,188	1,189	219
58.25	1,235	1,237	280
58.30	1,284	1,286	343
58.35	1,333	1,336	408
58.40	1,383	1,386	476
58.45	1,434	1,438	546
58.50	1,486	1,490	619
58.55	1,540	1,544	695
58.60	1,594	1,598	773
58.65	1,648	1,654	855
58.70	1,704	1,710	938
58.75	1,761	1,767	1,025
58.80	1,819	1,826	1,114
58.85	1,877	1,885	1,207
58.90	1,937	1,945	1,302
58.95	1,998	2,006	1,401
59.00	2,059	2,068	1,502
59.05	2,131	2,140	1,607
59.10	2,204	2,214	1,715
59.15	2,279	2,289	1,827
59.20	2,354	2,365	1,943
59.25	2,431	2,443	2,063
59.30	2,510	2,521	2,186
59.35	2,589	2,601	2,314
59.40	2,670	2,682	2,445
59.45	2,752	2,765	2,581
59.50	2,835	2,848	2,720
59.55	2,919	2,933	2,864
59.60	3,005	3,019	3,012
59.65	3,091	3,107	3,165
59.70	3,180	3,195	3,321
59.75	3,269	3,285	3,483
59.80	3,359	3,376	3,648
59.85	3,451	3,469	3,818
59.90	3,544	3,562	3,993
59.95	3,638	3,657	4,173
60.00	3,734	3,753	4,357
60.05	3,793	3,814	4,545
60.10	3,853	3,874	4,737
60.15	3,913	3,935	4,931
60.20	3,973	3,997	5,128
60.25	4,034	4,059	5,328
60.30	<b>4,096</b>	<b>4,121</b>	<b>5,531</b>

Ewqv= 58.65

**Stage-Discharge for Pond 5-P: Front Raingarden**

Elevation (feet)	Primary (cfs)	Elevation (feet)	Primary (cfs)	Elevation (feet)	Primary (cfs)
58.00	0.00	59.06	0.23	60.12	3.58
58.02	0.06	59.08	0.23	60.14	3.92
58.04	0.06	59.10	0.23	60.16	4.27
58.06	0.07	59.12	0.24	60.18	4.64
58.08	0.07	59.14	0.24	60.20	5.01
58.10	0.08	59.16	0.24	60.22	5.39
58.12	0.08	59.18	0.25	60.24	5.78
58.14	0.09	59.20	0.25	60.26	6.18
58.16	0.10	59.22	0.25	60.28	6.59
58.18	0.10	59.24	0.25	60.30	7.02
58.20	0.10	59.26	0.26	60.32	<b>7.44</b>
58.22	0.11	59.28	0.26		
58.24	0.11	59.30	0.26		
58.26	0.12	59.32	0.26		
58.28	0.12	59.34	0.27		
58.30	0.12	59.36	0.27		
58.32	0.13	59.38	0.27		
58.34	0.13	59.40	0.28		
58.36	0.13	59.42	0.28		
58.38	0.14	59.44	0.28		
58.40	0.14	59.46	0.28		
58.42	0.14	59.48	0.29		
58.44	0.15	59.50	0.29		
58.46	0.15	59.52	0.29		
58.48	0.15	59.54	0.30		
58.50	0.15	59.56	0.30		
58.52	0.16	59.58	0.30		
58.54	0.16	59.60	0.30		
58.56	0.16	59.62	0.31		
58.58	0.17	59.64	0.31		
58.60	0.17	59.66	0.31		
58.62	0.17	59.68	0.32		
58.64	0.17	59.70	0.32		
58.66	0.18	59.72	0.32		
58.68	0.18	59.74	0.32		
58.70	0.18	59.76	0.33		
58.72	0.18	59.78	0.33		
58.74	0.19	59.80	0.33		
58.76	0.19	59.82	0.34		
58.78	0.19	59.84	0.36		
58.80	0.19	59.86	0.45		
58.82	0.20	59.88	0.57		
58.84	0.20	59.90	0.73		
58.86	0.20	59.92	0.91		
58.88	0.20	59.94	1.10		
58.90	0.21	59.96	1.32		
58.92	0.21	59.98	1.55		
58.94	0.21	60.00	1.80		
58.96	0.22	60.02	2.07		
58.98	0.22	60.04	2.34		
59.00	0.22	60.06	2.64		
59.02	0.22	60.08	2.94		
59.04	0.23	60.10	3.26		

Qwqv=0.18



## FILTRATION PRACTICE DESIGN CRITERIA (Env-Wq 1508.07)

Type/Node Name:

**Bioretention (Raingarden #3) HydroCAD Node 6-P**

Enter the type of filtration practice (e.g., bioretention system) and the node name in the drainage analysis, if applicable.

yes	Check if you reviewed the restrictions on unlined systems outlined in Env-Wq 1508.07(a).		
0.49 ac	A = Area draining to the practice		
0.11 ac	$A_i$ = Impervious area draining to the practice		
0.22 decimal	l = Percent impervious area draining to the practice, in decimal form		
0.25 unitless	$R_v$ = Runoff coefficient = $0.05 + (0.9 \times l)$		
0.12 ac-in	WQV = $1'' \times R_v \times A$		
435 cf	WQV conversion (ac-in x 43,560 sf/ac x 1ft/12")		
109 cf	25% x WQV (check calc for sediment forebay volume)		
326 cf	75% x WQV (check calc for surface sand filter volume)		
na	Method of Pretreatment? (not required for clean or roof runoff)		
cf	$V_{SED}$ = Sediment forebay volume, if used for pretreatment		<b>≥ 25%WQV</b>
<b>Calculate time to drain if system IS NOT underdrained:</b>			
sf	$A_{SA}$ = Surface area of the practice		
iph	$K_{sat_{DESIGN}}$ = Design infiltration rate <sup>1</sup>		
	If $K_{sat}$ (prior to factor of safety) is < 0.50 iph, has an underdrain been provided?		
Yes/No	(Use the calculations below)		
- hours	$T_{DRAIN}$ = Drain time = $V / (A_{SA} * I_{DESIGN})$		<b>≤ 72-hrs</b>
<b>Calculate time to drain if system IS underdrained:</b>			
58.10 ft	$E_{WQV}$ = Elevation of WQV (attach stage-storage table)		
0.07 cfs	$Q_{WQV}$ = Discharge at the $E_{WQV}$ (attach stage-discharge table)		
3.45 hours	$T_{DRAIN}$ = Drain time = $2WQV/Q_{WQV}$		<b>≤ 72-hrs</b>
56.25 feet	$E_{FC}$ = Elevation of the bottom of the filter course material <sup>2</sup>		
55.25 feet	$E_{UD}$ = Invert elevation of the underdrain (UD), if applicable		
- feet	$E_{SHWT}$ = Elevation of SHWT (if none found, enter the lowest elevation of the test pit)		
- feet	$E_{ROCK}$ = Elevation of bedrock (if none found, enter the lowest elevation of the test pit)		
1.00 feet	$D_{FC\ to\ UD}$ = Depth to UD from the bottom of the filter course		<b>≥ 1'</b>
56.25 feet	$D_{FC\ to\ ROCK}$ = Depth to bedrock from the bottom of the filter course		<b>≥ 1'</b>
56.25 feet	$D_{FC\ to\ SHWT}$ = Depth to SHWT from the bottom of the filter course		<b>≥ 1'</b>
59.99 ft	Peak elevation of the 50-year storm event (infiltration can be used in analysis)		
60.50 ft	Elevation of the top of the practice		
YES	50 peak elevation ≤ Elevation of the top of the practice		<b>← yes</b>
<b>If a surface sand filter or underground sand filter is proposed:</b>			
YES ac	Drainage Area check.		<b>&lt; 10 ac</b>
cf	V = Volume of storage <sup>3</sup> (attach a stage-storage table)		<b>≥ 75%WQV</b>
inches	$D_{FC}$ = Filter course thickness		<b>18", or 24" if within GPA</b>
Sheet	Note what sheet in the plan set contains the filter course specification.		
Yes/No	Access grate provided?		<b>← yes</b>

If a bioretention area is proposed:			
YES	ac	Drainage Area no larger than 5 ac?	← yes
586	cf	$V$ = Volume of storage <sup>3</sup> (attach a stage-storage table)	≥ WQV
18.0	inches	$D_{FC}$ = Filter course thickness	18", or 24" if within GPA
Sheet	D4	Note what sheet in the plan set contains the filter course specification	
3.0	:1	Pond side slopes	≥ 3:1
Sheet	D1	Note what sheet in the plan set contains the planting plans and surface cover	
If porous pavement is proposed:			
		Type of pavement proposed (Concrete? Asphalt? Pavers? Etc.)	
	acres	$A_{SA}$ = Surface area of the pervious pavement	
	:1	Ratio of the contributing area to the pervious surface area	≤ 5:1
	inches	$D_{FC}$ = Filter course thickness	12", or 18" if within GPA
Sheet		Note what sheet in the plan set contains the filter course spec.	mod. 304.1 (see spec)

1. Rate of the limiting layer (either the filter course or the underlying soil).  $K_{sat\_design}$  includes factor of safety. See Env-Wq 1504.14 for guidance on determining the infiltration rate.
2. See lines 34, 40 and 48 for required depths of filter media.
3. Volume without depending on infiltration. The volume includes the storage above the filter (but below the invert of the outlet structure, if any), the filter media voids, and the pretreatment area. The storage above the filter media shall not include the volume above the outlet structure, if any.

Designer's Notes: 79cf in filter media voids included in WQV calculation.

---



---



---



---



---



---



---



---



---



---



---



---



---



---



---



---



---



---



---



---



---



---



---

**Stage-Area-Storage for Pond 6-P: Southeast Raingarden**

Elevation (feet)	Surface (sq-ft)	Wetted (sq-ft)	Storage (cubic-feet)
57.75	1,059	1,059	0
57.85	1,103	1,104	108
57.95	1,147	1,150	221
58.05	1,194	1,199	338
58.15	1,242	1,249	459
58.25	1,292	1,300	586
58.35	1,342	1,352	718
58.45	1,394	1,405	855
58.55	1,446	1,459	997
58.65	1,500	1,514	1,144
58.75	1,554	1,570	1,297
58.85	1,609	1,627	1,455
58.95	1,666	1,685	1,618
59.05	1,743	1,764	1,788
59.15	1,842	1,864	1,968
59.25	1,944	1,968	2,157
59.35	2,049	2,074	2,357
59.45	2,157	2,183	2,567
59.55	2,267	2,294	2,788
59.65	2,380	2,409	3,020
59.75	2,496	2,526	3,264
59.85	2,615	2,646	3,520
59.95	2,736	2,769	3,787
60.05	2,864	2,898	4,067
60.15	2,999	3,034	4,360
60.25	3,137	3,173	4,667
60.35	3,278	3,316	4,988
60.45	<b>3,422</b>	<b>3,461</b>	<b>5,323</b>
60.55	<b>3,495</b>	<b>3,535</b>	<b>5,496</b>
60.65	3,495	3,535	5,496
60.75	3,495	3,535	5,496
60.85	3,495	3,535	5,496
60.95	3,495	3,535	5,496
61.05	3,495	3,535	5,496
61.15	3,495	3,535	5,496
61.25	3,495	3,535	5,496
61.35	3,495	3,535	5,496
61.45	3,495	3,535	5,496

Ewqv= 58.10

Lowest Outlet= 58.25'  
Available WQV=586cf

**Stage-Discharge for Pond 6-P: Southeast Raingarden**

Elevation (feet)	Primary (cfs)	Elevation (feet)	Primary (cfs)	Elevation (feet)	Primary (cfs)	Elevation (feet)	Primary (cfs)
57.75	0.00	58.81	0.36	59.87	0.66	60.93	7.84
57.77	0.06	58.83	0.36	59.89	0.67	60.95	7.86
57.79	0.06	58.85	0.37	59.91	0.67	60.97	7.88
57.81	0.06	58.87	0.38	59.93	0.68	60.99	7.90
57.83	0.06	58.89	0.38	59.95	0.68	61.01	7.91
57.85	0.06	58.91	0.39	59.97	0.69	61.03	7.93
57.87	0.06	58.93	0.40	59.99	0.69	61.05	7.95
57.89	0.06	58.95	0.40	60.01	0.72	61.07	7.97
57.91	0.07	58.97	0.41	60.03	0.81	61.09	7.99
57.93	0.07	58.99	0.42	60.05	0.93	61.11	8.00
57.95	0.07	59.01	0.42	60.07	1.09	61.13	8.02
57.97	0.07	59.03	0.43	60.09	1.27	61.15	8.04
57.99	0.07	59.05	0.44	60.11	1.47	61.17	8.06
58.01	0.07	59.07	0.44	60.13	1.69	61.19	8.08
58.03	0.07	59.09	0.45	60.15	1.92	61.21	8.09
58.05	0.07	59.11	0.46	60.17	2.17	61.23	8.11
58.07	0.07	59.13	0.46	60.19	2.44	61.25	8.13
58.09	0.07	59.15	0.47	60.21	2.72	61.27	8.15
58.11	0.07	59.17	0.47	60.23	3.01	61.29	8.16
58.13	0.07	59.19	0.48	60.25	3.32	61.31	8.18
58.15	0.07	59.21	0.49	60.27	3.64	61.33	8.20
58.17	0.07	59.23	0.49	60.29	3.97	61.35	8.22
58.19	0.07	59.25	0.50	60.31	4.31	61.37	8.23
58.21	0.07	59.27	0.50	60.33	4.67	61.39	8.25
58.23	0.07	59.29	0.51	60.35	5.03	61.41	8.27
58.25	0.08	59.31	0.51	60.37	5.40	61.43	8.29
58.27	0.08	59.33	0.52	60.39	5.79	61.45	8.30
58.29	0.08	59.35	0.53	60.41	6.18	61.47	8.32
58.31	0.09	59.37	0.53	60.43	6.59	61.49	<b>8.34</b>
58.33	0.09	59.39	0.54	60.45	7.00		
58.35	0.10	59.41	0.54	60.47	7.41		
58.37	0.11	59.43	0.55	60.49	7.43		
58.39	0.12	59.45	0.55	60.51	7.45		
58.41	0.14	59.47	0.56	60.53	7.47		
58.43	0.15	59.49	0.56	60.55	7.49		
58.45	0.16	59.51	0.57	60.57	7.51		
58.47	0.18	59.53	0.57	60.59	7.53		
58.49	0.19	59.55	0.58	60.61	7.54		
58.51	0.21	59.57	0.59	60.63	7.56		
58.53	0.22	59.59	0.59	60.65	7.58		
58.55	0.24	59.61	0.60	60.67	7.60		
58.57	0.25	59.63	0.60	60.69	7.62		
58.59	0.26	59.65	0.61	60.71	7.64		
58.61	0.27	59.67	0.61	60.73	7.66		
58.63	0.28	59.69	0.62	60.75	7.68		
58.65	0.29	59.71	0.62	60.77	7.69		
58.67	0.30	59.73	0.63	60.79	7.71		
58.69	0.31	59.75	0.63	60.81	7.73		
58.71	0.32	59.77	0.64	60.83	7.75		
58.73	0.33	59.79	0.64	60.85	7.77		
58.75	0.33	59.81	0.65	60.87	7.79		
58.77	0.34	59.83	0.65	60.89	7.81		
58.79	0.35	59.85	0.66	60.91	7.82		

Qwqv=0.07



## RIPRAP CALCULATIONS

Project: 5591      Date: 10/23/2024      By: JMG

**Location: Pond #6P, 12" Culvert**

---

La	Apron Length, Ft.	Calculated
<b>Tw</b>	<b>Tailwater, Ft.</b>	<b>0.4</b>
<b>Q</b>	<b>Flow, 10 Yr Storm, CFS</b>	<b>0.7</b>
D50	Median Stone Dia., Ft.	Calculated
D	Depth of Stone, In	Calculated
<b>Do</b>	<b>Pipe Diameter, Ft</b>	<b>1.00</b>
W1	Width @ Start, Ft.	Calculated
W2	Width @ End, Ft	Calculated
<b>W</b>	<b>Width of Channel</b>	<b>6</b>

Width includes bottom and side slopes to 1' depth

W1:

$$3(Do) = 3 \text{ Ft.}$$

<b>Width @ Start:</b>	<b>3 Ft.</b>
-----------------------	--------------

D50:

$$\frac{0.02(Q)^{4/3}}{Tw(Do)}$$

$$D50 = 0.04 \text{ Ft.}$$

or  $0.4 \text{ In.}$

<b>Median Stone Size:</b>	<b>6 In.</b>
---------------------------	--------------

D:

$$2.25 * D50$$

<b>Depth of Riprap:</b>	<b>14 In.</b>
-------------------------	---------------

La:

If  $Tw \leq Do/2$ :

$$La = 1.8Q/Do^{3/2} + 7Do$$

and  $W2 = \text{width of channel}$   
or  
 $W2 = 3Do + La$

$$Do/2 = 0.5 \text{ Ft.}$$

$$Tw = 0.35 \text{ Ft.}$$

If  $Tw > Do/2$ :

$$La = 3Q/Do^{3/2} + 7Do$$

and  $W2 = \text{width of channel}$   
or  
 $W2 = 3Do + 0.4La$

<b>Length of Apron:</b>	<b>9 Ft.</b>
<b>Width @ End:</b>	<b>6 Ft.</b>



## Section 8

# Stormwater Operations & Maintenance Plan

# STORMWATER INSPECTION AND MAINTENANCE MANUAL

**Green and Company**  
Assessor's Map 222, Lot 11  
550 Sagamore Avenue  
Portsmouth, NH

**OWNER:**  
**Green & Company**  
11 Lafayette Road P.O. Box 1297  
North Hampton, NH 03862

Proper inspection, maintenance, and repair are key elements in maintaining a successful stormwater management program on a developed property. Routine inspections ensure permit compliance and reduce the potential for deterioration of infrastructure or reduced water quality. The following responsible parties shall be in charge of managing the stormwater facilities:

## **RESPONSIBLE PARTIES:**

<b>Owner:</b>	<u>Green &amp; Company</u>	<u>603-501-8455</u>
	Name Company	Phone
<b>Inspection:</b>	<u>Green &amp; Company</u>	<u>603-501-8455</u>
	Name Company	Phone
<b>Maintenance:</b>	<u>Green &amp; Company</u>	<u>603-501-8455</u>
	Name Company	Phone

## **NOTES:**

***Written inspection forms and maintenance logs shall be completed yearly by a qualified inspector retained the owner or assigns.***

***Photographs of each stormwater BMP are to be taken at each inspection and submitted with the annual inspection reports.***

***Inspection and maintenance responsibilities shall transfer to any future property owner(s).***

***This manual shall be updated as needed to reflect any changes related to any transfer of ownership and/or any delegation of inspection and maintenance responsibilities to another entity***



## **BIORETENTION PONDS (AKA RAINGARDENS)**

---

*Function* – Bioretention ponds and tree box filters provide treatment to runoff prior to directing it to stormwater systems by filtering sediment and suspended solids, trapping them in the bottom of the facility and in the filter media itself. Additional treatment is provided by the native water-tolerant vegetation which removes nutrients and other pollutants through bio-uptake. Stormwater detention and infiltration can also be provided as the filtering process slows runoff, decreases the peak rate of discharge and promotes groundwater recharge.

Bioretention ponds and tree box filters shall be managed (Per AGR 3800 and RSA 430:53) to: prevent and control the spread of invasive plant, insect, and fungal species; minimize the adverse environmental and economic effects invasive species cause to agriculture, forests, wetlands, wildlife, and other natural resources of the state; and protect the public from potential health problems attributed to certain invasive species.

### *Maintenance*

- Inspect bi-annually and after significant rainfall events.
- If a raingarden or tree box filter does not completely drain within 72-hours following a rainfall event, then a qualified professional shall be retained to assess the condition of the facility to determine measures required to restore its filtration and/or infiltration function(s), including but not limited to removal of accumulated sediments and/or replacement or reconstruction of the filter media. Filter media shall be replaced with material matching the specification on the design drawings or the NHDES Stormwater Manual.
- Replace any riprap dislodged from spillways, inlets and outlets.
- Remove any obstructions, litter and accumulated sediment or debris as warranted but no less than once a year.
- Mowing of any grassed area in or adjacent to a raingarden or tree box filter, including any berms, shall be performed at least twice per year (when areas are not inundated) to keep the vegetation in vigorous condition. The cut grass shall be removed to prevent the decaying organic litter from clogging the filter media or choking other vegetation.
- Select vegetation should be maintained in healthy condition. This may include pruning, removal and replacement of dead or diseased vegetation.
- Remove any invasive species, Per AGR 3800 and RSA 430:53.
- Remove any hard wood growth aside from trees in tree box filters.
- Replace media in tree box filters when replacing tree.

## **CULVERTS AND DRAINAGE PIPES**

---

*Function* – Culverts and drainage pipes convey stormwater away from buildings, walkways, and parking areas and to surface waters or closed drainage systems.

### *Maintenance*

- Culverts and drainage pipes shall be inspected semi-annually, or more often as needed, for accumulation of debris and structural integrity. Leaves and other debris shall be removed from the inlet and outlet to insure the functionality of drainage structures. Debris shall be disposed of on site where it will not concentrate back at the drainage structures or at a solid waste disposal facility.
- Riprap Areas - Culvert outlets and inlets shall be inspected during annual maintenance and operations for erosion and scour. If scour or creek erosion is identified, the outlet owner shall take appropriate means to prevent further erosion. Increased lengths of riprap may require a NHDES Permit and/or local permit.

## **CATCH BASINS**

---

*Function* – Catch basins and field drains collect stormwater, primarily from paved surfaces and roofs. Stormwater from paved areas often contains sediment and contaminants. Sumps serve to trap sediment, trace metals, nutrients and debris. Hooded catch basins trap hydrocarbons and floating debris.

### *Maintenance*

- Remove leaves and debris from structure grates on an as-needed basis.
- Sumps shall be inspected and cleaned annually and any removed sediment and debris shall be disposed of at a solid waste disposal facility.

## **RIP RAP OUTLETS, SWALES AND PLUNGE POOLS**

---

*Function* – Rip rap outlets slow the velocity of runoff, minimizing erosion and maximizing the treatment capabilities of associated buffers. Vegetated buffers, either forested or meadow, slow runoff which promotes and reduces peak rates of runoff. The reduced velocities and the presence of vegetation encourage the filtration of sediment and the limited bio-uptake of nutrients.

### *Maintenance*

- Inspect riprap, level spreaders and buffers at least annually for signs of erosion, sediment buildup, or vegetation loss.
- Inspect level for signs of condensed flows. Level spreader and rip rap shall be maintained to disperse flows evenly over level spreader.
- If a meadow buffer, provide periodic mowing as needed to maintain a healthy stand of herbaceous vegetation.
- If a forested buffer, then the buffer should be maintained in an undisturbed condition, unless erosion occurs.
- If erosion of the buffer (forested or meadow) occurs, eroded areas should be repaired and replanted with vegetation similar to the remaining buffer. Corrective action should include eliminating the source of the erosion problem and may require retrofit or reconstruction of the level spreader.
- Remove debris and accumulated sediment and dispose of properly.

## **LANDSCAPED AREAS – ORGANIC FERTILIZER MANAGEMENT**

---

*Function* – All fertilizer used on site shall be certified organic. Organic fertilizer management involves controlling the rate, timing and method of organic fertilizer application so that the nutrients are taken up by the plants thereby reducing the chance of polluting the surface and ground waters. Organic fertilizer management can be effective in reducing the amounts of phosphorus and nitrogen in runoff from landscaped areas, particularly lawns.

### *Maintenance*

- Have the soil tested by your landscaper or local Soil Conservation Service for nutrient requirements and follow the recommendations.
- Do not apply organic fertilizer to frozen ground.
- Clean up any organic fertilizer spills.
- Do not allow organic fertilizer to be broadcast into water bodies.
- When organically fertilizing a lawn, water thoroughly, but do not create a situation where water runs off the surface of the lawn.

## **LANDSCAPED AREAS - LITTER CONTROL**

---

*Function* – Landscaped areas tend to filter debris and contaminates that may block drainage systems and pollute the surface and ground waters.

*Maintenance*

- Litter Control and lawn maintenance involves removing litter such as trash, leaves, lawn clippings, pet wastes, oil and chemicals from streets, parking lots, and lawns before materials are transported into surface waters.
- Litter control shall be implemented as part of the grounds maintenance program.

## **VEGETATIVE SWALES**

---

*Function* – Vegetative swales filter sediment from stormwater, promote infiltration, and the uptake of contaminates. They are designed to treat runoff and dispose of it safely into the natural drainage system.

*Maintenance*

- Timely maintenance is important to keep a swale in good working condition. Mowing of grassed swales shall be monthly to keep the vegetation in vigorous condition. The cut vegetation shall be removed to prevent the decaying organic litter from adding pollutants to the discharge from the swale.
- Fertilizing shall be bi-annual or as recommended from soil testing.
- Inspect swales following significant rainfall events.
- Woody vegetation shall not be allowed to become established in the swales or rock riprap outlet protection and if present shall be removed.
- Accumulated debris disrupts flow and leads to clogging and erosion. Remove debris and litter as necessary.
- Inspect for eroded areas. Determine cause of erosion and correct deficiency as required. Monitor repaired areas.

## **CONTROL OF INVASIVE PLANTS**

---

*Function* – Invasive plants are introduced, alien, or non-native plants, which have been moved by people from their native habitat to a new area. Some exotic plants are imported for human use such as landscaping, erosion control, or food crops. They also can arrive as "hitchhikers" among shipments of other plants, seeds, packing materials, or fresh produce. Some exotic plants become invasive and cause harm by:

- becoming weedy and overgrown;
- killing established shade trees;
- obstructing pipes and drainage systems;
- forming dense beds in water;
- lowering water levels in lakes, streams, and wetlands;
- destroying natural communities;
- promoting erosion on stream banks and hillsides; and
- resisting control except by hazardous chemical.

*Maintenance*

During maintenance activities, check for the presence of invasive plants and remove in a safe manner as described in the attached “Methods for Disposing Non-Native Invasive Plants” prepared by the UNH Cooperative Extension.

**GENERAL CLEAN UP**

---

- Upon completion of the project, the contractor shall remove all temporary stormwater structures (i.e., temporary stone check dams, silt fence, temporary diversion swales, catch basin inlet filter, etc.). Any sediment deposits remaining in place after the silt fence or filter barrier is no longer required shall be dressed to conform to the existing grade, prepared, and seeded. Remove any sediment in catch basins and clean drain pipes that may have accumulated during construction.
- Once in operation, all paved areas of the site should be swept at least once annually at the end of winter/early spring prior to significant spring rains.

**SNOW MANAGEMENT**

---

Snow should never be stored in any stormwater practice as it may affect functionality by blocking drains and reducing the storage volume available for runoff. The Owner/Applicant and any maintenance personnel should take great care to ensure that snow is stored only in areas depicted on the site plan and away from locations that could negatively impact drainage infrastructure or flow paths.

**APPENDIX**

---

- A. Stormwater System Operations and Maintenance Report
- B. Site Grading and Drainage Plan

## STORM WATER SYSTEM OPERATION AND MAINTENANCE REPORT

General Information		
<b>Project Name</b>		
<b>Owner</b>		
<b>Inspector's Name(s)</b>		
<b>Inspector's Contact Information</b>		
<b>Date of Inspection</b>	<b>Start Time:</b>	<b>End Time:</b>
<b>Type of Inspection:</b> <input type="checkbox"/> Annual Report <input type="checkbox"/> Post-storm event <input type="checkbox"/> Due to a discharge of significant amounts of sediment		
<b>Notes:</b>		

General Site Questions and Discharges of Significant Amounts of Sediment		
Subject	Status	Notes
<i>A discharge of significant amounts of sediment may be indicated by (but is not limited to) observations of the following. Note whether any are observed during this inspection:</i>		
<i>Notes/ Action taken:</i>		
1	Do the current site conditions reflect the attached site plan?	<input type="checkbox"/> Yes <input type="checkbox"/> No
2	Is the site permanently stabilized, temporary erosion and sediment controls are removed, and stormwater discharges from construction activity are eliminated?	<input type="checkbox"/> Yes <input type="checkbox"/> No
3	Is there evidence of the discharge of significant amounts of sediment to surface waters, or conveyance systems leading to surface waters?	<input type="checkbox"/> Yes <input type="checkbox"/> No

Permit Coverage and Plans				
#	BMP/Facility	Inspected	Corrective Action Needed and Notes	Date Corrected
	Bioretention Ponds	<input type="checkbox"/> Yes <input type="checkbox"/> No		
	Catch Basins	<input type="checkbox"/> Yes <input type="checkbox"/> No		
	Drainage Pipes	<input type="checkbox"/> Yes <input type="checkbox"/> No		
	Riprap Aprons/Plunge Pools	<input type="checkbox"/> Yes <input type="checkbox"/> No		
	Site Vegetation	<input type="checkbox"/> Yes <input type="checkbox"/> No		
		<input type="checkbox"/> Yes <input type="checkbox"/> No		
		<input type="checkbox"/> Yes <input type="checkbox"/> No		

- INSPECTOR TO TAKE REPRESENTATIVE PHOTOGRAPHS OF EACH BMP INSPECTED AND INCLUDE THEM IN THE ANNUAL INSPECTION REPORT.



# Section 9

## Watershed Plans

Pre-Development Drainage Plan

Post-Development Drainage Plan



SAGAMORE AVENUE

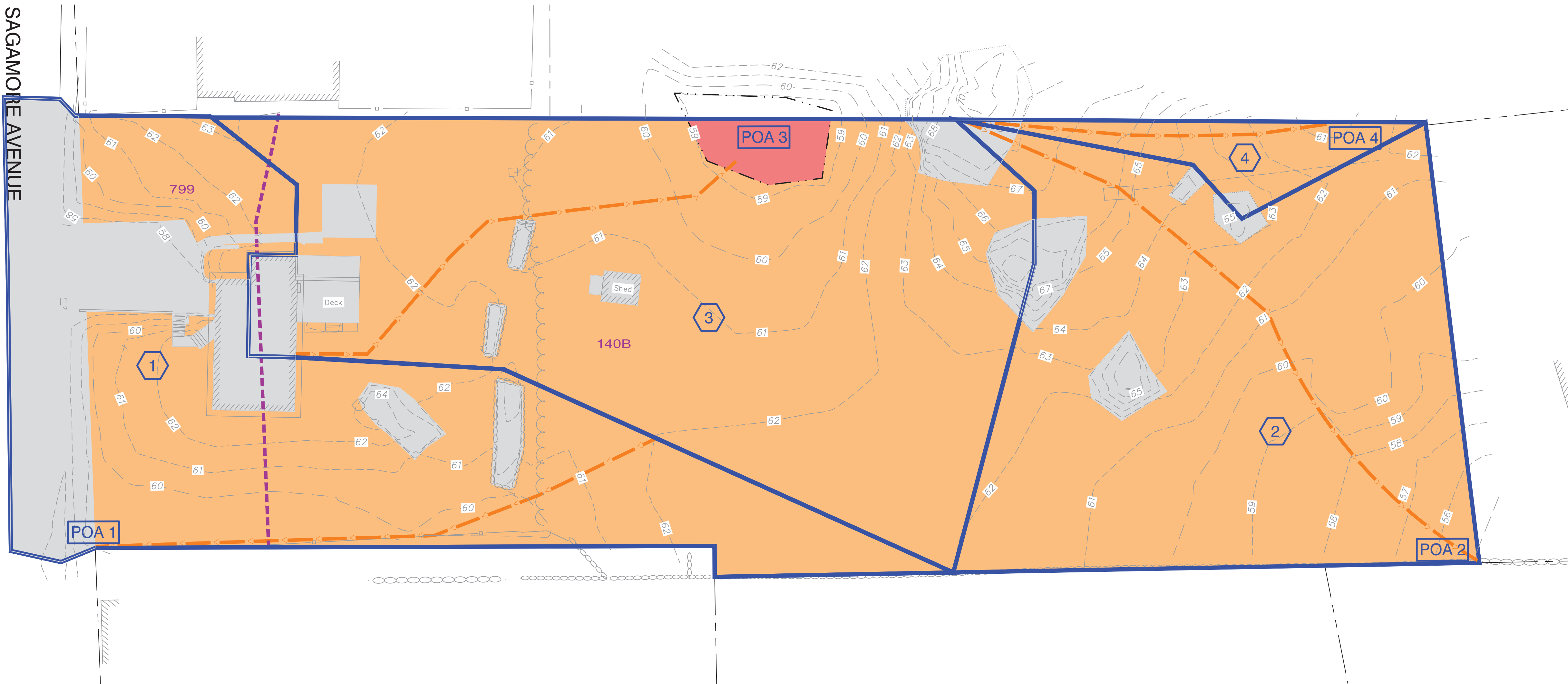

**LEGEND**

- PROPERTY LINE
- WETLAND BOUNDARY
- EXISTING CONTOUR
- WATERSHED BOUNDARY
- Tc PATH
- SCS SOIL BOUNDARY
- 140B SCS SOIL DESIGNATION
- SOILS - HSG C
- SOILS - HSG D
- SOILS - IMPERVIOUS
- SUBCATCHMENT/POND/REACH
- POA POINT OF ANALYSIS

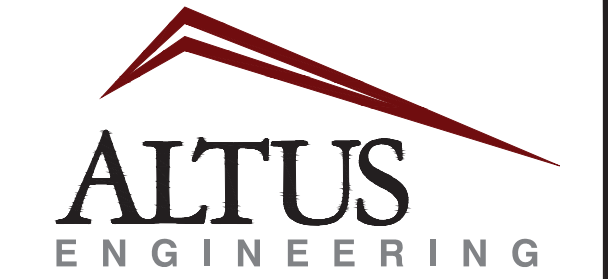
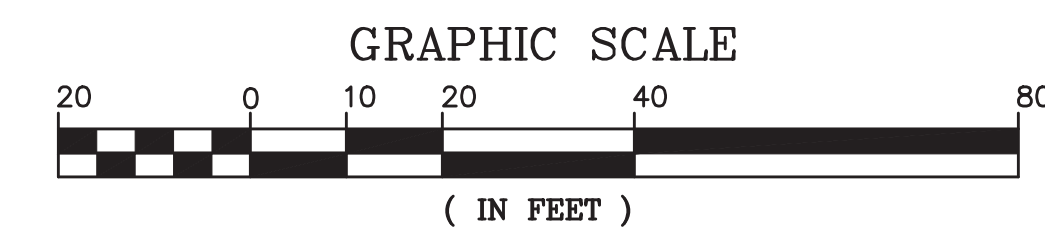

133 Court Street Portsmouth, NH 03801  
(603) 433-2335 www.altus-eng.com

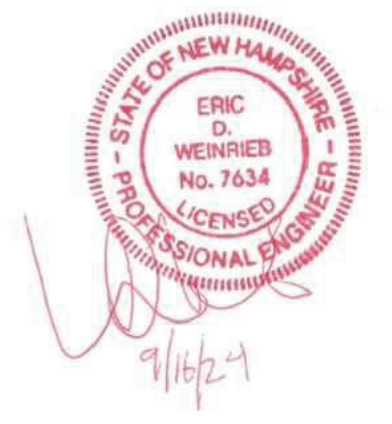

NOT FOR CONSTRUCTION

ISSUED FOR: TAC APPLICATION

ISSUE DATE: SEPTEMBER 16, 2024

NO.	DESCRIPTION	BY	DATE
0	INITIAL SUBMISSION	EDW	09/16/24

DRAWN BY: JMC  
APPROVED BY: EDW  
DRAWING FILE: 5591C0-1.dwg

SCALE:  
22" x 34" - 1" = 20'  
11" x 17" - 1" = 40'

OWNER:  
FRANCES E. MOUFLOUZE,  
TED W. ALEX &  
PATRICIA CAMERON, TRUSTEES  
  
THE FRANCES E. MOUFLOUZE  
REVOCABLE TRUST OF 2015  
104 LOCKE RD  
RYE, NH 03870

APPLICANT:  
GREEN & COMPANY  
11 LAFAYETTE ROAD  
P.O. BOX 1297  
NORTH HAMPTON, NH 03862

PROJECT:  
RESIDENTIAL  
DEVELOPMENT  
  
TAX MAP 222 LOT 11  
550 SAGAMORE AVENUE  
PORTSMOUTH, NH

TITLE:  
PRE-DEVELOPMENT  
WATERSHED PLAN

SHEET NUMBER:  
WS - 1

P5591

NHSPC (MAD83)

SAGAMORE AVENUE

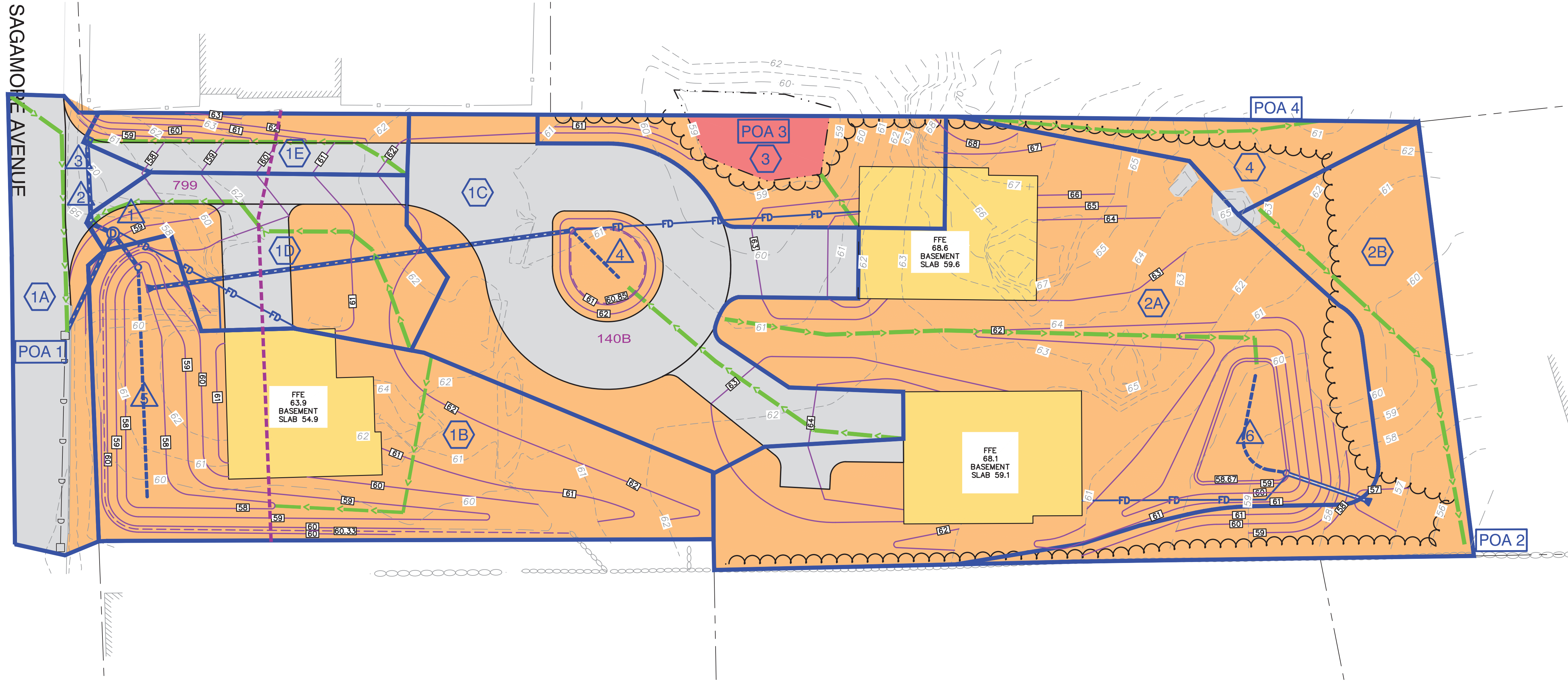

**LEGEND**

- PROPERTY LINE
- - - WETLAND BOUNDARY
- 60 --- EXISTING CONTOUR
- - - 60 - - - PROPOSED CONTOUR
- WATERSHED BOUNDARY
- Tc PATH
- SCS SOIL BOUNDARY
- 140B
- SOILS - HSG C
- SOILS - HSG D
- SOILS - IMPERVIOUS
- SOILS - PROPOSED BUILDING
- 1 1 1 SUBCATCHMENT/POND/REACH
- POA POINT OF ANALYSIS

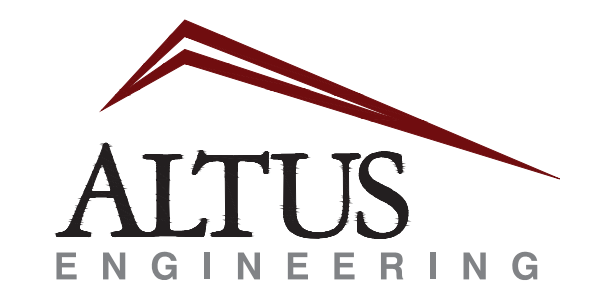
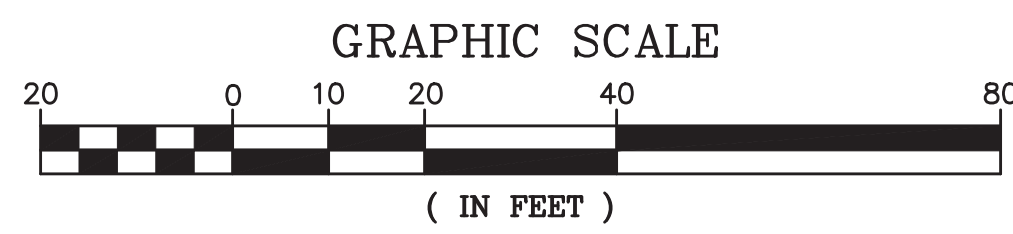

133 Court Street Portsmouth, NH 03801  
(603) 433-2335 www.altus-eng.com

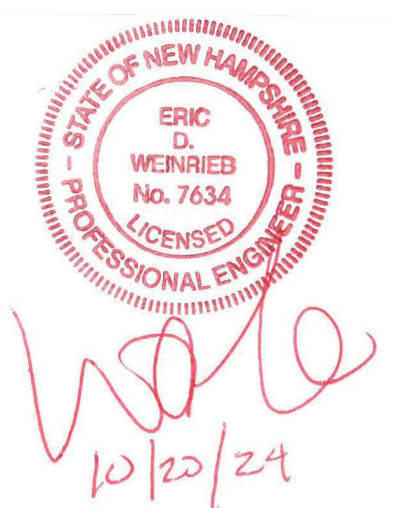

NOT FOR CONSTRUCTION

ISSUED FOR: TAC APPLICATION

ISSUE DATE: OCTOBER 23, 2024

NO.	DESCRIPTION	BY	DATE
0	INITIAL SUBMISSION	EDW	09/16/24
1	PER TAC COMMENTS	EDW	10/23/24

DRAWN BY: JMC  
APPROVED BY: EDW  
DRAWING FILE: 5591C0-1.dwg

SCALE:  
22" x 34" - 1" = 20'  
11" x 17" - 1" = 40'

OWNER:  
FRANCES E. MOUFLOUZE,  
TED W. ALEX &  
PATRICIA CAMERON, TRUSTEES  
  
THE FRANCES E. MOUFLOUZE  
REVOCABLE TRUST OF 2015  
104 LOCKE RD  
RYE, NH 03870

APPLICANT:  
GREEN & COMPANY  
11 LAFAYETTE ROAD  
P.O. BOX 1297  
NORTH HAMPTON, NH 03862

PROJECT:  
RESIDENTIAL  
DEVELOPMENT  
  
TAX MAP 222 LOT 11  
550 SAGAMORE AVENUE  
PORTSMOUTH, NH

TITLE:  
POST DEVELOPMENT  
WATERSHED

SHEET NUMBER:  
WS-2

P5591

**eric weinrieb**

---

**From:** Eric B. Eby <ebeby@cityofportsmouth.com>  
**Sent:** Wednesday, August 14, 2024 1:26 PM  
**To:** eric weinrieb  
**Subject:** Fwd: Sagamore Ave Speeds  
**Attachments:** Sagamore Ave South of Sagamore Court Entrance-Speed.pdf

Eric

Attached is the speed data we collected on Sagamore Ave at the site driveway. Northbound 85th percentile speeds were recorded at 29 mph. They would be expected to increase slightly, another 1 or 2 mph, when the road is repaved. My recommendation would be to remove any trees or vegetation in or hanging over the Sagamore ROW between the driveway and the curve to maximize sight lines at the driveway. But I don't know where current trees and vegetation are located with respect to the ROW.

Eric Eby, P.E.  
City Engineer - Parking, Transportation and Planning  
Department of Public Works  
City of Portsmouth  
603-766-1415

---

**From:** Tyler C. Reese <tcreese@cityofportsmouth.com>  
**Sent:** Tuesday, August 13, 2024 10:02:47 AM  
**To:** Eric B. Eby <ebeby@cityofportsmouth.com>  
**Subject:** Sagamore Ave Speeds

Eric,

Please see the attached Saturday and Sunday speeds for Sagamore Avenue. Let me know if there is anything else you need.

Tyler

City of Portsmouth  
 Department of Public Works  
 Parking Division  
 Traffic Engineering



Station ID: Sagamore Ave South of Sagamore  
 Court Entrance

Direction: SB, 1

8/10/2024	> 3 - 6	> 6 - 9	> 9 - 12	> 12 - 15	> 15 - 18	> 18 - 21	> 21 - 24	> 24 - 27	> 27 - 30	> 30 - 33	> 33 - 36	> 36 - 39	> 39 MPH	85th %ile	
Time	0 - 3 MPH	MPH	MPH	MPH	MPH	MPH	MPH	MPH	MPH	MPH	MPH	MPH	MPH		
12:00 AM	*	*	*	*	*	*	*	*	*	*	*	*	*	*	
1:00	0	0	0	0	0	0	2	0	3	3	2	1	1	34	
2:00	0	0	0	0	0	0	0	0	2	0	1	1	0	36	
3:00	0	0	0	0	0	0	0	1	0	1	0	0	0	28	
4:00	0	0	0	0	0	0	0	0	2	1	0	0	0	30	
5:00	0	0	0	0	0	0	0	3	5	2	0	2	0	31	
6:00	0	0	0	0	0	2	4	6	12	7	7	4	0	34	
7:00	0	0	0	0	1	2	1	5	10	29	34	14	5	32	
8:00	0	0	0	0	1	2	4	6	32	60	48	18	7	31	
9:00	0	0	0	0	2	4	5	24	59	78	61	27	1	31	
10:00	0	0	0	1	1	2	8	16	50	111	84	24	4	30	
11:00	0	0	2	4	8	7	16	30	66	106	84	21	3	30	
12:00 PM	0	0	0	0	4	4	0	20	55	120	99	35	8	31	
1:00	0	0	0	1	1	5	7	22	78	138	82	32	5	31	
2:00	0	0	0	0	3	1	7	37	88	126	92	47	8	31	
3:00	0	0	0	2	0	1	15	44	131	133	81	22	11	30	
4:00	0	0	1	1	1	8	11	20	71	155	105	42	8	31	
5:00	0	0	0	1	2	2	9	20	67	146	96	35	5	31	
6:00	0	0	0	3	0	2	12	22	58	191	105	24	5	31	
7:00	0	0	0	0	1	1	1	15	70	101	73	30	4	31	
8:00	0	0	0	1	0	1	5	25	73	78	36	19	8	31	
9:00	0	0	0	0	0	2	7	18	38	68	34	12	2	30	
10:00	0	0	0	0	0	2	0	6	17	33	28	8	4	31	
11:00	0	0	0	0	1	0	1	3	9	23	21	7	3	32	
Total	0	0	3	14	26	46	111	339	982	1720	1177	427	99	11	718

City of Portsmouth  
 Department of Public Works  
 Parking Division  
 Traffic Engineering



Station ID: Sagamore Ave South of Sagamore Court Entrance

Direction: SB, 1

8/11/2024	> 3 - 6 MPH	> 6 - 9 MPH	> 9 - 12 MPH	> 12 - 15 MPH	> 15 - 18 MPH	> 18 - 21 MPH	> 21 - 24 MPH	> 24 - 27 MPH	> 27 - 30 MPH	> 30 - 33 MPH	> 33 - 36 MPH	> 36 - 39 MPH	> 39 MPH	85th %ile	
12:00 AM	0	0	0	0	0	0	2	5	7	8	7	1	2	0	
1:00	*	*	*	*	*	*	*	*	*	*	*	*	*	*	
2:00	*	*	*	*	*	*	*	*	*	*	*	*	*	*	
3:00	*	*	*	*	*	*	*	*	*	*	*	*	*	*	
4:00	*	*	*	*	*	*	*	*	*	*	*	*	*	*	
5:00	*	*	*	*	*	*	*	*	*	*	*	*	*	*	
6:00	*	*	*	*	*	*	*	*	*	*	*	*	*	*	
7:00	*	*	*	*	*	*	*	*	*	*	*	*	*	*	
8:00	*	*	*	*	*	*	*	*	*	*	*	*	*	*	
9:00	*	*	*	*	*	*	*	*	*	*	*	*	*	*	
10:00	*	*	*	*	*	*	*	*	*	*	*	*	*	*	
11:00	*	*	*	*	*	*	*	*	*	*	*	*	*	*	
12:00 PM	*	*	*	*	*	*	*	*	*	*	*	*	*	*	
1:00	*	*	*	*	*	*	*	*	*	*	*	*	*	*	
2:00	*	*	*	*	*	*	*	*	*	*	*	*	*	*	
3:00	*	*	*	*	*	*	*	*	*	*	*	*	*	*	
4:00	*	*	*	*	*	*	*	*	*	*	*	*	*	*	
5:00	*	*	*	*	*	*	*	*	*	*	*	*	*	*	
6:00	*	*	*	*	*	*	*	*	*	*	*	*	*	*	
7:00	*	*	*	*	*	*	*	*	*	*	*	*	*	*	
8:00	*	*	*	*	*	*	*	*	*	*	*	*	*	*	
9:00	*	*	*	*	*	*	*	*	*	*	*	*	*	*	
10:00	*	*	*	*	*	*	*	*	*	*	*	*	*	*	
11:00	*	*	*	*	*	*	*	*	*	*	*	*	*	*	
Total	0	0	0	0	0	0	2	5	7	8	7	1	2	0	
Stats	Percentile		15th	50th	85th	95th									
	Speed		24	28	32	34									
	Mean Speed (Average)		29.0												
	10 MPH Pace Speed		25-34												
	Number in Pace		4027												
	Percent in Pace		81.0%												
	Number > 45 MPH		0												
	Percent > 45 MPH		0.0%												
Grand Total	0	0	3	14	26	46	111	341	987	1727	1185	434	100	13	718

City of Portsmouth  
 Department of Public Works  
 Parking Division  
 Traffic Engineering



Station ID: Sagamore Ave South of Sagamore Court Entrance

Direction: NB, 2

8/10/2024	> 3 - 6 MPH	> 6 - 9 MPH	> 9 - 12 MPH	> 12 - 15 MPH	> 15 - 18 MPH	> 18 - 21 MPH	> 21 - 24 MPH	> 24 - 27 MPH	> 27 - 30 MPH	> 30 - 33 MPH	> 33 - 36 MPH	> 36 - 39 MPH	> 39 MPH	85th %ile	
12:00 AM	*	*	*	*	*	*	*	*	*	*	*	*	*	*	
1:00	0	0	0	0	0	0	0	2	6	4	2	1	0	34	
2:00	0	0	0	0	0	0	1	0	1	1	0	0	0	36	
3:00	0	0	0	0	0	0	0	0	2	0	0	0	0	28	
4:00	0	0	0	0	0	0	0	1	2	0	0	0	0	30	
5:00	0	0	0	0	0	0	1	3	4	2	0	0	0	31	
6:00	0	0	0	0	0	0	1	7	16	6	1	2	0	34	
7:00	0	0	0	0	0	0	3	14	34	29	11	4	0	32	
8:00	0	0	0	0	0	2	4	21	62	50	17	0	0	31	
9:00	0	0	0	0	1	10	14	52	105	66	15	7	0	31	
10:00	0	0	0	0	0	5	19	59	116	93	34	5	1	30	
11:00	0	0	0	2	2	5	14	47	144	134	50	5	3	30	
12:00 PM	0	0	0	1	1	3	15	52	140	126	47	13	2	31	
1:00	0	0	0	0	0	8	10	51	148	101	41	9	1	31	
2:00	0	0	0	0	0	2	10	56	112	102	25	6	0	31	
3:00	0	0	0	0	2	3	14	51	129	92	31	4	0	30	
4:00	0	0	0	0	0	6	13	71	123	95	27	7	2	31	
5:00	0	0	0	1	0	2	8	62	109	78	28	1	2	31	
6:00	0	0	0	0	2	1	5	30	116	66	28	5	0	31	
7:00	0	0	0	0	1	3	4	37	88	73	25	4	0	31	
8:00	0	0	0	1	0	0	5	31	71	58	12	6	3	31	
9:00	0	0	0	0	0	1	4	21	55	49	13	1	0	30	
10:00	0	0	0	0	0	1	7	13	40	31	19	1	1	31	
11:00	0	0	0	0	0	0	0	4	10	24	16	1	1	32	
Total	0	0	0	5	9	52	150	681	1624	1296	452	82	19	5	718

City of Portsmouth  
 Department of Public Works  
 Parking Division  
 Traffic Engineering



Station ID: Sagamore Ave South of Sagamore  
 Court Entrance

Direction: NB, 2

8/11/2024	> 3 - 6 MPH	> 6 - 9 MPH	> 9 - 12 MPH	> 12 - 15 MPH	> 15 - 18 MPH	> 18 - 21 MPH	> 21 - 24 MPH	> 24 - 27 MPH	> 27 - 30 MPH	> 30 - 33 MPH	> 33 - 36 MPH	> 36 - 39 MPH	> 39 MPH	85th %ile	
Time	0 - 3 MPH														
12:00 AM	0	0	0	0	0	0	2	8	9	7	3	0	0	0	
1:00	*	*	*	*	*	*	*	*	*	*	*	*	*	*	
2:00	*	*	*	*	*	*	*	*	*	*	*	*	*	*	
3:00	*	*	*	*	*	*	*	*	*	*	*	*	*	*	
4:00	*	*	*	*	*	*	*	*	*	*	*	*	*	*	
5:00	*	*	*	*	*	*	*	*	*	*	*	*	*	*	
6:00	*	*	*	*	*	*	*	*	*	*	*	*	*	*	
7:00	*	*	*	*	*	*	*	*	*	*	*	*	*	*	
8:00	*	*	*	*	*	*	*	*	*	*	*	*	*	*	
9:00	*	*	*	*	*	*	*	*	*	*	*	*	*	*	
10:00	*	*	*	*	*	*	*	*	*	*	*	*	*	*	
11:00	*	*	*	*	*	*	*	*	*	*	*	*	*	*	
12:00 PM	*	*	*	*	*	*	*	*	*	*	*	*	*	*	
1:00	*	*	*	*	*	*	*	*	*	*	*	*	*	*	
2:00	*	*	*	*	*	*	*	*	*	*	*	*	*	*	
3:00	*	*	*	*	*	*	*	*	*	*	*	*	*	*	
4:00	*	*	*	*	*	*	*	*	*	*	*	*	*	*	
5:00	*	*	*	*	*	*	*	*	*	*	*	*	*	*	
6:00	*	*	*	*	*	*	*	*	*	*	*	*	*	*	
7:00	*	*	*	*	*	*	*	*	*	*	*	*	*	*	
8:00	*	*	*	*	*	*	*	*	*	*	*	*	*	*	
9:00	*	*	*	*	*	*	*	*	*	*	*	*	*	*	
10:00	*	*	*	*	*	*	*	*	*	*	*	*	*	*	
11:00	*	*	*	*	*	*	*	*	*	*	*	*	*	*	
Total	0	0	0	0	0	0	2	8	9	7	3	0	0	0	
Stats		Percentile	15th	50th	85th	95th									
		Speed	23	26	29	31									
		Mean Speed (Average)	26.9												
		10 MPH Pace Speed	22-31												
		Number in Pace	3761												
		Percent in Pace	86.0%												
		Number > 45 MPH	0												
		Percent > 45 MPH	0.0%												
Grand Total	0	0	0	5	9	52	150	683	1632	1305	459	85	19	5	718



City of Portsmouth  
 Department of Public Works  
 Parking Division  
 Traffic Engineering



Station ID: Sagamore Ave South of Sagamore Court Entrance

Direction: Combined

8/10/2024	> 3 - 6 MPH	> 6 - 9 MPH	> 9 - 12 MPH	> 12 - 15 MPH	> 15 - 18 MPH	> 18 - 21 MPH	> 21 - 24 MPH	> 24 - 27 MPH	> 27 - 30 MPH	> 30 - 33 MPH	> 33 - 36 MPH	> 36 - 39 MPH	> 39 MPH	85th %ile	
12:00 AM	*	*	*	*	*	*	*	*	*	*	*	*	*	*	
1:00	0	0	0	0	0	0	2	2	9	7	4	2	1	34	
2:00	0	0	0	0	0	0	1	0	3	1	1	1	0	36	
3:00	0	0	0	0	0	0	0	1	2	1	0	0	0	28	
4:00	0	0	0	0	0	0	0	1	4	1	0	0	0	30	
5:00	0	0	0	0	0	0	1	6	9	4	0	2	0	31	
6:00	0	0	0	0	0	3	11	22	26	13	8	6	0	34	
7:00	0	0	0	0	1	2	4	19	44	58	18	5	0	32	
8:00	0	0	0	0	1	4	8	27	94	110	65	18	7	31	
9:00	0	0	0	0	3	14	19	76	164	144	76	34	1	2	31
10:00	0	0	0	1	1	7	27	75	166	204	118	29	5	1	30
11:00	0	0	2	6	10	12	30	77	210	240	134	26	6	1	30
12:00 PM	0	0	0	1	5	7	15	72	195	246	146	48	10	0	31
1:00	0	0	0	1	1	13	17	73	226	239	123	41	6	1	31
2:00	0	0	0	0	3	3	17	93	200	228	117	53	8	1	31
3:00	0	0	0	2	2	4	29	95	260	225	112	26	11	2	30
4:00	0	0	1	1	1	14	24	91	194	250	132	49	10	0	31
5:00	0	0	0	2	2	4	17	82	176	224	124	36	7	3	31
6:00	0	0	0	3	2	3	17	52	174	257	133	29	5	1	31
7:00	0	0	0	0	2	4	5	52	158	174	98	34	4	0	31
8:00	0	0	0	2	0	1	10	56	144	136	48	25	11	0	31
9:00	0	0	0	0	0	3	11	39	93	117	47	13	2	0	30
10:00	0	0	0	0	0	3	7	19	57	64	47	9	5	1	31
11:00	0	0	0	0	1	0	1	7	19	47	37	8	4	1	32
Total	0	0	3	19	35	98	261	1020	2606	3016	1629	509	118	16	718

City of Portsmouth  
 Department of Public Works  
 Parking Division  
 Traffic Engineering



Station ID: Sagamore Ave South of Sagamore Court Entrance

Direction: Combined

8/11/2024	> 3 - 6 MPH	> 6 - 9 MPH	> 9 - 12 MPH	> 12 - 15 MPH	> 15 - 18 MPH	> 18 - 21 MPH	> 21 - 24 MPH	> 24 - 27 MPH	> 27 - 30 MPH	> 30 - 33 MPH	> 33 - 36 MPH	> 36 - 39 MPH	> 39 MPH	85th %ile	
Time	0 - 3 MPH														
12:00 AM	0	0	0	0	0	0	4	13	16	15	10	1	2	0	
1:00	*	*	*	*	*	*	*	*	*	*	*	*	*	*	
2:00	*	*	*	*	*	*	*	*	*	*	*	*	*	*	
3:00	*	*	*	*	*	*	*	*	*	*	*	*	*	*	
4:00	*	*	*	*	*	*	*	*	*	*	*	*	*	*	
5:00	*	*	*	*	*	*	*	*	*	*	*	*	*	*	
6:00	*	*	*	*	*	*	*	*	*	*	*	*	*	*	
7:00	*	*	*	*	*	*	*	*	*	*	*	*	*	*	
8:00	*	*	*	*	*	*	*	*	*	*	*	*	*	*	
9:00	*	*	*	*	*	*	*	*	*	*	*	*	*	*	
10:00	*	*	*	*	*	*	*	*	*	*	*	*	*	*	
11:00	*	*	*	*	*	*	*	*	*	*	*	*	*	*	
12:00 PM	*	*	*	*	*	*	*	*	*	*	*	*	*	*	
1:00	*	*	*	*	*	*	*	*	*	*	*	*	*	*	
2:00	*	*	*	*	*	*	*	*	*	*	*	*	*	*	
3:00	*	*	*	*	*	*	*	*	*	*	*	*	*	*	
4:00	*	*	*	*	*	*	*	*	*	*	*	*	*	*	
5:00	*	*	*	*	*	*	*	*	*	*	*	*	*	*	
6:00	*	*	*	*	*	*	*	*	*	*	*	*	*	*	
7:00	*	*	*	*	*	*	*	*	*	*	*	*	*	*	
8:00	*	*	*	*	*	*	*	*	*	*	*	*	*	*	
9:00	*	*	*	*	*	*	*	*	*	*	*	*	*	*	
10:00	*	*	*	*	*	*	*	*	*	*	*	*	*	*	
11:00	*	*	*	*	*	*	*	*	*	*	*	*	*	*	
Total	0	0	0	0	0	0	4	13	16	15	10	1	2	0	
Stats		Percentile	15th	50th	85th	95th									
		Speed	23	27	31	33									
		Mean Speed (Average)	28.0												
		10 MPH Pace Speed	24-33												
		Number in Pace	7603												
		Percent in Pace	81.0%												
		Number > 45 MPH	0												
		Percent > 45 MPH	0.0%												
Grand Total	0	0	3	19	35	98	261	1024	2619	3032	1644	519	119	18	718



# City of Portsmouth, New Hampshire

## *Subdivision Application Checklist*

This subdivision application checklist is a tool designed to assist the applicant in the planning process and for preparing the application for Planning Board review. A pre-application conference with a member of the planning department is strongly encouraged as additional project information may be required depending on the size and scope. The applicant is cautioned that this checklist is only a guide and is not intended to be a complete list of all subdivision review requirements. Please refer to the Subdivision review regulations for full details.

**Applicant Responsibilities (Section III.C):** Applicable fees are due upon application submittal along with required number of copies of the Preliminary or final plat and supporting documents and studies. Please consult with Planning staff for submittal requirements.

Owner: The Frances E. Mouflouze Revoc. Trust of 2015 Date Submitted: 9-16-24

Applicant: Green and Company

Phone Number: 603-501-8455 E-mail: jenna@greenandcompany.com

Site Address 1: 550 Sagamore Avenue Map: 222 Lot: 11

Site Address 2: \_\_\_\_\_ Map: \_\_\_\_\_ Lot: 11

Application Requirements			
<input checked="" type="checkbox"/>	Required Items for Submittal	Item Location (e.g. Page or Plan Sheet/Note #)	Waiver Requested
<input checked="" type="checkbox"/>	Completed Application form. <b>(III.C.2-3)</b>	completed on line	N/A
<input checked="" type="checkbox"/>	All application documents, plans, supporting documentation and other materials provided in digital Portable Document Format (PDF) on compact disc, DVD or flash drive. <b>(III.C.4)</b>	submitted on line	N/A

Requirements for Preliminary/Final Plat			
<input checked="" type="checkbox"/>	Required Items for Submittal	Item Location (e.g. Page/line or Plan Sheet/Note #)	Required for Preliminary / Final Plat
<input checked="" type="checkbox"/>	Name and address of record owner, any option holders, descriptive name of subdivision, engineer and/or surveyor or name of person who prepared the plat. <b>(Section IV.1/V.1)</b>	cover sheet	<input checked="" type="checkbox"/> Preliminary Plat <input checked="" type="checkbox"/> Final Plat

Requirements for Preliminary/Final Plat				
<input checked="" type="checkbox"/>	Required Items for Submittal	Item Location (e.g. Page/line or Plan Sheet/Note #)	Required for Preliminary / Final Plat	Waiver Requested
<input checked="" type="checkbox"/>	<p><b>Preliminary Plat</b> Names and addresses of all adjoining property owners. <b>(Section IV.2)</b></p> <p><b>Final Plat</b> Names and addresses of all abutting property owners, locations of buildings within one hundred (100) feet of the parcel, and any new house numbers within the subdivision. <b>(Section V.2)</b></p>	Subdivision Plan	<input checked="" type="checkbox"/> Preliminary Plat <input checked="" type="checkbox"/> Final Plat	N/A
<input checked="" type="checkbox"/>	North point, date, and bar scale. <b>(Section IV.3/V3)</b>	Required on all Plan Sheets	<input checked="" type="checkbox"/> Preliminary Plat <input checked="" type="checkbox"/> Final Plat	N/A
<input checked="" type="checkbox"/>	Zoning classification and minimum yard dimensions required. <b>(Section IV.4/V.4)</b>	Subdivision Plan	<input checked="" type="checkbox"/> Preliminary Plat <input checked="" type="checkbox"/> Final Plat	N/A
<input type="checkbox"/>	<p><b>Preliminary Plat</b> Scale (not to be smaller than one hundred (100) feet = 1 inch) and location map (at a scale of 1" = 1000'). <b>(Section IV.5)</b></p> <p><b>Final Plat</b> Scale (not to be smaller than 1"=100'), Location map (at a scale of 1"=1,000') showing the property being subdivided and its relation to the surrounding area within a radius of 2,000 feet. Said location map shall delineate all streets and other major physical features that my either affect or be affected by the proposed development. <b>(Section V.5)</b></p>	Subdivision Plan	<input checked="" type="checkbox"/> Preliminary Plat <input checked="" type="checkbox"/> Final Plat	N/A
<input checked="" type="checkbox"/>	Location and approximate dimensions of all existing and proposed property lines including the entire area proposed to be subdivided, the areas of proposed lots, and any adjacent parcels in the same ownership. <b>(Section IV.6)</b>	Subdivision Plan	<input checked="" type="checkbox"/> Preliminary Plat <input checked="" type="checkbox"/> Final Plat	
<input checked="" type="checkbox"/>	Dimensions and areas of all lots and any and all property to be dedicated or reserved for schools, parks, playgrounds, or other public purpose. Dimensions shall include radii and length of all arcs and calculated bearing for all straight lines. <b>(Section V.6/ IV.7)</b>	Subdivision Plan	<input checked="" type="checkbox"/> Preliminary Plat <input checked="" type="checkbox"/> Final Plat	N/A
<input checked="" type="checkbox"/>	Location, names, and present widths of all adjacent streets, with a designation as to whether public or private and approximate location of existing utilities to be used. Curbs and sidewalks shall be shown. <b>(Section IV.8/V.7)</b>	Subdivision Plan	<input checked="" type="checkbox"/> Preliminary Plat <input checked="" type="checkbox"/> Final Plat	

Requirements for Preliminary/Final Plat				
<input checked="" type="checkbox"/>	Required Items for Submittal	Item Location (e.g. Page/line or Plan Sheet/Note #)	Required for Preliminary / Final Plat	Waiver Requested
<input checked="" type="checkbox"/>	Location of significant physical features, including bodies of water, watercourses, wetlands, railroads, important vegetation, stone walls and soils types that may influence the design of the subdivision. <b>(Section IV.9/V.8)</b>	Existing conditions survey, watershed plans	<input checked="" type="checkbox"/> Preliminary Plat <input checked="" type="checkbox"/> Final Plat	
<input checked="" type="checkbox"/>	<b>Preliminary Plat</b> Proposed locations, widths and other dimensions of all new streets and utilities, including water mains, storm and sanitary sewer mains, catch basins and culverts, street lights, fire hydrants, sewerage pump stations, etc. <b>(Section IV.10)</b> <b>Final Plat</b> Proposed locations and profiles of all proposed streets and utilities, including water mains, storm and sanitary sewer mains, catchbasins and culverts, together with typical cross sections. Profiles shall be drawn to a horizontal scale of 1"=50' and a vertical scale of 1"=5', showing existing centerline grade, existing left and right sideline grades, and proposed centerline grade. <b>(Section V.9)</b>	Site Plan, Utilities Plan, Grading Plan, Plan and Profile	<input checked="" type="checkbox"/> Preliminary Plat <input checked="" type="checkbox"/> Final Plat	
<input checked="" type="checkbox"/>	When required by the Board, the plat shall be accompanied by profiles of proposed street grades, including extensions for a reasonable distance beyond the subject land; also grades and sizes of proposed utilities. <b>(Section IV.10)</b>	Grading Plan, Plan and Profile	<input checked="" type="checkbox"/> Preliminary Plat <input checked="" type="checkbox"/> Final Plat	
<input checked="" type="checkbox"/>	Base flood elevation (BFE) for subdivisions involving greater than five (5) acres or fifty (50) lots. <b>(Section IV.11)</b>	NA	<input checked="" type="checkbox"/> Preliminary Plat <input checked="" type="checkbox"/> Final Plat	
<input checked="" type="checkbox"/>	For subdivisions of five (5) lots or more, or at the discretion of the Board otherwise, the preliminary plat shall show contours at intervals no greater than two (2) feet. Contours shall be shown in dotted lines for existing natural surface and in solid lines for proposed final grade, together with the final grade elevations shown in figures at all lot corners. If existing grades are not to be changed, then the contours in these areas shall be solid lines. <b>(Section IV.12/ V.12)</b>	Existing Conditions Survey, Grading Plan	<input checked="" type="checkbox"/> Preliminary Plat <input checked="" type="checkbox"/> Final Plat	

Requirements for Preliminary/Final Plat				
<input checked="" type="checkbox"/>	Required Items for Submittal	Item Location (e.g. Page/line or Plan Sheet/Note #)	Required for Preliminary / Final Plat	Waiver Requested
<input checked="" type="checkbox"/>	Dates and permit numbers of all necessary permits from governmental agencies from which approval is required by Federal or State law. <b>(Section V.10)</b>	Cover Sheet	<input type="checkbox"/> Preliminary Plat <input checked="" type="checkbox"/> Final Plat	
<input checked="" type="checkbox"/>	For subdivisions involving greater than five (5) acres or fifty (50) lots, the final plat shall show hazard zones and shall include elevation data for flood hazard zones. <b>(Section V.11)</b>	NA - noted on Existing Conditions Survey Plan	<input type="checkbox"/> Preliminary Plat <input checked="" type="checkbox"/> Final Plat	
<input checked="" type="checkbox"/>	Location of all permanent monuments. <b>(Section V.12)</b>	Subdivision Plan	<input type="checkbox"/> Preliminary Plat <input checked="" type="checkbox"/> Final Plat	

**General Requirements<sup>1</sup>**

<input checked="" type="checkbox"/>	Required Items for Submittal	Item Location (e.g. Page/line or Plan Sheet/Note #)	Waiver Requested
<input checked="" type="checkbox"/>	<b>1. Basic Requirements: (VI.1)</b>	Subdivision Plan Existing Conditions Survey Grading Plan	
<input checked="" type="checkbox"/>	a. Conformity to Official Plan or Map		
<input checked="" type="checkbox"/>	b. Hazards		
<input checked="" type="checkbox"/>	c. Relation to Topography		
<input type="checkbox"/>	d. Planned Unit Development		
<input checked="" type="checkbox"/>	<b>2. Lots: (VI.2)</b>	Subdivision Plan Subdivision Plan NA	
<input checked="" type="checkbox"/>	a. Lot Arrangement		
<input checked="" type="checkbox"/>	b. Lot sizes		
<input checked="" type="checkbox"/>	c. Commercial and Industrial Lots		
<input checked="" type="checkbox"/>	<b>3. Streets: (VI.3)</b>	Plan and Profile Plan and Profile Plan and Profile NA Plan and Profile NA Plan and Profile NA Plan and Profile NA Plan and Profile Plan and Profile Plan and Profile Site Plan Site Plan NA NA Plan and Profile Site Plan	
<input checked="" type="checkbox"/>	a. Relation to adjoining Street System		
<input checked="" type="checkbox"/>	b. Street Rights-of-Way		
<input checked="" type="checkbox"/>	c. Access		
<input checked="" type="checkbox"/>	d. Parallel Service Roads		
<input checked="" type="checkbox"/>	e. Street Intersection Angles		
<input checked="" type="checkbox"/>	f. Merging Streets		
<input checked="" type="checkbox"/>	g. Street Deflections and Vertical Alignment		
<input checked="" type="checkbox"/>	h. Marginal Access Streets		
<input checked="" type="checkbox"/>	i. Cul-de-Sacs		
<input checked="" type="checkbox"/>	j. Rounding Street Corners		
<input checked="" type="checkbox"/>	k. Street Name Signs		
<input checked="" type="checkbox"/>	l. Street Names		
<input checked="" type="checkbox"/>	m. Block Lengths		
<input checked="" type="checkbox"/>	n. Block Widths		
<input checked="" type="checkbox"/>	o. Grade of Streets		
<input checked="" type="checkbox"/>	p. Grass Strips		
<input checked="" type="checkbox"/>	<b>4. Curbing: (VI.4)</b>	Site Plan	
<input checked="" type="checkbox"/>	<b>5. Driveways: (VI.5)</b>	Site Plan	
<input checked="" type="checkbox"/>	<b>6. Drainage Improvements: (VI.6)</b>	Grading Plan	
<input checked="" type="checkbox"/>	<b>7. Municipal Water Service: (VI.7)</b>	Utilities Plan	
<input checked="" type="checkbox"/>	<b>8. Municipal Sewer Service: (VI.8)</b>	Utilities Plan	
<input checked="" type="checkbox"/>	<b>9. Installation of Utilities: (VI.9)</b>	Utilities Plan and notes, Detail sheets	
<input checked="" type="checkbox"/>	a. All Districts		
<input checked="" type="checkbox"/>	b. Indicator Tape		
<input checked="" type="checkbox"/>	<b>10. On-Site Water Supply: (VI.10)</b>	NA	
<input checked="" type="checkbox"/>	<b>11. On-Site Sewage Disposal Systems: (VI.11)</b>	NA	
<input checked="" type="checkbox"/>	<b>12. Open Space: (VI.12)</b>	Grading Plan NA NA Landscape Plan	
<input type="checkbox"/>	a. Natural Features		
<input type="checkbox"/>	b. Buffer Strips		
<input type="checkbox"/>	c. Parks		
<input type="checkbox"/>	d. Tree Planting		
<input checked="" type="checkbox"/>	<b>13. Flood Hazard Areas: (VI.13)</b>	NOT in a flood hazard zone	
<input type="checkbox"/>	a. Permits		
<input type="checkbox"/>	b. Minimization of Flood Damage		
<input type="checkbox"/>	c. Elevation and Flood-Proofing Records		
<input type="checkbox"/>	d. Alteration of Watercourses		
<input type="checkbox"/>	<b>14. Erosion and Sedimentation Control (VI.14)</b>		

<input checked="" type="checkbox"/>	Required Items for Submittal	Item Location (e.g. Page/line or Plan Sheet/Note #)	Waiver Requested
<input checked="" type="checkbox"/>	<b>15. Easements (VI.15)</b> a. Utilities b. Drainage	utilities plan - water line note Homeowners association	
<input checked="" type="checkbox"/>	<b>16. Monuments: (VI.16)</b>	Subdivision Plan	
<input checked="" type="checkbox"/>	<b>17. Benchmarks: (VI.17)</b>	Existing Conditions Survey	
<input checked="" type="checkbox"/>	<b>18. House Numbers (VI.18)</b>	to be provided	

Design Standards			
	Required Items for Submittal	Indicate compliance and/or provide explanation as to alternative design	Waiver Requested
<input checked="" type="checkbox"/>	<b>1. Streets have been designed according to the design standards required under Section (VII.1).</b> a. Clearing b. Excavation c. Rough Grade and Preparation of Sub-Grade d. Base Course e. Street Paving f. Side Slopes g. Approval Specifications h. Curbing i. Sidewalks j. Inspection and Methods	Plans and details along with notes support compliance with the regulations	
<input checked="" type="checkbox"/>	<b>2. Storm water Sewers and Other Drainage Appurtenances have been designed according to the design standards required under Section (VII.2).</b> a. Design b. Standards of Construction	Drainage Study provided in submission package. Construction notes and details require	
<input checked="" type="checkbox"/>	<b>3. Sanitary Sewers have been designed according to the design standards required under Section (VII.3).</b> a. Design b. Lift Stations c. Materials d. Construction Standards	Design criteria is included on the utilities plan. lift station not required. materials and construction standards shown on the	
<input checked="" type="checkbox"/>	<b>4. Water Mains and Fire Hydrants have been designed according to the design standards required under Section (VII.4).</b> a. Connections to Lots b. Design and Construction c. Materials d. Notification Prior to Construction	Utilities Plan and site work detail sheets	

Applicant's/Representative's Signature: Eric D. Weinrieb PE Date: 9-16-24

<sup>1</sup> See City of Portsmouth, NH Subdivision Rules and Regulations for details.  
Subdivision Application Checklist/January 2018





# City of Portsmouth, New Hampshire

## Site Plan Application Checklist

This site plan application checklist is a tool designed to assist the applicant in the planning process and for preparing the application for Planning Board review. The checklist is required to be completed and uploaded to the Site Plan application in the City's online permitting system. A pre-application conference with a member of the planning department is strongly encouraged as additional project information may be required depending on the size and scope. The applicant is cautioned that this checklist is only a guide and is not intended to be a complete list of all site plan review requirements. Please refer to the Site Plan review regulations for full details.

**Applicant Responsibilities (Section 2.5.2):** Applicable fees are due upon application submittal along with required attachments. The application shall be complete as submitted and provide adequate information for evaluation of the proposed site development. Waiver requests must be submitted in writing with appropriate justification.

Name of Applicant: The Frances E. Mouflouze Revoc Trust of 2015 Date Submitted: 9-16-24

Application # (in City's online permitting): Green and Company

Site Address: 603-501-8455 Map: 222 Lot: 11

Application Requirements			
<input checked="" type="checkbox"/>	Required Items for Submittal	Item Location (e.g. Page or Plan Sheet/Note #)	Waiver Requested
<input checked="" type="checkbox"/>	Complete <a href="#">application</a> form submitted via the City's web-based permitting program (2.5.2.1(2.5.2.3A))	Completed on line	N/A
<input checked="" type="checkbox"/>	All application documents, plans, supporting documentation and other materials uploaded to the application form in viewpoint in digital Portable Document Format (PDF). One hard copy of all plans and materials shall be submitted to the Planning Department by the published deadline. (2.5.2.8)	Submitted on line with one hard copy	N/A

Site Plan Review Application Required Information			
<input checked="" type="checkbox"/>	Required Items for Submittal	Item Location (e.g. Page/line or Plan Sheet/Note #)	Waiver Requested
<input checked="" type="checkbox"/>	Statement that lists and describes "green" building components and systems. (2.5.3.1B)	Application package	
<input checked="" type="checkbox"/>	Existing and proposed gross floor area and dimensions of all buildings and statement of uses and floor area for each floor. (2.5.3.1C)	to be determined	N/A
<input checked="" type="checkbox"/>	Tax map and lot number, and current zoning of all parcels under Site Plan Review. (2.5.3.1D)	Site plans and cover sheet	N/A

**Site Plan Review Application Required Information**

<input checked="" type="checkbox"/>	<b>Required Items for Submittal</b>	<b>Item Location (e.g. Page/line or Plan Sheet/Note #)</b>	<b>Waiver Requested</b>
<input checked="" type="checkbox"/>	Owner's name, address, telephone number, and signature. Name, address, and telephone number of applicant if different from owner. <b>(2.5.3.1E)</b>	Cover sheet, application materials	N/A
<input checked="" type="checkbox"/>	Names and addresses (including Tax Map and Lot number and zoning districts) of all direct abutting property owners (including properties located across abutting streets) and holders of existing conservation, preservation or agricultural preservation restrictions affecting the subject property. <b>(2.5.3.1F)</b>	Existing conditions survey	N/A
<input checked="" type="checkbox"/>	Names, addresses and telephone numbers of all professionals involved in the site plan design. <b>(2.5.3.1G)</b>	Cover sheet	N/A
<input checked="" type="checkbox"/>	List of reference plans. <b>(2.5.3.1H)</b>	Existing conditions survey	N/A
<input checked="" type="checkbox"/>	List of names and contact information of all public or private utilities servicing the site. <b>(2.5.3.1I)</b>	utilities plan	N/A

**Site Plan Specifications**

<input checked="" type="checkbox"/>	<b>Required Items for Submittal</b>	<b>Item Location (e.g. Page/line or Plan Sheet/Note #)</b>	<b>Waiver Requested</b>
<input checked="" type="checkbox"/>	Full size plans shall not be larger than 22 inches by 34 inches with match lines as required, unless approved by the Planning Director.. <b>(2.5.4.1A)</b>	Required on all plan sheets	N/A
<input checked="" type="checkbox"/>	Scale: Not less than 1 inch = 60 feet and a graphic bar scale shall be included on all plans. <b>(2.5.4.1B)</b>	Required on all plan sheets	N/A
<input checked="" type="checkbox"/>	GIS data should be referenced to the coordinate system New Hampshire State Plane, NAD83 (1996), with units in feet. <b>(2.5.4.1C)</b>	Existing conditions survey	N/A
<input checked="" type="checkbox"/>	Plans shall be drawn to scale and stamped by a NH licensed civil engineer. <b>(2.5.4.1D)</b>	Required on all plan sheets	N/A
<input checked="" type="checkbox"/>	Wetlands shall be delineated by a NH certified wetlands scientist and so stamped. <b>(2.5.4.1E)</b>	Existing conditions survey	N/A
<input checked="" type="checkbox"/>	Title (name of development project), north point, scale, legend. <b>(2.5.4.2A)</b>	Existing conditions survey	N/A
<input checked="" type="checkbox"/>	Date plans first submitted, date and explanation of revisions. <b>(2.5.4.2B)</b>	All sheets in title block	N/A
<input checked="" type="checkbox"/>	Individual plan sheet title that clearly describes the information that is displayed. <b>(2.5.4.2C)</b>	Required on all plan sheets	N/A
<input checked="" type="checkbox"/>	Source and date of data displayed on the plan. <b>(2.5.4.2D)</b>	Existing conditions survey	N/A

**Site Plan Specifications – Required Exhibits and Data**

<input checked="" type="checkbox"/>	Required Items for Submittal	Item Location (e.g. Page/line or Plan Sheet/Note #)	Waiver Requested
<input checked="" type="checkbox"/>	<p><b>1. Existing Conditions: (2.5.4.3A)</b></p> <ul style="list-style-type: none"> <li>• Surveyed plan of site showing existing natural and built features;</li> <li>• Existing building footprints and gross floor area;</li> <li>• Existing parking areas and number of parking spaces provided;</li> <li>• Zoning district boundaries;</li> <li>• Existing, required, and proposed dimensional zoning requirements including building and open space coverage, yards and/or setbacks, and dwelling units per acre;</li> <li>• Existing impervious and disturbed areas;</li> <li>• Limits and type of existing vegetation;</li> <li>• Wetland delineation, wetland function and value assessment (including vernal pools);</li> <li>• SFHA, 100-year flood elevation line and BFE data, as required.</li> </ul>	Survey plan and notes	
<input checked="" type="checkbox"/>	<p><b>2. Buildings and Structures: (2.5.4.3B)</b></p> <ul style="list-style-type: none"> <li>• Plan view: Use, size, dimensions, footings, overhangs, 1st fl. elevation;</li> <li>• Elevations: Height, massing, placement, materials, lighting, façade treatments;</li> <li>• Total Floor Area;</li> <li>• Number of Usable Floors;</li> <li>• Gross floor area by floor and use.</li> </ul>	Site Plan elevations not provided	
<input checked="" type="checkbox"/>	<p><b>3. Access and Circulation: (2.5.4.3C)</b></p> <ul style="list-style-type: none"> <li>• Location/width of access ways within site;</li> <li>• Location of curbing, right of ways, edge of pavement and sidewalks;</li> <li>• Location, type, size and design of traffic signing (pavement markings);</li> <li>• Names/layout of existing abutting streets;</li> <li>• Driveway curb cuts for abutting prop. and public roads;</li> <li>• If subdivision; Names of all roads, right of way lines and easements noted;</li> <li>• AASHTO truck turning templates, description of minimum vehicle allowed being a WB-50 (unless otherwise approved by TAC).</li> </ul>	Site plan	
<input checked="" type="checkbox"/>	<p><b>4. Parking and Loading: (2.5.4.3D)</b></p> <ul style="list-style-type: none"> <li>• Location of off street parking/loading areas, landscaped areas/buffers;</li> <li>• Parking Calculations (# required and the # provided).</li> </ul>	Site plan, landscape plan	
<input checked="" type="checkbox"/>	<p><b>5. Water Infrastructure: (2.5.4.3E)</b></p> <ul style="list-style-type: none"> <li>• Size, type and location of water mains, shut-offs, hydrants &amp; Engineering data;</li> <li>• Location of wells and monitoring wells (include protective radii).</li> </ul>	Utilities plan	
<input checked="" type="checkbox"/>	<p><b>6. Sewer Infrastructure: (2.5.4.3F)</b></p> <ul style="list-style-type: none"> <li>• Size, type and location of sanitary sewage facilities &amp; Engineering data, including any onsite temporary facilities during construction period.</li> </ul>	Utilites Plan	

<input checked="" type="checkbox"/>	<b>7. Utilities: (2.5.4.3G)</b> <ul style="list-style-type: none"> <li>The size, type and location of all above &amp; below ground utilities;</li> <li>Size type and location of generator pads, transformers and other fixtures.</li> </ul>	Utilities Plan	
<input checked="" type="checkbox"/>	<b>8. Solid Waste Facilities: (2.5.4.3H)</b> <ul style="list-style-type: none"> <li>The size, type and location of solid waste facilities.</li> </ul>	Plan note, site plan	
<input checked="" type="checkbox"/>	<b>9. Storm water Management: (2.5.4.3I)</b> <ul style="list-style-type: none"> <li>The location, elevation and layout of all storm-water drainage.</li> <li>The location of onsite snow storage areas and/or proposed off-site snow removal provisions.</li> <li>Location and containment measures for any salt storage facilities</li> <li>Location of proposed temporary and permanent material storage locations and distance from wetlands, water bodies, and stormwater structures.</li> </ul>	Grading and Erosion Control plan	
<input checked="" type="checkbox"/>	<b>10. Outdoor Lighting: (2.5.4.3J)</b> <ul style="list-style-type: none"> <li>Type and placement of all lighting (exterior of building, parking lot and any other areas of the site) and photometric plan.</li> </ul>	None provided	
<input checked="" type="checkbox"/>	<b>11. Indicate where dark sky friendly lighting measures have been implemented. (10.1)</b>	no lighting proposed	
<input checked="" type="checkbox"/>	<b>12. Landscaping: (2.5.4.3K)</b> <ul style="list-style-type: none"> <li>Identify all undisturbed area, existing vegetation and that which is to be retained;</li> <li>Location of any irrigation system and water source.</li> </ul>	Landscape plan	
<input checked="" type="checkbox"/>	<b>13. Contours and Elevation: (2.5.4.3L)</b> <ul style="list-style-type: none"> <li>Existing/Proposed contours (2 foot minimum) and finished grade elevations.</li> </ul>	Grading and Erosion Control Plan	
<input checked="" type="checkbox"/>	<b>14. Open Space: (2.5.4.3M)</b> <ul style="list-style-type: none"> <li>Type, extent and location of all existing/proposed open space.</li> </ul>	Site Plan	
<input checked="" type="checkbox"/>	<b>15. All easements, deed restrictions and non-public rights of ways. (2.5.4.3N)</b>	Subdivision Plan	
<input checked="" type="checkbox"/>	<b>16. Character/Civic District (All following information shall be included): (2.5.4.3P)</b> <ul style="list-style-type: none"> <li>Applicable Building Height (10.5A21.20 &amp; 10.5A43.30);</li> <li>Applicable Special Requirements (10.5A21.30);</li> <li>Proposed building form/type (10.5A43);</li> <li>Proposed community space (10.5A46).</li> </ul>	NA	
<input checked="" type="checkbox"/>	<b>17. Special Flood Hazard Areas (2.5.4.3Q)</b> <ul style="list-style-type: none"> <li>The proposed development is consistent with the need to minimize flood damage;</li> <li>All public utilities and facilities are located and construction to minimize or eliminate flood damage;</li> <li>Adequate drainage is provided so as to reduce exposure to flood hazards.</li> </ul>	NA	

**Other Required Information**

<input checked="" type="checkbox"/>	<b>Required Items for Submittal</b>	<b>Item Location (e.g. Page/line or Plan Sheet/Note #)</b>	<b>Waiver Requested</b>
<input type="checkbox"/>	Traffic Impact Study or Trip Generation Report, as required. <b>(3.2.1-2)</b>	In waiver request	
<input checked="" type="checkbox"/>	Indicate where Low Impact Development Design practices have been incorporated. <b>(7.1)</b>	See green statement	
<input checked="" type="checkbox"/>	Indicate whether the proposed development is located in a wellhead protection or aquifer protection area. Such determination shall be approved by the Director of the Dept. of Public Works. <b>(7.3.1)</b>	not in a well head protection area or aquifer	
<input checked="" type="checkbox"/>	Stormwater Management and Erosion Control Plan. <b>(7.4)</b>	Grading and Erosion Control Plan	
<input checked="" type="checkbox"/>	Inspection and Maintenance Plan <b>(7.6.5)</b>	With drainage study	

**Final Site Plan Approval Required Information**

<input checked="" type="checkbox"/>	<b>Required Items for Submittal</b>	<b>Item Location (e.g. Page/line or Plan Sheet/Note #)</b>	<b>Waiver Requested</b>
<input checked="" type="checkbox"/>	All local approvals, permits, easements and licenses required, including but not limited to: <ul style="list-style-type: none"> <li>• Waivers;</li> <li>• Driveway permits;</li> <li>• Special exceptions;</li> <li>• Variances granted;</li> <li>• Easements;</li> <li>• Licenses.</li> </ul> <b>(2.5.3.2A)</b>	Cover sheet and subdivision plan	
<input checked="" type="checkbox"/>	Exhibits, data, reports or studies that may have been required as part of the approval process, including but not limited to: <ul style="list-style-type: none"> <li>• Calculations relating to stormwater runoff;</li> <li>• Information on composition and quantity of water demand and wastewater generated;</li> <li>• Information on air, water or land pollutants to be discharged, including standards, quantity, treatment and/or controls;</li> <li>• Estimates of traffic generation and counts pre- and post-construction;</li> <li>• Estimates of noise generation;</li> <li>• A Stormwater Management and Erosion Control Plan;</li> <li>• Endangered species and archaeological / historical studies;</li> <li>• Wetland and water body (coastal and inland) delineations;</li> <li>• Environmental impact studies.</li> </ul> <b>(2.5.3.2B)</b>	included in application package. Residential wastewater generated Traffic counts noted in waiver request noise - residential subdivision - na erosion control plan in plan package, no special studies required Wetland report in application package	
<input checked="" type="checkbox"/>	A document from each of the required private utility service providers indicating approval of the proposed site plan and indicating an ability to provide all required private utilities to the site. <b>(2.5.3.2D)</b>	to be provided	

**Final Site Plan Approval Required Information**

<input checked="" type="checkbox"/>	Required Items for Submittal	Item Location (e.g. Page/line or Plan Sheet/Note #)	Waiver Requested
<input checked="" type="checkbox"/>	A list of any required state and federal permit applications required for the project and the status of same. <b>(2.5.3.2E)</b>	No Federal permits req'd.	
<input checked="" type="checkbox"/>	A note shall be provided on the Site Plan stating: "All conditions on this Plan shall remain in effect in perpetuity pursuant to the requirements of the Site Plan Review Regulations." <b>(2.5.4.2E)</b>	on Site Plan	N/A
<input checked="" type="checkbox"/>	For site plans that involve land designated as "Special Flood Hazard Areas" (SFHA) by the National Flood Insurance Program (NFIP) confirmation that all necessary permits have been received from those governmental agencies from which approval is required by Federal or State law, including Section 404 of the Federal Water Pollution Control Act Amendments of 1972, 33 U.S.C. 1334. <b>(2.5.4.2F)</b>	NA	
<input checked="" type="checkbox"/>	Plan sheets submitted for recording shall include the following notes: <ul style="list-style-type: none"> <li>a. "This Site Plan shall be recorded in the Rockingham County Registry of Deeds."</li> <li>b. "All improvements shown on this Site Plan shall be constructed and maintained in accordance with the Plan by the property owner and all future property owners. No changes shall be made to this Site Plan without the express approval of the Portsmouth Planning Director."</li> </ul> <b>(2.13.3)</b>	NA	N/A

Applicant's Signature: Eric D. Weinrieb PE Date: 9-16-24

**JOSEPH W. NOEL**  
**P.O. BOX 174**  
**SOUTH BERWICK, MAINE 03908**  
**(207) 384-5587**

CERTIFIED SOIL SCIENTIST \* WETLAND SCIENTIST \* LICENSED SITE EVALUATOR

June 15, 2024

Mr. Eric D. Weinrieb, P.E.  
Altus Engineering  
133 Court Street  
Portsmouth, New Hampshire 03801

RE: Wetland Delineation, 550 Sagamore Avenue, Portsmouth, New Hampshire, JWN #24-58

Dear Eric:

On May 10, 2024, an on-site was made to the above-referenced property (per your request). The purpose was to determine if there were any areas on the lot that would classify as a wetland. A residential home is situated near Sagamore Avenue with the eastern side of the lot being wooded with sporadic bedrock outcrops. One small isolated basin, centrally located on the northern property line did qualify as a wetland. Six sequentially numbered pink and black striped flags (labelled EOW1 thru EOW6) were placed along the wetland-upland boundary.

To determine the wetland boundary, the methodologies in the U.S. Army Corps of Engineers document *Corps of Engineers Wetlands Delineation Manual* (1987) along with the required *Regional Supplement to the Corps of Engineers Wetland Delineation Manual: Northcentral and Northeast Region*, (Version 2.0) were used. Wetlands were identified based on soils, vegetation, and hydrology. Except in special cases, all three factors (hydric soils, hydrophytic vegetation, and wetland hydrology) must be present for an area to classify as wetland.

The wetland area was not ponded with surface water on the day of the site visit. There was evidence of occasional surface water (i.e., water marks) along with blackened leaves and orientated pine needles on the soil surface. The lack of surface water eliminated this area, in my opinion, from being a potential vernal pool. There appears to be a limited watershed that contributes run-off to this basin. Also, there is some evidence that the abutting lot has added fill material that may have blocked the natural runoff from this basin to downslope areas. To be a viable vernal pool surface water needs to be present in the early spring and the hydroperiod needs to be long enough for the breeding amphibians to complete the early life cycle to a juvenile age. This spring there were a number of rain events that filled most vernal pools and this basin did not contain water on May 10, 2024.

This basin does classify as a wetland based on: the poorly drained soil conditions (i.e., hydric soils), evidence of soil saturation and occasional ponding (evidence of wetland hydrology), and

while vegetation was limited in the basin, a few red maples (*Acer rubrum*) were observed (i.e., hydrophytic vegetation).

I hope this letter is sufficient for your planning purposes. Please do not hesitate to call with any questions or concerns.

Sincerely,

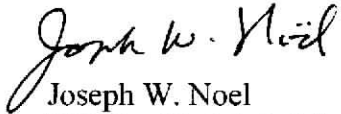

Joseph W. Noel  
NH Certified Soil Scientist #017  
NH Certified Wetland Scientist #086

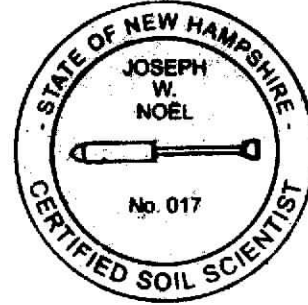



NOT FOR CONSTRUCTION

ISSUED FOR:  
**TAC APPLICATION**

ISSUE DATE:  
**SEPTEMBER 16, 2024**

REVISIONS  
NO. DESCRIPTION BY DATE  
0 INITIAL SUBMISSION EDW 06/04/24

DRAWN BY: \_\_\_\_\_ EDW  
APPROVED BY: \_\_\_\_\_ EDW  
DRAWING FILE: 5591-50-ROW.dwg

SCALE:  
22" x 34" - 1" = 20'  
11" x 17" - 1" = 40'

OWNER:  
**FRANCES E. MOUFLOUZE,  
TED W. ALEX &  
PATRICIA CAMERON, TRUSTEES**  
  
**THE FRANCES E. MOUFLOUZE  
REVOCABLE TRUST OF 2015**  
104 LOCKE RD  
RYE, NH 03870

APPLICANT:  
**GREEN & COMPANY**  
11 LAFAYETTE ROAD  
P.O. BOX 1297  
NORTH HAMPTON, NH 03862

PROJECT:  
**RESIDENTIAL  
DEVELOPMENT**  
  
TAX MAP 222 LOT 11  
550 SAGAMORE AVENUE  
PORTSMOUTH, NH

TITLE: 50' - ROW,  
32' - WIDE ROADWAY  
CONCEPTUAL  
SUBDIVISION PLAN

SHEET NUMBER:  
**1 of 1**

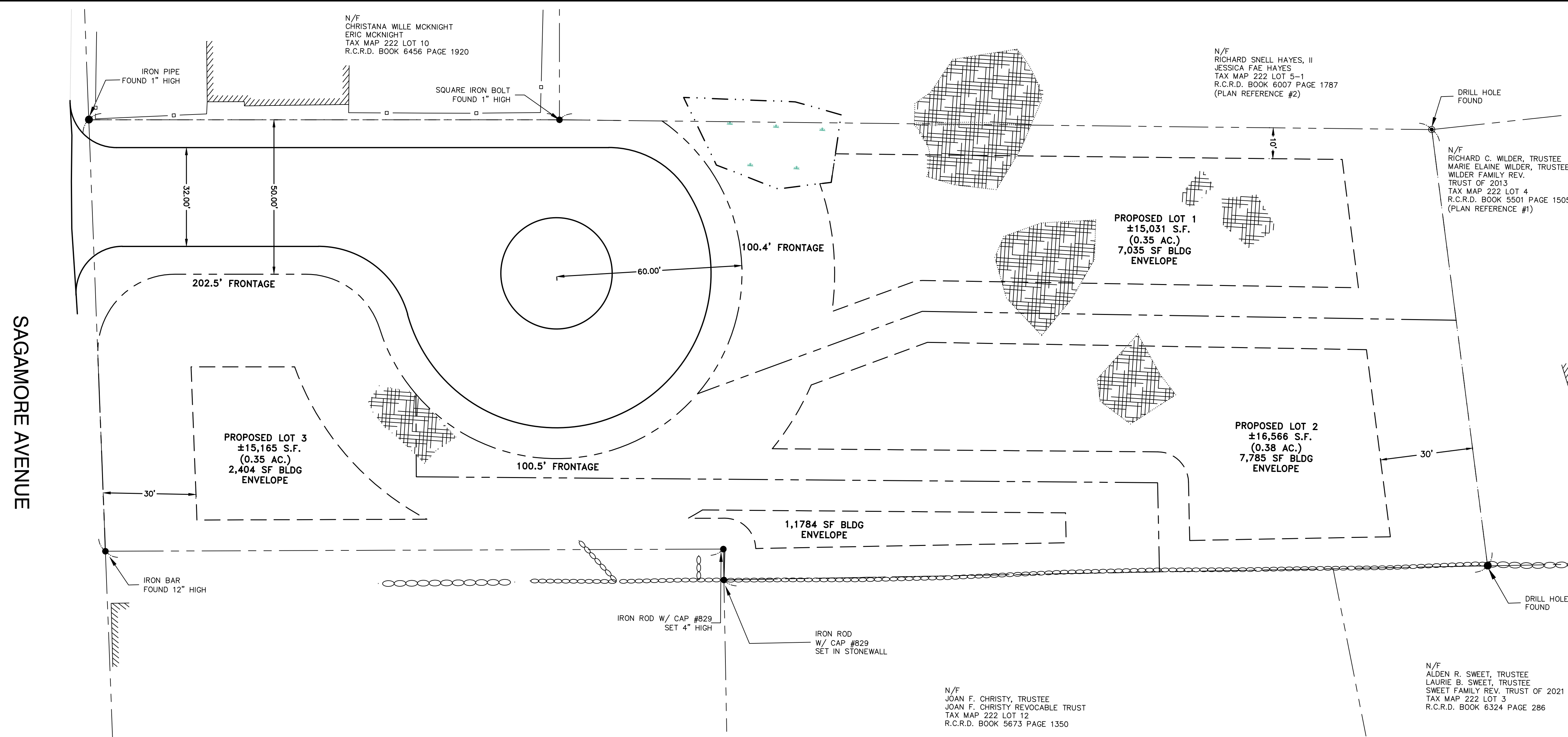

**SUBDIVISION NOTES**

- DESIGN INTENT - THIS PLAN IS INTENDED TO DEPICT A SINGLE-FAMILY RESIDENTIAL SUBDIVISION ON A PRIVATE ROAD.
- ZONE: SRB (SINGLE RESIDENCE B)
- DIMENSIONAL REQUIREMENTS:  

LOT AREA:	15,000 SF
LOT FRONTAGE:	100'
LOT DEPTH:	100'
FRONT YARD:	30'
SIDE YARD:	10'
REAR YARD:	30'
BUILDING COVERAGE:	20%
OPEN SPACE:	40%
WETLAND BUFFER:	NONE - WETLAND LESS THAN 10,000 SF
- PARCEL IS NOT IN A FLOOD HAZARD ZONE AE PER FLOOD INSURANCE RATE MAP (FIRM), ROCKINGHAM COUNTY, NEW HAMPSHIRE, DATED JANUARY 29, 2021.
- WETLANDS WERE DELINEATED BY JOSEPH NOEL, NH CERTIFIED CERTIFIED

**PLAN NOTE:**

THIS CONCEPTUAL PLAN IS PROVIDED TO DEMONSTRATE THAT THE PARCEL CAN BE SUBDIVIDED INTO 3 RESIDENTIAL HOUSE LOTS WITHOUT OBTAINING WAIVERS FOR THE RIGHT-OF-WAY WIDTH AND PAVEMENT WIDTH.  
  
THE APPLICANT WISHES TO DEVELOP THE LAND WITH A PRIVATE RIGHT-OF-WAY AND 20-FOOT WIDE PAVED SURFACE TO REDUCE THE IMPACTS TO THE NEIGHBORHOOD AND TO THE SITE.

**PLAN REFERENCE:**

- "EXISTING CONDITIONS PLAN FOR PROPERTY AT 550 SAGAMORE AVENUE, PORTSMOUTH, NEW HAMPSHIRE", DATED 06/03/24, BY NORTH EASTERLY SURVEYING, INC.

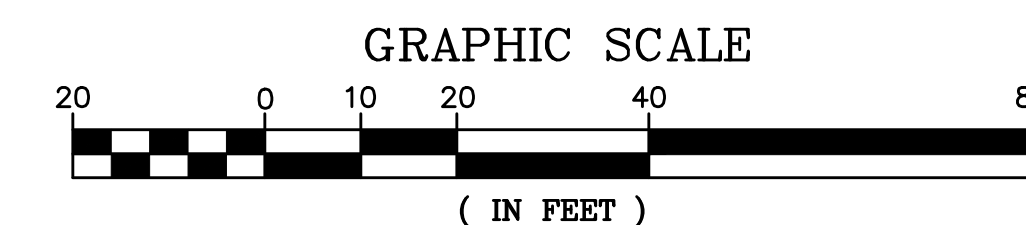

P5591

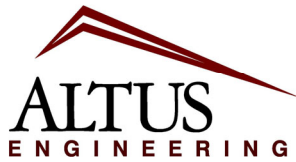

**Civil  
Site Planning  
Environmental  
Engineering**

133 Court Street  
Portsmouth, NH  
03801-4413

## WAIVER REQUESTS

September 16, 2024

**Re: Assessor's Map 222, Lot 11  
550 Sagamore Avenue  
Altus Project No. 5591**

On behalf of Green and Company, Applicant, Altus Engineering, LLC respectfully requests the following waivers from the City of Portsmouth Subdivision Rules and Regulations

### Section VI GENERAL REQUIREMENTS

3. Streets
  - B. Street Rights-of-Way

**Requirement:**

The minimum right-of-way for main thoroughfares shall be as shown on the City's Master Plan or Official Map and shall, when not indicated on such Master Plan or Official Map, be not less than sixty (60) feet; for residential streets, fifty (50) feet. These widths shall be measured from lot line to lot line.

Provided: 40-feet

3. Streets
  - I. Cul-de-Sacs

**Requirement:**

Cul-de-sacs shall be provided at the closed end with a drive-around roadway having a minimum radius for the outside curbs of at least fifty (50) feet, and a street property line radius of sixty (60) feet. The maximum length of a cul-de-sac shall generally be five hundred (500) feet unless otherwise approved by the Board. The Planning Board may require the dedication of an easement of twenty (20) feet in width from the cul-de sac to the next adjoining street to provide for utilities. No water lines serving the street shall be deadended, where feasible.

Provided: Outside curb (pavement edge) 40-feet  
Street property line radius 50-feet

**Requirement:** From Exhibit Residential Street Minimum Standards (32-foot paved surface with a 5-foot wide sidewalk)

## Waiver requests

Provided: 20-feet of pavement along roadway, 22-feet of pavement on cul-de-sac  
Sidewalk not provided

All three waivers are interconnected. The development will service only three single family homes, generating very little traffic, approximately 28 vehicle trips per day on a weekday. A 20-foot-wide roadway can adequately support the expected traffic. The roadway surface was made slightly wider at the cul-de-sac to allow for fire trucks and other emergency vehicles to safely maneuver the site. A fire truck turning template plan is included in the application package that supports the narrower widths proposed. No parking signs along the road are proposed to ensure that vehicles do not block the roadway preventing emergency vehicle access. Each lot will have a 2-car garage and a driveway large enough to park 4 additional vehicles for small gatherings at each home.

Narrower roadways reduce the carbon footprint on the development, reduce stormwater runoff and pollutant loading and reduces the heat island effect on stormwater.

There is a house on the parcel that lacks an adequate area to allow vehicles to turnaround and enter Sagamore Avenue going forward. The additional traffic is minimal and all of the traffic will be able to enter and exit the site safely.

A conceptual subdivision plan is included in the package that depicts a layout that could be constructed that does not require waivers. By granting the waivers, the roadway surface impervious area can be reduced by approximately 3,000 SF. The roadway will be privately owned and maintained. City maintenance vehicles will not need to access the site on a regular basis.

Respectfully submitted by,

**ALTUS ENGINEERING, LLC**



wde/5591.04 waiver.docx



# SHERLOCK

## 387.124.v14 GL

In addition to our Terms and Conditions (the "Terms"), please be aware of the following:

Art Form Architecture, LLC ("Artform") requires that our Drawings be built substantially as designed. Artform will not be obligated by or liable for use of this design with markups as part of any builder agreement. While we attempt to accommodate where possible and reasonable, and where the changes do not denigrate our design, any and all changes to Drawings must be approved in writing by Artform. It is recommended that you have your Drawing updated by Artform prior to attaching any Drawing to any builder agreement. Artform shall not be responsible for the misuse of or unauthorized alterations to any of its Drawings.



Width 48.00 FT

Depth 36.00 FT

Height 33.16 FT

LIVING AREA		BEDROOMS		BATHROOMS	
	3321 FT		6		3
Main	2540 FT	Main	3	Main	3
Future	781 FT	Future	3	Future	0
2 <sup>nd</sup> Unit	0 FT	2 <sup>nd</sup> Unit	0	2 <sup>nd</sup> Unit	0



## SHERLOCK - FRONT ELEVATION

387.124.v14 GL

Some features shown are optional. Your Purchase & Sale Agreement governs, whether items are labeled "optional" in this document or not.



8/23/2022

# Sir Zach

845.125 GL (8/23/2022)

© 2014-2022 Art Form Architecture, Inc., all rights reserved .  
You may not build this design without purchasing a license,  
even if you make changes. This design may have geographic  
restrictions.



603-431-9559

## Dear Builders and Home Buyers,

In addition to our Terms and Conditions (the "Terms", available on ArtformHomePlans.com), please be aware of the following: As defined in the Terms, this is a Design Drawing and may not yet have Construction Drawings (CDs) or the CDs may not reflect design changes. During the conversion of a Design Drawing to Construction Drawings, changes may be necessary including, but not limited to, dimensional changes or changes to the framing and structural supports.

We require that our designs be built substantially as shown in the Drawings. Markups agreed to by Builder and Home Buyer must still be approved by Artform, and may require additional changes, such as structural updates. While we attempt to accommodate requested changes where possible and reasonable, including considerations of design integrity, any and all changes to Drawings must be approved in writing by Artform. It is recommended that you have your Design Drawings updated by Artform prior to attaching any Drawing to any builder agreement. Artform shall not be responsible for the misuse of or unauthorized alterations to any of its Drawings.

- To maintain design integrity, we pay particular attention to features on the front facade, including but not limited to door surrounds, window casings, finished porch column sizes, and roof friezes. While we may allow builders to add their own flare to aesthetic elements, we don't allow our designs to be stripped of critical details. Any such alterations require the express written consent of Artform.
- Increasing or decreasing ceiling heights requires adjustments to window sizes and other exterior elements.

We are not responsible for typographical errors. Home Buyer shall give thoughtful consideration to all drawings and documents provided to them and shall be solely responsible for ensuring that they understand features in the home that are important to them.

8/23/2022

# Sir Zach

845.125 GL (8/23/2022)

© 2014-2022 Art Form Architecture, Inc., all rights reserved .  
You may not build this design without purchasing a license,  
even if you make changes. This design may have geographic  
restrictions.



## Front Elevation

Scale: 1/8" = 1'-0"

8/23/2022

# Sir Zach

845.125 GL (8/23/2022)

© 2014-2022 Art Form Architecture, Inc., all rights reserved .  
You may not build this design without purchasing a license,  
even if you make changes. This design may have geographic  
restrictions.



## Rear Elevation

Scale: 1/8" = 1'-0"





# HARPER WITH SUN

## 872.125 GL

Reverse plan available.

In addition to our Terms and Conditions (the "Terms"), please be aware of the following:

Art Form Architecture, LLC ("Artform") requires that our Drawings be built substantially as designed. Artform will not be obligated by or liable for use of this design with markups as part of any builder agreement. While we attempt to accommodate where possible and reasonable, and where the changes do not denigrate our design, any and all changes to Drawings must be approved in writing by Artform. It is recommended that you have your Drawing updated by Artform prior to attaching any Drawing to any builder agreement. Artform shall not be responsible for the misuse of or unauthorized alterations to any of its Drawings.



©2017-2023 Art Form Architecture, Inc.  
Harper with Sun 872.125 GL

Width 43.00 FT

Depth 56.25 FT

Height 31.33 FT

LIVING AREA		BEDROOMS		BATHROOMS	
	2799 FT		4		2.5
Main	2799 FT	Main	3	Main	2.5
Future	0 FT	Future	1	Future	0
2 <sup>nd</sup> Unit	0 FT	2 <sup>nd</sup> Unit	0	2 <sup>nd</sup> Unit	0



Art Form Architecture, LLC

## HARPER WITH SUN - FRONT ELEVATION

872.125 GL

Some features shown are optional. Your Purchase & Sale Agreement governs, whether items are labeled "optional" in this document or not.





Art Form Architecture, LLC

## HARPER WITH SUN - REAR ELEVATION

872.125 GL

—  
Some features shown are optional. Your Purchase & Sale Agreement governs, whether items are labeled "optional" in this document or not.



# 550 SAGAMORE AVE L1



©2022 Hortycopia, Inc.

OCTOBER GLORY RED MAPLE  
*Acer rubrum* 'October Glory'



©2022 Hortycopia, Inc.

ROBIN HILL SERVICEBERRY  
*Amelanchier x grandiflora* 'Robin Hill'



KAREN AZALEA  
*Azalea* 'Karen'



©2022 Hortycopia, Inc.

GREEN VELVET BOXWOOD  
*Buxus* 'Green Velvet'



©2022 Hortycopia, Inc.

FRANKLINS GEM BOXWOOD  
*Buxus microphylla* 'Franklins Gem'



MOP GOLD THREAD CYPRESS  
*Chamaecyparis pisifera* 'Mop'



NIKKO SLENDER DEUTZIA  
*Deutzia gracilis* 'Nikko'



©2022 Hortycopia, Inc.

NH PURPLE CRANESBILL  
*Geranium sanguineum* 'New Hampshire Purple'



INCREDIBALL HYDRANGEA  
*Hydrangea arborescens* 'Abetwo'



LET'S DANCE BLUE HYDRANGEA  
*Hydrangea macrophylla* 'SMHMTAU'



©2022 Hortycopia, Inc.

PINKY WINKY HYDRANGEA  
*Hydrangea paniculata* 'Pinky Winky™'



SOFT TOUCH HOLLY  
*Ilex crenata* 'Soft Touch'



©2022 Hortycopia, Inc.

SHAMROCK INKBERRY HOLLY  
*Ilex glabra* 'Shamrock'



©2022 Hortycopia, Inc.

LITTLE HENRY SWEETSPIRE  
*Itea virginica* 'Sprich Little Henry'



©2022 Hortycopia, Inc.

WILTONII CREEPING JUNIPER  
*Juniperus horizontalis* 'Wiltonii'



©2022 Hortycopia, Inc.

WICHITA BLUE MT JUNIPER  
*Juniperus scopulorum* 'Wichita Blue'



©2022 Hortycopia, Inc.

EASTERN RED CEDAR  
*Juniperus virginiana*



©2022 Hortycopia, Inc.

TULIP TREE  
*Liriodendron tulipifera*



©2022 Hortycopia, Inc.

MORNING LIGHT MAIDEN GRASS  
*Miscanthus sinensis* 'Morning Light'



©2022 Hortycopia, Inc.

BLUE WONDER CATMINT  
*Nepeta x faassenii* 'Blue Wonder'



©2022 Hortycopia, Inc.

HEAVY METAL SWITCH GRASS  
*Panicum virgatum* 'Heavy Metal'



KARLEY ROSE FOUNTAIN GRASS  
*Pennisetum orientale* 'Karley Rose'

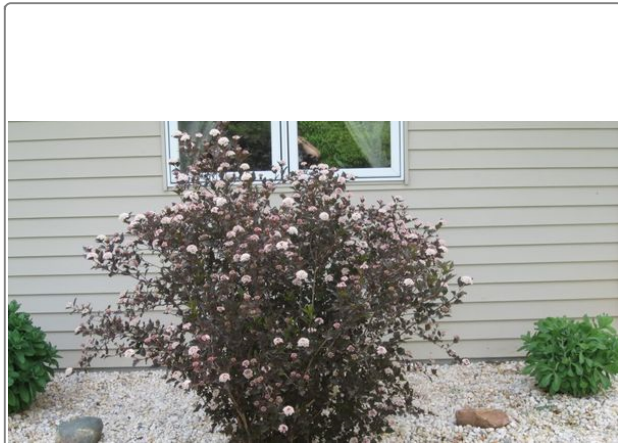

SUMMER WINE NINEBARK  
*Physocarpus opulifolius* 'Seward'



CAVATINE JAPANESE PIERIS  
*Pieris japonica* 'Cavatine'



©2022 Hortycopia, Inc.

EASTERN WHITE PINE  
*Pinus strobus*



©2022 Hortycopia, Inc.

PINK DRIFT ROSE  
*Rosa 'Pink Drift'*



PINK BOMB SEDUM  
*Sedum 'Pink Bomb'*



IVORY SILK TREE LILAC  
*Syringa reticulata 'Ivory Silk'*



©2022 Hortycopia, Inc.

SENSATION COMMON LILAC  
*Syringa vulgaris 'Sensation'*



©2022 Hortycopia, Inc.

DARK AMERICAN ARBORVITAE  
*Thuja occidentalis 'Nigra'*





©2022 Hortycopia, Inc.

CANADIAN HEMLOCK  
*Tsuga canadensis*



©2022 Hortycopia, Inc.

SHASTA DOUBLEFILE VIBURNUM  
*Viburnum plicatum* f. tom. 'Shasta'



WINE & ROSES WEIGELA  
*Weigela florida* 'Alexandra'