

CONTRACT DOCUMENTS AND SPECIFICATIONS

for

**Mechanic Street Pump Station Esthetic Improvements
Bid Proposal #30-13**

John P. Bohenko, City Manager

TABLE OF CONTENTS

INVITATION TO BID	3
INSTRUCTION TO BIDDERS	4
AWARD AND EXECUTION OF CONTRACT	7
PROPOSAL	9
BID SECURITY BOND	12
BIDDER'S QUALIFICATIONS	14
CONTRACT AGREEMENT	16
NOTICE OF INTENT TO AWARD	19
NOTICE TO PROCEED	20
CHANGE ORDER	21
PERFORMANCE BOND	22
LABOR AND MATERIALS PAYMENT BOND	24
MAINTENANCE BOND	26
CONTRACTOR'S AFFIDAVIT	27
CONTRACTOR'S RELEASE	28
GENERAL REQUIREMENTS	29
CONTROL OF WORK	31
INSURANCE REQUIREMENTS	33
TEMPORARY FACILITIES	34
MEASUREMENT AND PAYMENT	35
SHOP DRAWINGS	39
ATTACHMENT A - NH DES WETLANDS PERMIT	40
SPECIFICATIONS	42

City of Portsmouth
Portsmouth, NH
Department of Public Works

Mechanic Street Pump Station Esthetic Improvements

INVITATION TO BID

Sealed bid proposals, **plainly marked, Mechanic Street Pump Station Esthetic Improvements**, Bid Proposal #30-13 **on the outside of the mailing envelope as well as the sealed bid envelope**, addressed to the Finance/Purchasing Department, City Hall, 1 Junkins Avenue, Portsmouth, New Hampshire, 03801, will be accepted until **April 17, 2013 at 2:00 p.m.** at which time all bids will be publicly opened and read aloud. A mandatory pre-bid meeting will be held Tuesday, April 2, 2013 at 10:00 a.m. at the Mechanic Street Pump Station, 113 Mechanic Street, Portsmouth, N.H.

The work shall consist of esthetic improvements to the Mechanic Street Pump Station building, including items such as a steel parapet, fencing, plantings, cobble stone walkway, wood trellis, and lighting.

Completion date will be 60 calendar days from the date of the Notice to Proceed. Liquidated damages shall be assessed at \$500.00 per day.

Contractors must have at least 5 years of successful experience in the field of general contracting. Bidders must determine the quantities of work required and the conditions under which the work will be performed.

Specifications, drawings, and bid proposal forms may be obtained from the City website at <http://www.cityofportsmouth.com/finance/purchasing.htm>. Questions may be directed to Rick Dolce, P.E., Facilities Project Manager at (603) 766-1413. Addenda to this bid document, if any, including written answers to questions, will be posted on the City of Portsmouth website at <http://www.cityofportsmouth.com/finance/purchasing.htm> under the project heading. Addenda and updates will **NOT** be sent directly to vendors.

The City of Portsmouth reserves the right to reject any or all bids, to waive technical or legal deficiencies, to re-bid, and to accept any bid that it may deem to be in the best interest of the City.

Each Bidder shall furnish a bid security in the amount of ten percent (10%) of the bid. The Bid Security may be in the form of a certified check or a bid bond executed by a surety company authorized to do business in the State of New Hampshire, made payable to the City of Portsmouth, N.H.

INSTRUCTIONS TO BIDDERS

BIDDING REQUIREMENTS AND CONDITIONS

1. Special Notice to Bidders

Appended to these instructions is a complete set of bidding and general contract forms. These forms may be detached and executed for the submittal of bids. The plans, specifications, and other documents designated in the proposal form will be considered as part of the proposal, whether attached or not.

The bidders must submit a statement of bidder's qualifications, if requested, subsequent to bid opening but prior to award.

Addenda to this proposal, if any, including written answers to questions, will be posted on the City of Portsmouth website at <http://www.cityofportsmouth.com/finance/purchasing.htm> under the project heading. Addenda and updates will NOT be sent directly to firms. Contractors submitting a bid proposal should check the web site daily for addenda and updates after the release date. Firms should print out, sign and return addenda with the proposal. Failure to do so may result in disqualification.

2. Interpretation of Quantities in Bid Schedules

The quantities appearing in the bid schedule are approximate only and are prepared for the comparison of bids. Payment to the contractor will be made only for actual work performed and accepted in accordance with the contract. Any scheduled item of work to be done and materials to be furnished may be increased, decreased or omitted as hereinafter provided, and no claim for loss, anticipated profits or costs incurred in anticipation of work not ultimately performed will be allowed due to such increase or decrease.

3. Examination of Plans, Specifications and Site Work

The bidder is expected to examine carefully the site of the proposed work, the plans, standard specifications, supplemental specifications, special provisions and contract forms before submitting a proposal. The submission of a bid shall be considered conclusive evidence that the bidder has made such examination and is satisfied as to the conditions to be encountered in performing the work and as to the requirements of the contract. It will be conclusive evidence that the bidder has also investigated and is satisfied with the sources of supply for all materials.

Plans, surveys, measurements, dimensions, calculations, estimates and statements as to the condition under which the work is to be performed are believed to be correct, but the contractors must examine for themselves, as no allowance will be made for any errors or inaccuracies that maybe found therein.

4. Familiarity with Laws

The bidder is assumed to have made himself or herself familiar with all federal and state laws and all local by-laws, ordinances and regulations which in any manner affect those engaged or employed on the work or affect the materials or equipment used in the work or affect the conduct of the work, and the bidder, if awarded the contract, shall be obligated to perform the work in conformity with said laws, by-laws, ordinances and regulations notwithstanding its ignorance thereof. If the bidder shall discover any provision in the plans or specifications which is in conflict with any such law, by-law, ordinance or regulation the bidder shall forthwith report it to the Owner in writing.

5. Preparation of Proposal

a) The bidder shall submit its proposal upon the forms furnished by the Owner. The bidder shall specify a lump sum price in figures, for each pay item for which a quantity is given and shall also show the products of the respective prices and quantities written in figures in the column provided for that purpose. All words and figures shall be in ink or typed. If a unit price or a lump sum bid already entered by the bidder on the proposal form is to be altered it should be crossed out with ink, the new unit price or lump sum bid entered above or below it and initialed by the bidder, also with ink.

b) The bidder's proposal must be signed with ink by the individual, by one or more general partners of a partnership, by one or more members or officers of each firm representing a joint venture; by one or more officers of a corporation, by one or more members (if member-managed) or managers (if manager-managed) of a limited liability company, or by an agent of the contractor legally qualified and acceptable to the owner. If the proposal is made by an individual, his or her name and post office address must be shown, by a partnership the name and post office address of each general and limited partner must be shown; as a joint venture, the name and post office address of each venturer must be shown; by a corporation, the name of the corporation and its business address must be shown, together with the name of the state in which it is incorporated, and the names, titles and business addresses of the president, secretary and treasurer.

6. Nonconforming Proposals

Proposals will be considered nonconforming and may be rejected in the Owner's sole discretion for any of the following reasons:

- If the proposal is on a form other than that furnished by the Owner, or if the form is altered or any portion thereof is detached;
- If there are unauthorized additions, conditional or altered bids, or irregularities of any kind which may tend to make the proposal or any portion thereof incomplete, indefinite or ambiguous as to its meaning;
- If the bidder adds any provisions reserving the right to accept or reject an award, or to enter into a contract pursuant to an award; or
- If the proposal does not contain a lump sum or unit price for each pay item listed except in the case of authorized alternate pay items.

7. Proposal Guaranty

No proposal will be considered unless accompanied by a bid bond, surety, or similar guaranty of the types and in an amount not less than the amount indicated in the Invitation to Bid. All sureties shall be made payable to the "City of Portsmouth". If a bid bond is used by the bidder it shall be:

- In a form satisfactory to the Owner;
- With a surety company licensed, authorized to do business in, and subject to the jurisdiction of the courts of the State of New Hampshire; and
- Conditioned upon the faithful performance by the principal of the agreements contained in the sub-bid or the general bid.

In the event any irregularities are contained in the proposal guaranty, the bidder will have four business days (not counting the day of opening) to correct any irregularities. The corrected guaranty must be received by 4:00 p.m. If irregularities are not corrected to the satisfaction of the Owner, the Owner, in its sole discretion, may rejected the bid.

8. Delivery of Proposals

When sent by mail, the sealed proposal shall be addressed to the Owner at the address and in the care of the official in whose office the bids are to be received. All proposals shall be filed prior to the time and at the place specified in the invitation for bids. Proposals received after the time for opening of the bids will be returned to the bidder, unopened.

9. Withdrawal of Proposals

A bidder will be permitted to withdraw his or her proposal unopened after it has been submitted if the Owner receives a request for withdrawal in writing prior to the time specified for opening the proposals.

10. Public Opening of Proposals

Proposals will be opened and read publicly at the time and place indicated in the invitation for bids. Bidders, their authorized agents, and other interested parties are invited to be present.

11. Disqualification of Bidders

Any or all of the following reasons may be deemed by Owner in its sole discretion as being sufficient for the disqualification of a bidder and the rejection of his proposal:

- More than one proposal for the same work from an individual, firm, or corporation under the same or different name;
- Evidence of collusion among bidders;
- Failure to submit all required information requested in the bid specifications;
- **Contractor lacks sufficient experience in general contracting (5 years);**
- Lack of competency or of adequate machinery, plant or other equipment, as revealed by the statement of bidders qualification or otherwise;
- Uncompleted work which, in the judgment of the owner, might hinder or prevent the prompt completion of additional work if awarded;
- Failure to pay, or satisfactorily settle, all bills due for labor and materials on former contracts;
- Default or unsatisfactory performance on previous contracts; or
- Such disqualification would be in the best interests of the Owner.

12. Material Guaranty and Samples

Before any contract is awarded, the bidder may be required to furnish a complete statement of the origin, composition and manufacture of any or all materials to be used in the construction of the work, and the Owner may, in its sole discretion, reject the bid based on the contents of the statement or as a result of the failure of the bidder to submit the statement.

AWARD AND EXECUTION OF CONTRACT

1. Consideration of Proposals

a) After the proposals are opened and read, they will be compared on the basis of the total price for all sections of work to be charged to perform the work and any such additional considerations as may be identified in the bid documents. The results of such comparisons will be immediately available to the public. In case of a discrepancy between the prices written in words and those written figures, the prices written in words shall govern. In case of a discrepancy between the total shown in the proposal and that obtained by adding the products of the quantities of items and unit bid prices, the latter shall govern.

2. Award of Contract

Within 30 calendar days after the opening of proposals, if a contract is to be awarded, the award will be made to the lowest responsible and qualified bidder whose proposal complies with all the requirements prescribed. The successful bidder will be notified, in writing, mailed to the address on his or her proposal, that his or her bid has been accepted and that the bidder has been awarded the contract.

The award shall not be considered official until such time that a Purchase Order, fully executed contract or an award letter has been issued by the Finance Director. No presumption of award shall be made by the bidder until such documents are in hand. Verbal notification of award is not considered official. Any action by the bidder to assume otherwise is done so at his/her own risk and the City will not be held liable for any expense incurred by a bidder that has not received an official award.

Basis of award will be based on the Base bid, or the Base Bid with any combination of Alternates the City deems to be in its best interest.

Contract award is dependent upon available funds.

3. Reservation of Rights

The Owner reserves the right to reject any or all proposals, to waive technicalities or to advertise for new proposals, if, in the sole discretion of the Owner, the best interest of the City of Portsmouth will be promoted thereby.

The City reserves the right to make inquires regarding the qualifications and reputation of the bidder. By submitting a bid proposal, bidder agrees to hold harmless the Owner and its employees and agents from any and all claims, actions, and damages arising from such investigation. Bidder may be requested to execute releases.

The Owner reserves the right to cancel the award of any contract at any time before the execution of such contract by all parties without any liability of the Owner.

4. Return of Proposal Guaranty

All proposal guaranties, except those of the three lowest bidders, will be returned upon request following the opening and checking of the proposals. The proposal guaranties of the three lowest bidders will be returned within ten days following the award of the contract if requested.

5. Contract Bonds

At the time of the execution of the contract, the successful bidder shall furnish:

- A performance bond in the amount of 100 percent of the contract amount.
- Labor and materials payment bond in the sum equal to 100 percent of the contract amount.

At the time of project completion, the Owner may, in its sole discretion, permit the Contractor to substitute a maintenance bond in lieu of holding retainage for the entire guaranty period. If a bond is furnished it shall meet the following criteria:

- The bond shall be in an amount equal to 20 percent of the contract amount. Such bond shall guarantee the repair of all damage due to faulty materials or workmanship provided or done by the contractor. The guarantee shall remain in effect for a period of one year after the date of final acceptance of the job by the Owner.

Each bond shall be: (1) in a form satisfactory to the Owner; (2) with a surety company licensed and authorized to do business and with a resident agent designated for services of process in the State of New Hampshire; and (3) conditioned upon the faithful performance by the principal of the agreements contained in the original bid. All premiums for the contract bonds are to be paid by the contractor.

6. Execution and Approval of Contract

The successful bidder is required to present all contract bonds, to provide proof of insurance, and to execute the contract within 10 days following receipt of the City's notification of acceptance of the bid. No contract shall be considered as in effect until it has been fully executed by all parties.

7. Failure to Execute Contract

Failure to execute the contract and file acceptable bonds within 10 days after notification of acceptance of bid shall be just cause for the cancellation of the award and the forfeiture of the proposal guarantee which shall become the property of the Owner, not as a penalty, but in liquidation of damages sustained. Award may then be made to the next lowest responsible bidder, or the City may exercise its reserved rights including the rejection of all bids or re-advertisement.

PROPOSAL FORM

Mechanic Street Pump Station Esthetic Improvements

CITY OF PORTSMOUTH, N.H.

To the City of Portsmouth, New Hampshire, herein called the Owner.

The undersigned, as Bidder, herein referred to as singular and masculine declares as follows:

1. All interested in the Bid as Principals are named herein.
2. This bid is not made jointly, or in conjunction, cooperation or collusion with any other person, firm, corporation, or other legal entity;
3. No officer, agent or employee of the Owner is directly or indirectly interested in this Bid.
4. The bidder has carefully examined the sites of the proposed work and fully informed and satisfied himself as to the conditions there existing, the character and requirements of the proposed work, the difficulties attendant upon its execution and the accuracy of all estimated quantities stated in this Bid, and the bidder has carefully read and examined the Drawings (“Mechanic Street Pump Station” by TMS Architects), Agreement, Specifications, and other Contract Documents therein referred to and knows and understands the terms and provisions thereof;
5. The bidder understands that the quantities of work calculated in the Bid or indicated on the Drawings or in the Specifications or other Contract Documents are approximate and are subject to increase or decrease or deletion as deemed necessary by the Portsmouth City Engineer. Any such changes will not result in or be justification for any penalty or increase in contract prices; and agrees that, if the Bid is accepted the bidder will contract with the Owner, as provided in the Contract Documents, this Bid Form being part of said Contract Documents, and that the bidder will supply or perform all labor, services, plant, machinery, apparatus, appliances, tools, supplies and all other activities required by the Contract Documents in the manner and within the time therein set forth, and that the bidder will take in full payment therefor the following item prices;
6. It is the intention of this contract that the items listed above describe completely and thoroughly the entirety of the work as shown on the plans and as described in the specifications. All other items required to accomplish the above items are considered to be subsidiary work, unless shown as a pay item, to wit:

THIS PROJECT SHALL BE BID BY LUMP SUM WITH ALTERNATES:

Total Amount of BASE BID compiled by the Bidder.

In Figures \$ _____

In Words _____ Dollars

Basis of award will be based on the Base bid, or the Base Bid with any combination of Alternates the City deems to be in its best interest.

Contract award is contingent upon available funding.

PROPOSAL FORM (Continued)

ALTERNATES & UNIT PRICES

At the owner’s option, and in accordance with the General Conditions, the following Alternates and Unit Prices shall be used for additions and/or deletions to the Scope of Work, and shall be inclusive of furnishing and installing of material, labor, trucking, overhead, profit, equipment, hoisting, engineering, scaffolding, power hookups, protection, shop drawings, taxes, permits, appliances, delivery and supervision and shall remain in effect until completion of the contract.

The Owner will inform the Contractor which Alternates, if any, will be added to the Base Bid prior to contract execution and bonding.

ALTERNATES:

Bid Alternate #1: **DEDUCT** Cost to Furnish & Install New Stained Wood Fence, including gate and 8ft long removable panel, per Linear Foot (LF)

In Figures \$ _____

In Words _____

UNIT PRICING:

1) Furnish & Install New 2”-3” Caliper Japanese Flowering Cherry (Prunus x yedoensis).

In Figures \$ _____

In Words _____

2) Furnish & Install New Belgian Block Walkway, per Square Foot (SF)

In Figures \$ _____

In Words _____

To Bidder: It is the intention of this contract that the items listed above describe completely and thoroughly the entirety of the work as shown on the plans and as described in the specifications. All other items required to accomplish the above items are considered to be subsidiary work, unless shown as a pay item.

The undersigned agrees that for extra work, if any, performed in accordance with the terms and provisions of the Contract Documents, the bidder will accept compensation as stipulated therein.

DATE

COMPANY

BY: _____
SIGNATURE

TITLE

STREET ADDRESS, CITY, STATE, ZIP CODE, TELEPHONE NUMBER

The Bidder has received and acknowledged Addenda No. _____ through _____.

All Bids are to be submitted on this form and in a sealed envelope, plainly marked on the outside with the Bidder's name and address and the Project name as it appears at the top of the Proposal Form.

BID SECURITY BOND

(This format provided for convenience, actual Bid Bond is acceptable in lieu of, if compatible.)

KNOW ALL MEN BY THESE PRESENTS, that we the undersigned

_____, as Principal, and

_____, as Surety, are hereby

held and firmly bound unto _____

IN THE SUM OF _____

as liquidated damages for payment of which, well and truly to be made we hereby jointly and severally bind ourselves, our heirs, executors, administrators, successors and assigns.

The condition of this obligation is such that whereas the Principal has submitted to the

_____ A CERTAIN Bid attached hereto and hereby made a part hereof to enter into a contract in writing, hereinafter referred to as the "AGREEMENT" and or "CONTRACT", for

NOW THEREFORE,

- (a) If said Bid shall be rejected or withdrawn as provided in the INFORMATION FOR BIDDERS attached hereto or, in the alternative,
- (b) If said Bid shall be accepted and the Principal shall duly execute and deliver the form of AGREEMENT attached hereto and shall furnish the specified bonds for the faithful performance of the AGREEMENT and/or CONTRACT and for the payment for labor and materials furnished for the performance of the AGREEMENT and or CONTRACT,

then this obligation shall be void, otherwise it shall remain in full force and effect; it being expressly understood and agreed that the liability of the Surety for any and all claims hereunder in no event shall exceed the amount of this obligation.

BID SECURITY BOND (continued)

The Surety, for value received, hereby agrees that the obligation of said surety and its bond shall be in no way impaired or affected by any extensions of the time within such BID may be accepted, and said Surety does hereby waive notice of any such extension.

IN WITNESS WHEREOF, the parties hereto have duly executed

this bond on the _____ day of _____, 20__.

(Name of Principal)

(SEAL)

BY _____

(Name of Surety)

BY _____

STATEMENT OF BIDDER'S QUALIFICATIONS

Supply with Bid

All questions must be answered and the data given must be clear and comprehensive. Add separate sheets if necessary

1. Name of Bidder
2. Permanent Main Office Address
3. Form of Entity
4. When Organized
5. Where Organized
6. How many years have you been engaged in the contracting business under your present name; also state names and dates of previous firm names, if any.
7. Contracts on hand; (schedule these, showing gross amount of each contract and the approximate anticipated dates of completion).
8. General character of work performed by your company.
9. Have you failed within the last seven years to complete any work awarded to you?
____(no)____(yes). If so, where and why?
10. Have you defaulted on a contract within the last seven years?
____(no)____(yes). If so, where and why?
11. Have you ever failed to complete a project in the time allotment according to the Contract Documents?
____(no)____(yes). If so, where and why?
12. List the most important contracts recently executed by your company, stating approximate cost for each, and the month and year completed.
13. List your major equipment available for this contract.
14. List your key personnel such as project superintendent and foremen available for this contract.
15. List any subcontractors whom you would expect to use for this project and their scope of work (unless this work is to be done by your own organization).

Subcontractor: _____ Scope of work: _____

Subcontractor: _____ Scope of work: _____

Subcontractor: _____ Scope of work: _____

(The City reserves the right to approve or disapprove subcontractors for this project)

STATEMENT OF BIDDERS QUALIFICATIONS (continued)

16. Contractor must have at least five years prior experience in commercial/municipal roof installation and construction projects. Describe that prior experience, identifying projects/contracts that have been successfully completed within the last five years.

Latest Financial Statements: The City reserves the right to request Bidders' latest Financial Statements. Certified audited statements if available, prepared by an independent certified public accountant, may be requested by Owner. If requested, such statements must be provided within five (5) business days or the bid proposal will be rejected. Certified Audited Statement are preferred. Internal statements may be used only if independent statements were not prepared.

Dated at _____ this _____ day of _____, 20__.

Name of Bidder

BY _____

TITLE _____

State of _____

County of _____

_____ being duly sworn, deposes and

says that the bidder is _____ of _____
(Name of Organization)

and answers to the foregoing questions and all statements contained therein are true and correct.

Sworn to before me this _____ day of _____, 20__.

Notary of Public

My Commission expires _____

CONTRACT AGREEMENT

Mechanic Street Pump Station Esthetic Improvements

THIS AGREEMENT made as of the ___ day of _____ in the year **2013**, by and between the City of Portsmouth, New Hampshire (hereinafter call the Owner) and _____ (hereinafter called the Contractor),

WITNESSETH; that the Owner and Contractor, in consideration of the mutual covenants hereinafter set forth, agree as follows:

ARTICLE I - Work - The Contractor shall perform all work as specified or indicated in the Contract Documents for the completion of the Project. The Contractor shall provide, at his expense, all labor, materials, equipment and incidentals as may be necessary for the expeditious and proper execution of the Project.

ARTICLE II - ENGINEER - The City Engineer shall mean the Director of Public Works, or his authorized representative will act as engineer in connection with completion of the Project in accordance with the Contract Documents.

ARTICLE III - CONTRACT TIME - The work will commence and finish in accordance with the Notice to Proceed and shall be completed within **60** days.

ARTICLE IV - CONTRACT PRICE - Owner shall pay Contractor for performance of the work in accordance with the Contract Documents.

ARTICLE V - PAYMENT - Partial payments will be made in accordance with the Contract Documents. Upon final acceptance of the work and settlement of all claims, Owner shall pay the Contractor the unpaid balance of the Contract Price, subject to additions and deductions provided for in the Contract Documents.

ARTICLE VI - RETAINAGE – To insure the proper performance of this Contract, the Owner shall retain ten percent of the Contract Price as specified in the Contract Documents.

ARTICLE VII - LIQUIDATED DAMAGES - In event the Contractor fails to successfully complete the work within the specified contract time the Owner shall assess the Contractor liquidated damages in the amount of **five hundred dollars (\$500.00)** for each calendar day beyond the specified completion date. Liquidated damages shall be deducted from the Contract Price prior to final payment of the Contractor.

CONTRACT AGREEMENT (continued)

ARTICLE VIII – CONTRACT DOCUMENTS – The Contract Documents which comprise the contract between Owner and Contractor are attached hereto and made a part hereof and consist of the following:

- 8.1 This Agreement
- 8.2 Contractor’s Bid and Bonds
- 8.3 Notice of Award, Notice to Proceed
- 8.4 Instruction to Bidders
- 8.5 General Requirements, Control of Work, Temporary Facilities, Measurement and Payment, Standard Specifications
- 8.6 Insurance Requirements
- 8.7 Specifications
- 8.8 Drawings: “Mechanic Street Pump Station” by TMS Architects
- 8.9 NH Department of Environmental Services Wetlands Permit #2012-02922
- 8.10 Special Provisions
- 8.11 Any modifications, including change orders, duly delivered after execution of this Agreement.

ARTICLE IX – TERMINATION FOR DEFAULT – Should contractor at any time refuse, neglect, or otherwise fail to supply a sufficient number or amount of properly skilled workers, materials, or equipment, or fail in any respect to prosecute the work with promptness and diligence, or fail to perform any of its obligations set forth in the Contract, Owner may, at its election, terminate the employment of Contractor, giving notice to Contractor in writing of such election, and enter on the premises and take possession, for the purpose of completing the work included under this Agreement, of all the materials, tools and appliances belonging to Contractor, and to employ any other persons to finish the work and to provide the materials therefore at the expense of the Contractor.

ARTICLE X – INDEMNIFICATION OF OWNER – Contractor will indemnify Owner against all suits, claims, judgments, awards, loss, cost or expense (including without limitation attorneys’ fees) arising in any way out of the Contractor’s negligent performance of its obligations under this Contract. Contractor will defend all such actions with counsel satisfactory to Owner at its own expense, including attorneys’ fees, and will satisfy any judgment rendered against Owner in such action.

ARTICLE XI – PERMITS – The Contractor will secure at its own expense, all permits and consents required by law as necessary to perform the work and will give all notices and pay all fees and otherwise comply with all applicable City, State, and Federal laws, ordinances, rules and regulations. The owner has previously obtained a New Hampshire Department of Environmental Services Wetlands and Non-Site Specific Permit

ARTICLE XII – INSURANCE – The Contractor shall secure and maintain, until acceptance of the work, insurance with limits not less than those specified in the Contract.

ARTICLE XIII – MISCELLANEOUS –

- A. Neither Owner nor Contractor shall, without the prior written consent of the other, assign, sublet or delegate, in whole or in part, any of its rights or obligations under any of the Contract Documents; and, specifically not assign any monies due, or to become due, without the prior written consent of Owner.
- B. Owner and Contractor each binds himself, his partners, successors, assigns and legal representatives, to the other party hereto in respect to all covenants, agreements and obligations contained in the Contract Documents.
- C. The Contract Documents constitute the entire Agreement between Owner and Contractor and may only be altered amended or repealed by a duly executed written instrument.
- D. The laws of the State of New Hampshire shall govern this Contract without reference to the conflict of law principles thereof.
- E. Venue for any dispute shall be the Rockingham County Superior Court unless the parties otherwise agree.

IN WITNESS WHEREOF, the parties hereunto executed this

AGREEMENT the day and year first above written.

BIDDER:

BY: _____

TITLE: _____

CITY OF PORTSMOUTH, N.H.

BY: _____
John P. Bohenko

TITLE: City Manager

NOTICE OF INTENT TO AWARD

Date:

To:

IN AS MUCH as you were the low responsible bidder for work entitled:

Mechanic Street Pump Station Esthetics Improvements

You are hereby notified that the City intends to award the above referenced project to you.

Immediately take the necessary steps to execute the Contract and to provide required bonds and proof of insurance within ten (10) calendar days from the date of this Notice.

The City reserves the right to revoke this Notice if you fail to take the necessary steps to execute this Contract.

City of Portsmouth
Portsmouth, New Hampshire

Judie Belanger,
Finance Director

NOTICE TO PROCEED

DATE:

Mechanic Street Pump Station Esthetics Improvements

TO:

YOU ARE HEREBY NOTIFIED TO COMMENCE WORK IN ACCORDANCE
WITH THE AGREEMENT DATED, _____
WORK SHALL BE COMPLETED PRIOR TO _____.

CITY OF PORTSMOUTH, N.H.

BY: Steven F. Parkinson, PE

TITLE: Public Works Director

ACCEPTANCE OF NOTICE

RECEIPT OF THE ABOVE NOTICE TO
PROCEED IS HEREBY ACKNOWLEDGED BY

This the _____ day of _____ 20__

By: _____

Title: _____

CHANGE ORDER

Change Order Number:

Date of Issuance:

Owner: CITY OF PORTSMOUTH, N.H

Contractor:

You are directed to make the following changes in the Contract Documents:

Purpose of Change Order:

Attachments:

CHANGE IN CONTRACT PRICE

CHANGE IN CONTRACT TIME

Original Contract Price:
\$

Original Completion Date:

Contract Price prior to this Change Order:
\$

Contract Time prior to this Change Order:
days

Net Increase of this Change Order:
\$

Net Increase of this Change Order:
days

Contract Price with all approved Change Orders:
\$

Contract Time with all approved Change Orders:
days

RECOMMENDED:

APPROVED:

APPROVED:

by _____ by _____ by _____ by _____
PW Director City Finance City Manager Contractor

PERFORMANCE BOND

(This format provided for convenience, actual Performance Bond is acceptable in lieu, if compatible)

Bond Number _____

KNOW ALL MEN BY THESE PRESENTS

that _____ as principal, hereinafter called Contractor, and _____ (Surety Company) a [corporation] organized and existing under the laws of the State of _____ and authorized to do business in the State of New Hampshire as surety, hereinafter called Surety, are held and firmly bound unto the City of Portsmouth, N.H., hereinafter called Owner, in the amount of _____ Dollars (\$ _____), for the payment whereof Contractor and Surety bind themselves, their heirs, executors, administrators, successors and assigns, jointly and severally, firmly by these presents. WHEREAS, Contractor has by written agreement dated _____ entered into a contract with Owner for the Mechanic Street Pump Station Esthetic Improvements project in accordance with the specifications, and drawings prepared by **TMS Architects** on behalf of the City of Portsmouth, 1 Junkins Avenue, Portsmouth, N.H. 03801; which contract is by reference made a part hereof, and is hereinafter referred to as the Contract.

NOW, THEREFORE, THE CONDITION OF THIS OBLIGATION is such that if the Contractor shall well and faithfully do and perform the things agreed by him to be done and performed, according to the terms of said Contract and such alterations as may be made in said Contract during progress work, and shall further indemnify and save harmless the said Owner in accordance with the Contract, and shall remedy without cost to the Owner any defect which may develop within one year from the time of completion and acceptance of the work.

The Surety hereby waives notice of any alteration in work or extension of time made by the Owner or any of its agents or representatives.

Whenever Contractor shall be, and declared by Owner to be, in default under the Contract, the Owner having performed Owner's obligations thereunder, the Surety may promptly remedy the default, or shall promptly:

- (1) Complete the Contract in accordance with its terms and conditions, or
- (2) Obtain a bid or bids for submission to the Owner for completing the Contract in accordance with its terms and conditions, and upon determination by Owner and Surety of the lowest responsible Bidder, arrange for a contract between such Bidder and Owner and make available as work progresses (even though there should be a default or a succession of defaults under the contract of completion arranged under this paragraph) sufficient funds to pay the cost of completion less the balance of the contract price; but not exceeding, including other costs and damages for which the Surety may be liable hereunder, the amount set forth in the first paragraph hereof. The term "balance of the contract price", as used in this paragraph, shall mean the total amount payable by the Owner to Contractor under the Contract and any amendments thereto, less the amount paid by Owner to Contractor.

Any suit under this bond must be instituted before the expiration of (2) years from the date on which final payment under the contract falls due.

LABOR AND MATERIAL PAYMENT BOND

(This format provided for convenience, actual Labor and Material Bond is acceptable in lieu, if compatible)

Bond Number _____

KNOW ALL MEN BY THESE PRESENTS:

that _____

as Principal, hereinafter called Contractor, and _____ (Surety Company) a corporation organized and existing under the laws of the State of

_____ and authorized to do business in the State of New Hampshire hereinafter called Surety, are held and firmly bound unto the City of Portsmouth, N.H. Obligee, hereinafter called Owner, for the use and benefit of claimants as herein below defined, in the

amount of _____ Dollars (\$ _____), for the payment whereof Principal and Surety bind themselves, their heirs, executors, administrators, successors and assigns, jointly and severally, firmly by these presents.

WHEREAS, Principal has by written agreement dated _____ entered into a contract with Owner for _____ in accordance with the specifications, and drawings prepared by **TMS Architects** on behalf of the City of Portsmouth, 1 Junkins Avenue, Portsmouth, N.H. 03801; which contract is by reference made a part hereof, and is hereinafter referred to as the Contract.

NOW, THEREFORE, THE CONDITION OF THIS OBLIGATION is such that the Principal shall promptly make payment to all claimants as hereinafter defined, for all labor and material used or reasonably required for use in the performance of the Contract and for the hire of all equipment, tools, and all other things contracted for or used in connection therewith, then this obligation shall be void, otherwise it shall remain in full force and effect, subject however, to the following conditions:

(1) A claimant is defined as one having a direct contract with the Principal or, with a subcontractor of the Principal for labor, material, equipment, or other things used or reasonably required for use in the performance of the Contract. "Labor and material" shall include but not be limited to that part of water, gas, power, light, heat, oil and gasoline, telephone service or rental of equipment applicable to the Contract.

(2) The above named Principal and Surety hereby jointly and severally agree with the Owner that every claimant as herein defined, who has not been paid in full before the expiration of a period of ninety (90) days after the date on which the last of such claimant's work or labor was done or performed, or materials were furnished by such a claimant, may sue on this bond for the use of such claimant, prosecute the suit by final judgment for such sum or sums as may be justly due claimant, and have execution thereon. The Owner shall not be liable for the payment of any such suit or any costs or expenses of any such suit, and principal and surety shall jointly and severally indemnify, defend and hold the Owner harmless for any such suit, costs or expenses.

(3) No suit or action shall be commenced hereunder by any claimant:

LABOR AND MATERIAL PAYMENT BOND (continued)

(a) Unless Claimant, other than one having a direct contract with the Principal, shall have given notice to all the following:

The Principal, the Owner and the Surety above named, within six (6) calendar months after such claimant did or performed the last of the work or labor, or furnished the last of the materials for which said claim is made, stating with substantial accuracy the amount claimed and the name of the party to whom the materials were furnished, or for whom the work or labor was done or performed. Such notice shall be served by mailing the same by registered mail or certified mail, postage prepaid, in an envelope addressed to the Principal, Owner, and Surety, at any place where an office is regularly maintained for the transaction of business, or served in any manner in which legal process may be served in the State of New Hampshire save that such service need not be made by a public officer.

(b) After the expiration of one (1) year following the date on which Principal ceased all work on said contract, it being understood, however, that if any limitation embodied in this bond is prohibited by any law controlling the construction hereof, such limitation shall be deemed to be amended so as to be equal to the minimum period of limitation permitted by such law.

(c) Other than in a State court of competent jurisdiction in and for the county or other political subdivision of the State in which the project, or any part thereof, is situated, or in the United States District Court for the district in which the project, or any part thereof, is situated, and not elsewhere. (4) The amount of this bond may be reduced by and to the extent of any payment of payments made in good faith hereunder, inclusive of the payment by Surety of mechanics' liens which may be filed on record against said improvement, whether or not claim for the amount of such lien by presented under and against this bond.

Signed and sealed this _____ day of _____, 20____. In the presence of:

(Witness) BY: _____
(Principal) (Seal)

(Surety Company)

(Witness) BY: _____
(Title) (Seal)

Note:

If the Principal (Contractor) is a partnership, the Bond should be signed by each of the partners.

If the Principal (Contractor) is a corporation, the Bond should be signed in its correct corporate name by its duly authorized Officer or Officers.

If this bond is signed on behalf of the Surety by an attorney-in-fact, there should be attached to it a duly certified copy of his Power of Attorney showing his authority to sign such Bonds.

There should be executed an appropriate number of counterparts of the bond corresponding to the number of counterparts of the Agreement.

MAINTENANCE BOND

At the Owner's election, a maintenance bond may be substituted for retainage at the completion of the project. If the Owner permits a maintenance bond, it shall be in the amount of **Twenty Percent (20%)** of the contract price with a corporate surety approved by the Owner. Such bond shall be provided at the time of Contract completion and shall guarantee the repair of all damage due to faulty materials or workmanship provided or done by the Contractor. This guarantee shall remain in effect for a period of one year after the date of final acceptance of the job by the Owner.

CONTRACTOR'S AFFIDAVIT

STATE OF _____:

COUNTY OF _____:

Before me, the undersigned, a _____
(Notary Public, Justice of the Peace)

in and for said County and State personally appeared, _____
(Individual, Partner, or duly authorized representative of Corporate)

who, being duly sworn, according to law deposes and says that the cost of labor, material, and equipment and outstanding claims and indebtedness of whatever nature arising out of the performance of the Contract between

CITY OF PORTSMOUTH, NEW HAMPSHIRE

and _____
(Contractor)

of _____

Dated: _____

has been paid in full for Construction of: **Mechanic Street Pump Station Esthetic Improvements**

(Individual, Partner, or
duly authorized
representative of
Corporate Contractor)

Sworn to and subscribed
before me this _____ day
of _____ 20____

CONTRACTOR'S RELEASE

KNOW ALL MEN BY THESE PRESENTS that

I, _____ {insert name},
in my capacity as _____ {insert title}
of _____ {insert name of Contractor}

agree that upon receipt of the sum of \$_____ from the CITY
OF PORTSMOUTH NEW HAMPSHIRE as final and completed payment for the construction
of: _____ {insert name of project}

do hereby on behalf of _____ {name of Contractor} and its
successors and assigns release, quit-claim and forever discharge the City of Portsmouth, New
Hampshire, its successors and assigns, of and from all claims and demands arising from or in
connection with the construction of the above-referenced project and the contract dated
_____. All claims and demands shall include without limitation all actions, causes,
suits, debts, dues, duties, sums of money, accounts, reckonings, bonds, bills, specifications,
covenants, contracts, agreements, promises, damages and judgments whatsoever in law or equity
against the City of Portsmouth, New Hampshire which Contractor ever had, now has or may
have, for, upon or by reason of any matter, cause, or thing whatsoever; from the beginning of
record time to the date of these presents.

IN WITNESS WHEREOF,

Witness

Contractor:

print name : _____

By: _____
Its Duly Authorized _____

Dated: _____

GENERAL REQUIREMENTS**SCOPE OF WORK****1. INTENT OF CONTRACT**

The intent of the Contract is to provide for the construction and completion in every detail of the work described. The Contractor shall furnish all labor, materials, equipment, tools, transportation and supplies required to complete the work in accordance with the terms of the Contract. The Contractor shall be required to conform to the intent of the plans and specifications. No extra claims shall be allowed for portions of the work not specifically addressed in the plans and specifications but required to produce a whole and complete project, such work will be considered subsidiary to the bid items.

2. INCIDENTAL WORK

Incidental work items for which separate payment is not measured includes, but is not limited to, the following items:

- a. General clean up
- b. Maintaining a clean jobsite and exterior of building
- c. Signs & barricades
- d. Mobilization/Demobilization
- e. Restoration of property
- f. Cooperation and coordination with other contractors, abutters and utilities.
- g. Clearing, grubbing and stripping
- h. Steel and/or wood sheeting as required.
- i. Accessories and fasteners or components required to make items complete and functional.

3. ALTERATION OF PLANS OR OF CHARACTER OF WORK

The Owner reserves the right, without notice to Surety, to make such alterations of the plans or of the character of the work as may be necessary or desirable to complete fully and acceptably the proposed construction; provided that such alterations do not increase or decrease the contract cost. Within these cost limits, the alterations authorized in writing by the Owner shall not impair or affect any provisions of the Contract or bond and such increases or decreases of the quantities as a result from these alterations or deletions of certain items, shall not be the basis of claim for loss or for anticipated profits by the contractor. The contractor shall perform the work as altered at the contract unit price or prices.

4. EXTRA WORK ITEMS

Extra work shall be performed by the Contractor in accordance with the specifications and as directed, and will be paid for at a price as provided in the Contract documents or if such pay items are not applicable than at a price negotiated between the contractor and the Owner or at the unit bid price. If no agreement can be negotiated, the Contractor will accept as payment for extra work, cost plus 15% (overhead & profit). Costs shall be substantiated by invoices and certified payroll. If the Owner determines that extra work is to be performed, a change order will be issued.

5. CHANGE ORDERS

The Owner reserves the right to issue a formal change order for any increase, decrease, deletion, or addition of work or any increase in contract time or price. The contractor shall be required to sign the change order and it shall be considered as part of the Contract documents.

6. FINAL CLEANING UP

Before acceptance of the work, the contractor shall remove from the site all machinery, equipment, surplus materials, rubbish, temporary buildings, barricades and signs. All parts of the work shall be left in a neat and presentable condition. On all areas used or occupied by the contractor, regardless of the contract limits, the bidder shall clean-up all sites and storage grounds.

The items prescribed herein will not be paid for separately, but shall be paid for as part of the total contract price.

7. ERRORS AND INCONSISTENCY IN CONTRACT DOCUMENTS

Any provisions in any of the Contract Documents that may be in conflict with the paragraphs in these General Requirements shall be subject to the following order of precedence for interpretation.

1. Specifications and Special Provisions will govern General Requirements.

CONTROL OF WORK

1. AUTHORITY OF ENGINEER

(a) All work shall be done under supervision of the City Engineer and to his satisfaction. The City Engineer will decide all questions which may arise as to the quality and acceptability of materials furnished and work performed and as to the rate of progress of the work; all questions that may arise as to the interpretation of the plans and specifications; and all questions as to the acceptable fulfillment of the Contract by the Contractor.

(b) The City Engineer will have the authority to suspend the work wholly or in part for such periods as he may deem necessary due to the failure of the Contractor to correct conditions unsafe for workers or the general public; for failure to carry out provisions of the Contract; for failure to carry out orders; for conditions considered unsuitable for the prosecution of the work, including unfit weather; or for any other condition or reason deemed to be in the public interest. The Contractor shall not be entitled any additional payments arising out of any such suspensions.

(c) The Owner reserves the right to demand a certificate of compliance for a material or product used on the project. When the certificate of compliance is determined to be unacceptable to the City Engineer the Contractor may be required to provide engineering and testing services to guarantee that the material or product is suitable for use in the project, at its expense.

2. PROTECTION AND RESTORATION OF PROPERTY AND LANDSCAPES

(a) The Contractor shall use every precaution to prevent injury or damage to wires, poles, or other property of public utilities; trees, shrubbery, crops, and fences along and adjacent to the right-of-way, all underground structures such as pipes and conduits, within or outside of the right-of-way; and the Contractor shall protect and carefully preserve all property marks until an authorized agent has witnessed or otherwise referenced their location.

(b) The Contractor shall be responsible for all damage or injury to property of any character, during the prosecution of the work, resulting from any act, omission, neglect, or misconduct in his manner or method of executing the work, or at any time due to defective work or materials, and said responsibility will not be released until the project shall have been completed and accepted.

(c) When or where any direct or indirect damage or injury is done to public or private property by or on account of any act, omission, neglect, or misconduct in the execution of the work, or as a result of the failure to perform work by the Contractor, the Contractor shall restore, at its own expense, such property to a condition similar or equal to that existing before such damage or injury was done, by repairing rebuilding, or otherwise restoring as may be directed, or the Contractor shall make good such damage or injury in an acceptable manner.

(d) The Contractor shall paint with tree paint all scars made on fruit or ornamental trees by equipment, construction operations, or the removal of limbs larger than one inch in diameter. Damaged trees must be replaced if so determined by the City Arborist, in his or her sole discretion.

(e) If the Contractor fails to repair, rebuild or otherwise restore such property as may be deemed necessary, the Owner, after 48 hours notice, may proceed to do so, and the cost thereof may be deducted from any money due or which may become due the Contractor under the contract.

CONTROL OF WORK (continued)

(f) It is the intent of the Parties that the Contractor preserve, to as great an extent as possible, the historic & natural features of the site.

3. MAINTENANCE DURING CONSTRUCTION

The Contractor shall maintain the work during construction and until the project is accepted. This maintenance shall constitute continuous and effective work prosecuted day by day, with adequate equipment and workers to ensure that the structure is kept in satisfactory conditions at all times.

4. SAFETY PRECAUTIONS

Upon commencement of work, the Contractor shall be responsible for initiating, maintaining and supervising all safety precautions necessary to ensure the safety of employees on the site, other persons who may be affected thereby, including the public, and other property at the site or adjacent thereto.

5. PERMITS

It will be the responsibility of the Contractor to obtain all permits required for the operation of equipment in, or on, all city streets and public ways.

6. BARRICADES, WARNING SIGNS AND TRAFFIC OFFICERS

(a) The Contractor shall provide, erect and maintain all necessary barricades, suitable and sufficient lights, danger signals, signs and other traffic control devices, and shall take all necessary precautions for the protection of the work and safety of the public. Roadway closed to traffic shall be protected by effective barricades. Obstructions shall be illuminated during hours of darkness. Suitable warning signs shall be provided to control and direct traffic in a proper manner, as approved by the engineer.

(b) The Contractor will be held responsible for all damage to the work from traffic, pedestrians, animals or any other cause due to lack of adequate controlling devices.

The work prescribed herein will not be paid for separately but will be paid for as part of the Contract Price unless specifically appearing as a bid item.

INSURANCE REQUIREMENTS

Insurance shall be in such form as will protect the Contractor from all claims and liabilities for damages for bodily injury, including accidental death, and for property damage, which may arise from operations under this contract whether such operation by himself or by anyone directly or indirectly employed by him.

AMOUNT OF INSURANCE

- A) Comprehensive General Liability:
Bodily injury or Property Damage - \$2,000,000
Per occurrence and general aggregate
- B) Automobile and Truck Liability:
Bodily Injury or Property Damage - \$2,000,000
Per occurrence and general aggregate

Coverage requirements can be met with excess policies

Additionally, the Contractor shall purchase and maintain the following types of insurance:

- A) Full Workers Comprehensive Insurance coverage for all people employed by the Contractor to perform work on this project. This insurance shall at a minimum meet the requirements of the most current laws of the State of New Hampshire.
- B) Contractual Liability Insurance coverage in the amounts specified above under Comprehensive General Liability.
- C) Product and Completed Operations coverage to be included in the amounts specified above under Comprehensive General Liability.
- D) Builder's Risk in the amount of the contract.

ADDITIONAL INSURED

All liability policies (including any excess policies used to meet coverage requirements) shall include the City of Portsmouth, New Hampshire as named Additional Insureds.

- 1) The contractor's insurance shall be primary in the event of a loss.
- 2) The Additional Insured endorsement must include language specifically stating that the entity is to be covered for all activities performed by, or on behalf of, the contractor, including the City of Portsmouth's general supervision of the contractor.
- 3) City of Portsmouth shall be listed as a Certificate Holder. The City shall be identified as follows:

City of Portsmouth
Attn: Legal Department
1 Junkins Avenue
Portsmouth, NH 03801

TEMPORARY FACILITIES

1. STORAGE FACILITIES

(a) The Contractor shall not store materials or equipment in a public right-of-way beyond the needs of one working day. Equipment and materials shall be stored in a location approved by the Owner.

(b) The Contractor shall protect all stored materials from damage by weather or accident and shall insure adequate drainage at and about the storage location.

(c) Prior to final acceptance of the work all temporary storage facilities and surplus stored materials shall be removed from the site.

2. SANITARY FACILITIES

The Contractor shall provide toilet facilities for the use of the workers employed on the work. The location of any temporary toilet facilities must be approved by Owner.

3. WATER FACILITIES

The Owner shall provide the Contractor with reasonable access to water facilities for construction operations. The Contractor at times may be responsible for providing water for project related needs.

4. TEMPORARY ELECTRICITY

The Owner shall provide the Contractor with reasonable access to electrical power necessary for construction operation at the site.

MEASUREMENT AND PAYMENT

1. MEASUREMENT OF QUANTITIES

- (a) All work completed under the contract will be measured according to the United States standard measure.
- (b) The method of measurement and computations to be used in determination of quantities of material furnished and of work performed under the contract will be those methods generally recognized as conforming to good engineering practice. Unless otherwise stated all quantities measured for payment shall be computed or adjusted for "in place" conditions.
- (c) Unless otherwise specified, longitudinal measurements for area computations will be made horizontally, and no deductions will be made for individual fixtures having an area of 9 square feet or less. Unless otherwise specified, transverse measurements for area computations will be the dimensions shown on the plans or ordered in writing.
- (d) Structures will be measured according to lines shown on the plans or as ordered unless otherwise provided for elsewhere in the specifications.
- (e) In computing volumes of excavation, embankment, and borrow, the average end area method will be used. Where it is impracticable to measure by the cross-section method, acceptable methods involving three-dimensional measurement may be used. When measurement of borrow in vehicles is permitted, the quantity will be determined as 80 percent of the loose volume.
- (f) In computing volumes of concrete, stone and masonry, the prismatic method will be used. The term "ton" will mean the short ton consisting of 2,000 pounds avoirdupois.
- (g) Except as specified below, all materials that are measured or proportioned by weight shall be weighed on scales which the Contractor has had sealed by the State or by a repairman registered by the Commissioner of Agriculture. All weighing shall be performed in a manner prescribed under the Rules and Regulations of the Bureau of Weights and Measures of the New Hampshire Department of Agriculture.
- (h) Weighing of materials on scales located outside New Hampshire will be permitted for materials produced or stored outside the state, when requested by the Contractor and approved. Out-of-state weighing in order to be approved, must be performed by a licensed public weigh master or a person of equal authority in the state concerned on scales accepted in the concerned state.
- (i) Each truck used to haul material being paid for by weight shall bear a plainly legible identification mark, and if required, shall be weighed empty daily at such times as directed.
- (j) When material is weighed, the individual weight slips, which shall be furnished by the Contractor, for trucks, trailers, or distributors, shall show the following information: the date; the project; the material or commodity; the dealer or vendor; the Contractor or Subcontractor; the location of the scales; the vehicle registration number or other approved legible identification mark; the tare and net weights, with gross weights when applicable; and the weigher's signature or his signed initials.
- (k) The right is reserved to weight any truck, trailer, or distributor, at locations designated, before and after making deliveries to the project.

MEASUREMENT AND PAYMENT (continued)

(l) Bituminous materials will be measured by the gallon or ton.

(m) When material is specified to be measured by the cubic yard but measurement by weight is approved, such material may be weighed and the weight converted to cubic yards for payment purposes. Necessary conversion factors will be determined by the Owner.

(n) The term "lump sum" when used as an item of payment will mean complete payment for the work described in the item.

(o) When a complete structure or structural unit (in effect, "lump sum" work) is specified as the unit of measurement, the unit will be construed to include all necessary fittings and accessories, so as to provide the item complete and functional. Except as may be otherwise provided, partial payments for lump sum items will be made approximately in proportion to the amount of the work completed on those items.

(p) Material wasted without authority will not be included in the final estimate.

2. SCOPE OF PAYMENT

(a) The Contractor shall receive and accept compensation provided for in the contract as full payment for furnishing all materials and for performing all work under the contract in a complete and acceptable manner and for all risk, loss, damage or expense of whatever character arising out of the nature of the work or the prosecution thereof.

(b) The Contractor shall be liable to the Owner for failure to repair, correct, renew or replace, at his own expense, all damage due or attributable to defects or imperfections in the construction which defects or imperfections may be discovered before or at the time of the final inspection and acceptance of the work.

(c) No monies, payable under the contract or any part thereof, shall become due or payable if the Owner so elects, until the Contractor shall satisfy the Owner that the Contractor has fully settled or paid all labor performed or furnished for all equipment hired, including trucks, for all materials used, and for fuels, lubricants, power tools, hardware and supplies purchased by the Contractor and used in carrying out said contract and for labor and parts furnished upon the order of said Contractor for the repair of equipment used in carrying out said contract; and the Owner, if he so elects, may pay any and all such bills, in whole or in part.

3. PAYMENT PROCEDURES

Submit Application for Payment after completion of Project closeout procedures with release of liens and supporting documentation. Include consent of surety to final payment and insurance certificates.

4. COMPENSATION FOR ALTERED QUANTITIES

(a) Except as provided for under the particular contract item, when the accepted quantities of work vary from the quantities in the bid schedule the Contractor shall accept as payment in full, so far as contract items are concerned, at the original contract unit prices for the accepted quantities of work done. No allowance will be made for any increased expense, loss of expected reimbursement, or loss of anticipated profits suffered or claimed by the Contractor resulting either directly from such alterations or indirectly from unbalanced allocation among the contract items of overhead expense on the part of the Bidder and subsequent loss of expected reimbursements therefore or from any other cause.

MEASUREMENT AND PAYMENT (continued)

(b) Extra work performed will be paid for at the contract bid prices or at the price negotiated between the Owner and the Contractor if the item was not bid upon. If no agreement can be negotiated, the Contractor will accept as payment for extra work, cost plus 15% (overhead and profit). Costs shall be substantiated by invoices and certified payroll.

5. PARTIAL PAYMENTS

Partial payments will be made on a monthly basis during the contract period. From the total amount ascertained as payable, an amount equivalent to ten percent (10%) of the whole will be deducted and retained by the Owner until such time as the work receives final acceptance.

6. FINAL ACCEPTANCE

Upon due notice from the Contractor of presumptive completion of the entire project, the Owner and City Engineer will make an inspection. If all construction provided for and contemplated by the contract is found complete to their satisfaction, this inspection shall constitute the final inspection and the Owner or City Engineer will make the final acceptance and notify the Contractor in writing of this acceptance as of the date of the final inspection.

If, however, the City Engineer's inspection discloses any work in whole or in part, as being unsatisfactory, the Engineer will give the Contractor the necessary instructions for correction of such work, and the Contractor shall immediately comply with and execute such instructions. Upon correction of the work, another inspection will be made which shall constitute the final inspection provided the work has been satisfactorily completed. In such event, the City Engineer will make the final acceptance and notify the Contractor in writing of this acceptance as of the date of final inspection.

7. ACCEPTANCE AND FINAL PAYMENT

(a) When the project has been accepted and upon submission by the Contractor of all required reports, completed forms and certifications, the Owner will review the final estimate of the quantities of the various classes of work performed. The Contractor may be required to certify that all bills for labor and material used under this contract have been paid.

(b) The Contractor shall file with the Owner any claim that the Contractor may have regarding the final estimate at the same time the Contractor submits the final estimate. Failure to do so shall be a waiver of all such claims and shall be considered as acceptance of the final estimate. From the total amount ascertained as payable, an amount equal to ten percent (10%) of the whole will be deducted and retained by the Owner for the guaranty period. This retainage may be waived, at the discretion of the City, provided the required Maintenance Bond has been posted. After approval of the final estimate by the Owner, the Contractor will be paid the entire sum found to be due after deducting all previous payments and all amounts to be retained or deducted under the provisions of the contract.

(c) All prior partial estimates and payments shall be subject to correction in the final estimate and payment.

MEASUREMENT AND PAYMENT (continued)

8. GENERAL GUARANTY AND WARRANTY OF TITLE

(a) Neither the final certification of payment nor any provision in the contract nor partial or entire use of the improvements embraced in this Contract by the Owner or the public shall constitute an acceptance of work not done in accordance with the Contract or relieve the Contractor of liability in respect to any express or implied warranties or responsibility for faulty materials or workmanship. The Contractor shall promptly remedy any defects in the work and pay for any damage to other work resulting there from which shall appear within a period of twelve (12) months from the date of final acceptance of the work. The Owner will give notice of defective materials and work with reasonable promptness.

(b) No material, supplies or equipment to be installed or furnished under this Contract shall be purchased subject to any chattel mortgage or under a conditional sale, lease purchase or other agreement by which an interest therein or in any part thereof is retained by the Seller or supplier. The Contractor shall warrant good title to all materials, supplies and equipment installed or incorporated in the work and upon completion of all work, shall deliver the same together with all improvements and appurtenances constructed or placed thereon by him to the Owner free from any claims, liens or charges. Neither the Contractor nor any person, firm or corporation furnishing any material or labor for any work covered by this Contract shall have the right to a lien upon any improvements or appurtenances thereon.

Nothing contained in this paragraph, however, shall defeat or impair the right of persons furnishing materials or labor to recover under any bond given by the Contractor for their protection or any rights under any law permitting such persons to look to funds due the Contractor in the hands of the Owner. The provisions of this paragraph shall be inserted in all subcontractors and material contracts and notice of its provisions shall be given to all persons furnishing materials for the work when no formal contract is entered into for such materials.

(c) At completion of project, Contractor to provide to Owner, written guarantee of one (1) year Workmanship warranty; and one (1) year Manufacturer's warranty.

9. NO WAIVER OF LEGAL RIGHTS

(a) Upon completion of the work, the Owner will expeditiously make final inspection and notify the Contractor of acceptance. Such final acceptance, however, shall not preclude or stop the Owner from correcting any measurement, estimate, or certificate made before or after completion of the work, nor shall the Owner be precluded or be stopped from recovering from the Contractor or his Surety, or both, such overpayment as it may sustain by failure on the part of the Contractor to fulfill his obligations under the contract. A waiver on the part of the Owner of any breach of any part of the contract shall not be held to be a waiver of any other or subsequent breach.

(b) The Contractor, without prejudice to the Contract shall be liable to the terms of the Contract, shall be liable to the Owner for latent defects, fraud or such gross mistakes as may amount to fraud, and as regards the Owner's right under any warranty or guaranty.

10. TERMINATION OF CONTRACTOR'S RESPONSIBILITY

Whenever the improvement provided for by the Contract shall have been completely performed on the part of the Contractor and all parts of the work have been released from further obligations except as set forth in his bond and as provided in Section 8 above.

SHOP DRAWINGS

The Contractor shall submit working and detail drawings, well in advance of the work, to the City Engineer for review.

The Contractor's drawings shall consist of shop detail, erection and other working plans showing dimensions, sizes and quality of material, details and other information necessary for the complete fabrication and erection of the pertinent work.

The Contractor shall submit three (3) sets of drawings to the City Engineer.

Prior to the approval of the drawings, any work done or materials ordered for the work involved shall be at the Contractor's risk.

One set of the drawings will be returned to the Contractor approved or marked with corrections to be made. After approval has been given, the Contractor shall supply the City Engineer with two sets of the revised detail working drawings.

The City Engineer's approval of the Contractor's working drawings will not relieve the Contractor from responsibility for errors in dimensions or for incorrect fabrication processes, or from responsibility to complete the contract work.

ATTACHMENT A:

NH Department of Environmental Services Wetlands Permit #2012-02922



The State of New Hampshire
Department of Environmental Services

Thomas S. Burack, Commissioner



February 8, 2013

City of Portsmouth
C/o David Allen
Deputy City Manager
1 Junkins Avenue
Portsmouth, NH 03801

RE: NHDES Wetlands File # 2012-02922, City of Portsmouth, Mechanic Street Wastewater Pumping Station, Portsmouth Tax Map/Lot# 103/30

Dear Mr. Allen:

Attached please find Wetlands Permit # 2012-02922 to impact a total of 250 square feet in the developed upland tidal buffer zone for exterior facade improvements, landscaping, and hardscaping improvements to an existing building.

The decision to approve this application was based on the following findings:

1. This is a minimum impact project per Administrative Rule Env-Wt 303.04((b) Projects in previously-developed upland areas within 100 feet of the highest observable tide line unless they are major or minor as defined in Env-Wt 303.02 or Env-Wt 303.03, respectively.
2. The need for the proposed impacts has been demonstrated by the applicant per Env-Wt 302.01. The applicant has demonstrated the need for improvements to the exterior of an existing building.
3. The applicant has provided evidence which demonstrates that this proposal is the alternative with the least adverse impact to areas and environments under the department's jurisdiction per Env-Wt 302.03. The applicant has demonstrated that there will be no change in impervious area from existing conditions and will be providing additional plantings over current conditions.
4. The applicant has demonstrated by plan and example that each factor listed in Env-Wt 302.04(b)(d) Requirements for Application Evaluation, has been considered in the design of the project. The NH Natural Heritage Bureau ("NHB") has record of a sensitive specie present within the vicinity of the project area, but NHB does not expect impacts to this specie from the project.
5. The Portsmouth Conservation Commission signed the expedited application and has no objection to permitting the proposed work.

Any party may apply for reconsideration with respect to any matter determined in this action within 30 days from the date of this letter. A motion for reconsideration must specify all grounds upon which future appeals may be based, and should include information not available to DES when the decision was made. DES may grant reconsideration if, in its opinion, good reason is provided in the motion.

Your permit must be signed, and a copy must be posted in a prominent location on site during construction.

www.des.nh.gov
29 Hazen Drive • PO Box 95 • Concord, NH 03302-0095
(603) 271-3503 • TDD Access: Relay NH 1-800-735-2964

SPECIFICATIONS

SECTION 011000 – SUMMARY

SECTION 012900 – PAYMENT PROCEDURES

SECTION 013100 – PROJECT MANAGEMENT AND COORDINATION

SECTION 017300 – EXECUTION

SECTION 017700 – CLOSEOUT PROCEDURES

SECTION 027800 – BELGIAN BLOCK UNIT PAVING

SECTION 029300 – LANDSCAPING AND PLANTINGS

SECTION 055000 – METAL FABRICATION AND INSTALLATION

SECTION 062000 – WOOD FENCING

SECTION 064013 – EXTERIOR ARCHITECTURAL WOODWORK

SECTION 075323 – ETHYLENE-PROPYLENE-DIENE-MONOMER (EPDM) ROOFING

SECTION 099100 – PAINTING

SECTION 165000 – LIGHTING

SECTION 011000 - SUMMARY

PART 1 - GENERAL

1.1 SUMMARY

- A. This Section includes the following:
 - 1. Work covered by the Contract Documents.
 - 2. Use of premises.
 - 3. Specification formats and conventions.

1.2 WORK COVERED BY CONTRACT DOCUMENTS

- A. Project Identification: Mechanic Street Pump Station Esthetic Improvements.
 - 1. Project Location: 113 Mechanic Street, Portsmouth, NH 03801.
- B. Owner: City Of Portsmouth, New Hampshire.
 - 1. Owner's Representative: City Of Portsmouth DPW
- C. Architect: TMS Architects, Portsmouth, NH
- D. The Work consists of the following:
 - 1. The work shall consist of esthetic improvements to the Mechanic Street Pump Station building and property, including a steel parapet, fencing, plantings, cobble stone walkway, trellis, and lighting as shown on Contract Drawings.
- E. Project will be constructed under a single prime contract and in a single phase.

1.3 USE OF PREMISES

- A. General: Contractor shall have limited use of premises for construction operations as indicated on Drawings by the Contract limits.
- B. Use of Site: Limit use of premises to work in areas indicated. Do not disturb portions of Project site beyond areas in which the Work is indicated.
 - 1. Use of site shall comply with requirements outlined in New Hampshire Department of Environmental Services Wetland Permit #2102-02922, a copy of which is included in the Contract Documents at 'Attachment A'.
- C. Use of Existing Building: Existing building will not be available for use, storage of material or equipment, meetings, etc. Repair damage caused by construction operations. Protect building and its occupants during construction period.

1.4 OWNER'S OCCUPANCY REQUIREMENTS

- A. Owner Occupancy: Owner will not occupy the premises, but be maintaining and monitoring the operations of the building continuously during the construction period. Cooperate with Owner during construction operations to minimize conflicts.
 - 1. Maintain access to existing walkways, corridors, and other adjacent occupied or used facilities. Do not close or obstruct walkways, corridors, or other occupied or used facilities without written permission from Owner and authorities having jurisdiction.
 - 2. This pump station is the largest in the City collection system and operates 24 hours per day, seven days per week. Under no circumstance shall the contractor's operations impact continuous operation of the pump station.

1.5 SPECIFICATION FORMATS AND CONVENTIONS

- A. Specification Format: The Specifications are organized into Divisions and Sections using the 16-division format and CSI/CSC's "Master Format" numbering system.
- B. Specification Content: The Specifications use certain conventions for the style of language and the intended meaning of certain terms, words, and phrases when used in particular situations. These conventions are as follows:
 - 1. Abbreviated Language: Language used in the Specifications and other Contract Documents is abbreviated. Words and meanings shall be interpreted as appropriate. Words implied, but not stated, shall be inferred as the sense requires. Singular words shall be interpreted as plural, and plural words shall be interpreted as singular where applicable as the context of the Contract Documents indicates.
 - 2. Imperative mood and streamlined language are generally used in the Specifications. Requirements expressed in the imperative mood are to be performed by Contractor. Occasionally, the indicative or subjunctive mood may be used in the Section Text for clarity to describe responsibilities that must be fulfilled indirectly by Contractor or by others when so noted.
 - a. The words "shall," "shall be," or "shall comply with," depending on the context, are implied where a colon (:) is used within a sentence or phrase.

PART 2 - PRODUCTS (Not Used)

PART 3 - EXECUTION (Not Used)

END OF SECTION 011000

SECTION 012900 - PAYMENT PROCEDURES

PART 1 - GENERAL

1.1 SUMMARY

- A. This Section specifies administrative and procedural requirements necessary to prepare and process Applications for Payment.

1.2 SCHEDULE OF VALUES

- A. Coordination: Coordinate preparation of the Schedule of Values with preparation of Contractor's Construction Schedule.
 - 1. Correlate line items in the Schedule of Values with other required administrative forms and schedules, including Application for Payment forms with Continuation Sheets Submittals Schedule and Contractor's Construction Schedule.
 - 2. Submit the Schedule of Values to Owner at earliest possible date but no later than seven days before the date scheduled for submittal of initial Applications for Payment.
- B. Format and Content: Use the Project Manual table of contents as a guide to establish line items for the Schedule of Values. Provide at least one line item for each Specification Section.
 - 1. Identification: Include the following Project identification on the Schedule of Values:
 - a. Project name and location.
 - b. Name of Owner.
 - c. Owner's project number.
 - d. Contractor's name and address.
 - e. Date of submittal.
 - 2. Submit draft of AIA Document G702 and AIA Document G703 Continuation Sheets.
 - 3. Provide a breakdown of the Contract Sum in enough detail to facilitate continued evaluation of Applications for Payment and progress reports. Coordinate with the Project Manual table of contents. Provide several line items for principal subcontract amounts, where appropriate.
 - 4. Round amounts to nearest whole dollar; total shall equal the Contract Sum.
 - 5. Provide a separate line item in the Schedule of Values for each part of the Work where Applications for Payment may include materials or equipment purchased or fabricated and stored, but not yet installed.
 - 6. Each item in the Schedule of Values and Applications for Payment shall be complete. Include total cost and proportionate share of general overhead and profit for each item.
 - 7. Schedule Updating: Update and resubmit the Schedule of Values before the next Applications for Payment when Change Orders or Construction Change Directives result in a change in the Contract Sum.

1.3 APPLICATIONS FOR PAYMENT

- A. Each Application for Payment shall be consistent with previous applications and payments as certified by Owner and paid for by Owner.
 - 1. Initial Application for Payment, Application for Payment at time of Substantial Completion, and final Application for Payment involve additional requirements.
- B. Payment Application Times: The date for each progress payment is indicated in the Agreement between Owner and Contractor. The period of construction Work covered by each Application for Payment is the period indicated in the Agreement.
- C. Payment Application: The period covered by each Application for Payment is one month, ending on the last day of the month.
- D. Payment Application Forms: Use AIA Document G702 and AIA Document G703 Continuation Sheets as form for Applications for Payment.
- E. Application Preparation: Complete every entry on form. Notarize and execute by a person authorized to sign legal documents on behalf of Contractor. Owner will return incomplete applications without action.
 - 1. Entries shall match data on the Schedule of Values and Contractor's Construction Schedule. Use updated schedules if revisions were made.
 - 2. Include amounts of Change Orders and Construction Change Directives issued before last day of construction period covered by application.
- F. Transmittal: Submit 3 signed and notarized original copies of each Application for Payment to Owner by a method ensuring receipt within 24 hours. One copy shall include waivers of lien and similar attachments as required by the City Of Portsmouth.
 - 1. Transmit each copy with a transmittal form listing attachments and recording appropriate information about application.
- G. Waivers of Mechanic's Lien: With each Application for Payment, submit waivers of mechanic's lien from every entity who is lawfully entitled to file a mechanic's lien arising out of the Contract and related to the Work covered by the payment.
 - 1. Submit partial waivers on each item for amount requested in previous application, after deduction for retainage, on each item.
 - 2. When an application shows completion of an item, submit final or full waivers.
 - 3. Owner reserves the right to designate which entities involved in the Work must submit waivers.
 - 4. Waiver Forms: Submit waivers of lien on forms, executed in a manner acceptable to Owner.
- H. Initial Application for Payment: Administrative actions and submittals that must precede or coincide with submittal of first Application for Payment include the following:
 - 1. List of subcontractors.
 - 2. Schedule of Values.

3. Contractor's Construction Schedule (preliminary if not final).
 4. Submittals Schedule (preliminary if not final).
 5. List of Contractor's site superintendent.
 6. Copies of authorizations and licenses from authorities having jurisdiction for performance of the Work.
 7. Certificates of insurance and insurance policies.
 8. Contractor's Lead Removal certification
- I. Application for Payment at Substantial Completion: After issuing the Certificate of Substantial Completion, submit an Application for Payment showing 100 percent completion for portion of the Work claimed as substantially complete.
1. Include documentation supporting claim that the Work is substantially complete and a statement showing an accounting of changes to the Contract Sum.
 2. This application shall reflect Certificates of Partial Substantial Completion issued previously for Owner occupancy of designated portions of the Work.
- J. Final Payment Application: Submit final Application for Payment with releases and supporting documentation not previously submitted and accepted, including, but not limited, to the following:
1. Evidence of completion of Project closeout requirements.
 2. Insurance certificates for products and completed operations where required and proof that taxes, fees, and similar obligations were paid.
 3. Updated final statement, accounting for final changes to the Contract Sum.
 4. Contractor's Affidavit of Payment of Debts and Claims.
 5. Contractor's Affidavit of Release of Liens.
 6. Consent of Surety to Final Payment.
 7. Evidence that claims have been settled.

PART 2 - PRODUCTS (Not Used)

PART 3 - EXECUTION (Not Used)

END OF SECTION 012900

SECTION 013100 - PROJECT MANAGEMENT AND COORDINATION

PART 1 - GENERAL

1.1 SUMMARY

- A. This Section includes administrative provisions for coordinating construction operations on Project including, but not limited to, the following:
 - 1. Project meetings.
 - 2. Requests for Information (RFIs).
- B. See Division 01 Section "Execution" for procedures for coordinating general installation and field-engineering services, including establishment of benchmarks and control points.

1.2 DEFINITIONS

- A. RFI: Request from Contractor seeking information, interpretation or clarification of the Contract Documents.

1.3 COORDINATION

- A. Coordination: Coordinate construction operations included in different Sections of the Specifications to ensure efficient and orderly installation of each part of the Work. Coordinate construction operations, included in different Sections, that depend on each other for proper installation, connection, and operation.
 - 1. Schedule construction operations in sequence required to obtain the best results where installation of one part of the Work depends on installation of other components, before or after its own installation.
 - 2. Coordinate installation of different components with other contractors to ensure maximum accessibility for required maintenance, service, and repair.
 - 3. Make adequate provisions to accommodate items scheduled for later installation.
 - 4. Where availability of space is limited, coordinate installation of different components to ensure maximum performance and accessibility for required maintenance, service, and repair of all components, including mechanical and electrical.
- B. Administrative Procedures: Coordinate scheduling and timing of required administrative procedures with other construction activities and activities of other contractors to avoid conflicts and to ensure orderly progress of the Work. Such administrative activities include, but are not limited to, the following:
 - 1. Preparation of Contractor's Construction Schedule.
 - 2. Preparation of the Schedule of Values.
 - 3. Installation and removal of temporary facilities and controls.
 - 4. Delivery and processing of submittals.
 - 5. Progress meetings.

6. Project closeout activities.

1.4 PROJECT MEETINGS

- A. General: Schedule and conduct meetings and conferences at Project site, unless otherwise indicated.
 1. Attendees: Inform participants and others involved, and individuals whose presence is required, of date and time of each meeting. Notify Owner and Owner of scheduled meeting dates and times.
- B. Preconstruction Conference: Schedule a preconstruction conference before starting construction, at a time convenient to Owner, but no later than 15 days after execution of the Agreement. Hold the conference at Project site or another convenient location. Conduct the meeting to review responsibilities and personnel assignments.
 1. Attendees: Authorized representatives of Owner, and their consultants; Contractor and its superintendent; major subcontractors; suppliers; and other concerned parties shall attend the conference. All participants at the conference shall be familiar with Project and authorized to conclude matters relating to the Work.
 2. Agenda: Discuss items of significance that could affect progress, including the following:
 - a. Tentative construction schedule.
 - b. Critical work sequencing and long-lead items.
 - c. Designation of key personnel and their duties.
 - d. Procedures for processing field decisions and Change Orders.
 - e. Procedures for RFIs.
 - f. Procedures for testing and inspecting.
 - g. Procedures for processing Applications for Payment.
 - h. Distribution of the Contract Documents.
 - i. Submittal procedures.
 - j. Use of the premises.
 - k. Work restrictions.
 - l. Responsibility for temporary facilities and controls.
 - m. Construction waste management and recycling.
 - n. Parking availability.
 - o. Office, work, and storage areas.
 - p. Equipment deliveries and priorities.
 - q. First aid.
 - r. Security.
 - s. Progress cleaning.
 - t. Working hours.
- C. Progress Meetings: Conduct progress meetings at weekly intervals. Coordinate dates of meetings with preparation of payment requests.
 1. Attendees: In addition to representatives of Owner, each contractor, subcontractor, supplier, and other entity concerned with current progress or involved in planning, coordination, or performance of future activities shall be represented at these meetings.

All participants at the conference shall be familiar with Project and authorized to conclude matters relating to the Work.

2. Contractor's Construction Schedule: Review progress since the last meeting. Determine whether each activity is on time, ahead of schedule, or behind schedule, in relation to Contractor's Construction Schedule. Determine how construction behind schedule will be expedited; secure commitments from parties involved to do so.
 - a. Review schedule for next period.
 - b. Review present and future needs, questions & concerns of each entity present.

1.5 REQUESTS FOR INFORMATION (RFIs)

- A. Procedure: Immediately on discovery of the need for information relative to the Contract Documents, and if not possible to request information at Project meeting, prepare and submit an RFI in the form specified.
 1. RFIs shall originate with Contractor. RFIs submitted by entities other than Contractor will be returned with no response.
 2. Coordinate and submit RFIs in a prompt manner so as to avoid delays in Contractor's work or work of subcontractors.
- B. Content of the RFI: Include a detailed, legible description of item needing interpretation and the following:
 1. Project name.
 2. Date.
 3. Name of Contractor.
 4. Name of Owner.
 5. RFI number, numbered sequentially.
 6. Specification Section number and title and related paragraphs, as appropriate.
 7. Drawing number and detail references, as appropriate.
 8. Field dimensions and conditions, as appropriate.
 9. Contractor's suggested solution(s). If Contractor's solution(s) impact the Contract Time or the Contract Sum, Contractor shall state impact in the RFI.
 10. Contractor's signature.
 11. Attachments: Include drawings, descriptions, measurements, photos, Product Data, Shop Drawings, and other information necessary to fully describe items needing interpretation.
- C. Hard-Copy RFIs.
 1. Identify each page of attachments with the RFI number and sequential page number.
- D. Owner's Action: Owner will review each RFI, determine action required, and return it. Allow seven working days for Owner's response for each RFI.
 1. The following RFIs will be returned without action:
 - a. Requests for approval of submittals.
 - b. Requests for approval of substitutions.
 - c. Requests for coordination information already indicated in the Contract Documents.

- d. Requests for adjustments in the Contract Time or the Contract Sum.
 - e. Requests for interpretation of Owner's actions on submittals.
 - f. Incomplete RFIs or RFIs with numerous errors.
2. Owner's action may include a request for additional information, in which case Owner's time for response will start again.
 3. Owner's action on RFIs that may result in a change to the Contract Time or the Contract Sum may be eligible for Contractor to submit Change Proposal.
 - a. If Contractor believes the RFI response warrants change in the Contract Time or the Contract Sum, notify Owner in writing within 10 days of receipt of the RFI response.
- E. On receipt of Owner's action, update the RFI log and immediately distribute the RFI response to affected parties. Review response and notify Owner within seven days if Contractor disagrees with response.
- F. RFI Log: Prepare, maintain, and submit a tabular log of RFIs organized by the RFI number. Submit log monthly. Include the following:
1. Project name.
 2. Name and address of Contractor.
 3. Name and address of Owner.
 4. RFI number including RFIs that were dropped and not submitted.
 5. RFI description.
 6. Date the RFI was submitted.
 7. Date Owner's response was received.
 8. Identification of related Minor Change in the Work, Construction Change Directive, and Proposal Request, as appropriate.
 9. Identification of related Field Order, Work Change Directive, and Proposal Request, as appropriate.

PART 2 - PRODUCTS (Not Used)

PART 3 - EXECUTION (Not Used)

END OF SECTION 013100

SECTION 017300 - EXECUTION

PART 1 - GENERAL

1.1 SUMMARY

- A. This Section includes general procedural requirements governing execution of the Work including, but not limited to, the following:
 - 1. General installation of products.
 - 2. Progress cleaning.
 - 3. Protection of installed construction.
 - 4. Correction of the Work.

- B. See Division 01 Section "Closeout Procedures" for submitting Project Record Documents, recording of Owner-accepted deviations from indicated lines and levels, and final cleaning.

PART 2 - PRODUCTS (Not Used)

PART 3 - EXECUTION

3.1 EXAMINATION

- A. Existing Conditions: The existence and location of site improvements, utilities, and other construction indicated as existing are not guaranteed. Before beginning work, investigate and verify the existence and location of mechanical and electrical systems and other construction affecting the Work.

- B. Acceptance of Conditions: Examine substrates, areas, and conditions, with Installer or Applicator present where indicated, for compliance with requirements for installation tolerances and other conditions affecting performance. Record observations.
 - 1. Verify compatibility with and suitability of substrates, including compatibility with existing finishes or primers.
 - 2. Proceed with installation only after unsatisfactory conditions have been corrected. Proceeding with the Work indicates acceptance of surfaces and conditions.

3.2 PREPARATION

- A. Existing Utility Information: Furnish information to Owner that is necessary to adjust, move, or relocate existing utility appurtenances located in or affected by construction. Coordinate with authorities having jurisdiction.

- B. Field Measurements: Take field measurements as required to fit the Work properly. Recheck measurements before installing each product. Where portions of the Work are indicated to fit to

other construction, verify dimensions of other construction by field measurements before fabrication. Coordinate fabrication schedule with construction progress to avoid delaying the Work.

- C. Space Requirements: Verify space requirements and dimensions of items shown diagrammatically on Drawings.
- D. Review of Contract Documents and Field Conditions: Immediately on discovery of the need for clarification of the Contract Documents, submit a request for information to Owner and Architect. Include a detailed description of problem encountered, together with recommendations for changing the Contract Documents.

3.3 CONSTRUCTION LAYOUT (Not Used)

3.4 FIELD ENGINEERING (Not Used)

3.5 INSTALLATION

- A. General: Locate the Work and components of the Work accurately, in correct alignment and elevation, as indicated.
 - 1. Make vertical work plumb and make horizontal work level.
 - 2. Where space is limited, install components to maximize space available for maintenance and ease of removal for replacement.
 - 3. Conceal pipes, ducts, and wiring in finished areas, unless otherwise indicated.
- B. Tools and Equipment: Do not use tools or equipment that produce harmful noise levels.
- C. Templates: Obtain and distribute to the parties involved templates for work specified to be factory prepared and field installed. Check Shop Drawings of other work to confirm that adequate provisions are made for locating and installing products to comply with indicated requirements.
- D. Anchors and Fasteners: Provide anchors and fasteners as required to anchor each component securely in place, accurately located and aligned with other portions of the Work.
 - 1. Mounting Heights: Where mounting heights are not indicated, mount components at heights directed by Owner.
 - 2. Coordinate installation of anchorages. Furnish setting drawings, templates, and directions for installing anchorages, including sleeves, concrete inserts, anchor bolts, and items with integral anchors, that are to be embedded in concrete or masonry. Deliver such items to Project site in time for installation.
- E. Joints: Make joints of uniform width. Where joint locations in exposed work are not indicated, arrange joints for the best visual effect. Fit exposed connections together to form hairline joints.
- F. Hazardous Materials: Use products, cleaners, and installation materials that are not considered hazardous.

3.6 PROGRESS CLEANING

- A. General: Clean Project site and work areas daily, including common areas. Coordinate progress cleaning for joint-use areas where more than one installer has worked. Enforce requirements strictly. Dispose of materials lawfully.
- B. Site: Maintain Project site free of waste materials and debris.
- C. Work Areas: Clean areas where work is in progress to the level of cleanliness necessary for proper execution of the Work.
 - 1. Remove liquid spills promptly.
 - 2. Where dust would impair proper execution of the Work, broom-clean or vacuum the entire work area, as appropriate.
- D. Installed Work: Keep installed work clean. Clean installed surfaces according to written instructions of manufacturer or fabricator of product installed, using only cleaning materials specifically recommended. If specific cleaning materials are not recommended, use cleaning materials that are not hazardous to health or property and that will not damage exposed surfaces.
- E. Concealed Spaces: Remove debris from concealed spaces before enclosing the space.
- F. Exposed Surfaces in Finished Areas: Clean exposed surfaces and protect as necessary to ensure freedom from damage and deterioration at time of Substantial Completion.
- G. Waste Disposal: Burying or burning waste materials on-site will not be permitted. Washing waste materials down sewers or into waterways will not be permitted.
- H. During handling and installation, clean and protect construction in progress and adjoining materials already in place. Apply protective covering where required to ensure protection from damage or deterioration at Substantial Completion.
- I. Clean and provide maintenance on completed construction as frequently as necessary through the remainder of the construction period. Adjust and lubricate operable components to ensure operability without damaging effects.
- J. Limiting Exposures: Supervise construction operations to assure that no part of the construction, completed or in progress, is subject to harmful, dangerous, damaging, or otherwise deleterious exposure during the construction period.

3.7 PROTECTION OF INSTALLED CONSTRUCTION

- A. Provide final protection and maintain conditions that ensure installed Work is without damage or deterioration at time of Substantial Completion.

3.8 CORRECTION OF THE WORK

- A. Repair or remove and replace defective construction. Restore damaged substrates and finishes. Comply with requirements in Division 01 Section

1. Repairing includes replacing defective parts, refinishing damaged surfaces, repairing any roof leaks as a result of this construction, touching up with matching materials, and properly adjusting operating equipment.
- B. Restore permanent facilities used during construction to their specified condition.
- C. Remove and replace damaged surfaces that are exposed to view if surfaces cannot be repaired without visible evidence of repair.

END OF SECTION 017300

SECTION 017700 - CLOSEOUT PROCEDURES

PART 1 - GENERAL

1.1 SUMMARY

- A. This Section includes administrative and procedural requirements for contract closeout, including, but not limited to, the following:
 - 1. Inspection procedures.
 - 2. Warranties.
 - 3. Final cleaning.
- B. See Division 01 Section "Payment Procedures" for requirements for Applications for Payment for Substantial and Final Completion.

1.2 SUBSTANTIAL COMPLETION

- A. Preliminary Procedures: Before requesting inspection for determining date of Substantial Completion, complete the following. List items below that are incomplete in request.
 - 1. Prepare a list of items to be completed and corrected (punch list), the value of items on the list, and reasons why the Work is not complete.
 - 2. Advise Owner of pending insurance changeover requirements.
 - 3. Submit specific warranties and similar documents.
 - 4. Obtain and submit releases permitting Owner unrestricted use of the Work and access to services and utilities.
 - 5. Prepare and submit Project Record Documents.
 - 6. Terminate and remove temporary facilities from Project site, along with mockups, construction tools, and similar elements.
 - 7. Complete final cleaning requirements, including touchup painting.
 - 8. Touch up and otherwise repair and restore marred exposed finishes to eliminate visual defects.
- B. Inspection: Submit a written request for inspection for Substantial Completion. On receipt of request, Owner will either proceed with inspection or notify Contractor of unfulfilled requirements. Owner will prepare the Certificate of Substantial Completion after inspection or will notify Contractor of items, either on Contractor's list or additional items identified by Owner, that must be completed or corrected before certificate will be issued.
 - 1. Reinspection: Request reinspection when the Work identified in previous inspections as incomplete is completed or corrected.
 - 2. Results of completed inspection will form the basis of requirements for Final Completion.

1.3 FINAL COMPLETION

- A. Preliminary Procedures: Before requesting final inspection for determining date of Final Completion, complete the following:
 - 1. Submit a final Application for Payment according to Division 01 Section "Payment Procedures."
 - 2. Submit certified copy of Owner's Substantial Completion inspection list of items to be completed or corrected (punch list). The certified copy of the list shall state that each item has been completed or otherwise resolved for acceptance.
 - 3. Submit evidence of final, continuing insurance coverage complying with insurance requirements.
- B. Inspection: Submit a written request for final inspection for acceptance. On receipt of request, Owner will either proceed with inspection or notify Contractor of unfulfilled requirements. Owner will prepare a final Certificate for Payment after inspection or will notify Contractor of construction that must be completed or corrected before certificate will be issued.
 - 1. Reinspection: Request reinspection when the Work identified in previous inspections as incomplete is completed or corrected.

1.4 LIST OF INCOMPLETE ITEMS (PUNCH LIST)

- A. Preparation: Submit three copies of list. Include name and identification of each area affected by construction operations for incomplete items and items needing correction including, if necessary, areas disturbed by Contractor that are outside the limits of construction.

1.5 WARRANTIES

- A. Submittal Time: Submit written warranties on request of Owner for designated portions of the Work where commencement of warranties other than date of Substantial Completion is indicated.

PART 2 - PRODUCTS

2.1 MATERIALS

- A. Cleaning Agents: Use cleaning materials and agents recommended by manufacturer or fabricator of the surface to be cleaned. Do not use cleaning agents that are potentially hazardous to health or property or that might damage finished surfaces.

PART 3 - EXECUTION**3.1 FINAL CLEANING**

- A. General: Provide final cleaning. Conduct cleaning and waste-removal operations to comply with local laws and ordinances and Federal and local environmental and antipollution regulations.
- B. Cleaning:
 - 1. Complete the following cleaning operations before requesting inspection for certification of Substantial Completion for entire Project or for a portion of Project:
 - a. Clean Project site, yard, and grounds, in areas disturbed by construction activities, including landscape development areas, of rubbish, waste material, litter, and other foreign substances.
 - b. Sweep paved areas broom clean. Remove petrochemical spills, stains, and other foreign deposits.
 - c. Rake grounds that are neither planted nor paved to a smooth, even-textured surface.
 - d. Remove tools, construction equipment, machinery, and surplus material from Project site.
 - e. Clean exposed exterior hard-surfaced finishes to a dirt-free condition, free of stains, films, and similar foreign substances. Avoid disturbing natural weathering of exterior surfaces. Restore reflective surfaces to their original condition.
 - f. Remove debris and surface dust from limited access spaces, including roofs, plenums, shafts, trenches, equipment vaults, manholes, attics, and similar spaces.
 - g. Clean transparent materials, including mirrors and glass in doors and windows. Remove glazing compounds and other noticeable, vision-obscuring materials. Replace chipped or broken glass and other damaged transparent materials. Polish mirrors and glass, taking care not to scratch surfaces.
 - h. Touch up and otherwise repair and restore marred, exposed finishes and surfaces. Replace finishes and surfaces that cannot be satisfactorily repaired or restored or that already show evidence of repair or restoration.
 - i. Leave Project clean and ready for occupancy.
- C. Comply with safety standards for cleaning. Do not burn waste materials. Do not bury debris or excess materials on Owner's property. Do not discharge volatile, harmful, or dangerous materials into drainage systems. Remove waste materials from Project site and dispose of lawfully.

END OF SECTION 017700

SECTION 027800 – BELGIAN BLOCK UNIT PAVING

PART 1 - GENERAL

1.1 SECTION REQUIREMENTS

- A. Submittals: Samples for selecting unit pavers.

PART 2 - PRODUCTS

2.1 UNIT PAVERS

- A. Rough-Stone Pavers: Rectangular “Belgian Block” tumbled paving stones, with split faces and edges, made from granite complying with ASTM C 615.

2.2 AGGREGATE SETTING-BED MATERIALS

- A. Graded Aggregate for Base: Sound crushed gravels, ASTM D 448, Size No. 8.
- B. Sand for Leveling Course: ASTM C 33, fine aggregate.
- C. Sand for Joints: Fine, sharp, washed sand or crushed stone with 100 percent passing the No. 16 sieve and no more than 10 percent passing the No. 200 sieve.

PART 3 - EXECUTION

3.1 INSTALLATION, GENERAL

- A. Compact prepared subgrade surface and correct deficiencies before installing unit pavers.
- B. Cut unit pavers with masonry saw or block splitter.
- C. Tolerances: Do not exceed 1/16-inch unit-to-unit offset (lippage) nor 1/4 inch in 10 feet from level or indicated slope.

3.2 AGGREGATE SETTING-BED PAVER INSTALLATION

- A. Place aggregate base and compact with plate vibrator.
- B. Place sand for leveling course to a thickness of 1 to 1-1/2 inches.
- C. Set pavers with a minimum joint width of 1/16 inch and a maximum of 1/8 inch.

- D. Vibrate pavers into leveling course with at least 3 passes of a low-amplitude plate vibrator capable of a 3500- to 5000-lbf compaction force at 80 to 90 Hz.
- E. Spread dry sand and fill joints immediately after vibrating pavers into leveling course. Vibrate pavers and add sand until joints are completely filled, then remove excess sand.
- F. Repeat joint-filling process 30 days later.

END OF SECTION 027800

SECTION 029300 - LANDSCAPING AND PLANTINGS

1.01 SCOPE OF WORK

- A. The work to be done under this section shall require the Contractor to provide all labor, material, equipment and transportation necessary for the furnishing and planting of new trees, shrubs and groundcovers for both interior and exterior, free-standing and built-in, planters as shown on the Contract Drawings and as specified herein.

1.02 APPLICABLE SPECIFICATIONS AND STANDARDS

- A. STANDARDIZED PLANT NAMES, 1942 Edition, American Joint Committee on Horticultural Nomenclature.
- B. AMERICAN STANDARD FOR NURSERY STOCK, Z 60.1, latest edition, American Association of Nurserymen.
- C. Standards of the Association of Official Agriculture Chemists regarding soil analysis.
- D. United States Department of Agriculture – ‘Soil Classification System’.

1.03 SUBMITTALS

- A. Submittals: Product certificates and planting schedule.
- B. Inspection certificates for plant materials, as required by governmental agencies, shall be submitted to the Engineer.
- C. Provide quality, size, genus, species, and variety of exterior plants indicated, complying with applicable requirements in ANSI Z60.1, "American Standard for Nursery Stock."

1.04 PERSONNEL QUALIFICATIONS

- A. The planting shall be done by contractors regularly engaged in landscape construction work, specifically planting installation, and by skilled workers, trained and experienced in accepted horticultural/nursery practices. The work shall be done under the supervision of a qualified planting foreman. Plant installer shall have a minimum of three (3) years of experience in the landscape contracting profession and be able to provide references to the Owner of past related project work.

1.05 TRANSPORTATION, DELIVERY, STORAGE AND HANDLING

- A. Each plant shall be handled and packed in the approved manner for that species or variety and all necessary precautions shall be taken to insure that the plants arrive on-site in proper condition for successful growth. Trucks used for transporting plants shall be

equipped with covers to protect plants from windburn during transport.

- B. No plants shall be transported to the planting site that are not thoroughly wet through the ball of earth surrounding the roots. Any plants that are dry or in a wilted condition when delivered to the site will not be accepted and shall be replaced by the Contractor at his expense.
- C. Plants shall be delivered only after preparations for planting have been completed. They shall be planted immediately upon arrival to the site. If planting is delayed more than six (6) hours after delivery, plants shall be heeled in, protected from sun, wind, weather and mechanical damage, and kept watered.
- D. Packaged materials shall be delivered to the site in original unopened packaging showing weight, analysis and the name of the manufacturer.

PART II – MATERIALS

2.01 LOAM BORROW

- A. Loam shall be of a uniform composition throughout without admixture of subsoil, and shall be clean and reasonably free from clay, lumps, stones, roots two (2) inches or more in diameter, or other similar substances. Loam shall not contain toxic substances harmful to plant growth. It shall be free of weeds, weed seeds and debris, or other objects that might hinder planting operations.
- B. Loam shall have a pH value range between 5.0 and 7.0. If the soil does not fall within the pH range specified, it may be amended to bring it within the specified limit.
- C. Loam shall not contain less than four percent (4%) nor more than twenty percent (20%) organic matter, as determined by the loss ignition of samples oven-dried at a constant weight at a temperature of 230°F, ± 9°F.
- D. Loam shall not be worked, excavated or delivered while in a frozen or muddy state.

2.02 PREPARED PLANTING MIX

- A. The prepared planting soil mix for all plant bed areas shall consist of the following materials and quantities:
 - 1. One (1) part organic compost, humus, or peat borrow as specified in the NH Standard Spec.
 - 2. Seven (7) parts loam borrow.
 - 3. To this mixture add fertilizer and/or soil amendments in accordance with the recommendations of the soils testing laboratory.

2.03 SOIL AMENDMENTS

- A. The Contractor shall be encouraged to use materials that are naturally occurring, derived from renewable resources, and non-toxic. Alternative materials and products shall be permitted provided that the specifications and application information are submitted to the Engineer for approval prior to use.

2.04 WATER

- A. Water may be available at the site for use, but can not be guaranteed. Costs associated with use of the water shall be born solely by the contractor. Hose and other equipment required for application of water shall be furnished by the Contractor.

2.05 MULCH

- A. Shredded softwood bark mulch shall be fibrous pliable slices, not exceeding one half (½) inch in width. It shall be ninety-eight percent (98%) organic matter with a pH range of 3.5 to 4.5 and a moisture content not to exceed thirty-five percent (35%). It shall be free of weeds, weed seeds, debris, phytotoxic compounds and materials harmful to plant growth and viability. Organic mulch shall be aged not longer than two (2) years.
- B. Contractor to supply sample to Owner's Representative for approval. Dark, un-dyed, mulch color is preferred.

2.06 TREES

- A. Tress to be: **2"-3" caliper, Japanese Flowering Cherry (Prunus x yedoensis)**.
 - a. Quantity: Two (2)
 - b. Final location to be determined by Owner.
- B. Creeping Vines or Ivy to be: **3ft-4ft in height, Goldflame Honeysuckle (Lonicera x heckrottii)**. Final Location to be determined by Owner.
 - a. Quantity: Twenty Four (24)
 - b. Final location to be determined by Owner.

2.06 PLANT MATERIALS

- A. The Contractor shall furnish and plant all plants shown on the drawings, as specified, and in quantities and sizes as designated herein. No substitutions will be permitted without approval.
- B. All plants shall be grown in nurseries that have been inspected by the appropriate State agency and have complied with the regulations thereof. All plants shall comply with Federal and State Laws requiring inspection for plant diseases and pest infestations. Inspection certification, as required by law, shall accompany each shipment of plants,

and certificates shall be submitted to the Engineer. The Contractor shall obtain clearance from the applicable Governing Agency, as required by law, before planting any plants delivered from outside the state in which they are to be planted. Evidence that such clearance has been obtained shall be submitted to the Engineer.

- C. All plants shall conform to the American Standard for Nursery Stock of the American Association of Nurserymen, publication Z60.1. All trees and plants shall be typical of their species or variety and shall have a normal habit of growth.
- D. The root system of each plant shall be well provided with fibrous roots. All parts shall be sound, healthy, and vigorous, well branched and densely foliated when in leaf. They shall be free of disease, insect pests, eggs or larvae.
- E. The Contractor shall take note that only plant stock grown specifically for hardiness in Zone 6a of the 2012 USDA Plant Hardiness Zone Map, will be accepted. The Contractor's suppliers must certify in writing that the stock has actually been grown under Zone 6a conditions and is hardy, or that the stock was asexually propagated from and grafted onto stock from a strain proven hardy to Zone 6a conditions. Trees and shrubs not so certified may not be accepted.
- F. Balled and Burlapped Plants
 - 1. All plants designated balled and burlapped or 'B & B' must be moved with the root systems as solid units with balls of earth firmly wrapped with biodegradable burlap and bound carefully with twine or cord. The diameter and depth of the balls of earth must be sufficient to encompass the fibrous root feeding system necessary for the healthy development of the plant. No plant shall be accepted when the ball of earth surrounding its roots has been badly cracked or broken preparatory to or during the process of planting, or after the burlap, staves, ropes or platform required in connection with its transplanting have been removed. The plants and root balls shall remain intact as a unit during all planting operations. All plants shall be freshly dug. No plants from cold storage or previously heeled-in will be accepted.
 - 2. Soil characteristics (i.e., composition, texture, pH, etc.) of all field-grown balled and burlapped plants shall closely match that of the soil where plant materials are to be planted.
 - 3. All balled and burlapped plants that cannot be planted at once must be heeled in, protected and watered
- G. Container Grown Plants
 - 1. All container grown plants shall be well established in the container in which they are sold and shall have been have acclimatized for at least one (1) growing season. Plants shall have a fibrous, healthy root system with sufficient roots to

hold earth intact after removal from the container. Plants shall have no girdling roots and shall not be in a root bound condition. Plants shall remain in their container until planted.

2. Container plants shall not be broken up prior to installation.

2.07 STAKING MATERIALS

- A. Stakes for trees shall be wooden, and four (4) placed around each tree planted. Stakes shall be adequately sized to adequately support the caliper of the tree.
- B. Flexible braided nylon webbing shall be ‘Arbortie’, or approved equal. Nylon webbing shall be three-quarters ($\frac{3}{4}$) inch wide and have a tensile strength of nine hundred (900) pounds.

2.08 ANTITRANSPIRANTS

- A. Antitranspirant shall be ‘Wilt-Pruf’, manufactured by Nursery Specialty Products, Inc., Groton Falls, New York, or approved equal. It shall be delivered in the manufacturer’s containers and used in accordance with the manufacturer’s instructions.

2.09 PESTICIDES

- A. No pesticide shall be used on-site without the knowledge and prior approval of the Engineer. Pesticides shall be E.P.A. registered and approved for use in public open spaces. All pesticides shall be handled by State licensed operators only, delivered in the manufacturer’s containers, and used in accordance with the manufacturer’s instructions.

PART III – EXECUTION

3.01 PLANT LOCATIONS

- A. All plant locations and outlines for planting beds shall be staked out on the ground and approved by the Engineer before any excavation is begun. If it is necessary to adjust any of the locations, because of unforeseen problems, the changes shall be under the direction of the Engineer and there shall be no extra charges for these adjustments.

3.02 PLANTING HOLE EXCAVATIONS

- A. Planting holes for trees shall be at least one (1) foot greater in diameter than the root ball. Planting holes shall not be deeper than the height of the root ball. The walls of the hole shall be sloped, wider at the top than at the bottom, and shall be scarified to eliminate glazing.

3.03 PLANTING TREES, SHRUBS AND GROWDCOVERS

A. Planting Restrictions: Plant during one of the following periods.

1. Spring Planting: May 15th to June 20th
2. Fall Planting: August 15th to October 15th

B. All ties, tags, rope, twine and/or other materials that would potentially girdle plant stems, trunks or branches shall be removed prior to planting.

C. Plants shall be moved being lifted by their root ball masses and shall be set to the lines and grades as shown in the contract drawings. All trees and shrubs shall be faced properly, plumbed straight and planted at the center of the planting pits, at the same level as they had been previously grown. Owner's Representative shall inspect final resting height and exposed trunk flare of all trees and shrubs prior to backfilling planting pits. Contractor shall make any necessary adjustments to meet approval of Owner's Representative.

D. Balled and Burlapped Trees and Shrubs

1. Root ball masses of balled and burlapped (B&B) plants shall not be disturbed, loosened, broken or otherwise damaged during planting operations. All tying materials, twine and ropes shall be cut off and removed. Biodegradable burlap shall be laid back and/or cut away from the top half of the ball. No burlap shall be pulled out from under the ball. Any and all non-biodegradable materials, synthetic and/or treated burlap, shall be entirely removed prior to planting. If a wire basket is present, the upper two-thirds (2/3) of the metal basket shall be cut away and removed. Do not remove the entire basket.

E. Container Grown Plants

1. Container plants shall be removed from the grow container before planting. If roots are densely matted, the outer root mass shall be scored, sliced vertically with a sharp knife to separate roots.

F. Groundcover Planting

1. All groundcover plants shall be evenly spaced to produce a uniform effect, and staggered in rows at intervals detailed in the contract drawings. Groundcover plants shall not be installed individually, but per container or as instructed by Owner. Owner shall inspect all groundcover layout prior to planting.

G. Planting pits shall be backfilled with the existing, unamended soil removed from the hole, or prepared soil mix, as specified in the contract drawings, in layers not to exceed eight (8) inches. Each layer is to be tamped firmly and watered to sufficiently settle the backfilled soil. When the pit is approximately two-thirds (2/3) backfilled, water deeply and thoroughly, allowing it to drain through undisturbed. Continue

backfilling and tamping in eight (8) inch layers until soil is at the level at which the plant was formerly grown. Water thoroughly and adjust soil level.

- H. At the time of planting, during backfill, install fertilizer at a depth of six (6) to eight (8) inches, equally spaced around the plant. Packets and/or granular applications shall be placed approximately three (3) inches away from the plant roots or root ball. Packets shall not be cut, ripped or otherwise damaged. If it becomes necessary to remove and replace dead or unhealthy plants, any damaged or broken packets shall be replaced.
 - 1. The Contractor shall follow the manufacturer's recommendation for fertilizer packets or granular applications to trees and shrubs.
- I. The planting mixture shall be spread around the plant to form a temporary saucer, a minimum of three (3) inches deep and equal to the diameter of the planting hole. On slopes, a ridge of soil shall be formed on the downhill side to catch and hold water. Saucers shall not be formed around individual plants in planting beds.
- J. After all planting and watering, soil in planting beds shall be cultivated and raked smooth to eliminate compaction between the planting pits.
- K. All plants shall be flooded with water twice within the first twenty-four (24) hours from the time of planting.
- L. Immediately after planting operations are complete, all tree saucers and plant beds shall be covered with an approved mulch to a depth of no less than three (3) inches. Mulch shall not contact tree trunk bark, nor cover the root flare. No mulch shall be applied prior to the first watering.
- M. All thin barked, deciduous, non-evergreen trees shall be wrapped immediately after they are planted and before they are staked. Tree trunks shall be wrapped spirally from the bottom to the top with the specified wrapping material and secured. The wrapping shall overlap and completely cover the trunk from the ground to the height of the first branch and shall be neat and snug. Overlap shall be approximately two (2) inches. Wrapping shall be tied securely in place with jute twine.
- N. All trees shall be staked or guyed, in accordance with standard practice. Care shall be taken to ensure that the stakes do not pierce the root ball mass and that stakes and guying will not create pedestrian or vehicular hazards. Tree trunks shall be secured at one-third (1/3) the height of the tree with wire with hose and adjustable buckle, fastened to staking apparatus, and shall be approved by owner's representative. The Contractor shall remove all staking apparatus, stakes, and guys after one (1) growing season.
- O. Immediately after planting and staking, spray all plant material with an approved antitranspirant, applied in strict accordance with the manufacturer's recommendations.

3.04 PRUNING NEW PLANTS

- A. Trees and shrubs shall be pruned in accordance with American Association of Nurserymen Standards to preserve the natural character of the plant.
- B. Trees shall be pruned only after the plant has been completely planted. All large pruning cuts, one-half (1/2) inch diameter and larger, shall be made along the bark branch ridge. Pruning cuts shall not be made to breach or otherwise interfere with the branch collar. All pruning cuts less than one-quarter (1/4) inch diameter shall be made with a sharp pair of hand pruners as close to the main stem as possible without damaging the cambium or bud.
- C. All dead or dying limbs and tips, sucker growth, water sprouts, crossing or rubbing branches, broken or damaged branches, and/or diseased or insect infested limbs shall be removed. Questionable weak limb and branch removal that may disfigure the tree should be left for final approval by the Engineer.
- D. Never cut the tree leader.
- E. Any and all pruning shall be done with clean, sharp tools.
- F. Tree paint shall not be used to cover pruning cuts.

3.05 MAINTENANCE

- A. Maintain trees and shrubs until established, but not less than 6 months.
- B. Maintain ground covers and plants until established, but not less than 3 months.
- C. Maintenance shall begin immediately after each plant is planted and shall continue until final acceptance of the project.
- D. Maintenance shall consist of keeping plants in a healthy viable growing condition. Plants shall be watered, mulched, weeded, pruned, sprayed, fertilized, cultivated, and otherwise maintained and protected. Settled plants shall be reset to proper grade and position, planting saucer restored and dead material removed. Stakes and guys shall be tightened and repaired. Defective work shall be corrected as soon as possible after it becomes apparent and weather and season permit.
- E. Planting beds and individual plant pits shall be kept free of weeds. Mulch shall be replaced as required to maintain a three (3) inch depth. Beds and individual pits shall be neat in appearance and maintained to the original laid out lines.
- F. Planting areas that have been compacted for any reason during planting operations and/or the maintenance period, shall be recultivated by the Contractor, at his expense.

- G. Application of pesticides shall be included during the maintenance period, as required, with approved materials, at clearly announced and safe hours, by a State licensed pesticide operator.
- H. Sidewalks and other paved areas shall be kept clean during planting and maintenance operations.
- I. Upon completion of planting, excess soil and debris shall be removed from the site, and all damage resulting from planting operations shall be repaired.
- J. Planting areas and plants shall be protected against trespassing and damage of any kind for the duration of the maintenance period. This shall include the provisions and installation of approved temporary fencing if necessary. If any plants become damaged during the maintenance period, they shall be treated or replaced as directed by the Engineer, at no additional cost to the Owner.

3.06 GUARANTEE

- A. All trees, plantings, and groundcover shall be guaranteed for a period of 1 year from date of final acceptance. Plants shall exhibit satisfactory growth and have no less than seventy-five percent (75%) of their branches alive at the end of the guarantee period. If the leader of any single-leader species is dead, the entire plant shall be considered dead.
- B. All replacements shall be plants of the same kind and size specified on the Drawings and Specifications. They shall be furnished and planted as specified above. The cost shall be borne by the Contractor. Replacements resulting from the removal, loss or damage, vandalism or acts of neglect on the part of others, physical damage by animals, vehicles, etc., and losses due to curtailment of water by local authorities, will be approved and paid for by the Owner.
- C. At the end of the guarantee period, inspection will be made again. Any plant required under this Contract that is dead or unsatisfactory shall be removed from the site. These shall be replaced during the normal planting season, until the plants live through one (1) year.

END OF SECTION 029300

SECTION 055000 - METAL FABRICATION AND INSTALLATION

PART 1 - GENERAL

1.1 SECTION REQUIREMENTS

- A. Submittals: Shop Drawings showing details of fabrication and installation.

PART 2 - PRODUCTS

2.1 METALS

- A. Steel Plates, Shapes, and Bars: ASTM A 36/A 36M.
- B. Steel Tubing: Cold-formed steel tubing complying with ASTM A 500.
- C. Square Channel Posts: Cold-formed steel channels, 4 x 4 inches by 0.25 inch thick.

2.2 FABRICATION

- A. General: Fabricate metal parapet designed per Contract Drawings, from pre-formed steel or steel bent and molded, and prime at off-site at fabrication shop. Design & installation of parapet system to coordinate with the repair of rubber roof membrane, per attached Technical Specification section.
- B. General: Shear and punch metals cleanly and accurately. Remove burrs and ease exposed edges. Form bent-metal corners to smallest radius possible without impairing work.
- C. Welding: Weld corners and seams continuously. Use materials and methods that minimize distortion and develop strength and corrosion resistance of base metals. At exposed connections, finish welds and surfaces smooth with contour of welded surface matching those adjacent.
- D. Per Contract Drawings, fabricate 4" x 4" square steel pipe columns for parapet posts with 5/8-inch steel base plates welded to pipe with continuous fillet weld same size as pipe wall thickness. Drill base plates for 3/8-inch anchor bolts. Provide steel cap for square pipe columns.
- E. Prime and paint parapet system per attached Painting (099100) Specification section.
 - 1. Prime parapet system at off-site shop during fabrication.
 - 2. Paint parapet system on-site immediately after installation.

2.3 STEEL AND IRON FINISHES

- A. Prepare uncoated ferrous metal surfaces to comply with SSPC-SP 3, "Power Tool Cleaning," and paint with a fast-curing, universal zinc-rich primer.
- B. Finish: Factory-formulated satin or semi-gloss high performance oil based paint for exterior metal application.

PART 3 - EXECUTION

3.1 INSTALLATION

- A. Perform all field measurements as necessary in order to fabricate parapet system off-site.
- B. Perform cutting, drilling, and fitting required for metal fabrications in off-site shop, and have ready for future on-site installation of parapet system. Set parapet system together accurately in alignment, and elevation; with edges and surfaces level, plumb, true, and free of rack. Fit exposed connections accurately together to form hairline joints.
- C. Parapet steel rails to be riveted or welded together. Bolt or weld parapet rail and support system to square pipe columns.
- D. On-site: Fasten square pipe columns by bolting directly to concrete roof slab with drilled-in 3/8" diameter, stainless steel, high strength expansion anchors. Repair and install rubber roof membrane to provide a water tight seal, per attached Technical Specification section.
- E. Provide components required for a complete parapet assembly including trim, fascia, clips, seam covers, flashings, sealants, gaskets, fillers, closure strips, and similar items per the Contract Drawings.
- F. Paint parapet systems per attached Technical Specification section.

END OF SECTION 055000

SECTION 062000 - WOOD FENCING

PART 1 - GENERAL

1.01 SCOPE OF WORK

- A. The work to be done under this section shall require the Contractor to provide all labor, material, equipment and transportation necessary for the furnishing of a cedar board fence system with top cap rail, bottom rail, post caps, and necessary hardware per the contract drawings.
- B. Submittals: Shop Drawings; Submit three (3) copies to the Owner for review and approval.
 - 1. Wood fencing system with 8 foot long removable panel and gate system.
 - 2. Zinc coated hardware associated with fencing system.
- C. Forest Certification: Provide woodwork produced from wood obtained from forests certified by an FSC-accredited certification body to comply with FSC STD-01-001, "FSC Principles and Criteria for Forest Stewardship."

PART 2- PRODUCTS

2.01 GENERAL

- A. Furnish and install materials necessary to conform to design drawings for a smooth board, cedar, and stainable fence system as shown on plans. Fencing to be stained with product and color specified in the Contract Documents, or as specified by Owner.
- B. Submit three (3) copies of shop drawings to Owner for review prior to ordering fence system.

2.02 POSTS

- A. Posts as specified on the plans or in the contract. Posts are to be cedar treated, and set in concrete footings. Concrete footings to be twelve (12) inches in diameter and four (4) feet deep.

2.03 FENCE PANELS

- A. Furnish smooth board fence panels conforming to the layout the plans specify. Boards are to be 2.5" – 3.5" wide, with no gaps between. Panel sections lengths per Contract Drawings.
- B. Provide one (1) removable section of fencing that is eight (8) feet long, to be aligned with the existing underground vault on project site. The exact location

of removable fence section to be coordinated with Owner. Removable section of fencing to be set on zinc coated hangers attached to posts.

2.04 GATE

- A. Furnish and install cedar four (4) foot wide gate system as depicted on the Contract Drawings. Provide all hardware, including but not limited to hinges, thumb latch, strike, lock as necessary.
- B. Style to be confirmed with Owner and approved through shop drawings.

2.05 BOLTS, NUTS, AND HARDWARE

- A. Furnish all bolts, nuts, and miscellaneous hardware for the work according to the design and dimensions the plans show. Furnish sufficiently threaded bolts to allow secure fastening and supply with the necessary washers.
- B. Unless specified otherwise, furnish all bolts, nuts, washers and other hardware zinc coated.

PART 3 - INSTALLATION

3.01 GENERAL

- A. Construct all work according to the plan details specified for the work. Dig the post holes at the required location and depth, and compact the bottom of the holes to provide a stable foundation. The engineer will allow a tolerance of +/- 3 inches in depth, provided the post length is adequate to obtain the required elevation of the finished top. Set the posts plumb and with the front faces in a straight line or to conform to curves or angles the plans show or as the engineer directs. Backfill the placed posts with concrete, and avoid disturbing the position or alignment of the post.
- B. After setting the post, determine the finished elevation of the post top and cut off and trim as the plans show. Bolt the panels to the posts, unless specified otherwise, with 3/8" diameter zinc coated lag bolts.

END OF SECTION 062000

SECTION 064013 - EXTERIOR ARCHITECTURAL WOODWORK

PART 1 - GENERAL

1.1 SCOPE OF WORK

- A. The work to be done under this section shall require the Contractor to provide all labor, material, equipment and transportation necessary for the furnishing and installation of new trellis system on three (3) sides of the exterior of the building, as shown on the Contract Drawings and as specified herein.

1.2 SECTION REQUIREMENTS

- A. Submittals: Shop Drawings; Submit three (3) copies to the Owner for review and approval.
 - 1. Trellis System.
 - 2. Applied Preservative Treatment
- B. Forest Certification: Provide woodwork produced from wood obtained from forests certified by an FSC-accredited certification body to comply with FSC STD-01-001, "FSC Principles and Criteria for Forest Stewardship."

PART 2 - PRODUCTS

2.1 MATERIALS

- A. Preservative Treatment: Comply with WDMA I.S.4 for items indicated to receive water-repellent pressure preservative treatment.
- B. Fasteners for Exterior Woodwork:
 - 1. Epoxy Bolts: **hot-dip galvanized; ¼" diameter**
 - 2. Screws: **hot-dip galvanized or stainless steel; flat head.**

2.2 EXTERIOR WOODWORK

- A. Wood Moisture Content: **9 to 15** percent.
- B. Complete fabrication to maximum extent possible before shipment to Project site. Disassemble components only as necessary for shipment and installation. Where necessary for fitting at site, provide ample allowance for cutting, trimming, fitting, and mounting.
- C. Exterior Standing and Running Trellis Boards: Premium grade, made from eastern white pine, Douglas fir, sugar pine, or Idaho white pine. Wood to be pressure preservative treated.

- D. Apply preservative treatment to any cut surfaces, and especially to those cut surfaces installed in contact with brick, masonry, or the ground, and to end-grain surfaces.

PART 3 - EXECUTION

3.1 INSTALLATION

- A. Install woodwork to comply with referenced quality standard for grade specified.
- B. Install Trellis boards (battens) true and straight with no distortions on three (3) sides of building. Shim as required with concealed shims. Install level and plumb.
- C. Install Vertical and Horizontal Trellis boards (battens) at 9 inch spacing, per Contract Drawings. Trellis system to be constructed using screws as specified herein.
- D. Anchor trellis system to building through vertical boards (battens) using epoxy bolts as specified herein. Epoxy bolt spacing to be 3 feet o.c. vertically, with 3 epoxy bolts per vertical board; and 5 feet o.c. horizontally. Epoxy bolts to be anchored into the existing brick wall mortar joints, and not extend beyond the depth of mortar in the wall.
- E. Scribe and cut woodwork to fit adjoining work, and treat cut surfaces with preservative at cuts.
- F. Vertical and Horizontal Boards (Battens): Install with minimum number of joints possible, using full-length pieces (from maximum length of lumber available) to greatest extent possible. Do not use pieces less than 36 inches long, except where shorter single-length pieces are necessary. Stagger joints in adjacent and related members, and affix with screws at end of lumber pieces.

END OF SECTION 064013

SECTION 075323 - ETHYLENE-PROPYLENE-DIENE-MONOMER (EPDM) ROOFING

PART 1 - GENERAL

1.1 SUMMARY

- A. Furnish and install new, fully adhered .060 EPDM flashing around metal columns on the Mechanic Street Pump Station roof parapet system, and adhere to existing roof material.

1.2 SECTION REQUIREMENTS

- A. Submittals: Metal band; EPDM flashing membrane; and Sealant.
- B. Environmental Limitations: Do not proceed with installation of adhesives or joint sealants when ambient and substrate temperature conditions are outside limits permitted by manufacturer or are below 40 deg F.
- C. Warranties: Manufacturer's standard form, without monetary limitation, signed by roofing manufacturer agreeing to repair leaks due to defects in materials or workmanship for period of twenty (20) years.

PART 2 - PRODUCTS

2.1 ROOFING MATERIALS

- A. EPDM Sheet: ASTM D 4637, Type I, non-reinforced; 60 mils thick; black; fully adhered.
- B. Auxiliary Materials: Recommended by roofing system manufacturer for intended use and as follows:
 - 1. Sheet Flashing: 60-mil thick EPDM.
 - 2. Seaming Material: Single-component, butyl splicing adhesive and splice cleaner.
 - 3. Flashing Strap: Aluminum flashing strap around each column of the parapet system.

2.2 ROOF INSULATION

- A. Polyisocyanurate Board Tapered Insulation: ASTM C 1289, Type II.
 - 1. Install as necessary to fill voids created by parapet column footing installations.

PART 3 - EXECUTION

3.1 INSTALLATION

- A. No portion of roof may be left open, exposed, or uncovered to the weather for any period of time other than when work is being performed.
- B. Roof Ballast Stones: Remove ballast as necessary to install parapet column and footings; then reuse & redistribute ballast rocks to match previously existing condition.
- C. Furnish and install insulation after parapet footing is installed, and mechanically fasten to existing roof deck. Tightly butt insulation boards together and against metal column.
- D. Furnish and install fully adhered EPDM flashing membrane according to roofing system manufacturer's written instructions and as follows:

1. Extend EPDM flashing up and around metal parapet column a minimum of 6 inches above existing roof elevation; and extend 12 inches onto existing roof membrane. Apply sealant recommended for EPDM roof systems at seams as necessary, per manufacture's specifications
 2. Adhered Sheet Installation: Apply bonding adhesive to insulation, metal parapet column, and underside of flashing membrane and allow to partially dry.
- E. Furnish & Install 1 inch wide aluminum flashing strip around each column of parapet system. Flashing strip to be positioned around top of EPDM flashing membrane, and mechanically fastened to column.
1. Prior to installation of aluminum flashing strip apply sealant recommended for EPDM roof systems between new EPDM flashing and metal column substrate, at elevation of new aluminum flashing strip to provide a waterproof seal.
 2. Apply sealant recommended for EPDM roof systems along top of EPDM flashing membrane to provide additional layer of waterproofing, per manufacturer's specifications.
- F. Clean job site and remove all job related debris on a daily basis.

END OF SECTION 075323

SECTION 099100 - PAINTING

PART 1 - GENERAL

1.1 RELATED DOCUMENTS

- A. Drawings and general provisions of the Contract, including Division 1 Specification Sections, apply to this Section.
- B. Coordinate with Metal Parapet Section 055000.

1.2 SUMMARY

- A. This Section includes surface preparation and field painting of exposed exterior items and surfaces.
 - 1. The work of this section is intended to include paint on the new exterior metal parapet, associate parapet hardware, which includes:
 - a. One prime coat, two finish coats.
 - 2. The work of this section is intended to include stain on the new exterior wood fencing system, which includes:
 - a. Two finish coats.

1.3 DEFINITIONS

- A. General: Standard coating terms defined in ASTM D 16 apply to this Section.
 - 1. Flat refers to a lusterless or matte finish with a gloss range below 15 when measured at an 85-degree meter.
 - 2. Eggshell refers to low-sheen finish with a gloss range between 20 and 35 when measured at a 60-degree meter.
 - 3. Semi-gloss refers to medium-sheen finish with a gloss range between 35 and 70 when measured at a 60-degree meter.
 - 4. Full gloss refers to high-sheen finish with a gloss range more than 70 when measured at a 60-degree meter.

1.4 SUBMITTALS

- A. Product Data: For each primer, paint, and stain system indicated. Include block fillers and primers.
- B. Samples for Verification: For each color and material to be applied, with texture to simulate actual conditions, on representative Samples of the actual substrate.

1.5 QUALITY ASSURANCE

- A. Applicator Qualifications: A firm or individual experienced in applying paints and stains similar in material, design, and extent to those indicated for this Project, whose work has resulted in applications with a record of successful in-service performance.
- B. Source Limitations: Obtain block fillers and primers for each coating system from the same manufacturer as the finish coats.

1.6 DELIVERY, STORAGE, AND HANDLING

- A. Deliver materials to Project site in manufacturer's original, unopened packages and containers bearing manufacturer's name and label and the following information:
 - 1. Product name or title of material.
 - 2. Product description (generic classification or binder type).
 - 3. Manufacturer's stock number and date of manufacture.
 - 4. Contents by volume, for pigment and vehicle constituents.
 - 5. Thinning instructions.
 - 6. Application instructions.
 - 7. Color name and number.
 - 8. VOC content.
- B. Store materials not in use in tightly covered containers in a well-ventilated area at a minimum ambient temperature of 45 deg F. Maintain storage containers in a clean condition, free of foreign materials and residue.
 - 1. Protect from freezing. Keep storage area neat and orderly. Remove oily rags and waste daily.

1.7 PROJECT CONDITIONS

- A. Apply paints and stains only when temperatures of surfaces to be painted and surrounding air are between 50 and 90 deg F.
- B. Apply solvent-thinned paints and stains only when temperatures of surfaces to be painted and surrounding air are between 45 and 95 deg F.
- C. Do not apply paint or stains in snow, rain, fog, or mist; or when relative humidity exceeds 85 percent; or at temperatures less than 5 deg F above the dew point; or to damp or wet surfaces.

PART 2 – PRODUCTS

2.1 MANUFACTURERS

- A. Manufacturers' Names: Shortened versions (shown in parentheses) of the following manufacturers' names are used in other Part 2 articles:

1. Benjamin Moore & Co. (Benjamin Moore).
2. PPG Industries, Inc. (Pittsburgh Paints).
3. Sherwin-Williams Co. (Sherwin-Williams).

2.2 PAINT MATERIALS, GENERAL

- A. Primer – Exterior: Provide one (1) coat of rust-inhibitive specialty (zinc-rich) primer to prevent rust from occurring, or approved equal, to exterior metal parapet and associate parapet hardware.
- B. Paint – Exterior: Provide two (2) coats of semi-gloss high performance oil based paint for exterior metal application, or approved equal, to exterior metal parapet and associate parapet hardware.
- C. Material Compatibility: Provide block fillers, primers, and finish-coat materials that are compatible with one another and with the substrates indicated under conditions of service and application, as demonstrated by manufacturer based on testing and field experience.
- D. Material Quality: Provide manufacturer's best-quality paint material of the various coating types specified that are factory formulated and recommended by manufacturer for application indicated. Paint-material containers not displaying manufacturer's product identification will not be acceptable.
 1. Proprietary Names: Use of manufacturer's proprietary product names to designate colors or materials is not intended to imply that products named are required to be used to the exclusion of equivalent products of other manufacturers. Furnish manufacturer's material data and certificates of performance for proposed substitutions.
- E. Colors: Chosen by Owner from manufacturer's standard palette.

2.3 STAIN MATERIALS, GENERAL

- A. Material Compatibility: Provide block fillers and finish-coat materials that are compatible with one another and with the substrates indicated under conditions of service and application, as demonstrated by manufacturer based on testing and field experience.
- B. Material Quality: Provide manufacturer's best-quality stain material of the various coating types specified that are factory formulated and recommended by manufacturer for application indicated. Stain-material containers not displaying manufacturer's product identification will not be acceptable.
 1. Proprietary Names: Use of manufacturer's proprietary product names to designate colors or materials is not intended to imply that products named are required to be used to the exclusion of equivalent products of other manufacturers. Furnish manufacturer's material data and certificates of performance for proposed substitutions.

- C. Colors: Chosen by Owner from manufacturer's standard palette.

EXTERIOR FINISH COATS

- A. Exterior Oil Based Paint: Factory-formulated semi-gloss high performance oil based paint for exterior metal application.
 - 1. Sherwin Williams oil based exterior paint, or approved equivalent.
- B. Exterior Oil Based Stains: Factory-formulated satin or semi-gloss oil based stain for exterior fencing application.
 - 1. Cabot Semi-Solid Stains #6100 Series, or approved equivalent.

PART 3 – EXECUTION

3.1 EXAMINATION

- A. Examine substrates, areas, and conditions, with Applicator present, for compliance with requirements for paint or stain application as indicated by associated material type.
 - 1. Proceed with paint or stain application only after unsatisfactory conditions have been corrected and surfaces receiving paint or stain are thoroughly dry.
 - 2. Start of painting or staining will be construed as Applicator's acceptance of surfaces and conditions within a particular area.
- B. Coordination of Work: Review other Sections in which primers are provided to ensure compatibility of the total system for various substrates. On request, furnish information on characteristics of finish materials to ensure use of compatible primers.
 - 1. Notify Owner about anticipated problems when using the materials specified over substrates primed by others.

3.2 PREPARATION

- A. General: Provide surface-applied protection before surface preparation and painting or staining to protect surfaces not intended to be painted or stained.
- B. Cleaning: Before applying paint or stains, clean substrates of substances that could impair bond of the various coatings. Remove oil and grease before cleaning.
 - 1. Schedule cleaning and painting or staining so dust and other contaminants from the cleaning process will not fall on wet, newly painted or stained surfaces.
- C. Surface Preparation: Clean and prepare surfaces to be painted or stained according to manufacturer's written instructions for each particular substrate condition and as specified.

1. Remove rust spots as necessary, if rust has developed before paint is to be applied.
- D. Material Preparation: Mix and prepare paint and stain materials according to manufacturer's written instructions.
1. Maintain containers used in mixing and applying paint and stain in a clean condition, free of foreign materials and residue.
 2. Stir material before application to produce a mixture of uniform density. Stir as required during application. Do not stir surface film into material. If necessary, remove surface film and strain material before using.
 3. Use only thinners approved by manufacturers and only within recommended limits.

3.3 APPLICATION

- A. General: Apply paint or stain according to manufacturer's written instructions. Use applicators and techniques best suited for substrate and type of material being applied.
1. Use brushes only for exterior painting and staining and where the use of other applicators is not practical.
 2. Do not paint or stain over dirt, rust, scale, grease, moisture, scuffed surfaces, or conditions detrimental to formation of a durable paint or stain film.
 - a. **Metal parapet to be primed after fabrication in off-site shop, and brought to project site ready to receive paint immediately after installation. Coordinate with Metal Parapet Section 055000.**
 3. Provide finish coats that are compatible with primers used.
- B. Scheduling Painting: Apply first coat to surfaces that have been cleaned, pretreated, or otherwise prepared for painting as soon as practicable after preparation and before subsequent surface deterioration.
1. The number of coats and film thickness required are the same regardless of application method. Do not apply succeeding coats until previous coat has cured as recommended by manufacturer. If sanding is required to produce a smooth, even surface according to manufacturer's written instructions, sand between applications.
 2. If undercoats, stains, or other conditions show through final coat of paint, apply additional coats until paint film is of uniform finish, color, and appearance.
- C. Apply paints to produce surface films without cloudiness, spotting, holidays, laps, brush marks, roller tracking, runs, sags, ropiness, or other surface imperfections. Cut in sharp lines and color breaks.
1. If undercoats or other conditions show through topcoat, apply additional coats until cured film has a uniform paint finish, color, and appearance.

- D. Apply stains and transparent finishes to produce surface films without color irregularity, cloudiness, holidays, lap marks, brush marks, runs, ropiness, or other imperfections. Use multiple coats to produce a smooth surface film of even luster.
- E. Application Procedures: Apply paints, stains, and coatings by brush or other applicators according to manufacturer's written instructions.
 - 1. Brushes: Use brushes best suited for type of material applied. Use brush of appropriate size for surface or item being painted or stained.
- F. Minimum Coating Thickness: Apply paint materials no thinner than manufacturer's recommended spreading rate to achieve dry film thickness indicated. Provide total dry film thickness of the entire system as recommended by manufacturer.
- G. Prime Coats: Before applying finish coats, apply primer to areas that have been scratched or may be missing primer, as recommended by manufacturer before applications of finish coats. Recoat primed and sealed surfaces where evidence of suction spots or unsealed areas in first coat appears, to ensure a finish coat with no burn-through or other defects due to insufficient sealing.
- H. Pigmented (Opaque) Finishes: Completely cover surfaces as necessary to provide a smooth, opaque surface of uniform finish, color, appearance, and coverage. Cloudiness, spotting, holidays, laps, brush marks, runs, sags, ropiness, or other surface imperfections will not be acceptable.
- I. Completed Work: Match approved samples for color, texture, and coverage. Remove, refinish, repaint, or restrain work not complying with requirements.

3.4 CLEANING

- A. Cleanup: At the end of each workday, remove empty cans, rags, rubbish, and other discarded paint or stain materials from Project site.

3.5 PROTECTION

- A. Protect work of other trades, whether being painted or not, against damage from painting or staining. Correct damage by cleaning, repairing or replacing, and repainting, as approved by Owner. Provide "Wet Paint" signs to protect newly painted and stained finishes. After completing painting and staining operations, remove temporary protective wrappings provided by others to protect their work. After work of other trades is complete, touch up and restore damaged or defaced painted and stained surfaces.

END OF SECTION 099100

SECTION 165000 - LIGHTING

PART 1 - GENERAL

1.1 SECTION REQUIREMENTS

- A. Submittals: Product Data for each light fixture, including lamps.

PART 2 – PRODUCTS

2.1 LAMPS

- A. Light Emitting Diode (LED): 15W LED
- B. Comply with Dark Sky requirement limitations

2.2 REQUIREMENTS FOR INDIVIDUAL LIGHTING FIXTURES

- A. Fixture
 - 1. Basis-of-Design Product: Subject to compliance with requirements, provide **TMS Lighting; Hailey (#IP55); Product Code HYW0010-F-1-F16-GR330**
 - 2. Voltage: **120-V ac.**
 - 3. Mounting: **Surface (Exterior brick façade above door, in existing wall penetration)**
 - 4. Lamps: **LED**
 - 5. External Finish: **Black Anodized**
 - 6. Trim and Hardware: **To match fixture finish**
 - 7. Other Requirements: **Dark Sky Compliant.**

PART 3 - EXECUTION

3.1 INSTALLATION

- A. Set units level, plumb, and square with wall, and secure. Use existing wall penetration and wiring for mounting.
- B. Coordinate any electrical outages for installation of light fixture with Owner, one (1) day prior to necessary power outage.

END OF SECTION 165000



EXISTING VIEW



EXISTING VIEW

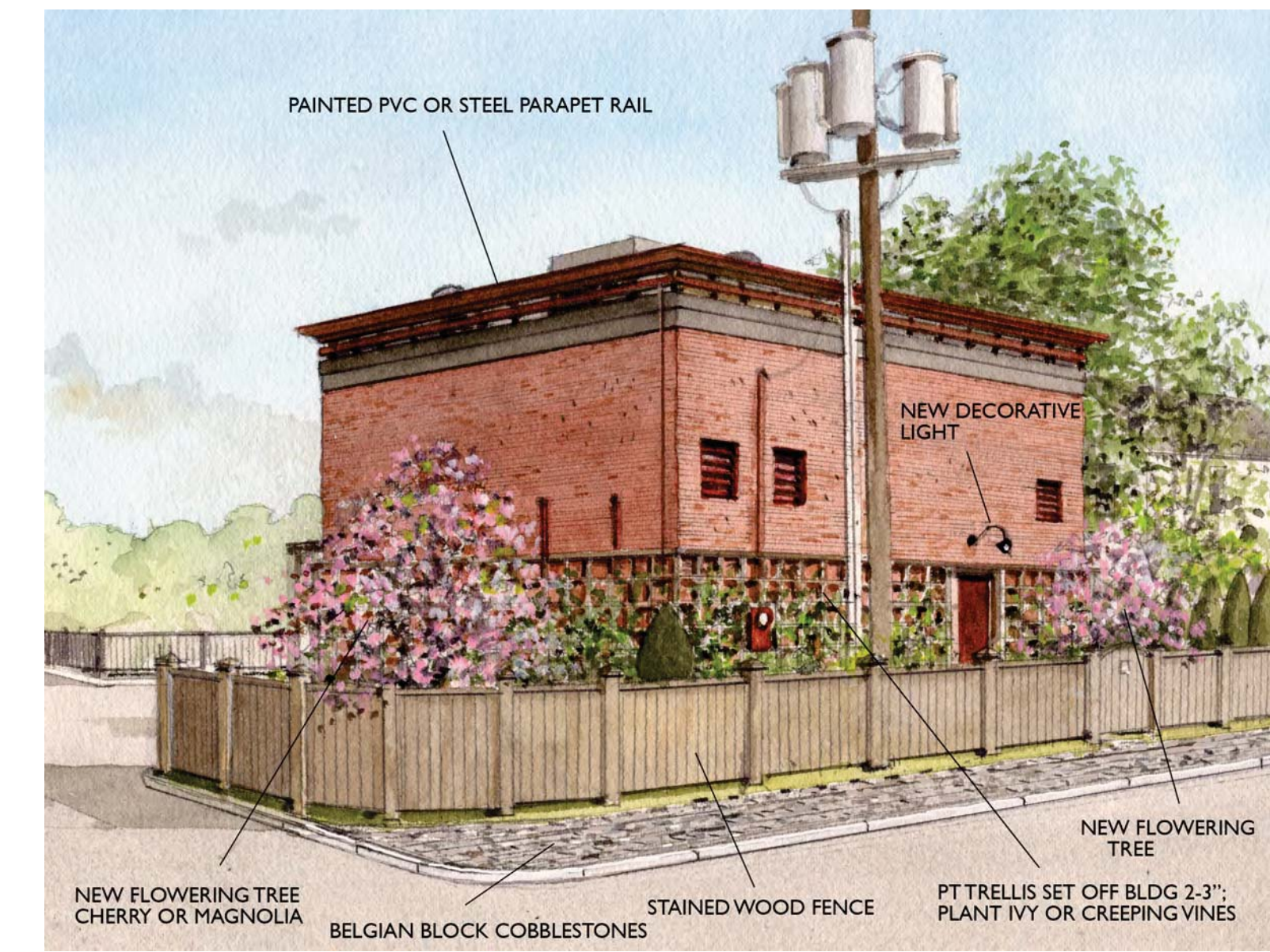

PROPOSED RENDERING PERSPECTIVE
(SOURCE: PLANNING DEPARTMENT)

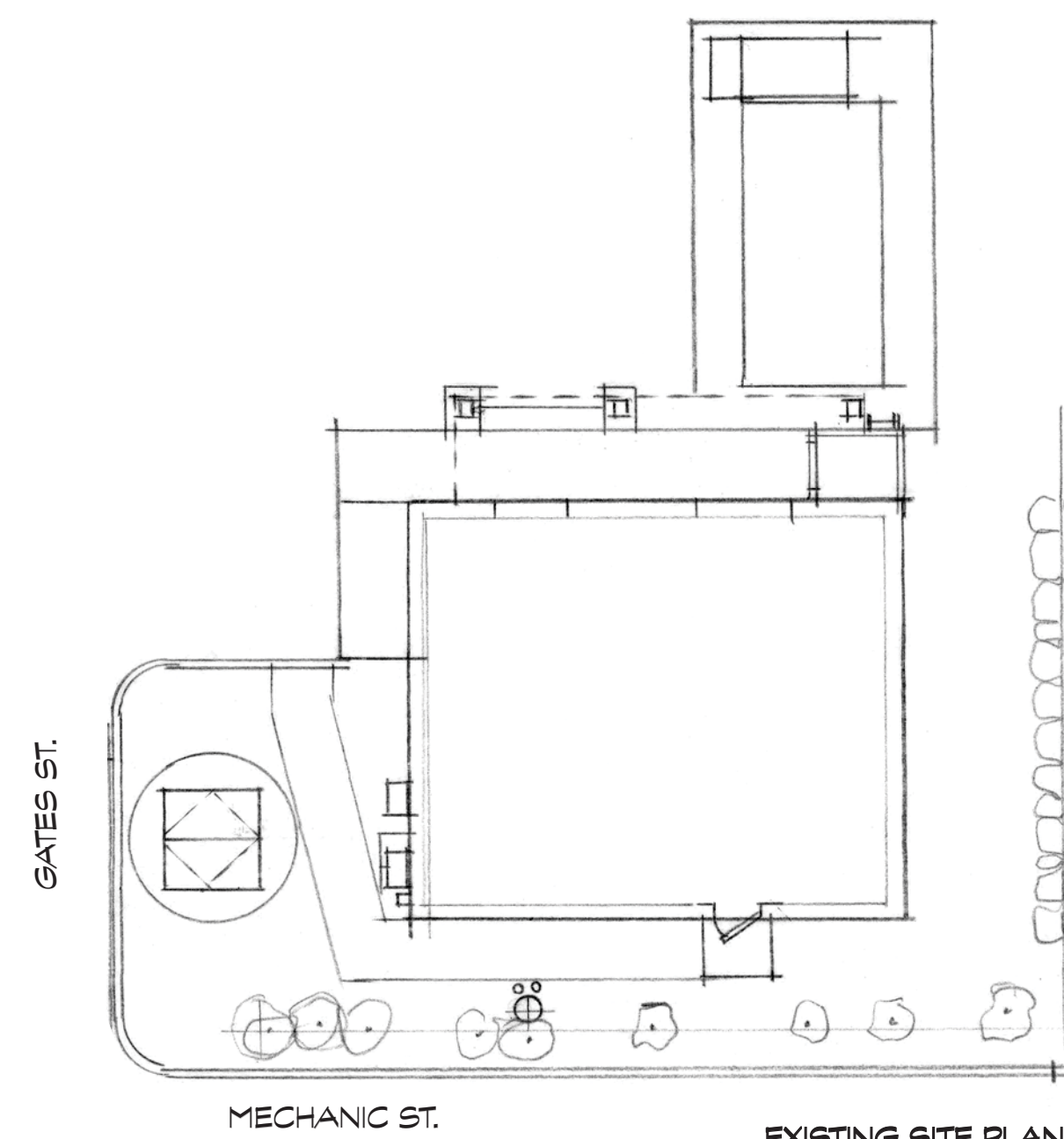

EXISTING SITE PLAN
1" = 1'-0" +/- SCALE

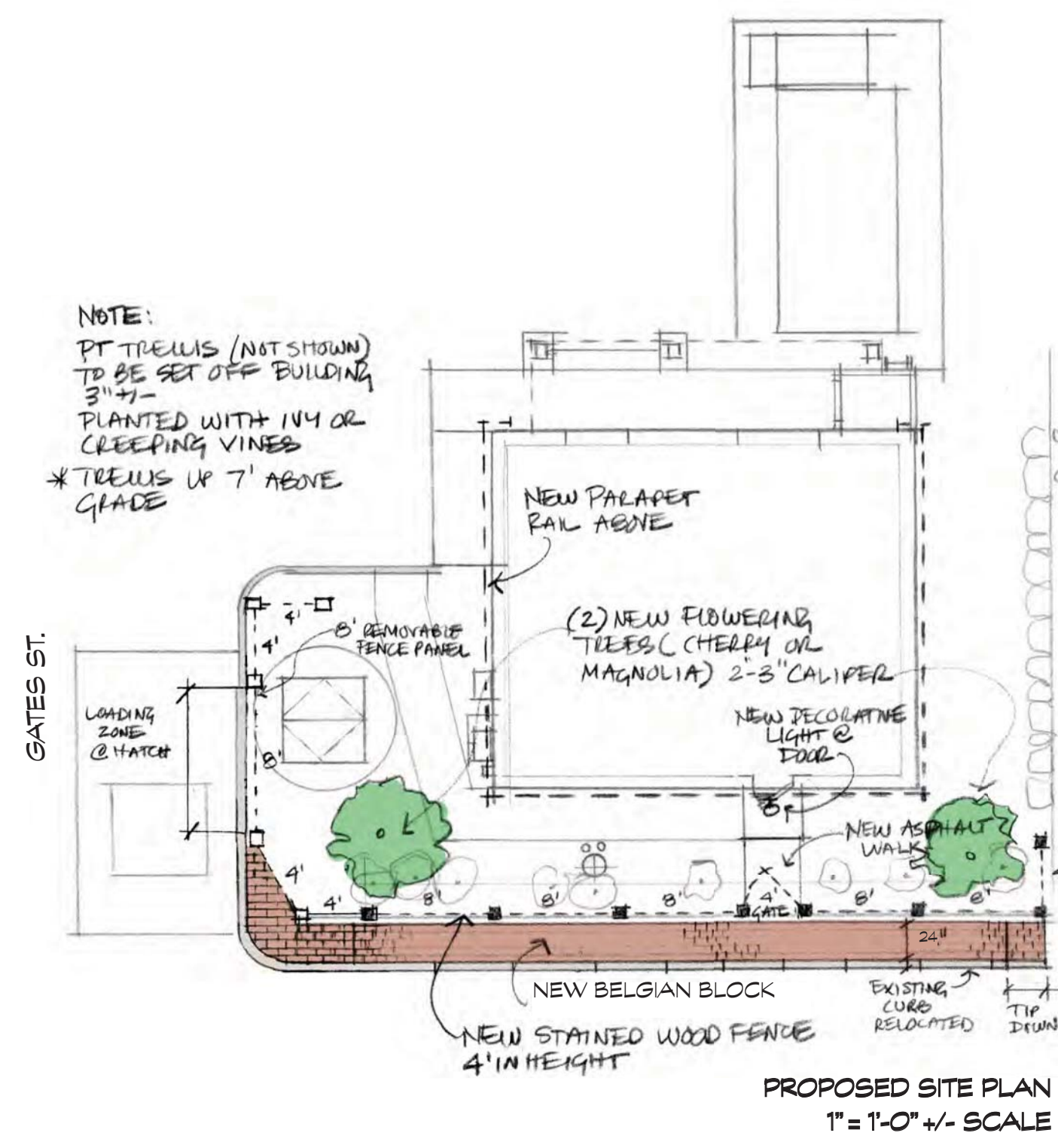

PROPOSED SITE PLAN
1" = 1'-0" +/- SCALE

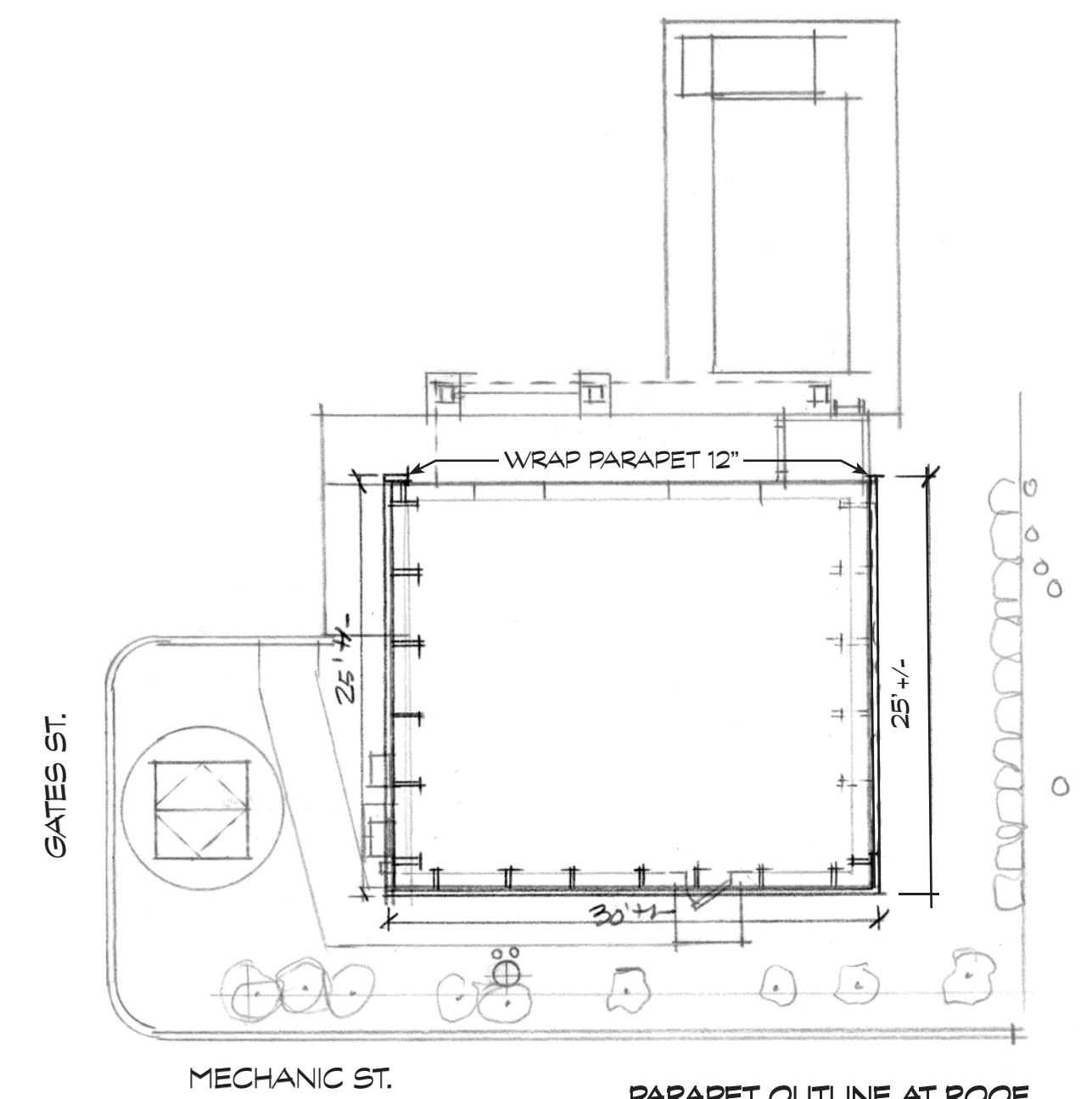

PARAPET OUTLINE AT ROOF
1" = 1'-0" +/- SCALE

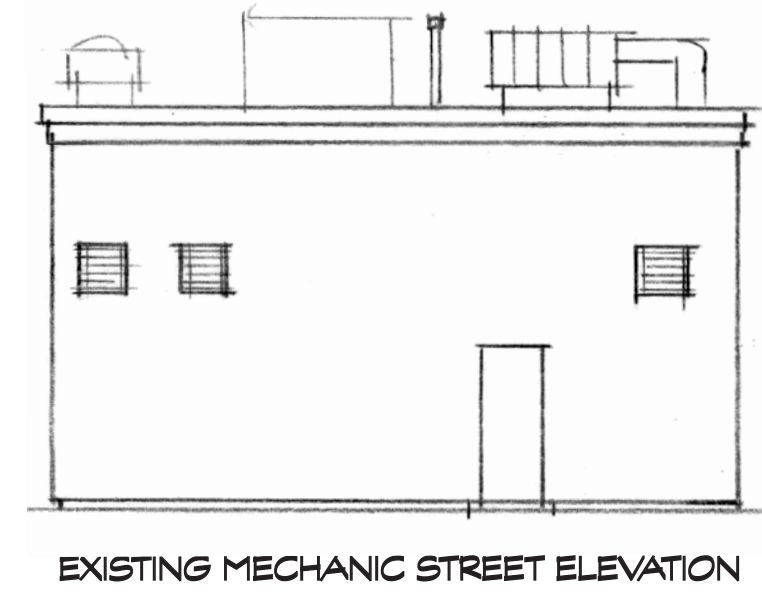

EXISTING MECHANIC STREET ELEVATION

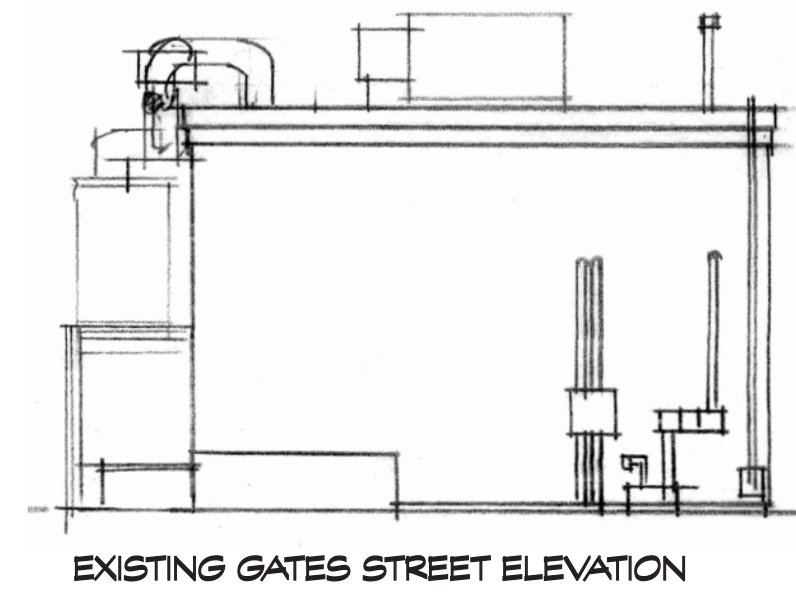

EXISTING GATES STREET ELEVATION

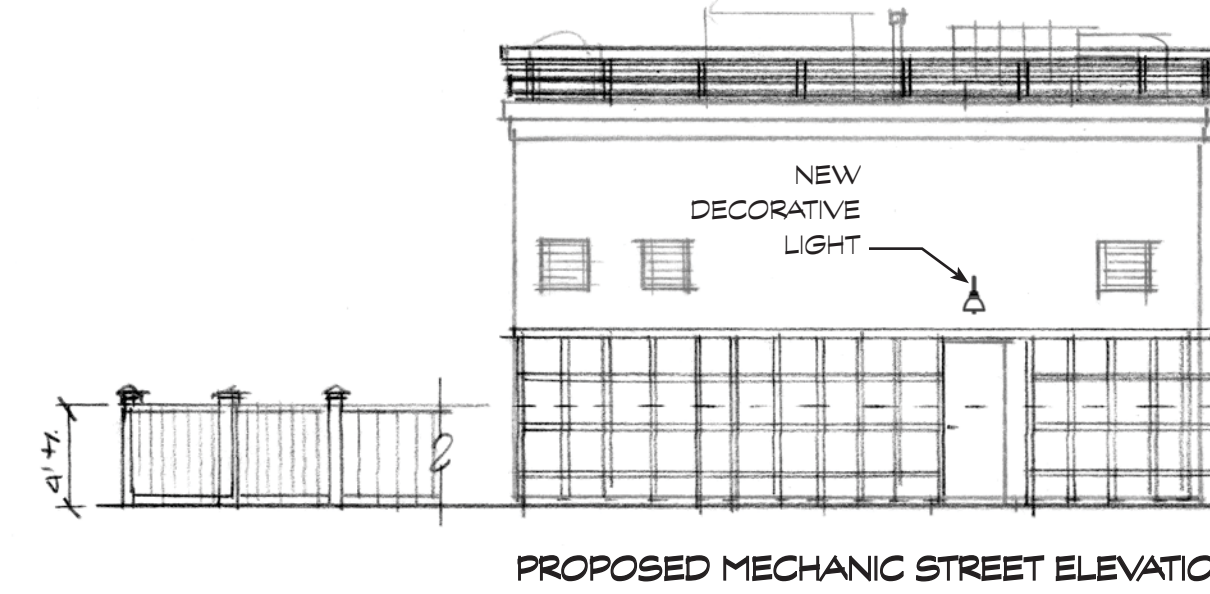

PROPOSED MECHANIC STREET ELEVATION

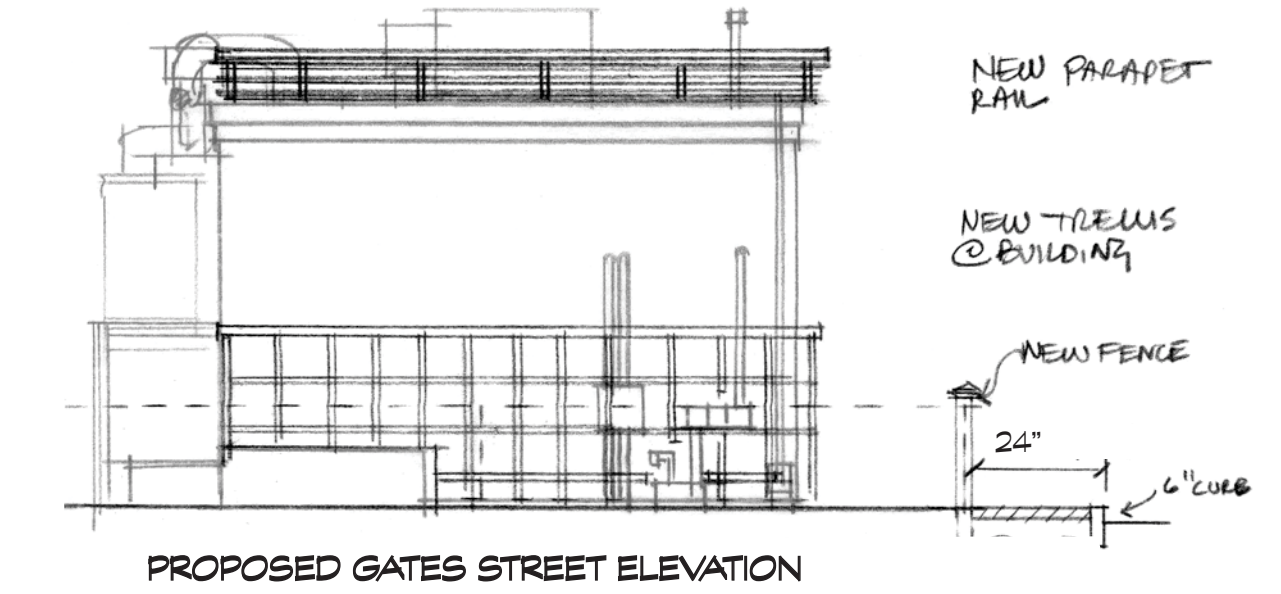

PROPOSED GATES STREET ELEVATION

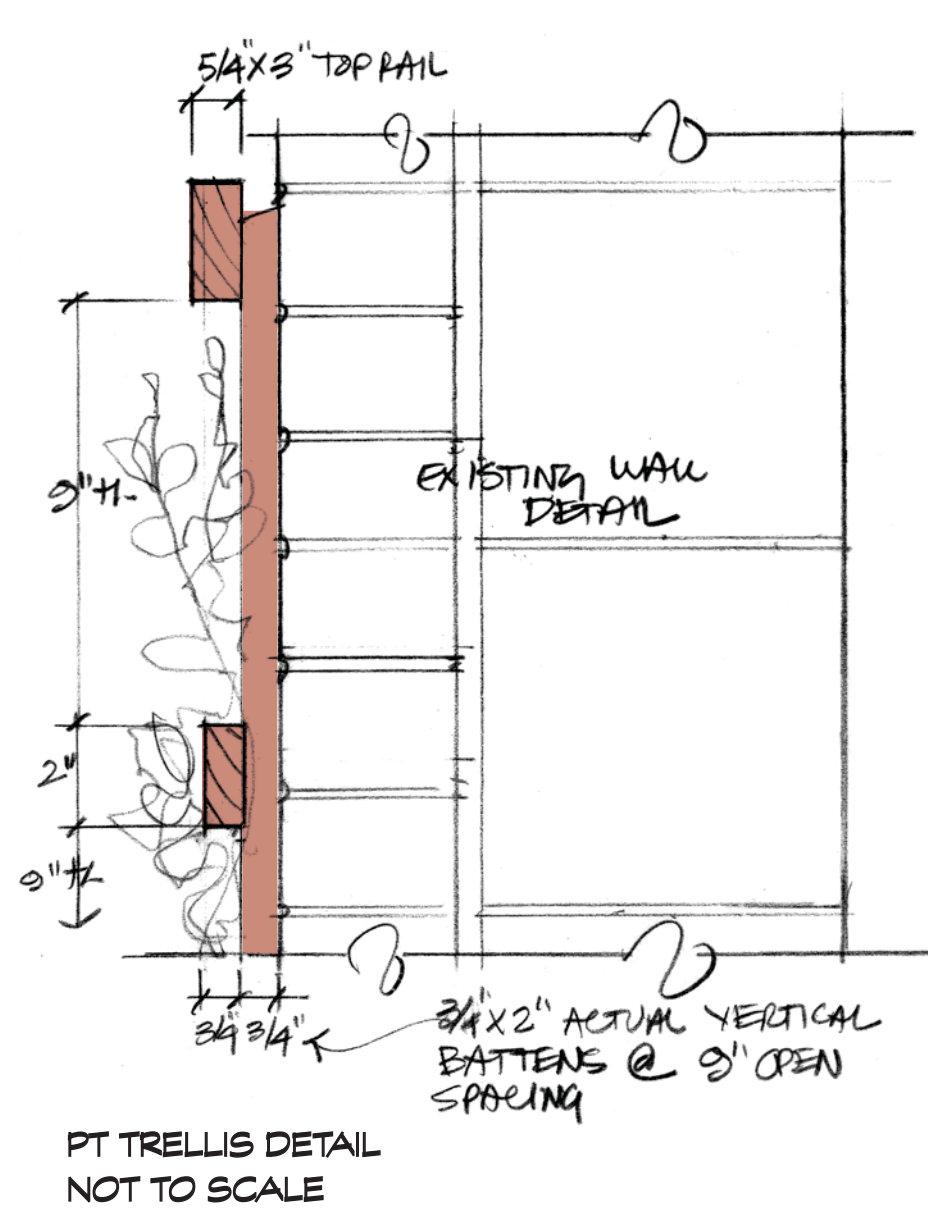

PT TRELLIS DETAIL
NOT TO SCALE

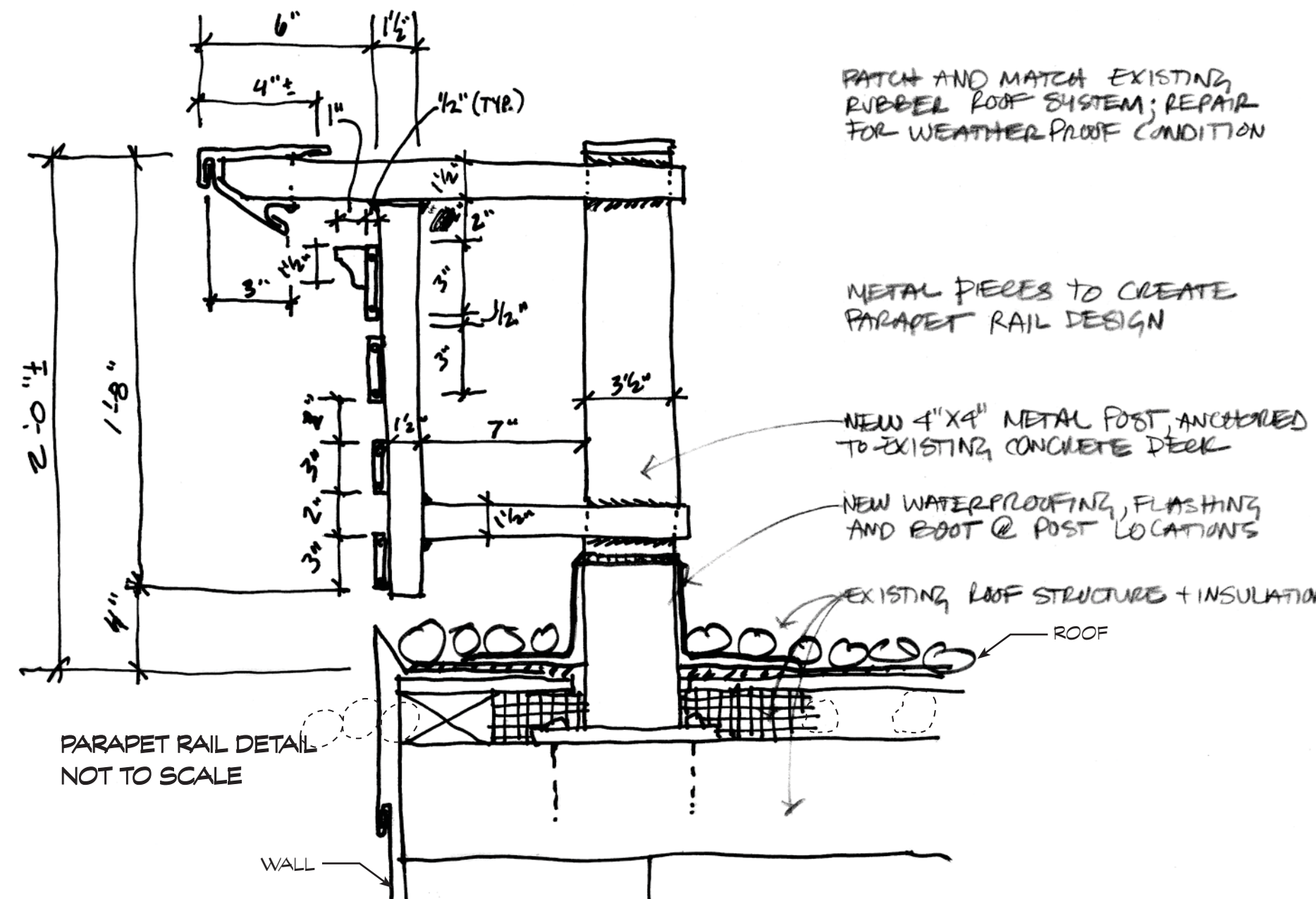

PARAPET RAIL DETAIL
NOT TO SCALE

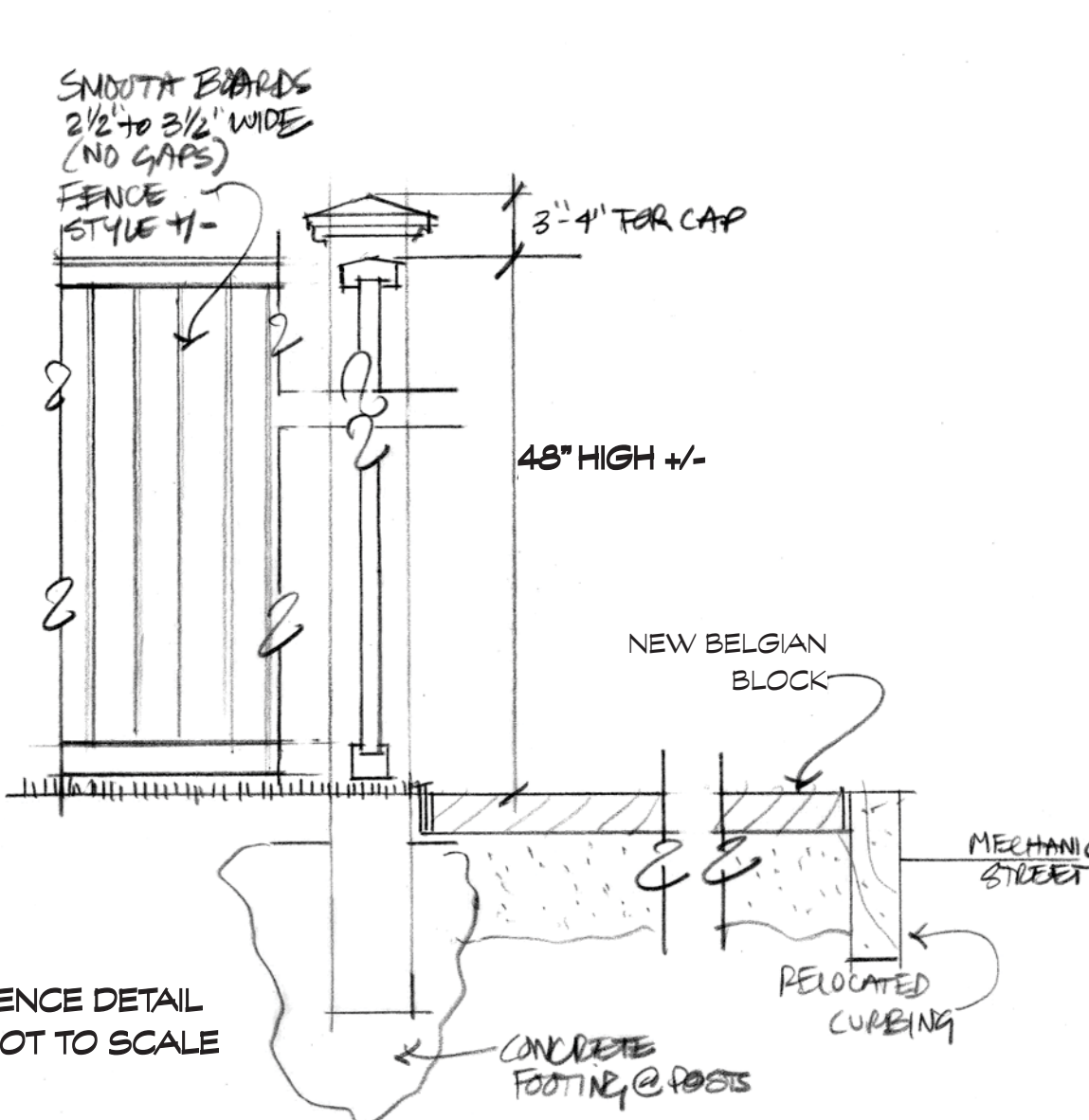

FENCE DETAIL
NOT TO SCALE



DOOR LIGHT DETAIL